

SPRINGBACK

2-POINT Spring-return actuator

3.10

Application

The JOVENTA **SPRINGBACK** electric, spring return damper-actuator series has been specially developed for the motorized operation of safety air dampers (anti-icing) in air conditioning systems, smoke evacuation dampers and sealing dampers.

When the control signal is applied the actuator drives the damper to the operational position, while evenly tensioning the integrated spring.

After a power failure the stored energy in the spring immediately brings the damper to the safety position.

Manual operation is automatically cancelled when the actuator is in electrical operation.

The compact design and universal adapter fitted with limitation of rotation angle make this JOVENTA actuator highly versatile.

Key features

- 2-point control
- Up to 5 actuators in parallel operation possible
- Plug-in terminal block connection
- Simple direct mounting with universal adapter on Ø 10 mm to 20 mm shaft or 10 mm to 16 mm square shaft.
77 mm min shaft length
- Selectable direction of rotation
- Limitation of rotation angle
- Manual positioning with crank handle
- 2 adjustable auxiliary switches
See back page for settings
- Automatic shut-off at end position (overload switch)
- Energy saving at end positions
- Actuators available with 1 m halogen-free cable
- Customized versions available
- Devices meet CE requirements

Accessories

- ZK damper linkage selection
 - ZKG ball joints
- (see data sheet 6.10)

Nomenclature/Specification/Technical data

DA1.F	AC/DC24V	
DA1.FS	AC/DC24V	with 2 auxiliary switches
DA2.F	AC230V	
DA2.FS	AC230V	with 2 auxiliary switches
. K		with 1 m halogen-free cable

Actuator	DA1.F(S)	DA2.F(S)
Torque	16 Nm	16 Nm
Damper area*	3.0 m ²	3.0 m ²
Running time Motor	90...120 s	90...120 s
Running time Spring return	10 s	10 s
Supply voltage	AC/DC24V	AC230V
Frequency	50-60 Hz	50-60 Hz
Power consumption		
- Running	10.0 W	8.0 W
- At end position	4.0 W	4.5 W
Dimensioning	18.0VA / 4A @ 2 ms	13.0VA / 0.3A @ 2 ms
Weight	2.7 kg	2.9 kg
Control signal	2-point	
Position signal	None	
Angle of rotation / working range	90° (93° mech.)	
Angle of rotation / limitation	0°...30° and 90°...60°	
Service lifetime	60,000 rotations	
Auxiliary switches	3(1.5)A, AC230V	
Setting range / adjustable	5°...85° < infinity	
Noise level	50 dB (A)	
Protection class	II	
Degree of protection	IP 54	
Cable aperture connection	PG11	
Mode of action	Type 1	
Ambient conditions		
- Operating temperature	-20...+50°C / IEC 721-3-3	
- Storage temperature	-30...+60°C / IEC 721-3-2	
- Humidity	5...95% r.F.	
Service	Maintenance-free	
Standards	Mechanics	EN 60 529 / EN 60 730-2-14
	Elektronics	EN 60 730-2-14
	EMC Emissions	EN 50 081-1:92 / IEC 61 000-6-3:96
	EMC Immunity	EN 50 082-2:95 / IEC 61 000-6-2:99

SPRING BACK

2-POINT Spring-return actuator

3.10

Wiring diagram DA1.F(S)/DA2.F(S)

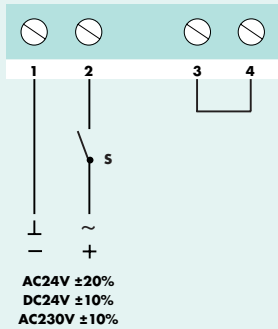

Parallel connection

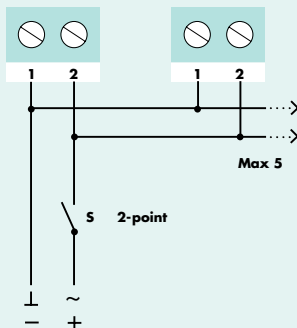

Auxiliary switches (S)

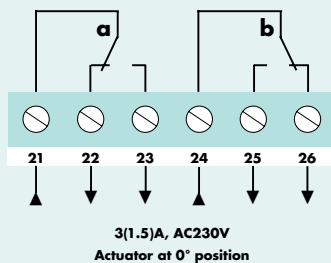

Angle of rotation

The 90° angle of rotation/working range can, through segments 1 and 2, be reduced by up to 30° from both end positions.

Dimensions in mm

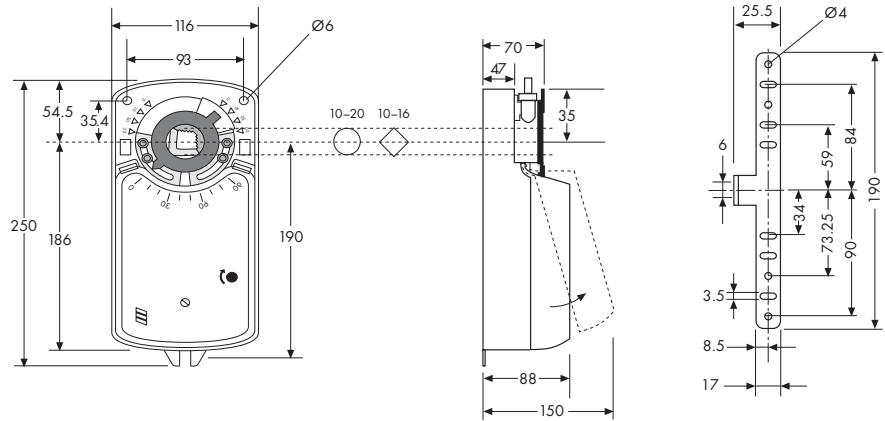

Changing the direction of rotation

The change in rotation direction is achieved by removing the adapter bush from one side and replacing it in the other side.

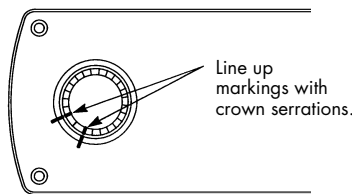

Factory setting:
Clockwise rotation.

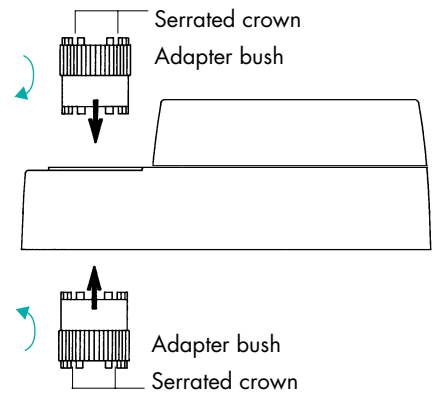

Auxiliary switch setting

Factory setting
Switch **a** at 10°
Switch **b** at 80°

The switching position can be manually changed to any required position by turning the ratchet.

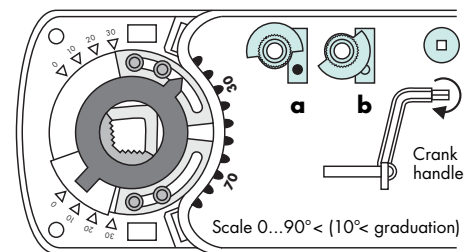

Limitation of rotation angle

Segment 1
Segment 2

