



P-NP Series
Frames 80-800

Antriebe Neumann GmbH

Parkstrasse 50 • 61231 Bad Nauheim

Tel.: 06032 - 6079383

Fax: 06032 - 6079384

info@neumann-antriebe.de

www.neumann-antriebe.de

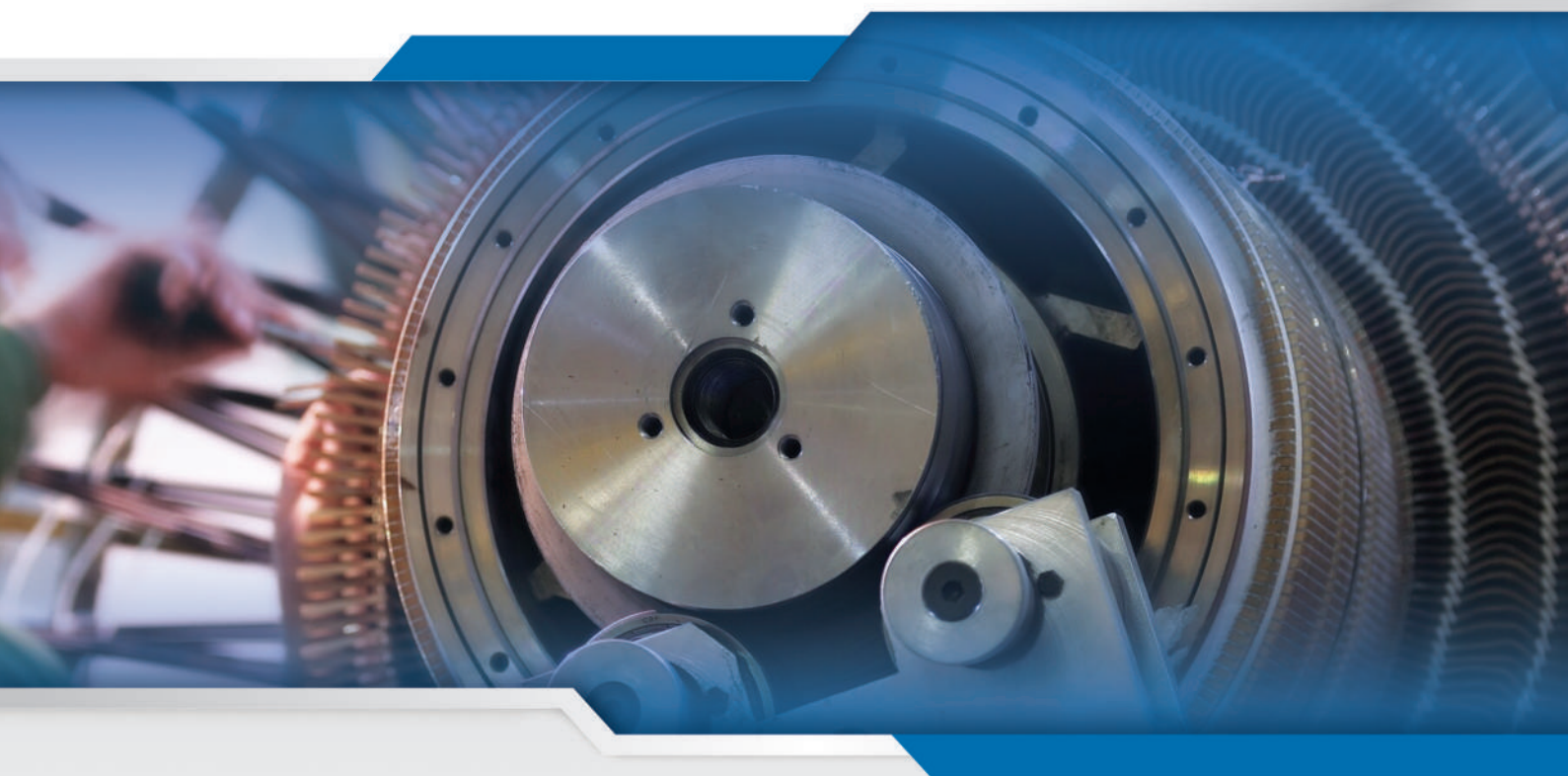
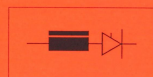

DC motors

Technical catalogue

C-GENDC-E-14

D.C. MOTORS FOR INDUSTRIAL APPLICATIONS

P – NP SERIES
Frames 80-800

GENERAL DESCRIPTION

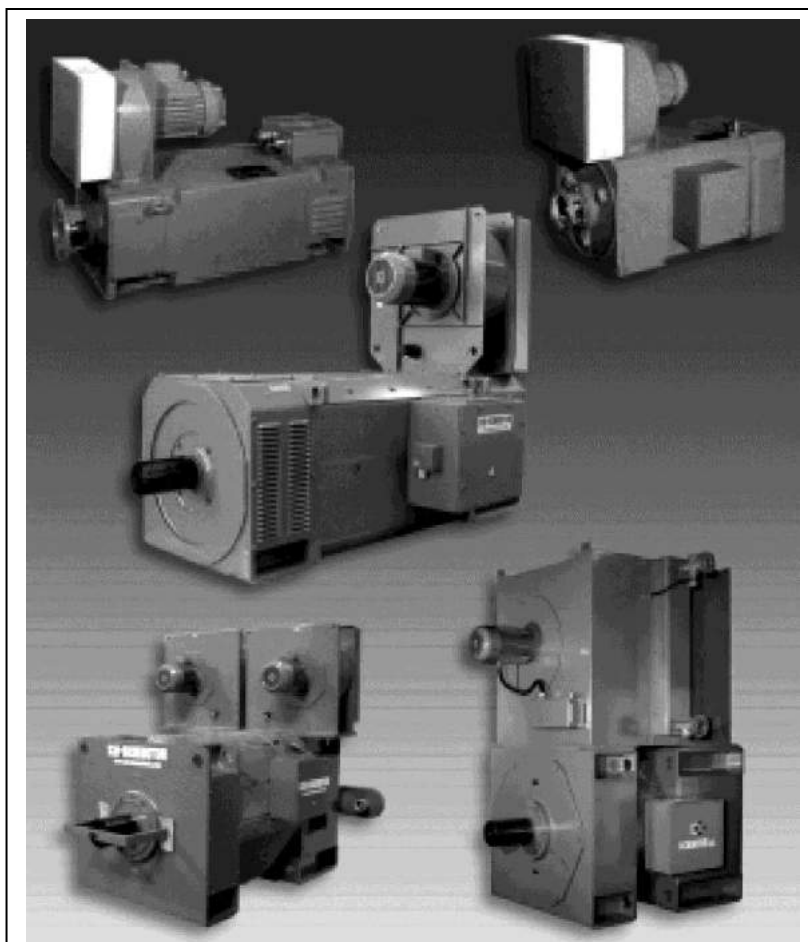

CONTENTS**INTRODUCTION****A. GENERAL DESCRIPTION**

01	Manufacturer's liabilities
02	Validity of the catalogue
03	Reserved property
04	Warranty
05	Introduction to the P-NP series
06	Machines designation
07	Motors and generators
08	Clockwise and counter-clockwise rotation
09	Reference Standards
10	CSA Certification
11	Approvals and certifications
12	Declaration of conformity

B. CONSTRUCTIONAL FEATURES

01	General technical specifications
02	Static and dynamic loads
03	Forms of constructions and mounting arrangements IM
04	Environment
05	Cooling methods IC and degrees of protection IP
06	IC-IP versions derived from the catalogue ones
07	Machines for outdoor installation
08	Tropicalization
09	Stainless steel screws and bolts
10	Assembly position of cooling systems
11	The rotor
11.1	Magnetic circuit
11.2	Commutator
11.3	Windings
12	The stator
12.1	Magnetic circuit
12.2	Windings
13	End shields
14	Brushes and brush-holders
15	Shaft
16	Bearings
17	Pulley coupling - Maximum admissible radial loads – Special bearings for direct coupling
18	Axial load
19	Axial thrusts
20	Balancing and vibrations
21	Noise level
22	Main terminal box
23	Painting of finished products
23.1	Preparation of the surfaces
23.2	Standard painting cycles
24	Main data plate

C. ELECTRICAL CHARACTERISTICS AND PERFORMANCE RATINGS

01	Form factor, ripple and dissymmetry of the armature current
02	Armature current with locked rotor
03	Current gradient
04	Compensating windings
05	Overloads in torque and current
06	NEMA Standards overloads capability
07	Excitation
08	Forcing of the independent field
09	Rotation speed
09.1	Base speed
09.2	Minimum speed

09.3	Maximum speed under field weakening
10	Power
10.1	Nominal power
10.2	Equivalent thermal current
10.3	Equivalent thermal power
11	Different types of duties
11.1	Continuous running duty – Duty type S1
11.2	Short-time duty – Duty type S2
11.3	Intermittent or continuous periodic duties, other duties
11.4	Service Factor
12	Power rating variation with different environmental conditions
13	Power rating variation with different types of cooling
14	Power rating variation with different allowed temperature rise
15	Corrective coefficients
15.1	Corrective coefficients for duties other than S1
15.2	Corrective coefficients for different type of cooling
15.3	Corrective coefficients for temperature rise different than class H
15.4	Corrective coefficient for ambient temperature > 40°C and altitude > 1000 m.a.s.l.
16	Examples of choice of motors

D. COMPANY QUALITY SYSTEM TESTS, CONTROLS, INSPECTIONS

01	Quality control dept.
02	Routine tests
03	Type tests
04	Special tests
05	Witnessed tests

E. ACCESSORIES

01	Accessories for cooling
01.1	Fitted electric fan
01.1.1	Filter
01.1.2	Ventilation failure detector
01.1.3	Spacer for electric fan
01.2	Air-water heat exchanger
01.2.1	Protection devices for air-water heat exchanger
01.2.2	Terminal box for air-water heat exchanger
01.3	Air-air heat exchanger
01.3.1	Protection devices for air-air heat exchanger
01.3.2	Terminal box for air-air heat exchanger
01.4	Natural convection heat exchanger
01.5	Noise reduction devices for machines with fitted electric fan
01.6	Noise reduction devices for machines with fitted heat exchanger
02	Accessories for protection and control
02.1	Devices for protection against overtemperature
02.1.1	Klixon thermal protectors
02.1.2	PTC thermistors
02.2	Overtemperature measuring devices
02.2.1	Pt100 platinum thermal detectors
02.3	Brush wear control device – CR1 system
02.4	Overspeed switch
02.5	Bearing vibration control sensor
02.6	Bearing temperature control sensor
03	Accessories for speed measurement and control
03.1	Tachogenerators



- 03.1.1 Couplings for tachogenerators
- 03.1.2 Provisions for tachogenerators
- 03.1.3 Hollow shaft tachogenerators
- 03.2 Pulse generators
- 03.3 Overspeed switch
- 03.4 Integrated units for speed measurement and control
- 04 Other accessories
- 04.1 Anticondensation heaters
- 04.2 Transparent brushes inspection doors
- 04.3 Rotor earth brushes
- 04.4 Anchorage and foundation devices
- 04.5 Brakes
- 04.6 Belt tensioner slide-rails
- 04.7 Bed-plates

- 04.8 Gearboxes

F. COMMERCIAL INFORMATION

- 01 Offers
- 02 General terms of supply
- 03 Guide-sheet for requests for quotations and orders transmission

G. PERFORMANCE TABLES AND OVERALL DIMENSION DRAWINGS

- 01 Conditions of validity

APPENDIX**1. TORQUE TRANSMISSION**

- 1.a General description
- 1.b Shaft
- 1.c Nominal torque
- 1.d Classification of types of load
- 1.e Normal keyed shaft ends
- 1.f Cylindrical keyless shaft ends
- 1.g Pulley coupling—Maximum admissible radial loads
- 1.h Special bearings for direct coupling

2. INFORMATION ON DUTY CYCLES**3. D.C. MOTORS FOR SOME TYPICAL INDUSTRIAL APPLICATION**

- 3.a Motors for plastic and rubber industries
- 3.b Motors for metal industries
- 3.c Motors for cranes and hoisting equipments
- 3.d Motors for mining industries
- 3.e Motors for skylift and cableways
- 3.f Motors for paper and print industries
- 3.g Motors for food industries
- 3.h Motors for cement factories

4. SOME NOTE ABOUT D.C. MACHINES

- 4.a General features
- 4.b Stator and stator windings structures
- 4.c Rotor structure
- 4.d Brushes
- 4.e General operating principles and main formulas
- 4.f Speed adjustment
- 4.g Some note about D.C. generators

5. SOME USEFUL FORMULAS**6. CONVERSION TABLES****7. LOW VOLTAGE INDUSTRIAL ELECTRICITY SUPPLY IN SOME COUNTRIES**

INTRODUCTION

This catalogue gives a general description of SICMEMOTORI d.c. motors, P-NP series, for industrial applications. All technical details like type of bearings, weights, inertia, type and characteristics of cooling systems, performance tables, drawings, etc. are described in the following technical catalogues:

-	P-NP series frames 80-200	from 2,2 to 975 Nm	code C-NP80-200-E-09
-	NP series frames 225-450	from 1.330 to 15.000 Nm	code C-NP225-450-E-09
-	NP series frames 500-800	from 7.000 to 60.000 Nm	code C-NP500-800-E-08
-	frames 900 and over	up to 190.000 Nm	on request

Please ask your hard copy to SICMEMOTORI sales department or download it from SICMEMOTORI web site www.sicmemotori.com.

Motors with higher torque (up to approx. 190 KNm) are available on request for specific projects; please ask SICMEMOTORI.

A. GENERAL DESCRIPTION

A.01 Manufacturer's liabilities

SICMEMOTORI is subject to assumption of liability for damages to persons or things attributed to the manufacturer by the Italian law DPR 224 dated 24/05/1988 (which has incorporated EEC Directive 85/374) and any subsequent amendments, provided that these are known and in force at the time of order, with the proviso that all SICMEMOTORI products are designed solely for installation and use in an industrial environment by sufficiently experienced personnel (to be instructed by the Customer, with the co-operation of SICMEMOTORI, if required), which is informed of the problems and dangers inherent in the use of rotating electric machines for voltages up to 1000 V.

Furthermore, SICMEMOTORI responsibility shall lapse in the event of failure to adhere to the contents of the INSTRUCTIONS FOR INSTALLATION, USE AND MAINTENANCE, which must always be made available to the personnel concerned. Lastly, SICMEMOTORI shall not be held responsible if any of its products are tampered with for repair or any other reason, by third parties which have not been explicitly authorised

A.02 Validity of the catalogue

Information given in this catalogue is of a purely indicative nature and may be changed without prior notice.

SICMEMOTORI shall not be held responsible if the products illustrated herein are used outside the limits of the specifications given.

A.03 Reserved property

This document and its contents are the sole property of SICMEMOTORI. They may not be reproduced either wholly or in part, nor shown, referred to or in any way transmitted to other persons without express permission in writing from SICMEMOTORI.

A.04 Warranty

All the products described herein are warranted according to our General Terms of Supply given under F.02. The duration of the warranty is one year from the date of delivery or of notice that goods are ready, unless otherwise agreed between the Customer and SICMEMOTORI. **Warranty and sales support are regulated by instructions given by our ISO9001-2000 Quality System.**

A.05 Introduction to the P-NP series

All P-NP D.C. motors have fully laminated frames and class H insulation. The whole series comprises 20 shaft heights (80-90-100-112-132-160-180-200-225-250-280-315-355-400-450-500-560-630-710-800), each one with 3 or more core lengths.

Frames 80-112 are 2 poles, and are only available without compensating windings.

Frames 132-250 are 4 poles, and are available both with and without compensating windings.

Frames 280-450 are 4 poles, and are only available with compensating windings.

Frames 500-710 are 6 poles, and are only available with compensating windings.

Frame 800 is 8 poles, and is only available with compensating windings

The power and speed ranges of the versions with and without compensating windings are generally similar for any given size and armature voltage, but compensation enhance performances under conditions of overloads or weakened field flux. A broad set of standardised windings are available for each size in both versions, which offers a considerable number of winding voltage-speed combinations. The magnetic circuit and windings have been designed with special design criteria to obtain excellent commutation features.

In addition to meeting or exceeding the specifications of Industry Standards, both the materials and application technologies used for insulating and impregnating the windings, together with the materials and the manufacturing criteria of the commutators, warrant top-rate general behaviour under even the toughest conditions of use.

A.06 Machines designation

The machine designation takes account of the shaft height, the core length and also of the particular 'manufacture' (corresponding to an "IP" degree of protection and an "IC" type of cooling) and of the constructive form "IM". An example of identification code is given below.

NP	Designation of series (P-NP)
250	Shaft height
K	Letter indicating compensated machine (N: not compensated machine)
L	Length category (core length)
5	Selection code for length definition (1)
CBARH	Cooling method code (2)
B3	Form of construction code (3)

Notes: (1) Selection code for length definition
This depends on the number of brushes, thus on the length of the commutator. It distinguishes the dimensions corresponding to the machine on the overall dimensions drawing (see on Technical catalogues)

(2) Cooling method code
This is defined by a SICMEMOTORI code. See B.05. The data plate states the IC cooling method (according to IEC Std. 34-6) and IP degree of protection (according to IEC Std. 60034-5).

(3) Form of construction code
This is abbreviated using the codes of CEI Std. 2-14 (refer to B.03). The data plate states the form of construction and assembly layout IM according to IEC Std. 60034-7

A.07 Motors and generators

All P-NP machines can in general be used both as motors and as d.c. generators. Performance ratings given in the technical catalogues refer to use as variable speed motors connected to three-phase, fully-controlled bridge (6 or 12 thyristors) or, for frames 80-112 only, to single-phase bridge also.

The performance ratings concerning use as generator will be given upon request.

A.08 Clockwise and counter-clockwise rotation

All P-NP machines are suitable for either clockwise or counter-clockwise rotation without adjustment (as the brushes are radial), and they are generally tuned in the Test Room for this operating condition. In special cases, when the direction of rotation is defined, upon request, Test Room tuning may be carried out for one direction only, which will be indicated by a special plate on the DE (Drive End) shield.

A.09 Reference Standards

All P-NP machines meet the Standards of the International Electrotechnical Commission (IEC 60034-1):

IEC	CEI	Title
60034-1	EN 60034-1	Rating and performances
60034-2	EN 60034-2	Methods for determining losses and efficiency
60034-5	EN 60034-5	Classification of the degrees of protection
60034-6	EN 60034-6	Methods of cooling (IC code)
60034-7	EN 60034-7	Type of construction and mounting arrangements (IM code)
60034-8	EN 60034-8	Terminal markings and direction of rotation
34-9	EN 60034-9	Noise limits
60034-14	EN 60034-14	Mechanical vibrations of rotating machines
72-1	72-1	Dimensions and output series for rotating machines
1293	16-8	Markings of electrical devices
UNI ISO 2768/1-2		General tolerances
UNI 9321		Shaft end
73/23/EEC		Low voltage directive
89/336/EEC (EMC)		Electromagnetic compatibility directive
98/37/CE		Machine directive

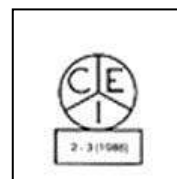

WARNING

Motors and electrical devices feeding them are electrical components installed on machines and industrial systems subject to high voltage. During operation, these components can be dangerous since they are live and have non-insulated and rotating parts. Therefore, they can be extremely harmful to personnel and objects if the instructions for the installation, the use and the maintenance are not respected.

Motors are always supplied complete with the installation, use and maintenance instruction manual. It is necessary to read and understand all the information contained before proceeding to connect and to start up the installation.

If the above mentioned documentation is lacking, please request a copy to Sicme Motori SpA.

P-NP motors power ratings are valid according to the International Standards listed below.

Belgium	BN C 51-101
France	NF C 51-111
Germany	VDE 0530 teil 1
Great Britain	BS 4999
ITALY	CEI EN 60034-1
Norway	NEN 41.69
Holland	NEN 3173
Spain	UNE 20.106-20.111
Sweden	SEN 260.101
Switzerland	SEV 3009

Machines according to other International Standards are available on request.

A.10 CSA Certification

All P-NP machines have been approved and certified as meeting the Standards of the Canadian Standards Association, and they are therefore allowed to bear the CSA brand. The certification number is LR77401.

**A.11 Approvals and Certifications**

All P-NP machines may be built and certified according to RINA, BUREAU VERITAS, DET NORSKE VERITAS, GERMANISCHER LLOYD, LLOYD'S REGISTER OF SHIPPING, AMERICAN BUREAU OF SHIPPING, CENELEC EN 50014-50016 Standards for EEXp pressurised flameproof machines, etc.

A.12 Declaration of conformity

All P-NP machines satisfy the essential requisites of the following Directives:

- 2006/95/CE Low Voltage Directive



Reference has also been made to the following directives, specifically for the reasons listed as follows:

- EMC 2004/108/CE (Electromagnetic Compatibility) Directive
- 2006/42/CE Machinery Directive

The electric motors/generators are components that are incorporated into other machines, systems and plants and therefore the resulting EMC behaviour is under the responsibility of the Manufacturer of the machine or plant incorporating the motor/generator.

With reference to the 2006/42/EC Directive, it must be specified that the motors/generators must be installed in compliance with the installation instructions and cannot be put into service until the machine in which they are incorporated has been declared in compliance with the 2006/42/EC Machinery Directive

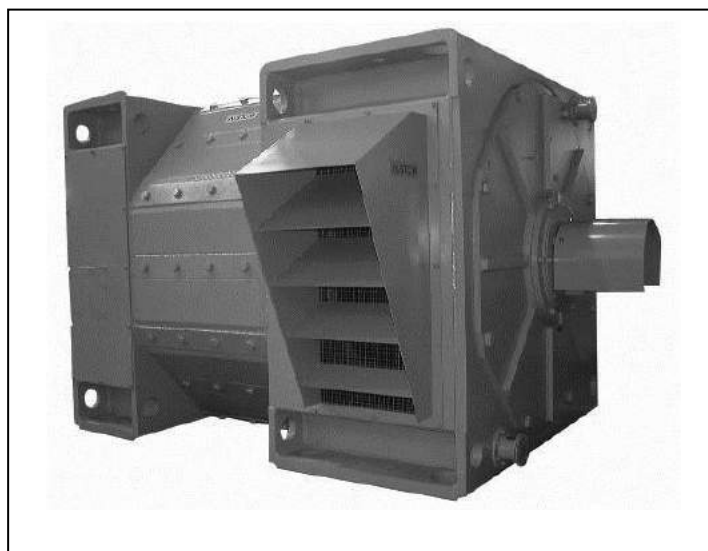

B. CONSTRUCTIONAL FEATURES

B.01 General technical specifications

Mechanical and electrical data of general interest relating to the P-NP machines are showed on technical catalogues.

B.02 Static and dynamic loads

Static and dynamic loads are necessary to calculate and size the foundations (see F.4.3.3) and related anchorage.

Table b.02 gives the figures in N of the dynamic loads; static load, on each zone B, is equal to the half of the motor weight (for motor weight please refer to technical catalogues).

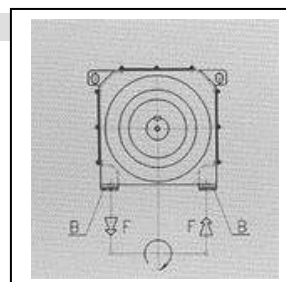

Motor frame	Max. short circuit (*) Dynamic load (N)	Motor frame	Max. short circuit (*) dynamic load (N)	Motor frame	Max. short circuit (*) dynamic load (N)
NP 80 NS	± 880	NP280KS	± 66.300	NP560KRS	± 102.000
NP 80 NM	± 1.200	NP280KM	± 73.300	NP560KRM	± 118.000
NP 80 NL	± 1.450	NP280KL	± 83.100	NP560KR	± 129.000
NP 90 NR	± 1.570	NP315KS	± 79.700	NP560KS	± 145.000
NP 90 NS	± 2.000	NP315KM	± 89.700	NP560KSM	± 163.000
NP 90 NM	± 2.620	NP315KL	± 101.900	NP560KM	± 181.500
NP 90 NL	± 3.070	NP355KR	± 74.000	NP560KML	± 206.000
NP100NR	± 2.560	NP355KS	± 95.000	NP560KL	± 231.000
NP100NS	± 3.250	NP355KM	± 105.900	NP560KX	± 253.000
NP100NM	± 3.940	NP355KL	± 119.600	NP630KRS	± 116.500
NP100NL	± 4.250	NP355KX	± 135.000	NP630KRM	± 130.000
P 112 NS	± 2.900	NP400KR	± 85.000	NP630KR	± 146.000
P 112 NM	± 3.700	NP400KS	± 110.700	NP630KS	± 161.000
P 112 NL	± 4.480	NP400KM	± 122.400	NP630KSM	± 177.000
P 132 N(K)S	± 4.400	NP400KL	± 137.000	NP630KM	± 196.000
P 132 N(K)M	± 5.550	NP400KX	± 153.900	NP630KML	± 217.000
P 132 N(K)L	± 6.950	NP450KRS	± 75.000	NP630KL	± 245.000
P 132 N(K)X	± 7.870	NP450KRM	± 88.400	NP630KX	± 278.000
P 160 N(K)S	± 8.250	NP450KR	± 94.800	NP710KRS	± 121.000
P 160 N(K)M	± 10.730	NP450KS	± 106.300	NP710KRM	± 137.000
P 160 N(K)L	± 13.200	NP450KSM	± 118.300	NP710KR	± 153.000
P 160 N(K)X	± 14.950	NP450KM	± 133.200	NP710KS	± 170.000
P 180 N(K)S	± 12.900	NP450KML	± 148.800	NP710KSM	± 189.000
P 180 N(K)M	± 16.500	NP450KL	± 167.500	NP710KM	± 208.000
P 180 N(K)L	± 20.800	NP450KX	± 188.700	NP710KML	± 236.000
P 180 N(K)X	± 22.950	NP500KRS	± 85.500	NP710KL	± 261.000
P 200 N(K)S	± 16.700	NP500KRM	± 98.000	NP710KX	± 296.000
P 200 N(K)M	± 21.400	NP500KR	± 107.000	NP800KRS	± 173.000
P 200 N(K)L	± 28.000	NP500KS	± 120.000	NP800KRM	± 195.000
P 200 N(K)X	± 31.500	NP500KSM	± 131.000	NP800KR	± 220.000
NP225N(K)S	± 37.600	NP500KM	± 153.000	NP800KS	± 244.000
NP225N(K)M	± 42.100	NP500KML	± 167.000	NP800KSM	± 274.000
NP225N(K)L	± 47.100	NP500KL	± 191.000	NP800KM	± 306.000
NP250N(K)S	± 49.200	NP500KX	± 218.000	NP800KML	± 342.000
NP250N(K)M	± 54.900			NP800KL	± 385.000
NP250N(K)L	± 60.300			NP800KX	± 432.000





(*) on each B area. The compression (+) or traction (-) load force is connected with the torque reaction and depends on the direction of rotation.
Table b.02

B.03 Forms of constructions and mounting arrangements IM

Most of form of construction and mounting IM described in IEC Standards 60034-7 are available; table b.03 shows the most common ones.

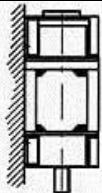
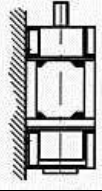
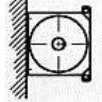
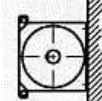
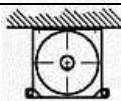
For other forms of construction please ask SICMEMOTORI.

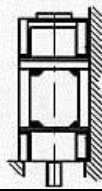
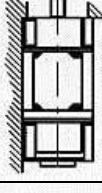
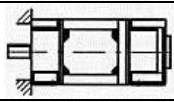
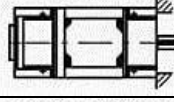
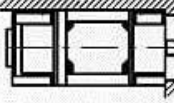
Second shaft end is also available on request (in this case the last number is 2: example IM1002).

IM	Description		80 112	132 160	180 200	225 250	280 315	355 450	500 800
1001 (B3) (1)	Horizontal shaft, foot mounting. Ground fastening		S	S	S	S	S	S	S
1011 (V5) (1)	Vertical shaft, with foot. Wall fastening. Shaft below		S	S	S	S	S	O	O
1031 (V6) (1)	Vertical shaft, with foot. Wall fastening. Shaft above		S	S	S	S	S	O	O
1051 (B6) (1)	Horizontal shaft, foot mounting. Wall fastening at the left		S	S	S	S	S	S	O
1061 (B7) (1)	Horizontal shaft, foot mounting. Wall fastening at the right		S	S	S	S	S	S	O
1071 (B8) (1)	Horizontal shaft, foot mounting. Ceiling fastening		S	S	S	S	S	S	O
2001 (B35) (2)	Horizontal shaft, foot and flange with through holes. Feet fastened to ground		S	S	S	S	S	S	O
2011 (V15) (2)	Vertical shaft, foot and flange with through holes. Feet fastened to wall. Shaft below		S	S	S	S	S	O	O
2031 (V36) (2)	Vertical shaft, foot and flange with through holes. Feet fastened to wall. Shaft above		S	S	S	S	S	O	O
2051 (B65) (2)	Horizontal shaft, foot and flange with through holes. Feet fastened to wall at the left		S	S	S	S	S	S	O
2061 (B75) (2)	Horizontal shaft, foot and flange with through holes. Feet fastened to wall at the right		S	S	S	S	S	S	O
2071 (B85) (2)	Horizontal shaft, foot and flange with through holes. Feet fastened to ceiling		S	S	S	S	S	S	O
2101 (B34) (2)	Horizontal shaft, foot and flange with threaded holes. Feet fastened to ground		S	S	S	S	S	O	O

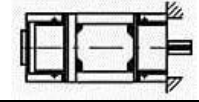
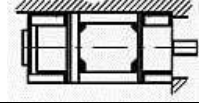
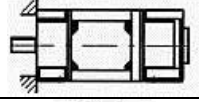
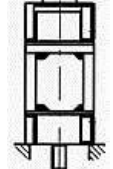
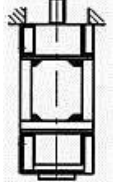
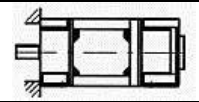
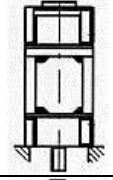
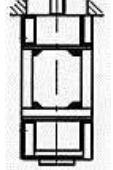
IM	Description		80 112	132 160	180 200	225 250	280 315	355 450	500 800
2151 (B64) (2)	Horizontal shaft, foot and flange with threaded holes. Feet fastened to wall at the left		S	S	S	S	S	O	O
2161 (B74) (2)	Horizontal shaft, foot and flange with threaded holes. Feet fastened to wall at the right		S	S	S	S	S	O	O
2171 (B84) (2)	Horizontal shaft, foot and flange with threaded holes. Feet fastened to the ceiling		S	S	S	S	S	O	O
3001 (B5) (3)	Horizontal shaft with flange with through holes		S	S*	O	O	O	O	O
3011 (V1) (3)	Vertical shaft with flange with through holes. Shaft below		S	S*	O	O	O	O	O
3031 (V3) (3)	Vertical shaft with flange with through holes. Shaft above		S	S	S	O	O	O	O
3601 (B14) (3)	Horizontal shaft with flange with threaded holes		S	S*	O	O	O	O	O
3611 (V18) (3)	Vertical shaft with flange with threaded holes. Shaft below		S	S*	S	O	O	O	O
3631 (V19) (3)	Vertical shaft with flange with threaded holes. Shaft above		S	S	S	O	O	O	O

- (1): Motors with feet Table b.03
 (2): Motors with feet and flange (please refer to par. E.04.8)
 (3): Motors with flange (please refer to par. E.04.8)
 S: Standard
 *: Available on request for P160X
 O: Option available on request

B.04 Environment

For standardisation it is assumed that the environment in which our machines are installed is benign, thus:

- dry**, i.e. with relative humidity of the air below 75%. However an excessively dry atmosphere (below 20% relative humidity) can cause commutating difficulty (excessive brush wear).
- clean**, i.e. without appreciable quantities of dust and dirt in general, suspended in the air.
- free of chemical agents**, i.e. without concentrations of gas or vapours that could chemically harm the copper, iron, aluminium, paints and insulation.

Our machines can also be installed in difficult environments (damp, dusty, chemically harmful, etc) but in this case the degree of protection, method of cooling and possibly the choice of materials must be agreed upon previously.
 All P-NP machines may be installed in environments with temperature down to -15°C and stored in environments with temperature down to -30°C. For lower temperatures please ask SICMEMOTORI.

B.05 Cooling methods IC and degrees of protection IP

P-NP motors can be supplied with various IC cooling methods (according to IEC Std. 34-6), with the corresponding IP degrees of protection (according to IEC Std. 60034-5). The different versions are distinguished by a special SICMEMOTORI code, to which reference should be made also for calculating the price, bearing in mind that as far as the price is concerned:

- BPVA and BPVAB are the same as PVA
- BCA is the same as CBA

In addition to the catalogue versions, illustrated in table b.05, other versions (with different cooling methods and/or degree of protection) are available upon request.



IP	IC	Description		SICME MOTORI code
23	06	Forced ventilation by fitted fan. Suction exhaust to the local atmosphere		PVA
	16	Forced ventilation by fitted fan, with ducted air inlet and outlet vent to local atmosphere		BPVA
	17	Ventilation by external system with ducted air inlet and outlet vent to local atmosphere		BCA
44 54 55	410	Totally enclosed not ventilated machine		CNV
	610	Totally enclosed machine with air to air heat exchanger in self ventilated version for air circulating inside with external air cooling by natural convection (for frames 132-250 only)		CNVC
	36	Force ventilation by integral system with air inlet and outlet ducts		BPVAB
	37	Ventilation by external system with air inlet and outlet ducts		CBA
	86W	Assisted ventilation in closed cycle with air-water heat exchanger (for frames 132-800 only)		CBARH
	666	Assisted ventilation in closed cycle with air-air heat exchanger (for frames 132-560 only)		CBARO

Table b.05

Notes: Machines with IP54 and IP55 degree of protection are suitable for outdoor installation only if under a shed or special cover

B.06 IC-IP versions derived from the catalogue ones

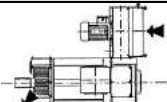
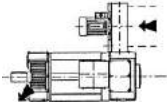
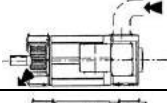
These are special versions designed to obtain a degree of protection above IP 44 for the closed machines, as follows:

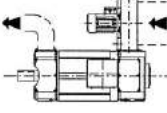
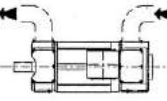
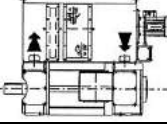
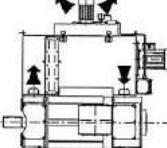
- IP54 or IP55: addition of an "Angus" ring for axial shaft sealing, at the drive end, and other special features;
- IP23W - IP55W; these versions are developed on request (refer to par. B.07).

B.07 Machines for outdoor installation

The designation of the degree of protection according to IEC 60034.5 is with letter W. There are 2 cases:

Open machines (protection IP 23 W), in the sense that air from the outside environment circulates in contact with the active parts for cooling. Suitable devices are provided to separate any drops of water and solids (dust) carried in the air before it enters the machine. Terminal boxes degrees of protection is IP 54 or higher. Please ask SICMEMOTORI.

Closed machines (protection IP 55 W or higher), with type of cooling from IC 410 to IC 666 of table b.05. The machine should be chosen with protection degree IP 55, with the addition of devices to trap wind-blown dust and dirt outside the frame as well as ensuring that the machine is weather resistant. Ask SICMEMOTORI.

In both of the above-mentioned cases, if the environment temperature can fall below 0°C, precautions must be taken against the formation of ice in the cooling ducts and on the fan impellers.

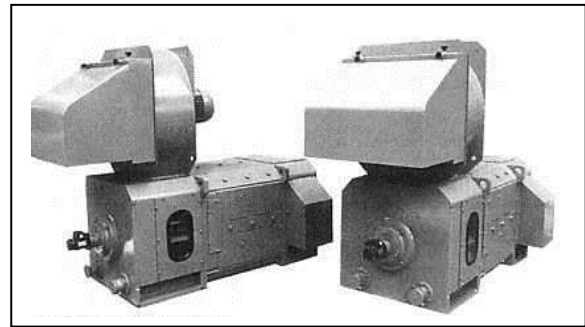

B.08 Tropicalization

Tropicalization treatment of the windings consists of impregnating and coating the windings with varnish incorporating additives to resist moulds.

For frames 225-800 is standard.

For frames 80-200 is available on request.

B.09 Stainless steel screws and bolts

For installation in environments with a chemically aggressive or salty atmosphere, the use of stainless steel bolts and screws is essential:

closed machines (IP44 or higher)

The use of stainless steel bolts and screws is limited to the outside ones: inspection doors, terminal box covers, fastening screws, grease guards and heat exchangers, etc..

protected machines (IP23)

Inspection doors or guard fastening screws, covers and terminal box screws fastening the fan, guards, grease guards and brush holder are made from stainless steel.

B.10 Assembly position of cooling systems

On general principle, the cooling equipment (fan with filter, heat exchanger) can be fitted either at the top or on one side of the machine.

However, practical problems can arise if the terminal box is required in the same position as the cooling equipment (also see F.1.0.3).

A guide to the possible choices in the case of cooling with integral fan is given in tables b.10.1 and b.10.2

In the case of heat exchangers, please ask SICMEMOTORI.

Terminal box	Fan		
	Top	Right	Left
Right	NO	NO	NO
Left	NO	NO	NO
Top	Standard	YES	YES

Table b.10.1 – frames 80-112

Terminal box	Fan		
	Top	Right	Left
Right	Standard	NO	YES
Left	YES	YES	NO
Top	NO	YES	YES

Table b.10.2 – frames 132-800

YES : possible

NO : possible on request, when ordering

B.11 The rotor

B.11.1 Magnetic circuit

This is formed of low loss disk laminations painted on both sides. The pack of laminations is induction-heated before inserting the shaft (keyless) and is thus fitted on the shaft itself with an interference which ensures torque transmission even in the event of sudden inversions or short circuit.

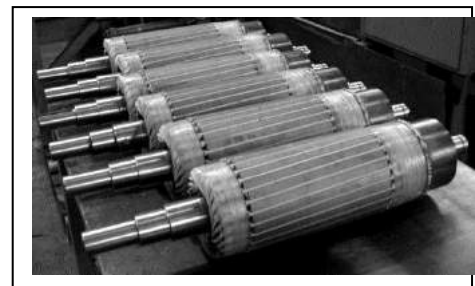

B.11.2 Commutator

Commutator segments are made from electrolytic copper. Insulation between segments is in micanite with synthetic class H binder. Commutator assembling on the shaft is with interference, keyless.

Frames 80-200

Commutator is moulded in resin; for some specific application a V-ring commutator design can be used. Winding wires are soldered to the commutator lugs with a special tin alloy, with softening temperature above the maximum temperature attainable in service. When necessary by the application, TIG welding system can be used.

Frames 225-315

Commutator is moulded in resin; for some specific application a V-ring commutator design can be used. Connections between winding wires to commutator lugs is made by TIG welding system.

Frames 355-800

Commutator is banded. Connections between winding wires to commutator lugs is made by TIG welding system.

B.11.3 Windings

Windings are made from class H enamelled copper strip, with additional thickness of reinforced insulation, or with class H enamelled copper wire, with grade 2 double thickness. For frames 355-800 an extra reinforcing is obtained by incorporating a layer of woven glass fibre insulation.

The materials used for insulation from earth are all class H (insulating layers and insulation of slots in nomex). Length cutting, terminal stripping and forming of the conductors are performed by special systems and equipment.

Impregnation is carried out with single-component polyester resin without solvent and it is total, VPI type, pressurized under vacuum; this way the best possible heat transmission between the wires and the magnetic pack is obtained; the banding of the winding heads is carried out hot with glass tape impregnated with polymerised heat hardening polyester resin.

For frames 225-800 windings surfaces are protected by a coat of protecting varnish.

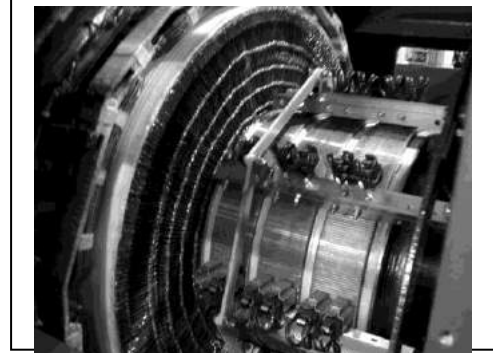
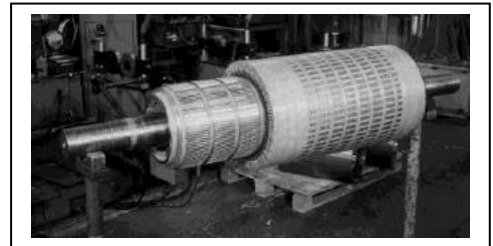
**B.12 The stator****B.12.1 Magnetic circuit**

Machines described in this catalogue have a polygonal cross-section, with:

- 2 main poles and 2 commutating poles for frames 80-112;
- 4 main poles and 4 commutating poles for frames 132-450;
- 6 main poles and 6 commutating poles for frames 500-710;
- 8 main poles and 8 commutating poles for frame 800

The magnetic circuit (frame and poles) is fully laminated. This enables good commutation even in the event of sudden current peaks due to thyristors supply. The particular construction of the stator pack enables the reduction of eddy currents and helps to make the machine capable of withstanding very high current gradients (see D.02.5). The plates are pressed inside a sturdy steel cage, welded by a fully automatic system; the result is a compact and rigid block.

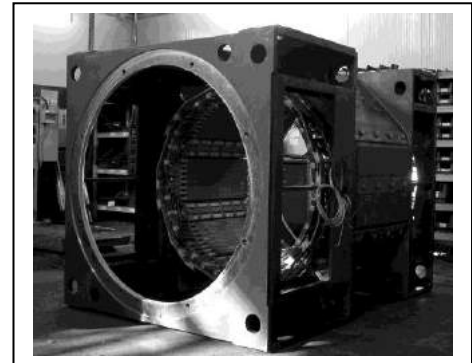
**B.12.2 Windings**

Windings on the main and commutating poles are in class H enamelled copper wire or strip with the same features described for the rotor windings (see B.10.3). Impregnation and surface protection processes are also similar.

B.13 End shields

The utmost care is given to manufacture the end shields (DE and NDE) in very high precision CNC machines. End shields are manufactured with wide openings to provide good access to the commutator (and to the brushes and brush-holders) and simplify version changes (moving the fan for example) necessary at times when the machine has already been delivered.

The shields used for the machines in this catalogue are made by:

- aluminium for frames 80-112;
- cast iron for frames 132-280;
- electrically-welded steel for frames 315-800

When requested by the type of application, also end shields of frames 132-280 can be made in electrical-welded steel.

For motors with mounting arrangements IM2001-IM3001 and derivated to be connected directly to a gearbox, please refer to par. E.04.8.

B.14 Brushes and brush-holders

Brush holders used are of the constant pressure type: the pressure exerted on the brush is practically constant, it is not affected by gradual brush wear and does not require adjustment over the course of time.

Various types of brushes are available with different physical characteristics and compositions; they can be of the twin type when requested by the duty. Motors frames 225-800 have always twin brushes.

Test Room checks the suitability of the type of brush specified by the Technical Dept., bearing in mind the actual conditions of use as far as possible.

If working experience suggests the need to change the type of original brush, it is recommended that as a precaution SICMEMOTORI should always be consulted beforehand for approval.

Brush holders are available with brush wear monitor device (see E.02.3).

After final machine set-up (brushes in neutral zone) in the Test Room, the position of the brush rocker plate is locked and marked, to simplify refitting after removal during maintenance.

B.15 Shaft

The shaft is normally in carbon steel with bearings housings accurately machined; the rotor pack is hot fitted on the shaft with interference (see B.11.1). For very high loads, special steels are used.

The torque is normally transmitted to the coupled load by one shaft end, but upon request a second shaft end can be specified (of course the total power transmitted should not exceed the machine data plate power).

The second shaft end on the commutator side is sized for the nominal torque rating and can only be used with direct coupling.

The shaft end is normally keywayed, but keyless shaft are available on request or when the particular application makes it necessary (for applications with fast and frequent overloads, or for tandem or triple motors, keyless shaft is strongly recommended). In that case, shrunk-on of half couplings on shafts must be made at hot, with interference.

Please refer to Appendix, paragraphs 1a-1f, to calculate the maximum transmissible torque in function of the load.

B.16 Bearings

Bearings normally specified for the machines in this catalogue are rolling bearings, ball or roller. All bearings are oversized clearance C3.

DE ball bearings are available for direct coupling without radial load (please refer to par. B.17).

Frames 80-180

Standard arrangement uses ball bearings on both DE and NDE, life lubricated, double shield (2Z type).

DE roller bearings are available for coupling with pulley and belt with high radial load. (except for frames 80-100; please refer to par. B.17)

Frame 200

Standard arrangement uses ball bearings on both DE and NDE, grease lubricated, with ball nipple and drainage of used grease, single shield (Z type).

DE roller bearings are available for coupling with pulley and belt with high radial load (please refer to par. B.17).

Frames 225-800

Standard arrangement uses ball bearing on NDE and roller bearing on DE, grease lubricated, with ball nipple and drainage of used grease

The recommended lubrication intervals and the amount of grease to be used are given on the data plate. To define the lubrication programme, complete grease changing and changing the bearings, strict compliance with the Instructions for Installation, Use and Maintenance is necessary.

Bearings allow a radial and/or axial load in relation to the speed of rotation, type of load and theoretical life calculated on the basis of statistic data made available by the bearing manufacturers. In case of radial and/or axial loads, please ask SICMEMOTORI.

Bearings normally used are shown in the Technical Catalogues. Anyway, table b.16 shows the standard ones.

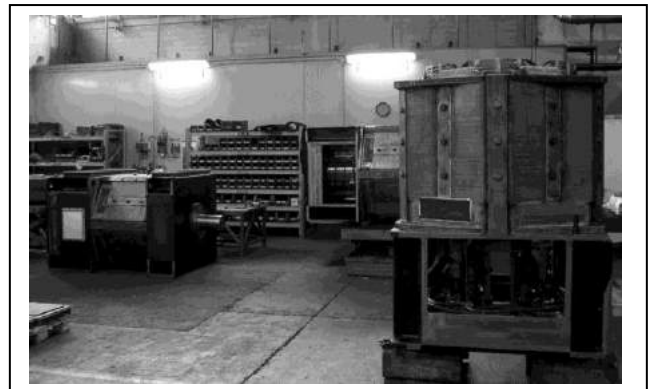
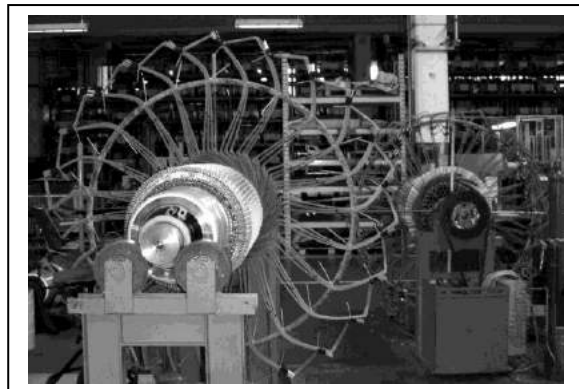
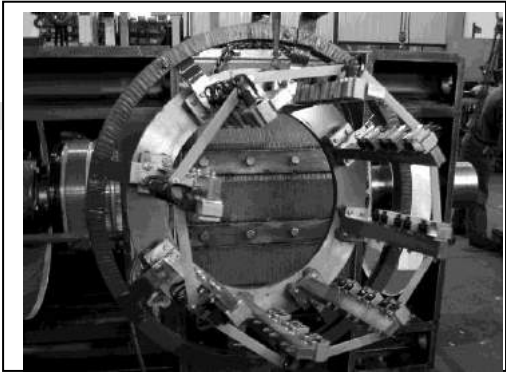
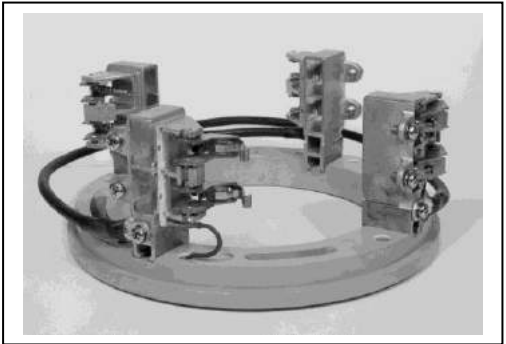

Motor size	DE bearing			NDE bearing		
	Type	SICMEMOTORI code		Type	SICMEMOTORI code	
NP 80	Ball	6305-2Z-C3	8.3.09.19.025.0	Ball	6204-2Z-C3	8.3.09.10.020.0
NP 90	Ball	6306-2Z-C3	8.3.09.19.030.0	Ball	6305-2Z-C3	8.3.09.19.025.0
NP100	Ball	6308-2Z-C3	8.3.09.19.040.0	Ball	6306-2Z-C3	8.3.09.19.030.0
P 112	Ball	6308-2Z-C3	8.3.09.19.040.0	Ball	6306-2Z-C3	8.3.09.19.030.0
P 132	Ball	6310-2Z-C3	8.3.09.19.050.0	Ball	6308-2Z-C3	8.3.09.19.040.0
P 160	Ball	6312-2Z-C3	8.3.09.19.060.0	Ball	6309-2Z-C3	8.3.09.19.045.0
P 180	Ball	6312-2Z-C3	8.3.09.19.060.0	Ball	6310-2Z-C3	8.3.09.19.050.0
P 200	Ball	6314-Z-C3	8.3.09.18.070.0	Ball	6314-Z-C3	8.3.09.18.070.0
NP225	Roller	NU2218-C3	8.3.09.75.090.0	Ball	6315-C3	8.3.09.17.075.0
NP250	Roller	NU2220-C3	8.3.09.75.100.0	Ball	6318-C3	8.3.09.17.090.0
NP280	Roller	NU2220-C3	8.3.09.75.100.0	Ball	6318-C3	8.3.09.17.090.0
NP315	Roller	NU321-C3	8.3.09.63.105.0	Ball	6321-C3	8.3.09.17.105.0
NP355	Roller	NU324-C3	8.3.09.63.120.0	Ball	6324-C3	8.3.09.17.120.0
NP400	Roller	NU228-C3	8.3.09.74.140.0	Ball	6228-C3	8.3.09.09.140.0
NP450KRS-KS	Roller	NU320-C3	8.3.09.74.150.0	Ball	6230-C3	8.3.09.09.150.0
NP450KSM-KX	Roller	NU232-C3	8.3.09.74.160.0	Ball	6232-C3	8.3.09.09.160.0
NP500KRS-KS	Roller	NU234-C3	8.3.09.74.170.0	Ball	6234-C3	8.3.09.09.170.0
NP500KSM-KX	Roller	NU236-C3	8.3.09.74.180.0	Ball	6236-C3	8.3.09.09.180.0
NP560KRS-KS	Roller	NU236-C3	8.3.09.74.180.0	Ball	6236-C3	8.3.09.09.180.0
NP560KSM-KX	Roller	NU238-C3	8.3.09.74.190.0	Ball	6238-C3	8.3.09.09.190.0
NP630KRS-KS	Roller	NU238-C3	8.3.09.74.190.0	Ball	6238-C3	8.3.09.09.190.0
NP630KSM-KX	Roller	NU244-C3	8.3.09.72.220.0	Ball	6244-C3	8.3.09.09.220.0
NP710KRS-KR	Roller + ball	NU244-C3 + 6044-C3	8.3.09.74.220.0 + 8.3.09.05.220.0	Roller	NU244-C3	8.3.09.74.220.0
NP710KS-KM	Roller + ball	NU248-C3 + 6048-C3	8.3.09.74.240.0 + 8.3.09.05.240.0	Roller	NU248-C3	8.3.09.74.240.0
NP710KML-KX	Roller + ball	NU252-C3 + 6052-C3	8.3.09.74.260.0 + 8.3.09.05.260.0	Roller	NU252-C3	8.3.09.74.260.0
NP800KRS-KR	Roller + ball	NU248-C3 + 6048-C3	8.3.09.74.240.0 + 8.3.09.05.240.0	Roller	NU248-C3	8.3.09.74.240.0
NP800KS-KM	Roller + ball	NU252-C3 + 6052-C3	8.3.09.74.260.0 + 8.3.09.05.260.0	Roller	NU252-C3	8.3.09.74.260.0
NP800KML-KX	Roller + ball	NU256-C3 + 6056-C3	8.3.09.74.280.0 + 8.3.09.05.280.0	Roller	NU256-C3	8.3.09.74.280.0

Table b.16

B.17 Pulley coupling – Maximum admissible radial loads – Special bearings for direct coupling

When the torque transmission is made through a pulley-belt system, it is necessary to verify the radial load F_r applied to the shaft end and to the DE bearing, to avoid to incur in serious problems on the shaft end and DE bearing themselves.

The radial load F_r is generated by the "belt pull", necessary for the correct torque transmission, every time there is such a type of coupling between motor and load.

Please refer to Appendix, paragraph 1g, to calculate the type of bearing to use.

B.18 Axial load

The axial load may be induced by the coupled machine, or caused by the type of coupling adopted. The Customer should always inform SICMEMOTORI of the amount and direction of any axial load.

In general, machines built for operation with vertical axis accept a coupling element with steady axial load of $\pm 10\%$ of the rotor weight with no need of constructional alterations.

B.19 Axial thrusts

These thrusts (instantaneous stresses, possibly repeated) can lead from the coupled machine. Please always ask SICMEMOTORI in cases like these.

B.20 Balancing and vibrations

All the machines in this catalogue are balanced according to IEC 60034-14 Class N. Balancing is carried out with the half key (therefore the half-coupling must be balanced with half key). Machines with special balancing (class R or S) are supplied upon request.

Limits of vibration severity are given in table b.20 (tolerance $\pm 10\%$).

Class	Speed (rpm)	Limits of vibration severity in mm/sec			
		80-132	160-225	250-400	450-800
N	600-3600	1,8	2,8	3,5	3,5
R	600-1800	0,71	1,12	1,8	2,8
	1801-3600	1,12	1,8	2,8	2,8
S	600-1800	0,45	0,71	1,12	---
	1801-3600	0,71	1,12	1,8	---

Table b.20

Test must be carry out with the method of free suspension or with motors placed on rubber ?????
Grade S is not applicable to motors frames >400.

B.20.1 Cooler AC motor vibrations (coolings IC06 and derived, IC86W, IC666)

Test is carried out using a vibrometer and checking that vibrations values measured at points A,B,C,D, whit ac motor supplied with nominal voltage and frequency, are within values given in table b.20.1.

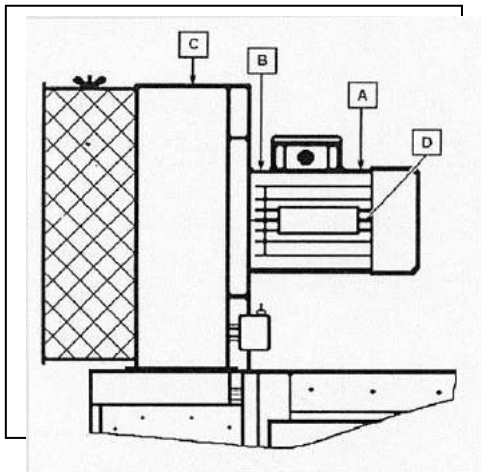

D.C. motor frame	Max measured value (mm/sec)
≤ 160	4,5
180-200	7,1
≥ 225	10

Table b.20.1

A-B-D : points of measure on AC motor
C : point of measure on the blower scroll (IC06 and derived motors) or on the fixing blower flange (IC86W and IC666 motors)

B.21 Noise level

According to IEC 34-9, noise levels to be warranted refer to a machine operating with no load, powered at the nominal supply voltage, with the ventilation system on.

Noise levels expressed in 'sound pressure' are detected using a phonometer positioned at the centre of the 4 sides of the direct current machine tested and of the nosepiece of the fan for PVA motors, or of the asynchronous motor for machines with heat exchangers, at a distance of approx.1 metre.

The mean of these values is the noise rating adopted by SICMEMOTORI.

Typical values of the sound pressure and of the associated power, obtained by the methods described above, valid for motors with combined fan with 50 Hz filter are given in table b.21.

Motor	Sound pressure (dBA) Cooling IC06 (PVA)	Sound pressure (dBA) Cooling IC86W (CBARH)	Sound pressure (dBA) Cooling IC666 (CBARO)
80 N	76	---	---
90 N	76	---	---
100 N	76	---	---
112 N	80	---	---
132 N	80	80	86
132 K	80	80	86
160 N	80	80	86
160 K	80	80	86
180 N	82	80	86
180 K	82	80	86
200 N	85	80	86
200 K	85	82	86
225 N	85	82	86
225 K	85	82	86
250 N	85	82	86
250 K	85	82	86
280 K	85	82	86
315 K	85	82	86
355 K	85	82	90
400 K	85	82	90
450 K	85	82	90
500 K	85	84	90
560 K	85	84	90
630 K	90	84	90
710 K	90	85	95
800 K	90	90	95

Table b.21

B.22 Main terminal box

The main terminal box is in welded steel (excepted for frames 80-112, where it is in aluminium), and very generously sized inside, in compliance with CSA and NEMA Standards.

It contains:

- the main terminals (armature circuits), formed of generously-sized copper bars, fastened in insulated supports, pierced to simplify the fitting of the plant cables.
- a terminal block for the separately excited field circuit
- a terminal block for the auxiliary protection circuits
- a box earth terminal distinguished by a special data plate.

The standard terminal box has IP54 degree of protection. Higher degrees of protection can be obtained upon request. Terminal box is normally located at right (viewing from the DE); on request, when ordering, it can be positioned on top or left side (see B.10); frames 80-112 have terminal box on top as standard.

The diagrams for connection to the terminal box for motors with separate excitation and compensation windings are shown in fig.b.22.1 and b.22.2 (terminals marked according to IEC 60034-8).

On the standard version, two plates, 4 mm or more in thickness are screwed on opposite walls of the box, to be drilled by the Customer.

The terminal box is rectangular, with the longer side normally at right angles to the machine axis. The box can be fitted turned 90° on its own axis, if this is requested when ordering.

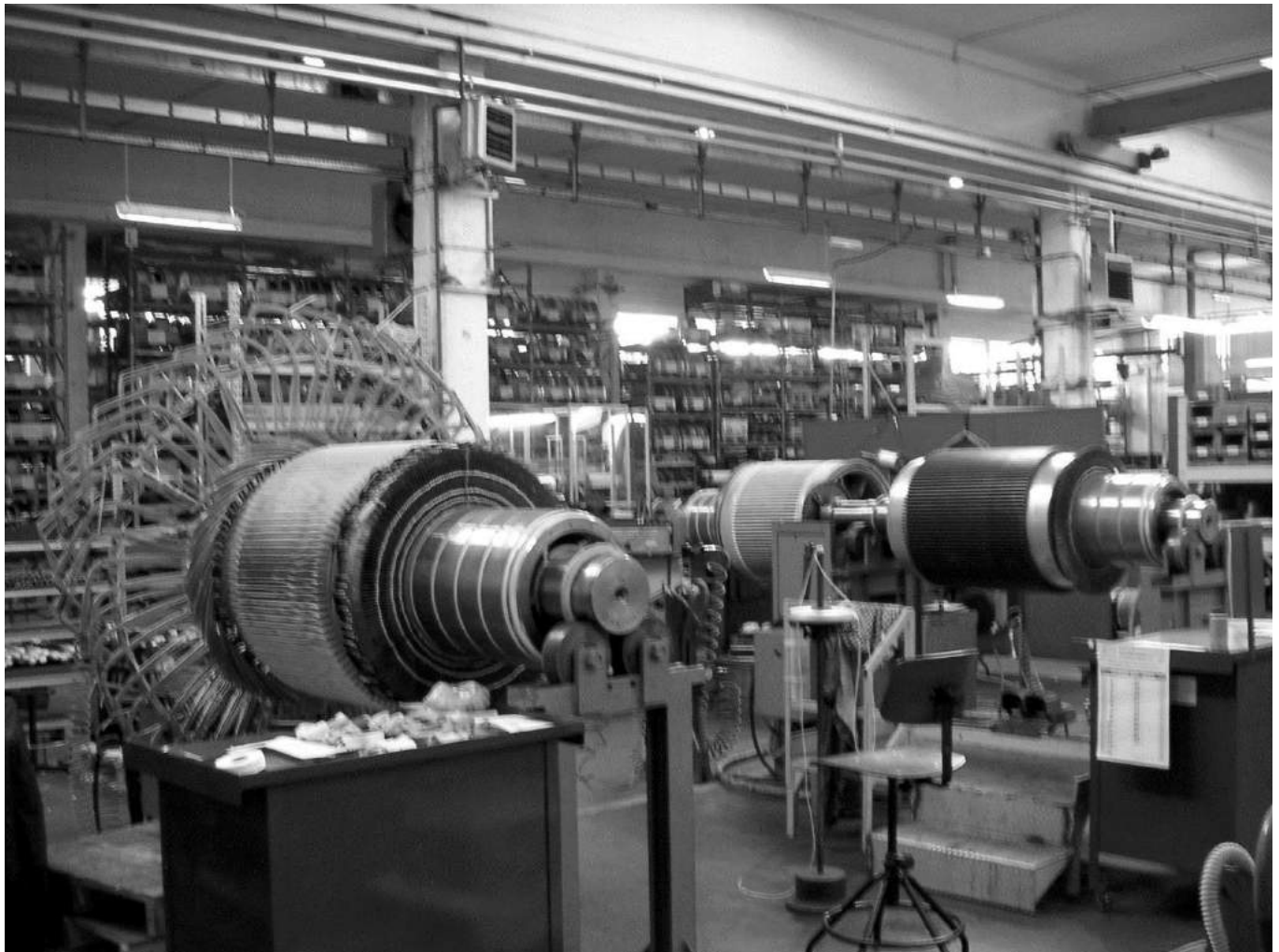
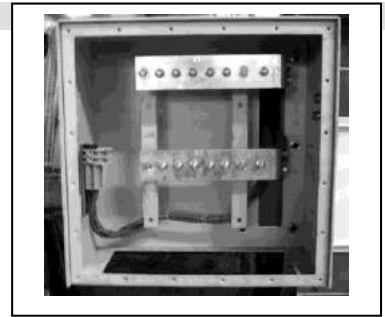

ROTAZIONE ORARIA VISTA LATO ACCOPPIAMENTO
CLOCKWISE ROTATION DRIVE END VIEW

ROTAZIONE ANTIORARIA VISTA LATO ACCOPPIAMENTO
CON INVERSIONE DI INDOTTO
COUNTERCLOCKWISE ROTATION DRIVE END VIEW
BY ARMATURE REVERSAL

MOTORE CON ECCITAZIONE SEPARATA
SEPARATE EXCITATION DIRECT CURRENT MOTOR

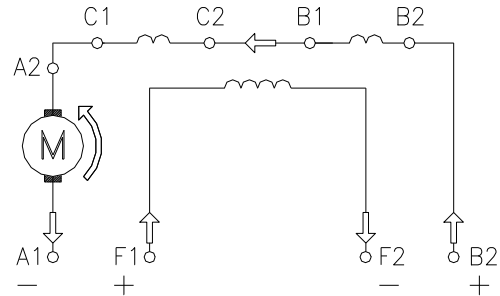
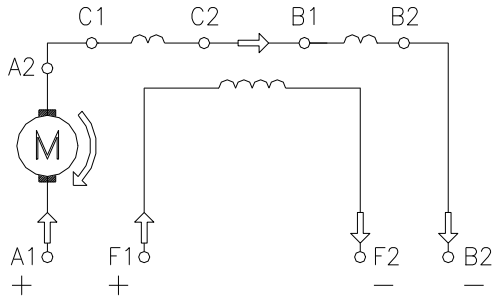

MOTORE CON ECCITAZIONE SEPARATA CON POSSIBILITA' DI COLLEGAMENTO SERIE O PARALLELO
SEPARATE EXCITATION DIRECT CURRENT MOTOR WITH POSSIBILITY OF PARALLEL/SERIES CONNECTION

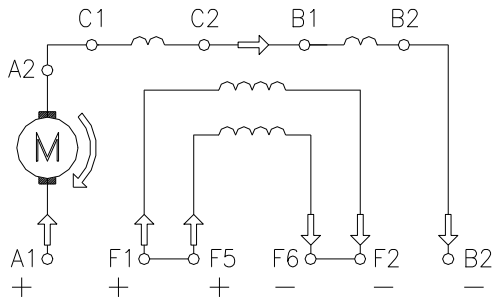

COLLEGAMENTO PARALLELO
PARALLEL CONNECTION

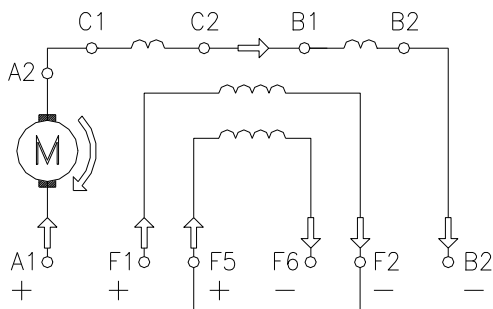
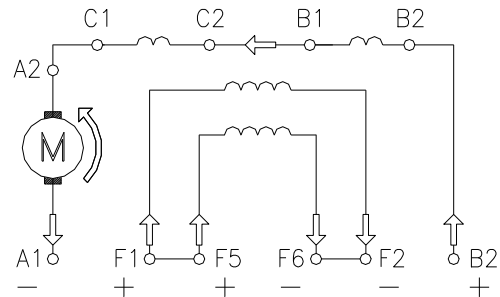

COLLEGAMENTO SERIE
SERIES CONNECTION

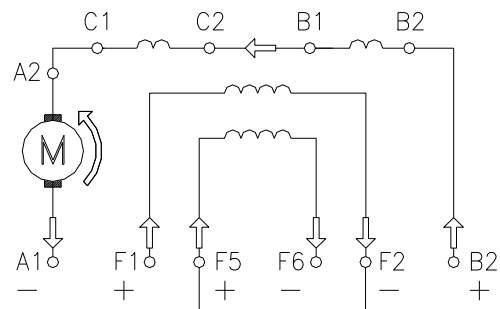

MARCATURA DEI TERMINALI CON SIGLE IEC 34-8
TERMINAL MARKINGS IN ACCORDANCE WITH IEC 34-8

NOMENCLATURA
NOMENCLATURE

AVVOLGIMENTO INDOTTO	/	ARMATURE WINDING	A1-A2
AVVOLGIMENTO POLI AUSILIARI	/	COMMUTATING WINDING	B1-B2
AVVOLGIMENTO DI COMPENSAZIONE	/	COMPENSATING WINDING	C1-C2
AVVOLGIMENTO ECCITAZIONE SEPARATA	/	SEPARATE FIELD WINDING	F1-F2 / F5-F6

A TERMINE DI LEGGE CI RISERVIAMO LA PROPRIETA' DI QUESTO DISEGNO CON IL DIVIETO DI RIPRODURLO O DI RENDERLO NOTO A TERZI SENZA LA NOSTRA AUTORIZZAZIONE.



MOTORE A CORRENTE CONTINUA GRANDEZZE 80 - 450
SCHEMA ELETTRICO MOTORE STANDARD
D.C. MOTOR TYPE 80 - 450
CONNECTION DIAGRAM FOR STANDARD MOTOR

b. 22.1.1 - 2-4 poles

ROTAZIONE ORARIA VISTA LATO ACCOPPIAMENTO CLOCKWISE ROTATION DRIVE END VIEW		ROTAZIONE ANTIORARIA VISTA LATO ACCOPPIAMENTO CON INVERSIONE DI INDOTTO COUNTERCLOCKWISE ROTATION DRIVE END VIEW BY ARMATURE REVERSAL	
MOTORE CON ECCITAZIONE SEPARATA SEPARATE EXCITATION DIRECT CURRENT MOTOR			
MOTORE CON ECCITAZIONE SEPARATA CON POSSIBILITA' DI COLLEGAMENTO SERIE O PARALLELO SEPARATE EXCITATION DIRECT CURRENT MOTOR WITH POSSIBILITY OF PARALLEL/SERIES CONNECTION			
		COLLEGAMENTO PARALLELO PARALLEL CONNECTION	
		COLLEGAMENTO SERIE SERIES CONNECTION	
MARCATURA DEI TERMINALI CON SIGLE IEC 34-8 TERMINAL MARKINGS IN ACCORDANCE WITH IEC 34-8		NOMENCLATURA NOMENCLATURE	
AVVOLGIMENTO INDOTTO / ARMATURE WINDING		A1-A2	
AVVOLGIMENTO POLI AUSILIARI / COMMUTATING WINDING		B1-B2	
AVVOLGIMENTO DI COMPENSAZIONE / COMPENSATING WINDING		C1-C2	
AVVOLGIMENTO ECCITAZIONE SEPARATA / SEPARATE FIELD WINDING		F1-F2 / F1-F6	
A TERMINE DI LEGGE CI RISERVIAMO LA PROPRIETA' DI QUESTO DISEGNO CON IL DIVIETO DI RIPRODURLO O DI RENDERLO NOTO A TERZI SENZA LA NOSTRA AUTORIZZAZIONE.			
SICMEMOTORI S.p.A. TORINO - ITALIA		MOTORE A CORRENTE CONTINUA GRANDEZZE 500 - 800 SCHEMA ELETTRICO MOTORE STANDARD D.C. MOTOR TYPE 500 - 800 CONNECTION DIAGRAM FOR STANDARD MOTOR	

b. 22.1.1 - 6-8 poles

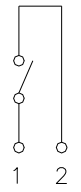
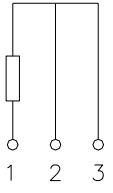
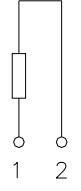
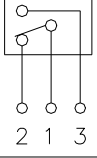
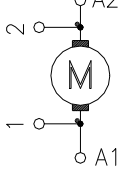
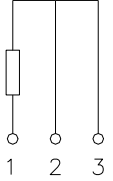
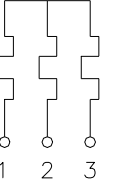
ACCESSORI INSTALLATI INSTALLED ACCESSORIES						
	NOMENCLATURA NOMENCLATURE	MARCATURA TERMINALI TERMINAL MARKINGS				
		1	2	3		
	TERMOPROTETTORE KLIXON DI INTERVENTO KLIXON THERMAL PROTECTOR FOR CUT-OFF	BOBINA POLI AUSILIARI COMMUTATING POLE WINDING	PK1	PK2		<input type="checkbox"/>
	TERMOPROTETTORE KLIXON DI INTERVENTO KLIXON THERMAL PROTECTOR FOR CUT-OFF	BOBINA POLI PRINCIPALI MAIN POLE WINDING	PK3	PK4		<input type="checkbox"/>
	TERMOPROTETTORE KLIXON DI ALLARME KLIXON THERMAL PROTECTOR FOR ALARM	BOBINA POLI AUSILIARI COMMUTATING POLE WINDING	PK5	PK6		<input type="checkbox"/>
	TERMOPROTETTORE KLIXON DI ALLARME KLIXON THERMAL PROTECTOR FOR ALARM	BOBINA POLI PRINCIPALI MAIN POLE WINDING	PK7	PK8		<input type="checkbox"/>
	TERMOSONDA PT 100 Ω 0°C DI INTERVENTO PT 100 Ω 0°C THERMAL DETECTOR FOR CUT-OFF	BOBINA POLI AUSILIARI COMMUTATING POLE WINDING	PT1	PT2	PT3	<input type="checkbox"/>
	TERMOSONDA PT 100 Ω 0°C DI INTERVENTO PT 100 Ω 0°C THERMAL DETECTOR FOR CUT-OFF	BOBINA POLI PRINCIPALI MAIN POLE WINDING	PT4	PT5	PT6	<input type="checkbox"/>
	TERMOSONDA PT 100 Ω 0°C DI ALLARME PT 100 Ω 0°C THERMAL DETECTOR FOR ALARM	BOBINA POLI AUSILIARI COMMUTATING POLE WINDING	PT7	PT8	PT9	<input type="checkbox"/>
	TERMOSONDA PT 100 Ω 0°C DI ALLARME PT 100 Ω 0°C THERMAL DETECTOR FOR ALARM	BOBINA POLI PRINCIPALI MAIN POLE WINDING	PT10	PT11	PT12	<input type="checkbox"/>
	TERMOSONDA PTC DI INTERVENTO PTC THERMAL DETECTOR FOR CUT-OFF	BOBINA POLI AUSILIARI COMMUTATING POLE WINDING	PC1	PC2		<input type="checkbox"/>
	TERMOSONDA PTC DI INTERVENTO PTC THERMAL DETECTOR FOR CUT-OFF	BOBINA POLI PRINCIPALI MAIN POLE WINDING	PC3	PC4		<input type="checkbox"/>
	TERMOSONDA PTC DI ALLARME PTC THERMAL DETECTOR FOR ALARM	BOBINA POLI AUSILIARI COMMUTATING POLE WINDING	PC5	PC6		<input type="checkbox"/>
	TERMOSONDA PTC DI ALLARME PTC THERMAL DETECTOR FOR ALARM	BOBINA POLI PRINCIPALI MAIN POLE WINDING	PC7	PC8		<input type="checkbox"/>
	MICROSWITCH PER CONTROLLO USURA SPAZZOLE TIPO MC1 ED MC1p MICROSWITCH FOR BRUSHES WEAR CONTROL DEVICE TYPE MC1 AND MC1p		MK1	MK2	MK3	<input type="checkbox"/>
	USCITE PER CONTROLLO USURA SPAZZOLE DA CABLARE AL RELE' AI2 BRUSHES WEAR CONTROL TERMINALS TO CONNECT TO AI2 RELAY		A11	A21		<input type="checkbox"/>
	TERMOSONDA PT 100 Ω 0°C CUSCINETTO LATO ACCOPPIAMENTO PT 100 Ω 0°C THERMAL DETECTOR ON DRIVE END BEARING		RK1	RT1	RS1	<input type="checkbox"/>
	TERMOSONDA PT 100 Ω 0°C CUSCINETTO LATO COLLETTORE PT 100 Ω 0°C THERMAL DETECTOR ON COMMUTATOR END BEARING		RK2	RT2	RS2	<input type="checkbox"/>
	RESISTENZA ANTICONDENSA TRIFASE THREE-PHASE SPACE HEATER		R1	R2	R3	<input type="checkbox"/>
	RESISTENZA ANTICONDENSA MONOFASE SINGLE-PHASE SPACE HEATER		R1	R2		<input type="checkbox"/>
NOTE :						

b. 22.2

B.23 Painting of finished products

SICMEMOTORI has standardized certain painting cycles, which should be chosen considering the machine operating environment. Any other cycles may be defined in agreement with the Customer when ordering. The final standard colour is green RAL6011; other colours are available upon prior agreement when ordering.

B.23.1 Preparation of the surfaces

Regardless of the specified painting cycle, all the machines undergo surface preparation treatment to ensure excellent adherence of the paint. The shields and terminal boxes are always degreased and painted with one or more coats of epoxy primer; the lids and hatches are treated with electrolytic galvanising; the wound stator packs are covered with impregnation insulating paint which acts as a perfect base coat; the cooling systems (fans, heat exchangers) are degreased and painted with primer. Thus all parts of each machine have received at least one coat of primer in preparation for final painting with the specified finish.

B.23.2 Standard painting cycles

The painting cycles standardised by SICMEMOTORI are described in table b.23.2. The primer adherence index is 1 (according to DIN Std.53151). The paints used contain no lead, chromium or zinc or their components. Technical characteristics of paints are available on request to SICMEMOTORI. The Customer must previously check if the paint cycle is suitable for its application. In lack of other instructions, all machines are painted according to cycle 1.

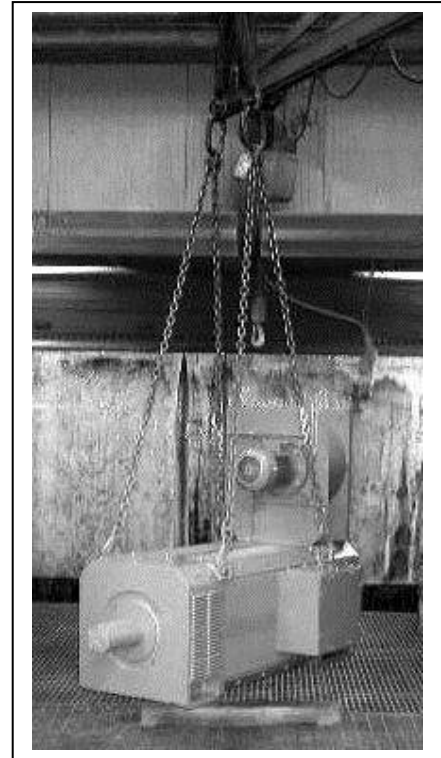

Cycle	Environment	Application
1 (normal)	Indoor, dry, clean, not aggressive (see B.04)	- degreasing with spray solvent - synthetic nitrous enamel finishing coat - minimum thickness 15 micron
2 (anticorrosive)	Damp-salty, tropical, sea, near sea	- degreasing with spray solvent - 1 coat of epoxy primer - 1 coat of enamel semi-gloss finishing coat - minimum thickness 90 micron
3 (anticorrosive special for aggressive environment)	Chemically aggressive, naval	- free jet shotblasting with GH 50 carbon steel grit to obtain SA 2 ½ degree of cleaning - 2 coats of epoxy primer - 2 epoxy semi-gloss enamel finishing coats - minimum thickness 130 micron
4 (special)		To be defined with the Customer when ordering

Table b.23.2

B.24 Main data plate

Main data plate is in stainless steel and it is solidly rivetted to the motor frame.
 Languages Italian/English (standard), Italian/French or Italian/German are available when ordering. Other languages are available on request when ordering (please ask SICMEMOTORI).
 Data on name plate are according to IEC 60034-8.



Meaning of the abbreviations

TIPO/TYPE	motor type (according to SICMEMOTORI code; please refer to par.A.06)
N	serial number
P	nominal power
VEL/SPEED	speed
ARM/ARM(V)	armature voltage
ARM/ARM (A)	armature current
CAMPO/FIELD (V)	field voltage
CAMPO/FIELD (A)	field current
MASSA/MASS	motor weight complete with cooling devices
J(kgm ²)	rotor moment of inertia
ANNO/MESE - YEAR/MONTH	year/month of construction
SERV/DUTY	duty
IP	degree of protection
IC	cooling method
IM	form of construction
CL.ISOL/INS.CL	insulation class (the temperature rise is also given if different than class H)
TEMP.AMB/AMB.TEMP.	ambient temperature
CUSC.LA/DR.END BEAR.	drive end bearing
CUSC.LO/COMM.END BEAR.	non drive end bearing
INT.LUBR/LUBR.INT.	bearing lubrication interval

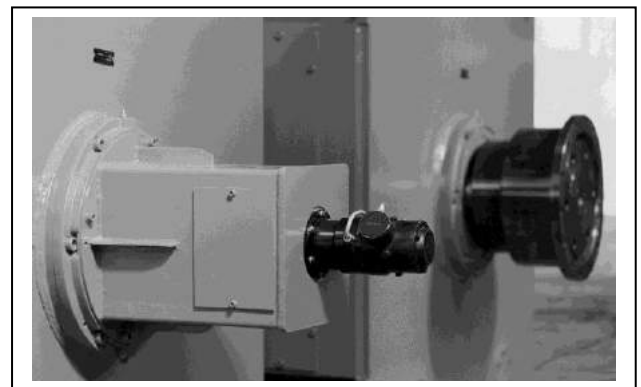

C. ELECTRICAL CHARACTERISTICS AND PERFORMANCE RATINGS

C.01 Form factor, ripple and dissymmetry of the armature current

The ratio between the effective value I_e and the mean value I^m of the current is defined as the **Form Factor ff**. For perfectly continuous currents, I_e and I_m coincide, therefore $ff = 1$.

If the current is not perfectly continuous, I_e is greater than I_m and ff is higher than 1.

The fact that I_e is greater than I_m causes an increase in the heating of the circuits with respect to what would occur with $I_e = I_m$, thus $ff = 1$.

The presence of an alternating component in the armature current also tends to adversely affect commutation, because it introduces an instantaneous lag between the current itself and the flux produced by the auxiliary poles and compensating windings.

The machines in this catalogue have the magnetic stator circuit completely laminated so that this lag is minimised and they are suitably sized from the thermal point of view so that they can operate correctly under all the load and overload conditions and through the whole speed range specified, provided that the ff of the armature current is:

≤ 1.05 for three-phase fully controlled bridge supply;

≤ 1.4 for single-phase fully controlled bridge supply.

The **ripple R_p** of a current I is the ratio between the effective value of the alternating component I_{ea} and its mean value I_m expressed as a percentage:

$$R_p\% = 100 \times I_{ea} / I_m$$

The ripple is a quantity to which reference is often made in electronics. The conversion from the Ripple to the Form Factor of a current is obtained as follows:

$$ff = \sqrt{1 + (R_p\% / 100)^2}$$

The alternating component of the armature current is not generally perfectly symmetrical, due to factors inside the converter.

This **dissymmetry** has consequences both on motor heating and on commutation capability, and it must therefore be contained within approx. 10% of the nominal current rating (dwg. c.01).

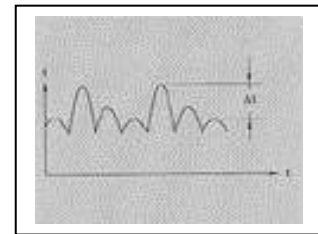

c.01

C.02 Armature current with rotor locked

The direct current motor can be required to supply a torque even at standstill, in which case it needs to be appropriately energised and the armature circuit must be conducting current.

The limits to the value of this current and its duration in time are of a thermal nature, meaning that the heating in the contact area between brushes and commutator can lead to localised changes of the molecular structure of the commutator surface.

For preliminary assessment of the possibility of a machine to cope with this kind of operating conditions, refer to table c.02. For application requirements outside the standard range, please consult SICMEMOTORI.

Current % (*)	Duration
200	10 sec
100	30 sec
50	90 sec
20	10 min
10	Continuous

Table c.02

(*) percentage with respect to the nominal rating

C.03 Current gradient

Automatic control systems associated with static rectifiers often involve sudden 'step' changes of the reference signal, followed by transient stages during which the limit current allowed by the system is established extremely rapidly, which persists until the value set for the controlled quantity is reached. The current gradient dI/dt in relation to time mainly affects commutation, and it is very important that the machines built into modern systems be capable of coping with high dI/dt values without impairment. The machines in this catalogue can withstand extremely rapid current changes, with gradient up to $200 I_n/\text{sec}$ (the permitted rate of change allows the current to pass from 0 to the nominal rating in $1/200^{\text{th}}$ of a sec).

C.04 Compensating windings

The electrical machine is often required to supply or to absorb the shaft torque above the nominal rating as motor or generator.

This occurs when the coupled load requires it, and also during acceleration and deceleration, when the torque needed to change the speed of the inertia is added to the load torque.

At nominal excitation, torque and current are roughly proportional, but the 'armature reaction' caused by the current that circulates in the armature tends to reduce the flux generated by the main poles, thereby making more than proportional armature current necessary to obtain a certain torque.

In order to dramatically reduce the effects of the 'armature reaction' and make torque delivered almost linearly proportional to the armature current, the compensating winding is added on the stator, which embraces pairs of adjacent poles and conducts the armature current itself.

A not compensated machine is generally less expensive, but the corresponding static converter is often more expensive: in fact its 'power device' must be sized for the maximum current required, even if of short duration.

Compensating windings are not available for sizes 80-112.

Sizes 132-250 are available both with and without compensating windings.

Sizes 280-800 are always with compensating windings.



C.05 Overloads in torque and current

The maximum torques and currents and their allowable duration for the machines in this catalogue are given in table c.05.

With regard to the duration, the root mean square current rating I_{rms} must never exceed the nominal current rating I_n (see C.08).

T max	I max	Duration
1.6	Standards IEC 60034-1 Not stated	1' occasional
1.6	Not compensated machines 2	15" every 5' or 1' every 20'
1.9	Compensated machines 2	15" every 5' or 1' every 20'

Table c.05

C.06 NEMA Standards overload capability

All P-NP machines can electrically comply with NEMA MG.1-23.41 Standards.

In particular, motors can be selected according to the following loads, with successful commutation (metal rolling mills, excluding reversing hot mills, open, forced ventilation IC06 or totally enclosed with air-water cooler IC86W):

- 115% of rated load continuously at rated voltage throughout the rated speed range; under this load, temperature rises will be higher and other characteristics may differ from those specified for operation under rated conditions
- 125% of rated load for 2 hours at rated voltage throughout the rated speed range, following continuous operation at rated load, without exceeding the temperature rises specified for operation at rated load; other characteristics may differ from those specified for operation under rated conditions
- the following momentary (1 minute) loads:

% of base speed	% of rated load	
	Occasionally applied *	Frequently applied **
100	200	175
200	200	160
300 or over	175	140

* Occasionally applied momentary load capacity: denotes the ability of a motor to carry loads in excess of its continuous rating for a period not to exceed 1 minute on an infrequent or emergency basis

** Frequently applied momentary load capacity: denotes the ability of the motor to carry loads in excess of its rating on a repetitive basis, such as a part of a regular duty cycle.

Important: operation at the momentary or frequently applied loads must be followed by light load operation such that the rms load value of the complete load cycle does not exceed the continuous motor rating. Also, the time of operation at momentary or frequently applied loads must be limited to a period such that rated temperature rise is not exceeded.

For selecting motors according to abovementioned NEMA Standards (or according to NEMA Standards for reversing hot mills), please always ask SICMEMOTORI.

C.07 Excitation

The ampere turns required to generate the flux of the direct current machine are produced by the excitation current (field current) which circulates in the coils of the main poles (excitation or field windings).

The latter is normally connected to a different rectifier than the armature, thereby obtaining "separate excitation". The rectifier for the excitation circuit can be either a simple rectifier with nominally constant voltage, or a true "voltage regulator", when speed adjustment above base speed is required (see C.09.3).

If the excitation winding is supplied from the same source as the armature, "shunt excitation" is obtained.

If a suitable excitation winding is connected in series to the armature winding so that the armature current also becomes excitation current the result is "series excitation".

A series winding can be used in combination with the main separate or shunt excitation winding, thereby forming "separate plus series stabilizing" or "compound excitation".

Separate excitation plus stabilizing winding is usually specified when there is: the need to have particularly high starting torques; to enhance the stability inherent in the mechanical characteristic up to the maximum pre-determined loads (independent of any stabilizing action of supply and control itself, for example through tachometric control); need to balance the mechanical characteristics of different motors operating in parallel; etc..

Normally the motors of this catalogue are supplied with separate excitation. This type of excitation makes it possible to regulate the motor speed, increasing it with respect to the nominal value, by the utilisation of a static converter. A reduction of the field voltage (current) gives as result an increasing of the motor speed (field weakening) at constant power (refer to Appendix 4f).

The other types of excitation are available on request.

C.08 Forcing of the independent field

The independent field circuit generally has a high inductance with respect to the resistance, hence a high time constant.

Because of this, when the excitation voltage is applied the corresponding current is not established instantaneously, but it grows exponentially up to the normal operating value.

To reduce the time needed to reach the required excitation rating, forcing can be carried out by applying a higher voltage than the nominal rating to the field in the transient stage.

For the machines in this catalogue, the maximum allowed forcing voltage is 1.5 x nominal.

For higher forcing rates, enquiries should be made with SICMEMOTORI.

Regardless of the forcing rate of frequency of repeated forcings, the root mean square value of the excitation current should never exceed the nominal rating.

C.09 Rotation speed

The direct current machine excited and supplied at a certain armature voltage V_a tends to set itself in motion and reach such a speed that the back e.m.f. force that is generated inside balanced the actual V_a (operating as motor).

C.09.1 Base speed

This is the speed obtained supplying the armature at nominal voltage and circulating the nominal excitation current in the excitation winding, when the load requires nominal torque from the shaft.

Thus the base speed is the equivalent of nominal speed.

C.09.2 Minimum speed

To reduce speed below the base speed the armature voltage must be reduced with excitation constant. Under these conditions, since the machine conducting by nominal armature current, it can deliver nominal torque to the shaft: thus speed change below the nominal speed is also said to be at constant torque.

Since the armature current is constant, losses due to the Joule effect in the windings remain roughly constant, thus the machine can work in continuous service at reduced speed and nominal torque only if the cooling system so permits (i.e. if its effectiveness is independent of rotation speed).

This is normally the case for the machines in this catalogue. The minimum speed for continuous operation depends on the importance given to regularity of shaft rotation (constant angular speed during the turn), and on the total moment of inertia (motor and coupled load): roughly operation down to a few tenths of a turn per minute may be considered acceptable.

C.09.3 Maximum speed under field weakening

The maximum speed that is permitted above base speed is essentially limited by commutation requirements, as shown by the curves given in the performance tables in the technical catalogues, and it must never exceed the maximum mechanical speed allowed (given in technical catalogues too).

To rise above the base speed, the excitation current needs to be reduced with the armature voltage constant. Since the machine is supplied at nominal armature voltage, under these conditions it can deliver nominal power to the shaft: hence, speed change above the base speed is said to be "at constant power". In practice, there are technical factors which place an effective on the highest speed at which true constant power operation is possible with any given armature winding. Beyond this speed, operation is usually possible at a reduced power rating which may nevertheless be adequate.

Accordingly, the necessary derating curves are shown in the technical catalogues adjacent to the associated power rating tables.

C.10 Power

In electrical machines the 'output power', i.e. the power leaving the actual machine is taken into consideration. In a motor, the electric power is that supplied by the shaft which equals the product of torque by rotation speed.

Conversely, in a generator, the output power is that supplied at the terminals when the machine, connected to an electrical load and duly energised, is kept in rotation by a prime mover: the output power from a generator equals the product of the voltage at the terminals by the current delivered.

The output power corresponds to an absorbed power (electric in the case of a motor, mechanical in the case of a generator) which is increasingly higher as the efficiency of the machine reduces below 1.

C.10.1 Nominal power

This is the power that a machine supplied (excited) under nominal conditions can deliver in continuous service at nominal speed without exceeding the overtemperatures allowed by its insulation system.

For a variable speed direct current motor (the most common case) the nominal power can be of little interest.

In fact, repeated speed changes during service involve acceleration and deceleration torques (and currents) which are added to those of the load; additionally, in the case of self-ventilated machines there is a reduction of the heat dispersion capability when the speed is below the nominal rating.

Also generators can be subjected to overloads of amount and duration that cannot be neglected which prevent utilisation of the nominal continuous rated power.

C.10.2 Equivalent thermal current

The equivalent thermal current I_{te} of a current no matter how variable during a defined period of time (cycle) is the constant current that has the same thermal effect (heating of the elements of the circuit due to the Joule effect) as the current given. If the effective current can be represented with sufficient accuracy in relation to time by a series of horizontal lines of different heights, I_{te} is calculated simply by the following formula:

$$I_{te} = \sqrt{\frac{I_1^2 \times t_1 + I_2^2 \times t_2 + \dots + I_n^2 \times t_n}{t_1 + t_2 + \dots + t_n}}$$

A formula of this type can be reached with some acceptable simplification in most practical cases (fig.c.10.2). It is interesting to note that the 'sign', i.e. the direction of the current (thus of the torque if the flux does not invert) does not affect the equivalent thermal current, as all the current values in the formula are squared.

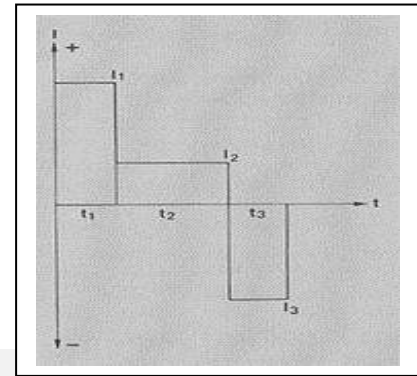

C.10.3 Equivalent thermal power

If one associates the nominal voltage of the machine with an equivalent thermal current I_{te} , a P_{te} is obtained, i.e. an equivalent thermal power.

This can be a good guide in the preliminary choice of the machine.

C.11 Different types of duties

IEC Std. 60034.1 defines a certain number of Services for electric motors (designated with an abbreviation from S1 to S10), with reference to the course of the output power over time.

Because of the above considerations, the application of these Standards to direct current machines is not always possible without suitable adjustment (through preliminary calculation of the equivalent thermal current, examination of the particular type of cooling specified).

The purchaser is always responsible to declare the duty; in case the duty is not declared, SICMEMOTORI assumes that duty S1 (continuous running duty) applies.

Please refer also to Appendix (paragraph 2).

C.11.1 Continuous running duty – Duty type S1

This consists in constant continuous service which lasts at least until thermal balance with the environment is reached (constant overtemperature).

This service condition is referred to when speaking about nominal power, and the performance rates of the machines in this catalogue refer to this condition.

Except where otherwise stated, service S1 is considered achieved under nominal supply (armature voltage, excitation current) and load conditions (nominal torque) with constant environment temperature.

C.11.2 Short-time duty – Duty type S2

This consists in loaded service for a limited amount of time, below that required for reaching thermal balance. The shorter the time taken into consideration, the higher the allowed load with respect to that of service S1. The end of this time must necessarily be followed by an adequate cooling period.

Times normally considered are 30 min and 60 min.

C.11.3 Intermittent or continuous periodic duties , other duties

These are duties known as S3 and over (up to S10) by the above-mentioned Standards. The definition of these duties is given in the IEC 60034-1Standards. Please refer also to Appendix (paragraph 2).

C.11.4 Service Factor

The Service Factor is used especially in environments influenced by the American Technical culture to give a quantitative indication of the continuous overload capability of the machines, beyond the overtemperature ratings allowed by reference Standards, but always within limits which warrant satisfactory life of the actual machines. It is however clear that operating the machines above their nominal power even within the limits of the guaranteed Service Factor, should only be an exceptional occurrence, to be limited to the time strictly indispensable for adapting the installed capacity.

C.12 Power rating variation with different environmental conditions

The data given in technical catalogues are valid under the following environmental conditions:

- max. environment temperature 40°C;
- max. altitude of installation 1000 m. above sea level

Environment temperatures above 40°C involve a reduction of the power rating available at the motor shaft (or at the generator terminals), to maintain the winding overtemperature within the limits established by the Standards.

If the machine is to operate at an altitude of over 1000 m. above sea level (up to 4000 mt) it is jointly admitted , unless otherwise agreed between the parties, that the effects of the altitude and of the reduced temperature compensate one another.

C.13 Power rating variation with different types of cooling

The data given in technical catalogues are valid for the types of cooling given in table c.12. Other types of ventilation cause a reduction of the power available at the motor shaft (or generator terminals) to compensate the lower effectiveness in ventilation.

IC	SICMEMOTORI code	IC	SICMEMOTORI code
06	PVA	17	BCA
16	BPVA	37	CBA
36	BPVAB	86W	CBARH

Table c.13

C.14 Power rating variation with different allowed temperature rise

The data given in technical catalogues are valid for class H temperature rise (same as the insulation class).This means that the hottest parts of the windings can reach an absolute temperature of 165°C (40°C environment temperature plus 125°C allowed by Standards for the insulating materials of class H).

Sometimes the winding temperature rise is requested to be limited to lower ratings, relating to class F or B (or intermediate).

In this case, the powers available at the motor shaft (or generator terminals) must be reduced to contain in the temperature rise within the established limits.

C.15 Corrective coefficients

These are the coefficients that need to be used to bring the power ratings (and speed) required by the application to values compatible with the power and speed data given in technical catalogues, when the type of service, ventilation, environment temperature and temperature rise differ from the standard ones indicated in the previous paragraphs. The various coefficients are multiplied together when multiple deviations from standard occur, obtaining 2 overall coefficients:

- coefficient K_p referring to the power;
- coefficient K_n referring to the speed.

To select a frame size suitable for required power/speed:

- the power rating to be found in the technical catalogues should be divided by K_p .
- the speed rating to be found in the technical catalogues should be multiplied by K_n

C.15.1 Corrective coefficients for duties other than S1 (table c.15.1)

Care should be taken to ensure that the ratio between maximum torque and nominal torque does not exceed 1.9 for compensated machines nor 1.6 for not compensated machines.

C.15.2 Corrective coefficients for different types of cooling

Please refer to table c.15.2.

Duty	K_p	K_n
S1	1	1
S2-60'	1,12	1
S2-30'	1,2	1
S3-60%	1,15	1
S3-40'%	1,25	1

Table c.15.1

IC	SICMEMOTORI code	K _p	K _n
06-16-36	PVA-BPVA-BPVAB	1	1
17-37	BCA-CBA	1	1
86W	CBARH	1	1
666	CBARO	0.77	0.86

Table c.15.2

C.15.3 Corrective coefficients for temperature rise different than class H

Please refer to table c.15.3.

Delta T	K _p	K _n
Class H (125 °C)	1	1
Class F (105 °C)	0.91	0.95
Class B (80 °C)	0.8	0.89

Table c.15.3

C.15.4 Corrective coefficients for ambient temperature >40 °C and altitude > 1000 m.a.s.l.

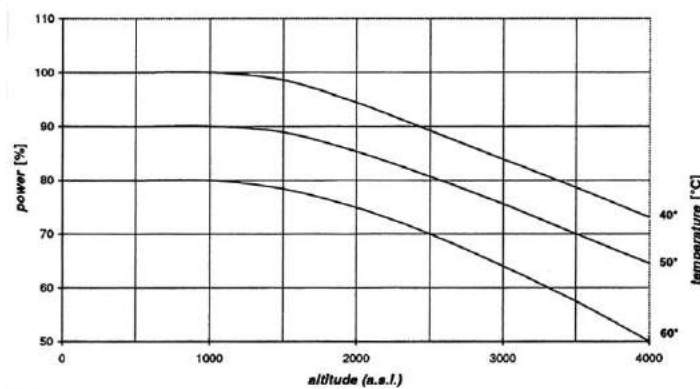

When ambient temperature is > 60°C and altitude is > 4000 m.a.s.l., please ask SICMEMOTORI.

C.16 Examples of choice of motors

1 – Motor with separate excitation, with no field weakening.

- P = 440 kW
- n = 1300 RPM
- V = 440 V

Ambient temperature 40 °C – Degree of protection IP23 – Type of cooling IC06-PVA

Duty S1 – Mounting IM1001 (B3)

Insulation and temperature rise class H

There are no corrective coefficients to be considered.

Checking in the performance tables on the technical catalogues it is found that the motor NP280KM winding 45 gives 440 V 450 kW at 1299 g/1'.

Looking at the appropriate table we find the integrating code for winding 45 is 6.

So that the motor to offer is:

NP 280 KM6-PVA/B3.

2 – Motor with separate excitation, with field weakening.

- P = 130 kW
- n = 700/1200 RPM at constant power
- V = 400 V

Ambient temperature 40 °C – Degree of protection IP23 – Type of cooling C06-PVA

Duty S1 – Mounting IM1001 (B3)

Insulation and temperature rise class H

There are no corrective coefficients to be considered.

The first thing to look for on the performance tables in technical catalogues is the motor with winding able to supply 130 kW at 700 RPM.

We find that motor NP250KS winding 55 supplies 146 kW at 691 RPM with 400 V.

Now, we take a look at what happens on the field weakening curve for winding 55 at 1200 RPM (on technical catalogues too).

We find a K_p of 0.9, thus the power this motor is able to supply at 1200 RPM is:

$$146 \times 0.9 = 131.4 \text{ kW}$$

This value is still higher than the 130 kW required, therefore the motor is suitable for supplying the performance rating required.

The selection code for winding 55 is 5, therefore the motor to offer is:

NP 250 KS5-PVA/B3.

D. COMPANY QUALITY SYSTEM – TESTS, CONTROLS, INSPECTIONS**D.01 Quality Control Dept.**

The manufacturing process is controlled by the Quality Control Dept., which is responsible for the correct execution of the tests and inspections specified by the Company Quality System, set out and defined by the "Quality Assurance" dept.

The company Quality System is certified and controlled by the CSQ (*) in compliance with European Standards ISO 9001. At the time of going to press environmental certification EN 14001 is in progress.

(*) The CSQ Quality Certification Systems is run by IMQ in collaboration with CESI, it forms part of the CISQ convention (Italian Certification of Quality System) and adheres to the EQNET International agreement.

D.02 Routine tests

All P-NP machines are subjected to routine checks and tests at the end of the production cycle, on the basis of the list of tests in the card shown in table d.02.

The corresponding test Protocol is supplied with all motors.

Visual inspection of conformity to design
Measurement of windings resistance
Continuity test of auxiliary circuits
No load test
Test at nominal load and speed and visual check of commutation (for frames 225-800 only)
Overspeed test
High voltage test
Check of accessories

d.02

D.03 Type tests

The type tests are carried out on the first machine of a series, and the values revealed are used as reference during the routine tests of the following ones of the same series.

At the time of ordering the Customer may ask for a machine to be subjected to the type tests (surcharge).

The list of type tests is given in table d.03.

Visual inspection of conformity to design
Measurement of windings resistance
Continuity test of auxiliary circuits
No load test
Test at nominal load and speed and visual check of commutation
Heating test
Determination of efficiency (with the indirect method)
Overspeed test
Voltage test with hot machine
Recording of the no-load magnetisation characteristic
Recording of field weakening characteristic (for field weakened motors)
High voltage test
Check of accessories

d.03

D.04 Special tests

The performance of one or more of the tests listed in table d.04 must be agreed upon at the time of ordering and will involve a surcharge.

Measurement of noise level
Measurement of vibrations
Measurement of armature winding inductance
Measurement of field winding inductance

d.04

D.05 Witnessed tests

Tests carried out in the presence of a Customer or authorised body must be requested at the time of ordering and will involve a surcharge.

QUALITY POLICY

Top Management at Sicme Motori is aware that markets have become increasingly more demanding as far as performance, quality, reliability, safety, promptness, punctuality, flexibility and control of product costs are concerned.

Top Management is also convinced of the paramount importance of meeting these demands. It therefore intends to tackle the subject of Quality globally and dynamically and resort to the modern concepts of Total Quality and Continuous Improvement. Lean Production and Learning Organization are the two tools they will use to ensure that this process is successful.

Sicme Motori considers Quality to be a corporate strategic tool for achieving Effectiveness and Efficiency and intends to pursue it in all the company's activities. It will apply the principle of prevention in order to satisfy all Customer requirements and expectations.

Sicme Motori shall be directly responsible for the Quality of its Company's products, processes and services, apply the measures to all Company Business correctly and ensure that they are correctly interpreted and applied.

To ensure that Quality Policy is enforced, Sicme Motori has decided to implement and maintain a Quality Management system that complies with the UNI EN ISO 9001 Standard.

To ensure that the system continues to operate in a satisfactory manner, the System Management Manager in person has been nominated Quality Management Representative.

A description of Sicme Motori's Quality Management System is found in this Quality Manual. This is the guide that all levels and functions in the organization use for reference.

The Quality objectives that are consistent with the aforementioned Policy are assigned to suitable levels of the Organization and reviewed on an annual basis by Top Management.

**The Chairman
Ing. Alberto Sola**

**Quality Manager
Bruno Mingazzini**



E. ACCESSORIES

E.01 Accessories for cooling

A description is given of the cooling accessories required to develop the various versions in the catalogue (see B.05).

E.01.1 Fitted electric fan

The fan comprises a heavy gauge, welded and reinforced steel scroll and fan wheel shrunk onto the motor shaft and dynamically balanced to grade Q = 2.5. The asynchronous, three-phase motor is standardised (EEC) with degree of protection IP 55, form B5 (IM3001), 2 poles (for sizes 80-280) or 4 poles (for sizes 315-630), with 6 terminals for star (400 V) or delta (230 V) supply, 50 Hz. Special voltages and/or frequency may require a surcharge and longer term of delivery (please ask SICMEMOTORI). Motors frame 710-800 have tandem fans, 2 poles.

The main data for the electric fans and the ventilation data for ducted motors are given in Technical catalogues.

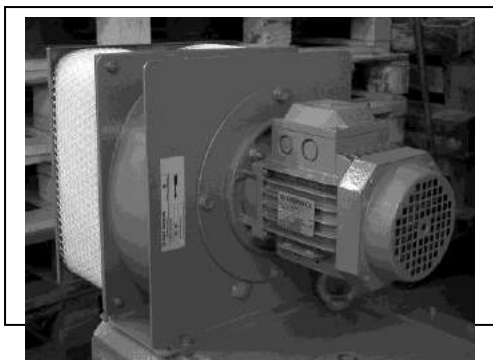

e.01.1

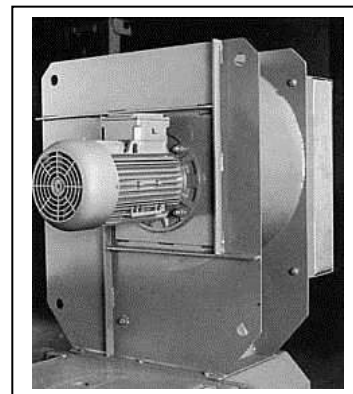

For all P-

always complete of filter (see E.01.1.1).

E.01.1.1

The inlet (VILEDON)
The main
Filtration
Average
In special



comprises a washable, self-extinguishing, non-woven panel of synthetic fibre
The standard filters according to EN 779, are the following:

environments (sugar-refineries, raw material stores, etc.), it is wise to use special filtering panels (metal, double, etc). In such cases enquiries should be made to SICMEMOTORI. Table e.01.1.1 shows the sizes of the filters for the P.NP machines in the PVA-IC06 version.

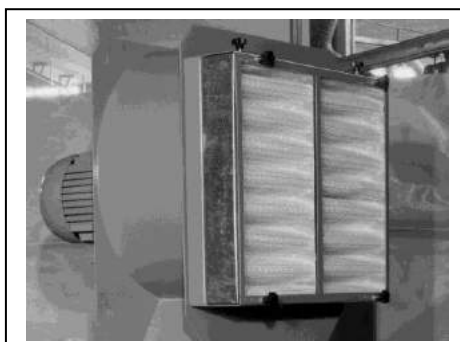
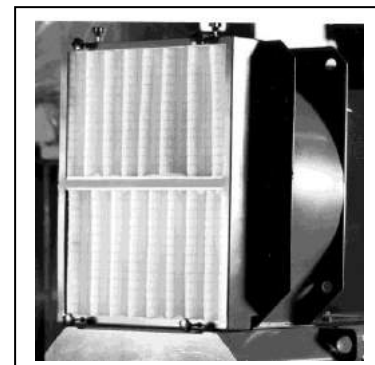
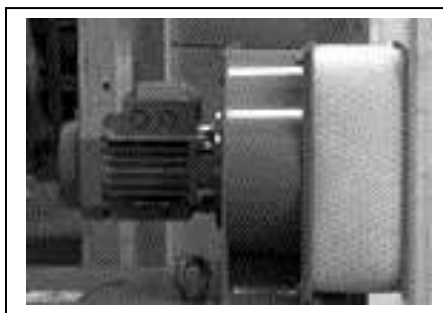
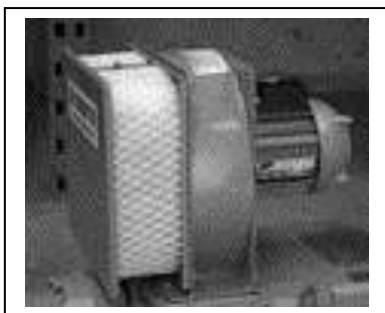

E.01.1.2 Ventilation failure detector

This device is HUBA 625-90-40 (SICMEMOTORI code 8.1.59.1.006) which acts according to the principle of the differential pressure switch and is capable of signaling when the cooling air flow falls below minimum values that are no longer sufficient to cool the direct current machine correctly, caused for example by clogging of the filter.

For PVA, BPVA and BPVAB machines it is fitted on the fan scroll.

The degree of protection of this device is IP 54 and it has a changeover contact capable of breaking 1 A current at 250 Vac. The ventilation failure detector is set by SICMEMOTORI and the adjustment screw is sealed to prevent tampering.

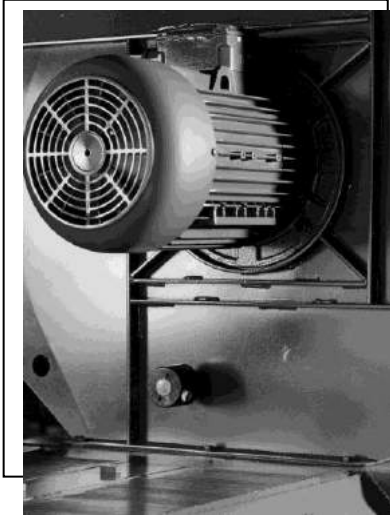

Motor	Dimensions	SM code	Qty.
80	650 x 65 x 15*	1.33.0.9.04.01	1
90	750 x 75 x 15*	1.34.0.9.04.01	1
100	835 x 90 x 15*	1.35.0.9.04.01	1
112	895 x 100 x 15*	1.36.0.9.04.01	1
132	990 x 110 x 15*	1.38.0.9.04.01	1
160	1180 x 125 x 15*	1.40.0.9.04.01	1
180	1390 x 140 x 15*	1.41.0.9.04.01	1
200	1590 x 220 x 15*	1.42.0.9.04.01	1
225	1755 x 250 x 15*	1.43.0.9.04.01	1
250	500 x 500 x 100	8.5.60.10.007.0	1
280	625 x 500 x 100	8.5.60.10.008.0	1
315	625 x 500 x 100	8.5.60.10.008.0	1
315-8	400 x 625 x 100	8.5.60.10.006.0	2
355	400 x 625 x 100	8.5.60.10.006.0	2
400	400 x 625 x 100	8.5.60.10.006.0	2
450	500 x 400 x 100	8.5.60.10.005.0	4
500	500 x 400 x 100	8.5.60.10.005.0	4
560	500 x 500 x 100	8.5.60.10.007.0	4
630	400 x 625 x 100	8.5.60.10.006.0	6
710	800 x 800 x 100	1.8.70.9.04.01.0	2
800			

* filtering cloth

Table e.01.1.1

E.01.1.3 Spacer for electric fan

This is a section of duct with two flanges for connection to the air inlet vent in the motor and to the fan delivery vent. It may be necessary when the fan and the terminal box are required on the same side of the direct current machine, to prevent interference.

E.01.2 Air-water heat exchanger

The standard heat exchanger is mainly comprised of a cooling battery of copper pipes for the circulation of water and a surrounding pack of aluminium vanes through which the air passes. Before reaching the cooling battery the air, which is circulated by an electric fan, passes through a removable, washable and self-extinguishing VILEDON filter (see E.01.1.1). The water must be soft, industrial water with a maximum inlet temperature of 26° C and a maximum inlet pressure of 7 bar. For higher temperatures or different types of water (e.g. salty) please ask SICMEMOTORI. The environmental temperature in the place of installation must be between +5 and 40° C. For other temperatures please ask SICMEMOTORI.

The main specifications concerning air-water heat exchangers are given in technical catalogues

The exchanger is usually fitted on the top of the direct current machine, upon request it may also be fitted on the side (please ask SICMEMOTORI). The CBARH version is chosen when a good degree of protection is required (IP 44 or over) and the water needed is available. Type of cooling IC 86 W. Protection devices for air-water heat exchanger.

Figures e.01.2.1 and e.01.2.2 show the different solutions adopted for P-NP motors.

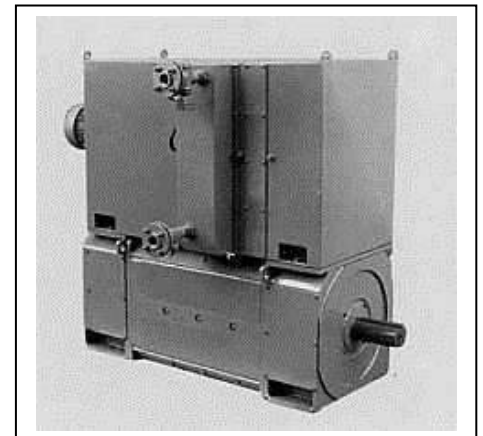
**E.01.2.1 Protection devices for air-water heat exchanger****Ventilation failure detector**

This is a differential pressure switch type LGW 10 A2 installed in the internal air circuit (SICMEMOTORI code 8.1.59.1.2.070.0). Capacity of contacts: 250 V_{ac}, 3A.

Inner air thermostat

This is a thermostat type C03A, with an adjustment range of between +10 and +90°C and differential of 1 K/min. The thermostat is complete with a switching contact with operating current of 2.5 A at 250 V_{ac} (SICMEMOTORI code 1.00.0.9.77.01).

Flow switch

This is a relay type FF81, with flexible blade dipped in the fluid to be controlled which operates the switching of a microswitch. Maximum operating pressure 10 bar. Operating current 4A at 250 V_{ac} (SICMEMOTORI code 1.00.0.9.77.02).

Water losses device

Under the cooling battery, a cup is placed to collect any eventual water loss. The device is a magnetic level sensor type ILSP S2 (SICMEMOTORI code 1.00.0.9.77.03), 250 V – 3 A.

E.01.2.2 Terminal box for air-water heat exchanger

Each heat exchanger is supplied with a terminal box (degree of protection IP54 or over), containing the terminals of the protection devices listed under E.01.2.1 and those of the asynchronous motor of the electric fan. The terminal box contains also the ventilation failure device and the inner air thermostat.

E.01.3 Air-air heat exchanger

The heat exchanger essentially comprises a cooling battery with finned aluminium pipes. The air inside the direct current machine is circulated in a closed circuit by an electric fan, and before entering the battery it passes through a removable, washable, self-extinguishing VILEDON filter (see E.01.1.1).

The cold ambient air is drawn through, from bottom to top, by another electric fan. The main specifications of the air-air heat exchangers are given in technical catalogues.

The exchanger is usually fitted on top of the direct current machine, but upon request it may also be fitted on the side (please ask SICMEMOTORI). This type of heat exchanger is chosen, despite the derating it involves in the performance of the direct current machine, when a good degree of protection is required (IP 44 or over) and water of the suitable quality and/or sufficient quantity for the air-water heat exchanger is not available. A typical instance of the use of machines in the CBARO version is that of outdoor installation in a duty or aggressive environment, when the environment temperature can fall below 0°C.

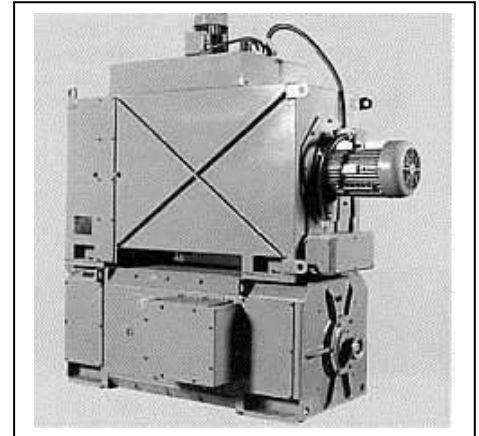
**E.01.3.1 Protection devices for air-air heat exchangers**

The standard devices specified for air-air heat exchangers are the following

Ventilation failure detector

2 devices are foreseen, one for each air circuit:

Inner air circuit: this is the differential pressure switch type LGW 10 A2 already described under E.01.2.1 (SICMEMOTORI code 8.1.59.1.2.070.0.).

Outer air circuit: this is the pressure switch HUBA 625-90-40 already described under E.01.1.2 (SICMEMOTORI code 8.1.59.1.1.006).

Inner air thermostat

A thermostat C03A is specified as described under E.01.2.1 (SICMEMOTORI code 1.00.0.9.7701).

E.01.3.2 Terminal box for air-air heat exchanger

Each heat exchanger of this type is supplied with a terminal box (degree of protection IP 54 or over) containing the terminals of the protection devices listed under E.01.3.1 and those of the asynchronous motors of the 2 electric fans.

The box also contains the inside air ventilation failure detector and the thermostat.

E.01.4 Natural convection heat exchanger

A 'channel' in welded sheet metal connects the two upper vents of the direct current machine. The release of heat to the walls of the channel is aided by inner ribbing.

The heat is transmitted from the channel to the environment air by natural convection.

The version CNVC is with degree of protection IP 44 or over.

Type of cooling IC 610.

This version, available only for sizes 132-250 may be chosen for installation in very dusty or outdoor environments.

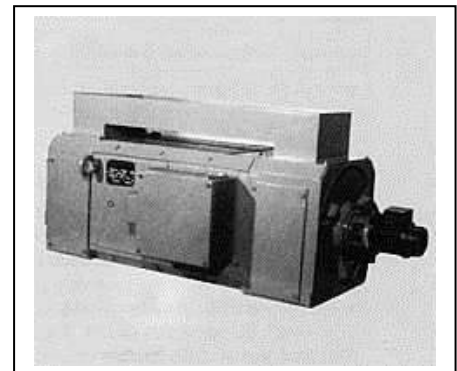

E.01.5 Noise reduction devices for machines with fitted electric fan

If lower than standard noise levels are requested (see B.22), SICMEMOTORI has developed a series of mufflers to be applied to the air inlet vent on the fan of the motor which make it possible to reduce noise to the average levels given in table e.01.5.1 (measured as mentioned in section B.21).

Motor	Noise level (dBA) With silencer on inlet air	Motor	Noise level (dBA) With silencer on inlet air
225 N	80	315	80
225 K	80	355	80
250 N	80	400	80
250 K	80	450	80
280	80	500	80

Tolerance -0 +3 dBA

Table e.01.5.1

The addition of silencers increases the overall dimensions of the motors as shown in table e.01.5.2.

Motor	C	D	Motor	C	D
225	445 x 445	500	355	906 x 630	600
250	510 x 510	500	400	806 x 640	600
280	635 x 510	500	450	920 x 820	600
315	635 x 470	500	500	1050 x 820	605

N.B. approximate, provisional dimensions in mm

Table e.01.5.2

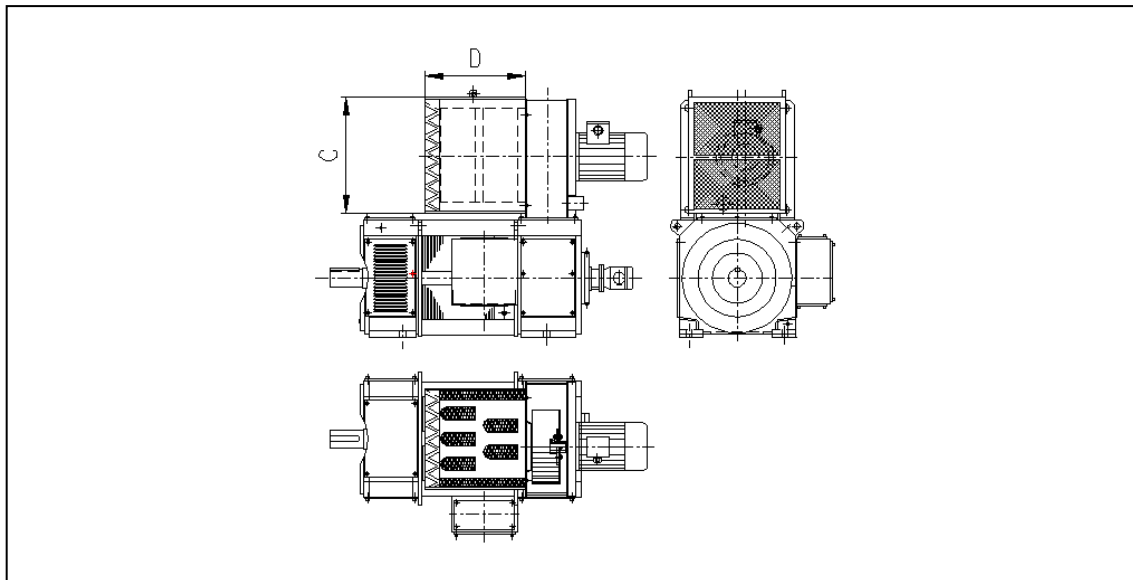

For more details please ask SICMEMOTORI.

Warning: the application of the silencer could reduce the motor output. Please always ask SICMEMOTORI.

E.01.6 Noise reduction devices for machines with fitted heat exchanger

The reduction of the noise level is more evident in machines with air-air heat exchanger, where the high level of noise is caused by the high speed of the cooling air of the outside circuit. SICMEMOTORI has developed a special type of air-air cooler with lower noise level, as shown in e.06.1 (average values measured as described in point B.21). For more details please contact SICMEMOTORI.

Motor	Noise level (dBA)		
	IC666 (CBARO) standard	IC666 (CBARO) silenced	IC86W (CBARH) standard
132 N	84	---	80
132 K	84	---	80
160 N	84	---	80
160 K	84	---	80
180 N	84	---	80
180 K	84	---	80
200 N	84	---	80
200 K	84	---	82
225 N	86	82	82
225 K	86	82	82
250 N	86	82	82
250 K	86	82	82
280 K	86	82	82
315 K	86	82	82
355 K	90	85	82
400 K	90	85	82
450 K	90	85	82
500 K	90	85	84
560 K	95	85	84

Tolerance $-0 +3$ dBA

Table e.06.1

E.02 Accessories for protection and control

E.02.1 Devices for protection against overtemperature

These are temperature sensors which are normally applied in the machine to detect the temperature of an element of the armature circuit (auxiliary poles coil), and give a signal to operate the release relays of the main contactor.

The same types of sensors can be used to detect the temperature of other points of the machine (main poles, inside air) and supply release signals or only alarm signals.

E.02.1.1 Klixon thermal protectors

These are bimetal NC contacts which open when the temperature exceeds a predetermined value and close again when it falls below the trip level by a predetermined margin. Type 9700-K-4611 is used (SICMEMOTORI Code 8.1.47.1.0.150).

All SICMEMOTORI D.C. motors are normally supplied with 1 Klixon on an auxiliary pole (sizes 80-315) or with 1 Klixon on an auxiliary pole and 1 on a main pole (sizes 355-800). Other klixons can be supplied upon request.

The main specifications of klixon 9700-K-46-11, referring to 250 V_{ac}, 50/60 Hz, are as follows:

operating current at $\cos \varphi$ 0.6	: 1.2 A
operating current at $\cos \varphi$ 1	: 2A
maximum continuous capacity	: 4A
cut-in temperature	: 150°C ($\pm 5^\circ\text{C}$)
maximum capacity of contacts	
≤ 18 A at 24 V _{dc}	
≤ 18 A at 115 V _{ac}	
≤ 13 A at 230 V _{ac}	

The klixon terminals are contained in the main terminal box of the direct current machine.

The protection is against slow overloads or insufficient ventilation.

E.02.1.2 PTC thermistors

These are elements with a positive temperature coefficient with a low resistance rating, practically constant below the set rating, which increases sharply above the set rating. Type Q-63100-P2390-C833 is used (SICMEMOTORI code 8.1.80.1.02.03). The PTCs are used upon request in place of the klixons, in the same manner.

Their main specifications are as follows:

Operating voltage	: 220/265 V
Nominal current	: 35 mA at 25°C
Cut-in current	: 50 mA at 25°C
Commutation current	: 70 mA at 25°C
Resistance	: 120 ohm at 25°C
Reference temperature	: 140° C
Tolerance	: +7% on set rating

The PTC terminals are contained in the main terminal box of the direct current machine.

For use the PTCs need a power supply (indicative consumption 3,5 VA at 24 V_{dc}), including a release relay with closed contact at rest which can break 1,5 A at 230 V_{dc} or 1,25 A at 24 V_{dc}.

This appliance must be installed in the control equipment associated with the machine and is excluded from SICMEMOTORI supply.

The protection is against fast and high overloads or insufficient ventilation.

E.02.2 Overtemperature measuring devices

These are sensors which, fitted in different points of the direct current machine, are each capable of transmitting a signal proportionate with the temperature detected, as their resistance changes linearly with the temperature itself.

E.02.2.1 Pt100 platinum thermal detectors

The sensitive elements are type 1 PT100 FKG 430.6 (SICMEMOTORI code 8.1.80.1.0070.0) and they have the following specifications:

- Range of use : 0-200°C
- precision at 0°C : ± 0,3°C
- precision at 100°C : ± 0,8°C

The two wires leading from each platinum element are taken to the main terminal box of the direct current machine. For the use of these elements a control unit is needed which powers them at stabilised voltage and is complete with an indicator calibrated in °C and switch (manual or automatic) for periodical measurement of the overtemperatures in the various points under control. The control unit is excluded from SICMEMOTORI supply. Normally only one such unit is used to monitor both the direct current machine and the coupled load.

E.02.3 Brush wear control device – CR1 system

All P-NP machines may be fitted with a system that warns when the maximum brush wear limit has been reached, so that they can be changed before any damage to the commutator. AI2 relays, supplied as part of the device and normally supplied loose (for assembling into the control box), gives a signal which can be properly utilised by the operator.

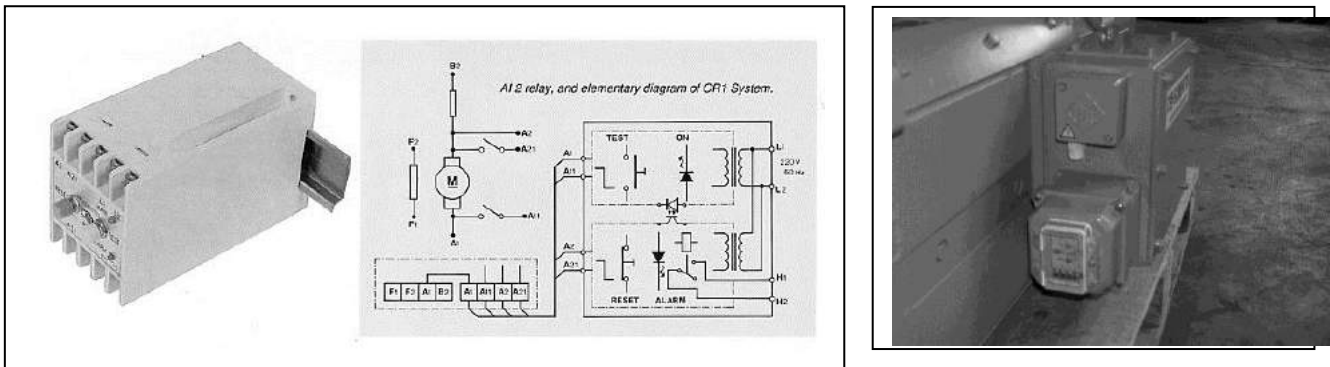

E.02.4 Overspeed switch

The centrifugal switch is normally fitted on the NDE of any direct current machine designed for operation under field weakening (speed adjustment at constant power). Its purpose is to provide 'backup' protection against excessive overspeeds, in addition to the protection already given by a current relay inserted in the excitation circuit control equipment; in fact, this relay is not very reliable when field-weakening is very heavy. Types normally foreseen and their specifications are given in table e.02.4.

Type	Operating speed (RPM)		Precision	NC contact capacity at 250 V _{ac}
	min	max		
RCOE01	800	3000	±5%	5 A
RC2	600	6300	±3%	2 A
FSL	800	5200	±3%	2 A

Table e.02.4

The cut-in speed of the centrifugal switch is set 12% higher than the maximum speed at which the direct current machine to be protected should work (unless otherwise agreed upon at the time of ordering).

The centrifugal switch is usually requested together with a tachogenerator and/or with a pulse generator (see E.03.04).

E.02.5 Bearing vibration control sensor

This is a sensor fitted in the immediate vicinity of each rolling bearing, capable of transmitting an alarm signal at the first sign of abnormal noise.

Unless particularly agreed upon, this accessory is not included in our supply; but upon request and according to precise indications, holes are drilled for their installation in correspondence with the bearing housings.

In lack of instructions, connection for this instrument is made with a suitably chamfered M8 hole

E.02.6 Bearing temperature control sensor

This is normally a PT 100 heat detector fitted in contact with the outer surface of the bearing, which detects its temperature.
The specifications of the heat detector and the control unit for its use are listed under point E.02.2.1.



E.03 Accessories for speed measurement and control

E.03.1 Tachogenerators

The tachogenerator produces a signal in continuous voltage proportionate with its speed. Normally it is fitted on the NDE of the direct current motor with the interposition of a special provision and coupling (see E.03.1.1. and E.03.1.2) or directly on the motor shaft (see E.03.1.3).

More common tachogenerators are shown in table e.03.1

Type	Voltage (1000 RPM)	I _{max} (A)	IP	Shaft diam. (mm)	Cables exit	SM code
REO 444 L1	60 V	0.1	44	11	Cable gland	8.00.09.65.L.10
REO 444 NV1	60 V	0.18	44	11	Free cables	8.00.09.65.D.20
REO 444 R1	60 V	0.18	54	11	Terminal box	8.00.09.65.D.40
REO 444 R2	2x60 V	2x0.14	54	11	Terminal box	8.6.42.11.171.0
TDP 0.2 LT	60 V	0.067	55	11	Terminal box	8.6.42.11.621.0
FRB 11/6	60 v	0.07	55	11	Terminal box	8.6.42.11.121.3

Table e.03.1

E.03.1.1 Couplings for tachogenerators

The following two coupling types are most commonly used:
- type 54.3 (SICMEMOTORI code R.1.00.0.9.31.34.2)
- type GEL-S-500 (SICMEMOTORI code R.1.00.0.9.31.79.0)
Both are made from anodised aluminium, with flexible diaphragm in sulphur-bronze.
The angular displacement allowed is 3°, while the max. axial displacement is 1 mm (type 54.3) or 8 mm (type GEL-S-500)
Upon request, for heavy or special duty, couplings with different specifications can be supplied, as agreed at the time of defining the order.

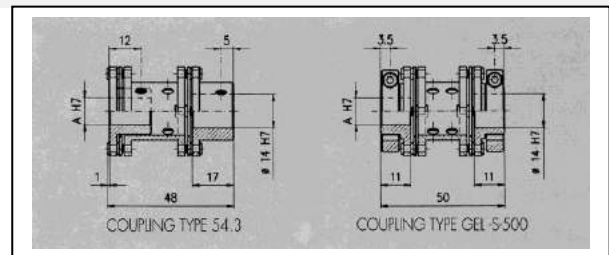

E.03.1.2 Provisions for tachogenerators

The tachogenerator is connected to the motor through a die-cast aluminium spider. Side drawing shows simplifications of how it is fitted

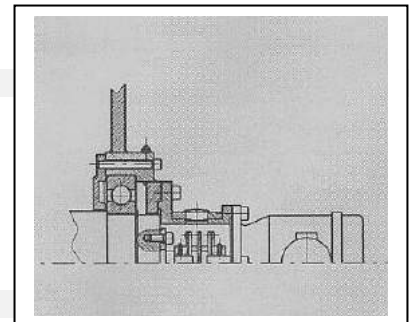

E.03.1.3 Hollow shaft tachogenerators

In this case the tachogenerator is assembled directly on a stub-shaft made especially at the non-drive end of the direct current motor, with no need for a coupling or spider. The tachogenerators more commonly used are shown in table e.03.1.3.1.
Figure e.03.1.3.2 shows how they are fitted

Type	Voltage (1000 RPM)	I _{max} (A)	IP	Cable exit	SM code
RDC 215	60 V	0.059	44	Cable gland	8.00.09.65.D.60
RDC 215	20 V	0.170	44	Cable gland	8.00.09.65.D.50
BRB 11/6	60 V	0.07	54	Term. box	8.6.42.19.121.3
BRB 11/2	20 V	0.2	54	Term. box	8.6.42.10.111.3

e.03.1.3.1

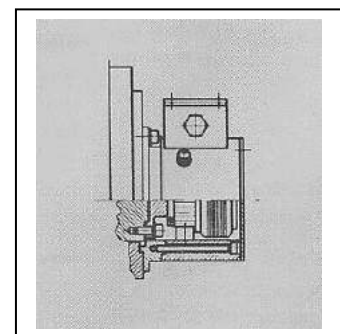

e.03.1.3.2

E.03.2 Pulse generators

The pulse generator (encoder) emits a series of pulses with frequency proportionate with the speed of the direct current motor to which it is coupled. The pulse generator is usually used for extremely precise control of the speed linked with the use of modern digital control systems.

The pulse generator is fitted on the direct current motor in the same way as the tachogenerator.

Main characteristics of the standard model are shown in table e.03.2.1.

Channels	PPR	Electronic	Vdc in-out	Hollow shaft
A,/A;B,/B;Z,/Z	1024 (*)	Line Driver	5	15 mm
A,/A;B,/B;Z,/Z	1024 (*)	Line Driver	11/30	15 mm

(*) other PPR (Pulses Per Revolution) available on request Table e.03.2.1

It is also possible to get these encoders with same mounting characteristics than tachogenerators type RDC215 (see E.03.1), with hollow shaft.

Other types can be assembled on request. Most common pulse generators types are shown in table.03.2.2.

Brand	Type	Provision
Stegmann	DGS-66	Hollow shaft
Hohner	GHT 51	Hollow shaft
Radio-Energie	RCO058	Hollow shaft
Hubner	POG9	Hollow shaft
Hengstler	RI58TD	Hollow shaft
Tekel	TI58HS	Hollow shaft
Tekel	TK	Coupling
Elcis	115T	Coupling

Table e.03.2.2

For exact definition of the pulse generator the following must be stated when inquiring:

- number of pulses per revolution
- powering voltage
- output voltage
- number of channels
- presence of zero pulse or not
- type of electronic
- bi-directional or not
- type of connector (connector or cable box or free cables)

If the pulse generator is not included in those listed in table e.03.2.2, it is necessary to supply its drawing to SICMEMOTORI technical department, to design its assembly on the D.C. motor.

E.03.3 Overspeed switch

Please refer to point E.02.4.

E.03.4 Integrated units for speed measurement and control

In modern systems demands increasingly include combinations of tachogenerators (Tacho) with pulse generators (PG) and overspeed switches (Overp. switch).

The more common available combinations are shown in table e.03.4. Other combinations are available on request.

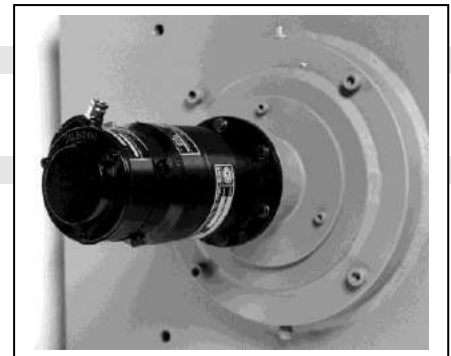

Tacho + Overspeed switch	Tacho + PG	Tacho + PG+ Overspeed switch	PG + Overspeed switch
TDP 0.2 LT + FSL	TDP 0.2 LT + OG9	TDP 0.2 LT + OG9 + FSL	POG9 + FSL
REO444R1 + RCOE01R	REO444R1 + RCO058R	REO444R1 + RCO058R + RCOE01R	RCO058R+RCOE01R
REO444R1 + RC2	REO444R1 + 115T	REO444R1 + 115T + RC2	

Table e.03.4

E.04 Other accessories

E.04.1 Anticondensation heaters

The use of anticondensation heaters is recommended and specified for machines installed in environments with high levels of difference in temperature, or for closed machines, where the danger of the formation of condensate water exists, that could cause loss of insulation of the actual machines.

The heaters must be set to work only with the machine stopped, and they must be disconnected when it is started.

The NP machines frames 225-800 with air-water and air-air heat exchangers are always supplied with anticondensation heaters.

The heater terminals are located in an auxiliary terminal box, separated from the direct current machine main terminal box.

Table e.04.1 shows the specifications of standard heaters.

Different power supplies are available upon request when ordering

Motor size	Supply	Quantity and power (W) for closed machines	Quantity and power (W) for open machines
90	220 V single-phase	1 x 50 W	1 x 100 W
100	220 V single-phase	1 x 50 W	1 x 100 W
112	220 V single-phase	1 x 50 W	1 x 100 W
132	220 V single-phase	1 x 100 W	1 x 150 W
160	220 V single-phase	1 x 100 W	1 x 150 W
180	220 V single-phase	1 x 100 W	1 x 150 W
200	220 V single-phase	1 x 150 W	1 x 200 W
225	220 V single-phase	1 x 200 W	2 x 200 W
250	220 V single-phase	1 x 200 W	2 x 200 W
280	220 V single-phase	1 x 300 W	2 x 300 W
315	220 V single-phase	1 x 300 W	2 x 300 W
355	380 V three-phase	1 x 300 W	2 x 400 W
400	380 V three-phase	1 x 400 W	2 x 400 W
450 RS-S	380 V three-phase	1 x 400 W	2 x 400 W
450 SM-X	380 V three-phase	1 x 500 W	2 x 500 W
500 RS-S	380 V three-phase	1 x 500 W	2 x 500 W
500 SM-X	380 V three-phase	1 x 500 W	2 x 500 W
560 RS-S	380 V three-phase	1 x 500 W	2 x 500 W
560 SM-X	380 V three-phase	1 x 500 W	2 x 500 W
630 RS-S	380 V three-phase	1 x 500 W	2 x 500 W
630 SM-X	380 V three-phase	2 x 400 W	2 x 500 W
710 RS-S	380 V three-phase	1 x 500 W	2 x 500 W
710 SM-X	380 V three-phase	1 x 800 W	2 x 800 W
800 RS-S	380 V three-phase	1 x 800 W	2 x 800 W
800 SM-X	380 V three-phase	1 x 800 W	2 x 800 W

Table e.04.1

E.04.2 Transparent brushes inspection doors

On request, machines size 90-315 may be provided with transparent brushes inspection doors which simplify checking the commutation and the conditions of commutator and brushes.

The material used is polycarbonate, with chloroprene seals. For sizes 355-800 transparent doors are a standard feature.

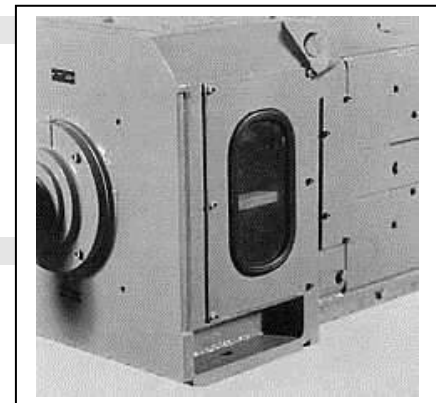

E.04.3 Rotor earth brushes

On request, it is possible to install a brush for earthing the rotor, which is helpful in preventing Eddy currents from passing through the bearings of the direct current machine, there by eliminating the risk of possible damage to the bearings themselves and to the small bearings of the accessories.

E.04.4 Anchorage and foundation devices

Upon request it is possible to supply the anchors or foundation plates needed for fastening the direct current machine (for direct coupling) directly in the bed and/or concrete. Table e.04.4 gives the recommended dimensions (mm) for frames 225-450. For other frames please ask SICMEMOTORI.

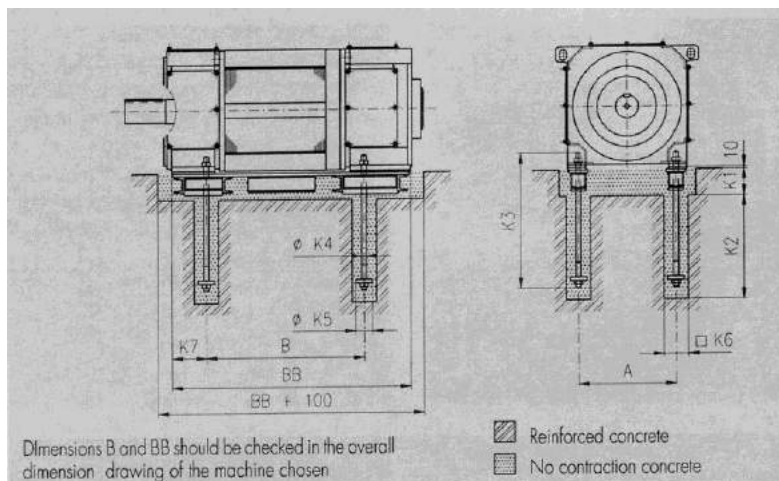

e.04.4

Motor	A	K1	K2	K3	K4	K5	K6	K7
225	356	150	---	---	---	---	---	125
250	406	150	---	---	---	---	---	144
280	457	200	---	---	---	---	---	166
315	508	200	---	---	---	---	---	192
355	610	250	650	900	30	120	160	224
400	686	250	650	900	30	120	160	250
450	800	250	650	900	30	120	160	285

Table e.04.4

E.04.5 Brakes

Upon request it is possible to supply either electromagnetic or air brakes, fitted on both the second power shaft end and on the main end of the direct current machine.

To define the type of brake suited to the application the braking data: manoeuvres/hour, inertia of the masses to be braked, type of brake (parking, emergency) etc. need to be known.

For motors frames 90-180, SICMEMOTORI has normalized NIA/NFF type brakes, as shown in Table e.04.5.1a and e.04.5.1b

Motor frame	Brake frame			
	PVA (and derived) executions		CNV execution	
	Parking or working (Tb ≤ Tn)	Emergency (Tb ≥ 1,5 Tn)	Parking or working (Tb ≤ Tn)	Emergency (Tb ≥ 1,5 Tn)
NP 90 NR	NIA 2	NIA 4	NIA 2	NIA 2
NP 90 NS2	NIA 2	NIA 4	NIA 2	NIA 2
NP 90 NM2	NIA 4	NIA 4-6.3	NIA 2	NIA 2
NP 90 NL2	NIA 4	NIA 6.3	NIA 2	NIA 2
NP 100 NR2	NIA 4	NIA 6.3	NIA 2	NIA 2
NP 100 NS2	NIA 4	NIA 6.3	NIA 2	NIA 2
NP 100 NM2	NIA 6.3	NIA 10	NIA 2	NIA 4
NP 100 NL2	NIA 6.3	NIA 10	NIA 2	NIA 4

Table e.04.5.1a

Motor type	Brake frame		
	Parking (Tb ≥ 1/3 Tn)	Working (Tb ≤ Tn)	Emergency (Tb ≥ 1.5 Tn)
P 112 NS 2	NIA 4	NIA 6.3	NIA 10
P 112 NM 2	NIA 4	NIA 6.3	NIA 10
P 112 NL2	NIA 4	NIA 10	NIA 16
P 132 NS 2	NIA 6.3	NIA 10	NIA 16
P 132 NM 2	NIA 6.3	NIA 16	NIA 16
P 132 NL 2	NIA 6.3	NIA 16	NIA 25
P 132 NX 2	NIA 6.3	NIA 16	NIA 25
P 160 NS 2	NIA 10	NIA 25	NIA 40
P 160 NM 2	NIA 10	NIA 25	NIA 40
P 160 NL 2	NIA 10	NIA 40	NIA 63
P 160 NX 2	NIA 16	NIA 40	NIA 63
P 180 NS 4	NIA 16	NIA 40	NIA 63
P 180 NM 4	NIA 16	NIA 40	NIA 63
P 180 NL 4	NIA 25	NIA 63	NFF 100
P 180 NX 4	NIA 25	NIA 63	NFF 100

Table e.04.5.1b

- Notes: a) numbers defining the type of brakes correspond to the dynamic braking torque of the brake in DaNm
 b) brakes shown in above table are referred to motors with maximum performances; in case of derated motors, smaller brakes can be assembled. Please ask SICMEMOTORI.

NIA brakes are disk brakes, with braking torque generating by springs and with electromagnet for its release. These brakes can work in a dusty environment too, but without oil; they have degree of protection IP60 (IP65 for the electric circuits), when the brake is coupled to the motor. Standard brakes are for horizontal mounting only in case of vertical mounting, it is necessary to specify that when ordering.

Table e.04.5.2 shows main electrical and mechanical characteristics of standard brakes.



Brake type	NIA 2	NIA 4	NIA 6.3	NIA 10	NIA 16	NIA 25	NIA 40	NIA 63	NFF 100
Braking torque Nm	20	40	63	100	160	250	400	630	1000
Supply voltage	24 Vdc	24 Vdc	24 Vdc	24 Vdc	24 Vdc	24 Vdc	24 Vdc	24 Vdc	110 Vdc
Power W	80	67	103	110	124	149	170	249	270
Current A	3,34	2,81	4,28	4,57	5,18	6,2	7,1	10,4	2,46
Weight kg	5,5	7,3	8,6	10,9	14,4	21	34	44,5	70
Inertia kgm ²	0,0004	0,00043	0,00073	0,00128	0,00135	0,00325	0,00775	0,01375	0,02575

Table e.04.5.2

Brakes with degree of protection IP55 or over, with hand release, microswitch for open brake, anticondensation heaters, etc., for specific applications (i.e. cranes) are available. Please ask SICMEMOTORI.
 In case of repeated brakings, please ask SICMEMOTORI Technical Dept. to define the right bake frame.

E.04.6 Belt tensioner slide-rails

To facilitate coupling by belts, it is possible to supply the P-NP machines complete with belt tensioner slide rails.
 The supply includes the cast iron slide with tensioner screws and tension plate. For details please ask SICMEMOTORI.

E.04.7 Bed-plates

On request SICMEMOTORI can offer and supply self-supporting or non self-supporting bed-plates, in particular for tandem or triple motors. In such case, SICMEMOTORI can also offer and supply: couplings (toothed or electromagnetic), foundation bolts, coupling guard, set for assembling the tachogenerators with pulley and belt, brakes, etc.. Motors are always coupled and aligned on the basement, and then delivered loosed.
 SICMEMOTORI can supply also, on request, the engineering of the basement, leaving its manufacturing to the customer. Please ask SICMEMOTORI.

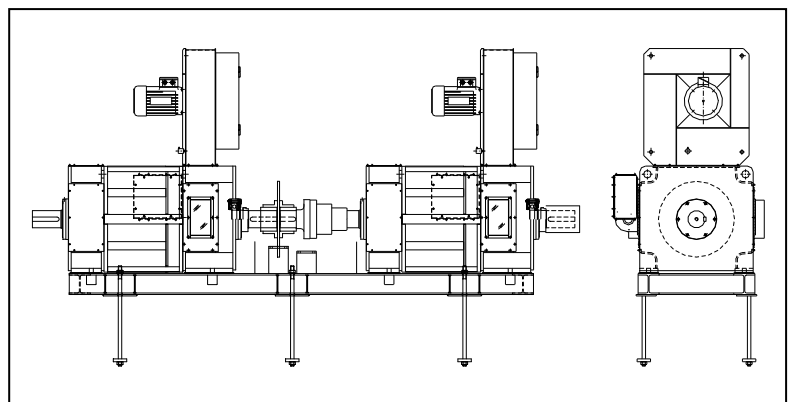
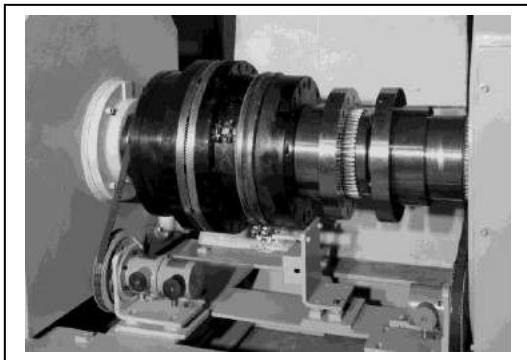
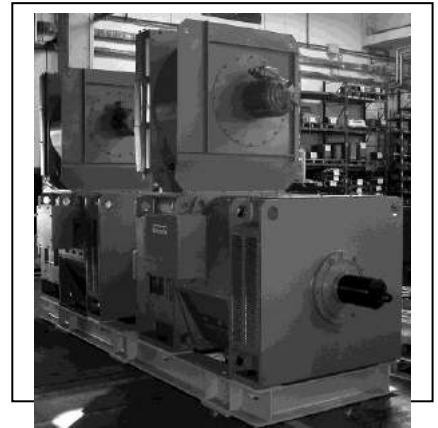

E.04.8 Gearboxes

On request SICMEMOTORI can offer and supply D.C. gearbox motors. P-NP motors can be directly coupled with gearbox if:
 - gearbox and motor flanges are identical
 - motor shaft is compatible with pinion gear (length and diameter)
 Oil seal must be assured by the gearbox. Be careful that gearbox does not transmit axial or radial thrusts to the motor.
 Perpendicularity and concentricity are according to IEC 72 Standards, Class N. On request, class S is available (surcharge). Table e.04.8 shows admissible values.
 If requested, SICMEMOTORI can supply the complete motor + gearbox or can take in charge only the assembly of the D.C. motor to the gearbox (free-issued supply).

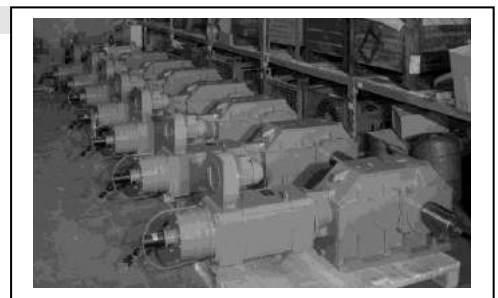

Centering diameter N (mm)	CLASS N Deviation in micron		CLASS S Deviation in micron	
	Perpendicularity	Concentricity	Perpendicularity	Concentricity
From 40 to 100	80	80	40	40
> 100 to 230	100	100	50	50
> 230 to 450	125	125	63	63
> 450 to 800	160	160	80	80
> 800 to 1250	200	200	100	100

Table e.04.8

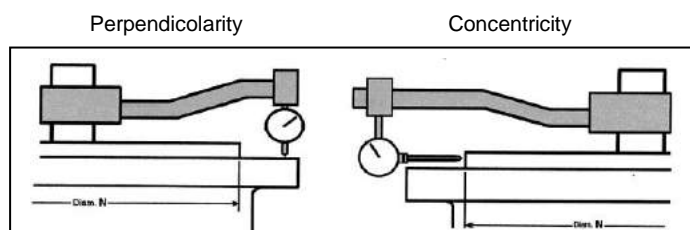

F. COMMERCIAL INFORMATION**F.01 Offers**

Except different notice, our offers are valid 30 days from date of issue.

F.02 General Terms of Supply

The general terms of supply are an integral part of all our offers and order confirmations. Any special supply clauses should be agreed upon individually with the Customer when ordering, which delete and replace only the corresponding clauses of the General Terms of Supply, leaving all the others valid. The General Terms of Supply are available on request and are printed on the back of all order confirmations.

General

- The general sales conditions listed herein are to be considered valid for any order made to SICMEMOTORI and are an essential part of each order. Any derogative clauses or special supply conditions must be expressly stated in the text of the SICMEMOTORI Order Confirmation or otherwise agreed in writing. The issue by the Customer of an order to SICMEMOTORI and the subsequent receipt of SICMEMOTORI Order Confirmation involves, amongst other things, the acceptance of the present general sale conditions and every other specific conditions stated on the Order Confirmation.
- Any behaviour, also of repetitive nature, by either of the two parties which does not coincide with one or more of the present conditions will not in any way jeopardise the right of the other party to request their application at any time.

Manufacturer liability

- SICMEMOTORI, in its capacity as manufacturer of the goods supplied to the Customer, is responsible for damages attributed to defective products in accordance with Italian Law DPR 224 of 25 May 1988.
- The Customer is aware that all products manufactured by SICMEMOTORI are designed exclusively for installation and operation in industrial environments, by technical personnel who are sufficiently experienced and made aware of the potential hazards which may derive from the improper use of rotating electrical machines.
- For this purpose, the Customer undertakes to provide the operators assigned to the installation and operation of SICMEMOTORI products, the booklet containing the Installation, Operation and Maintenance Instructions, supplied by SICMEMOTORI with the product, and to ensure the observance of the prescriptions contained in it. The Customer will undertake the same obligations in the event of transfer of SICME MOTORI products to third parties.
- The responsibility for defective products is excluded in all cases covered by article 6 of Italian Law DPR 224/1988. SICMEMOTORI shall have no obligation to provide compensation for indirect or abstract damages such as, without limitation, lost of production, lost of earnings, lost invoicing, costs linked to production stoppage, etc. In any case SICMEMOTORI declines all responsibility in case of tampering with its products, or defects due to repairs or operations by third parties who have not been explicitly authorised.

Orders and order confirmations

Orders forwarded by the Customer to SICMEMOTORI shall be deemed to be accepted only if confirmed in writing by SICMEMOTORI (order confirmation forwarded by post, fax or e-mail). The text of the order confirmation shall in any case prevail over any other conditions or clauses contained in the Customer's order and will remain the sole document with contractual validity, unless otherwise stated by the Customer, which must reach SICMEMOTORI within fifteen days of receipt of the order confirmation.

Delivery terms

The delivery terms are those stated on the order confirmation, which must be considered as an indication of the date upon which the product will be available. SICMEMOTORI is therefore exonerated from all responsibility for confirmed damages due to delivery delays.

Risk transfer

The products shall be delivered and sold ex SICMEMOTORI works in Turin, Italy. Should the goods be sold free at destination, following explicit agreement stated in the order confirmation, the transfer of risk from SICMEMOTORI to the customer shall take place upon departure of the products from the SICMEMOTORI plant.

Payment terms

Unless otherwise agreed, payment shall be made upon delivery of the goods. The prices indicated shall be net of all expense, discount or tax. The Customer is bound to pay the price at the moment the goods become available for pick up. Omitted or late payment according to the specified terms shall cause the immediate imposition of interest to be charged at a current annual bank rate, as well as the withdrawal of the Customer's benefit of such term for all future orders, and shall entitle SICMEMOTORI to demand immediate payment or to consider suspended or cancelled the fulfilment of all other pending orders.

Warranty

SICMEMOTORI guarantees its products for 12 months from the date of delivery. The warrantee covers exclusively manufacturing defects ascribable to SICMEMOTORI, who may decide to repair or replace the product or the part deemed defective, as seen fit. The cost and risk involved in transporting the product from the Customer to SICMEMOTORI shall be borne by the former. The warranty is automatically voided in case of tampering or unauthorised interventions, and does not extend to parts normally subject to wear (e.g.: bearings, brushes, filters).

The warranty is also voided in case of failure to comply with the prescriptions contained in our Installation, Operation and Maintenance Instructions, available to the Customer on request, an excerpt of which is enclosed inside the terminal boxes of all machines supplied by SICMEMOTORI.

If a part is replaced or repaired, the warranty shall be renewed solely for that piece. The Customer may not withhold payment on the grounds that the warranty does not meet his satisfaction. In all cases the warranty is voided if the Customer fails to comply with that indicated in subsection 1 of article 1495 of the Civil Code. **Warranty and sales support are regulated by instructions given by SICMEMOTORI ISO9001-2000 Quality System.**

Applicable law and jurisdiction

- The contract of which these general conditions are an integrated part is governed by current Italian laws.
- Any controversy that should arise between the parties regarding the contracts of which these general conditions are an integrated part shall be heard before Turin Court.

F.03 Guide sheet for requests for quotations and orders transmission

The following page shows a reproduction of form CT.01 used as a guide for completing the technical part of requests for quotation (which must also be used when sending the order).

Copies of this sheet are available c/o SICMEMOTORI sales organisation.

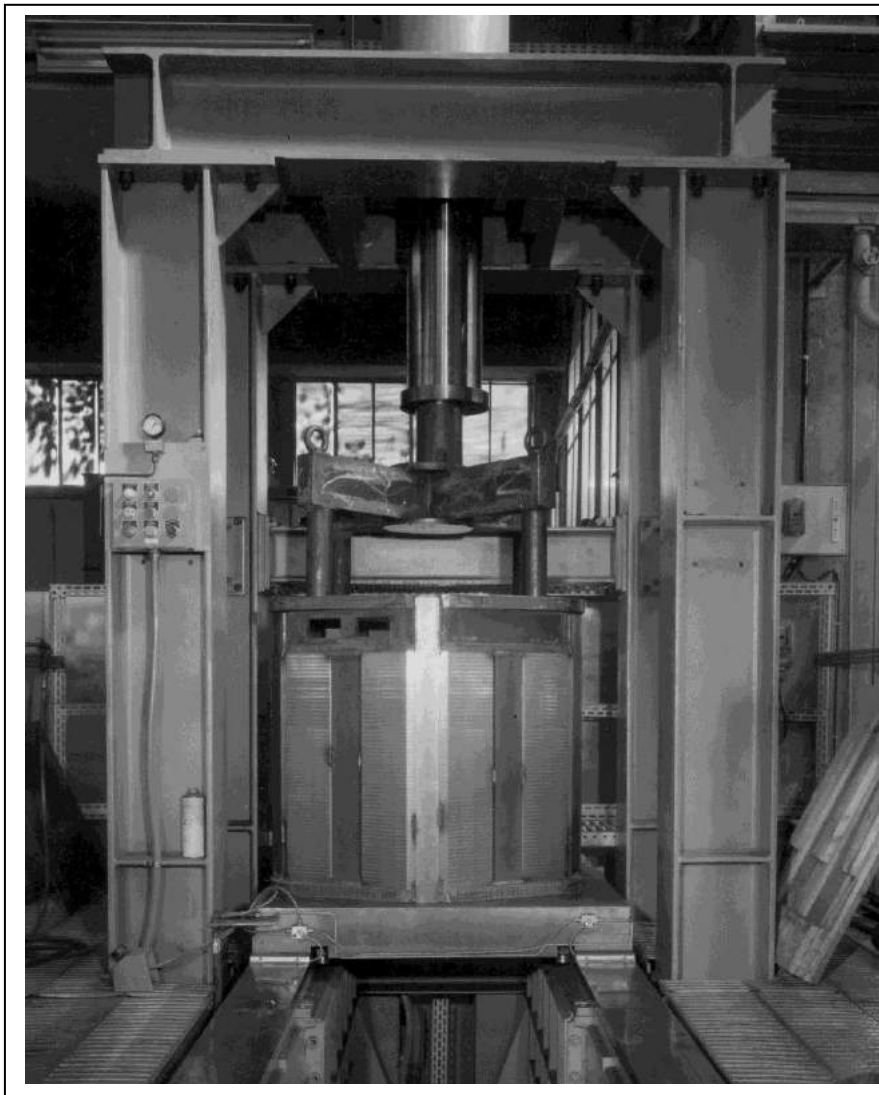



D.C. ELECTRIC MACHINE

Sicme Motori SpA

Strada del Francese 126/130 – 10156 Torino – Italy

Tel. +39-011-4076311 – Fax +39-011-4500047

sicmemotori@sicmemotori.com – www.sicmemotori.com

Offer/Inquiry No.

Item

Date

Page

Customer

Type of installation:

d.c. motor d.c. generator

Operated machine:

type Q.ty

Power	-	-	-	kW	Max. loads: continuous	%	
Speed	-	-	-	rpm	Frequent	% base speed	% max speed
Armature V	-	-	-	V	Occasional	% base speed	% max speed
Armature I	-	-	-	A			
Field V				V	<input type="checkbox"/> Compensating windings		

Method of cooling	IC06 (PVA)	IC16 (BPVA)	IC17 (BCA)	IC01 (PV)
	IC410 (CNV)	IC610 (CNVC)	IC37 (CBA)	IC36 (BPVAB)
	IC666 (CBARO)	IC86W (CBARH)		

Mounting arrangement	IM1001 (B3)	IM2001 (B35)	IM3011 (V1)	IM3001 (B5)
	IM 1011 (V5)	IM2031 (V36)	IM3031 (V3)	

Standard features

- 3-phase fully controlled bridge supply
- Insulation and temp. rise class H
- Degree of protection IP23
- Duty type S1
- Ambient temperature -15 to +40°C
- Indoor environment, no dust, neutral
- Relative humidity <= 70%
- Max altitude 1000 m.a.s.l.
- Max load 2 In for 15" every 5' or for 1' every 20'
- Separate excitation
- Mounting arrangement IM1001 (B3)
- Standard shaft end
- Direct coupling or toothed belt coupling
- DE ball bearing (<=200) or roller bearing (=>225)
- Balancing N degree, with half key
- Terminal box right side DE view (on top <=112)
- Blower on top, commutator side, with filter
- Painting cycle 1, final colour RAL6011 (green)
- Noise level according to IEC 34-9
- IEC 60034-1 Standards

Modifications

- Supply Ward-Leonard
- Temp. Rise Cl. F (105°C) Cl. B (80°C)
- Degree of protection IP44 IP55
- Duty cycle
- Ambient temperature°C max°C min
- Environment external under roof humid-salty
- chemical agent (type
- other
- Altitude m. a.s.l. Relative humidity%
- Max load Nema cold Nema hot
- Excitation Derivate Compound
- Special shaft dim. keywayed keyless
- Special flange dim.
- Belt drive type
- pulley diameter mm pulley width mm
- DE roller bearing (<=200)
- Balancing R degree S degree
- Second power shaft end – dimensions xmm
- Terminal box left DE view on top
- Blower position
- Air inlet on top DE NDE
- Painting cycle Final colour RAL.....
- Tropicalization Noise level dBA
- Special Standards

If other datas are not specified, the above will be assured

Accessories for cooling

- Filter as standard Fan 3x400V – 50 Hz V Hz
- Ventilation failure detector Noise reduction system

Accessories for protection and control

- 1 klixon as standard (1+1 frames =>355)
- klixon PTC thermistors Pt100 Q.ty on main poles Q.ty on auxiliary poles
- Brush wear control device (CR1 system) Bearing vibration control sensor Bearing temperature control sensor

Accessories for speed measurement and control

- Tachogenerator/encoder type Provision only Supply
- Overspeed switch type Setting speed rpm

Other accessories

- Anticond. heater V ... Hz single-phase three-phase
- Transparent inspection doors (<=315) Earthing rotor brush
- Gearbox type gear ratio
- Electromagnetic brake type Braking torque Nm
- Other

Unit net price

Delivery time

CT.01



G. PERFORMANCE TABLES AND OVERALL DIMENSIONS DRAWINGS

Performance tables and overall dimensions drawings are shown in specific Technical Catalogues (see INTRODUCTION). Overall dimensions drawings are also available on our web site www.sicmemotori.com, and they can be easily downloaded. In any case, definitive and certified drawings can be supplied on request, also in electronic format; please ask SICMEMOTORI.

G.01 Conditions of validity

Performance tables, dimensions drawings and all technical information given by SICMEMOTORI in this General catalogue and in all Technical Catalogues are for reference only and can be changed at any moment without prior notice.



APPENDIX**1. TORQUE TRANSMISSION**

- 1.a General description
- 1.b Shaft
- 1.c Nominal torque
- 1.d Classification of types of load
- 1.e Normal keywayed shaft ends
- 1.f Cylindrical keyless shaft ends
- 1.g Pulley coupling – Maximum admissible radial loads
- 1.h Special bearings for direct coupling

2. INFORMATION ON DUTY CYCLES**3. D.C. MOTORS FOR SOME TYPICAL INDUSTRIAL APPLICATION**

- 3.a Motors for plastic and rubber industries
- 3.b Motors for metal industries
- 3.c Motors for cranes and hoisting equipments
- 3.d Motors for mining industries
- 3.e Motors for skylift and cableways
- 3.f Motors for paper and print industries
- 3.g Motors for food industries
- 3.h Motors for cement factories

4. SOME NOTE ABOUT D.C. MOTORS

- 4.a General features
- 4.b Stator and stator windings structures
- 4.c Rotor structure
- 4.d Brushes
- 4.e General operating principles and main formulas
- 4.f Speed adjustment
- 4.g Notes about D.C. generators

5. SOME USEFUL FORMULAS**6. CONVERSION TABLES****7. LOW VOLTAGE INDUSTRIAL ELECTRICITY SUPPLY IN SOME COUNTRIES**

1. TORQUE TRANSMISSION

1.a General description

During the transmission of torque between the electric machine and the coupled load the most highly stressed parts to be checked are:

- a** – the shaft if the load is solidly coupled (stress due to twisting torque);
- b** – the shaft and coupling end bearing, if coupling is indirect, through pulleys and belts or corresponding systems (stress due to radial load F_r);
- c** – the NDE ball bearing if, due to the type of assembly (vertical axis) and/or coupling, the shaft transfers more than slight axial loads (stress due to axial load F_a).

Case **a** will be examined in paragraphs 1g, case **b** has been examined in paragraphs B.19; case **c** is examined in the following paragraphs.

1.b Shaft

As described in paragraph B.15, the shaft is normally in carbon steel.

The heavier or lighter load classification can limit transmittable nominal torque to lower ratings than those available from the electromagnetic point of view; in this case the order should include one (or both) of the following provisions:

- 1 – use of special steel shaft
- 2 – a higher shaft diameter

For particularly heavy loads it is necessary to change from the keywayed shaft to a keyless cylindrical shaft on which the half coupling should be a hot-shrink interference fit.

In this case too, it can happen that the transmittable torque is below the torque available from the electromagnetic point of view and the order should include one of the following provisions:

- 1 – increased length of the shaft end (passing from the short series to the long series);
- 2 – use of special steel shaft;
- 3 – specification of a higher diameter. Tables 1b give the standard and maximum diameters of the keywayed shaft ends of the motors produced by SICMEMOTORI.

Shaft end		MOTOR SIZE									
		80	90	100	112	132	160	180	200	225	250
Standard diam. keywayed shaft	DE	24j6	28j6	28j6	38k6	38k6	48k6	55m6	65m6	85m6	95m6
	NDE	---	24j6	28j6	28j6	38k6	42k6	48m6	65m6	70m6	85m6
Maximum diam. keywayed shaft	DE	24j6	28j6	28j6	42k6	48k6	55m6	60m6	70m6	90f6	100f6
	NDE	---	24j6	28j6	28j6	38k6	42k6	48m6	70m6	75f6	90f6
Standard diam. keyless shaft	DE	---	---	---	---	38s6	48t6	55t6	65t6	85u6	95u6
	NDE	---	---	---	---	38s6	42t6	48t6	65t6	70t6	85u6
Maximum diam. keyless shaft	DE	---	---	---	---	48s6	55t6	60t6	70t6	88u6	98u6
	NDE	---	---	---	---	38s6	42t6	48t6	70t6	73t6	88u6

Shaft end		MOTOR SIZE									
		280	315	355	400	450 KRS-KS	450 KSM-KX	500 KRS-KS	500 KSM-KX	560 KRS-KS	560 KSM-KX
Standard diam. keywayed shaft	DE	95m6	100m6	110m6	130m6	140m6	150m6	160m6	170m6	170m6	180m6
	NDE	85m6	100m6	110m6	130m6	140m6	150m6	160m6	170m6	170m6	180m6
Maximum diam. keywayed shaft	DE	100f6	105f6	117m6	136m6	145m6	155m6	165m6	175m6	175m6	185m6
	NDE	90f6	105f6	117m6	136m6	145m6	155m6	165m6	175m6	175m6	185m6
Standard diam. keyless shaft	DE	95u6	100u6	110u6	130u6	140u6	150u6	160u6	170u6	170u6	180u6
	NDE	85u6	100u6	110u6	130u6	140u6	150u6	160u6	170u6	170u6	180u6
Maximum diam. keyless shaft	DE	98u6	103u6	117u6	136u6	145u6	155u6	165u6	175u6	175u6	185u6
	NDE	88u6	103u6	117u6	136u6	145u6	155u6	165u6	175u6	175u6	185u6



Shaft end		MOTOR SIZE							
		630 KRS-KS	630 KSM-KX	710 KRS-KR	710 KS-KM	710 KML-KX	800 KRS-KR	800 KS-KM	800 KML-KX
Standard diam. keywayed shaft	DE NDE	---	---	---	---	---	---	---	---
Maximum diam. keywayed shaft	DE NDE	---	---	---	---	---	---	---	---
Standard diam. keyless shaft	DE NDE *	180 180 +0,250 +0,225	200 200 +0,305 +0,275	200 200 +0,305 +0,275	220 220 +0,305 +0,275	240 240 +0,305 +0,275	220 220 +0,305 +0,275	240 240 +0,305 +0,275	260 260 +0,347 +0,315
Maximum diam. keyless shaft	DE NDE *	210 185 +0,250 +0,225	210 185 +0,305 +0,275	240 240 +0,305 +0,275	240 240 +0,305 +0,275	250 250 +0,305 +0,275	290 260 +0,305 +0,275	290 260 +0,305 +0,275	290 260 +0,347 +0,315

* shaft tolerance

Tables 1b

1.c Nominal torque

The nominal torque T_n is the torque corresponding to the nominal or data plate power rating P and to the base speed n , remembering that P represents power yielded to the motor shaft in duty $S1$. Therefore, if the data plate power is for a duty other than $S1$, the valid value for $S1$ must be obtained (in case of doubt, please ask SICMEMOTORI).

For a given P (in $S1$) and n , the nominal torque T_n is obtained by the following formula:

$$T_n = 9555,2 \times P / n$$

Where:

T_n is expressed in Nm

P is expressed in kW

n is expressed in rpm

1.d Classification of types of load

This classification concerns the driven load coupled to the direct current machine and it is made with reference to the transmittable torque and thus to the sizing of the motor shaft.

A partly different classification should be considered in order to assess the electromagnetic and/or thermal sizing of the direct current machine (see section C of this general catalogue).

For the classification criteria and typical examples of driven machines, refer to table 1d, which shows the co-relation between type of load and actuation. The definitions of the three types of loads considered for sizing the shaft are given below.

Uniform or light load

The load requires a practically constant torque over the time, with slight overloads and no mechanical shocks or fatigue stresses. The shaft of the D.C. machine is consequently sized, with adequate safety coefficients, for mechanical loads with:

- maximum running torque $< 1,6 T_n$
- starting or instantaneous loads $< 2 T_n$

Specifications of IEC Std. 60034-1 and NEMA Std. MG 1.23.41 for general industrial use are valid. The shaft end is sized for much higher transmittable torques.

Medium load

The load is considered as 'medium' when it induces continual pulsing fatigue stresses and moderate shocks to the D.C. machine shaft. The shaft of the D.C. machine is sized, with adequate safety coefficients, for mechanical loads with:

- maximum running torque $< 2 T_n$
- starting or instantaneous loads $< 2,5 T_n$

Specifications of IEC Std. 60034-1 (except the maximum torque rating) and NEMA Std. MG 1.23.41 for cold siderurgical plants are valid. The shaft end is sized for much higher transmittable torques.

Heavy load

In that case the load induces continual fatigue stresses alternated with heavy mechanical shocks to the D.C. machine shaft. The shaft of the D.C. machine is consequently sized, with adequate safety coefficients, for mechanical loads with:

- maximum running torque $< 2 T_n$
- starting or instantaneous loads $< 3 T_n$

Specifications of IEC Std. 60034-1 (except the maximum torque rating) and NEMA Std. MG 1.23.41 for hot siderurgical plants are valid. The shaft end is sized for much higher transmittable torques

Type of correlation between type of load and actuation	
Type of load	Actuation
<i>Uniform or light loads</i>	Centrifugal fans Centrifugal pumps Gear pumps Fluid stirring devices Centrifugal compressors Conveyor belts Electric generators Test benches Elevators for goods and persons Spindle motors Spinning machines Paper mill winders
<i>Medium loads</i>	Cold rolling mills (reversible and non-reversible) Finishing stands Reels Extruders Gantry cranes Hoist, gantry and trolley controls for cranes Calenders for rubber and paper Multi-cylinder reciprocating compressors Ship propulsion Hoists for mine skips Centrifuges for sugar Treatment lines: galvanizing, tining, heat treatment, etc. Rotating kilns for cement Cable lift systems Skin-pass Pinch rolls Presses Drawbenches
<i>Heavy loads</i>	'Sendzimir' rolling mills 'Pilgrim' rolling mills Hot rolling mills (reversing and non-reversing) Roughing rolls Hot strip, rod and section mills Hot wire mills Reversing roller tables Pay-off and coiler stands for hot rolling mills Crushers Start-stop shears Generators actuated by piston thermal motors Compressors with single cylinder reciprocating pumps Rotary ball or hammer mills Paper grinders 'Banbury' mixers Vibrating conveyors Traction motors Drills for oil derricks Straighteners Drum-tumblers for tanneries

Table 1d

1.e Normal keyed shaft ends

Nominal transmittable torques T_n for each type of load, and for quality of steel of the shaft:

N : normal steel C43

S : special steel 39NiCrMo3 according to UNI 7845 or Euronorm 83, with $R_p 0.2 \Rightarrow 540 \text{ N/mm}^2$
are given in table 1e.

In case of higher torque ratings, please ask SICMEMOTORI.

Motor size	Dimensions of keywayed shaft (mm)	Uniform or light loads		Medium loads		Heavy loads	
		Steel quality	T _n (Nm)	Steel quality	T _n (Nm)	Steel quality	T _n (Nm)
80	24j6 x 50	N	67,4	N	51	N	33,7
90	28j6 x 60	N	116	N	88	N	58
100	28j6 x 60	S	140	S	103	S	70
112	28j6 x 60	N	116	N	88	N	58
132	38k6 x 80	N	296	N	212	N	141
				S	318	S	212
160	48k6 x 110	N	633	N	452	N	301
				S	678	S	452
180	55m6 x 110	N	970	N	693	N	462
				S	1040	S	693
200	65m6 x 140	N	1609	N	1149	N	766
				S	1724	S	1149
225	85m6 x 170	N	3620	N	2586	N	1724
				S	3879	S	2586
250	95m6 x 170	N	5245	N	3747	N	2498
				S	5620	S	3747
250	95m6 x 170	N	5245	N	3747	N	2498
				S	5620	S	3747
315	100m6 x 210	N	6012	N	4294	N	2863
				S	6441	S	4294
355	110m6 x 210	N	8247	N	5890	N	3927
				S	8836	S	5890
400	130m6 x 250	N	13897	N	9926	N	6618
				S	14890	S	9926
450 KRS-KS	140m6 x 250	N	17295	N	12353	N	8235
				S	18530	S	12353
450 KSM-KX	150m6 x 250	N	21673	N	15841	N	10320
				S	23221	S	15841
500 KRS-KS	160m6 x 300	N	26196	N	18711	N	12474
				S	28067	S	18711
500 KSM-KX	170m6 x 300	N	31914	N	22796	N	15197
				S	34193	S	22796
560 KRS-KS	170m6 x 300	N	31914	N	22796	N	15197
				S	34193	S	22796
560 KSM-KX	180m6 x 300	N	37045	N	26461	N	17641
				S	39691	S	26461

Table 1e

For motor sizes not indicated, please ask SICMEMOTORI.

1.f Cylindrical keyless shaft ends

Keyless shaft ends are taken into consideration only in case of special applications, with rapid and frequent overloads, accelerations and reversing of the direction of rotation, or in case of double or triple motors.

The half coupling must be shrunk-on, with suitable interference.

Nominal transmittable torques T_n for direct coupling, with normal shaft diameter D_n or maximum D_{max} (maximum diameter without changing the standard design). Of course by changing the standard design higher shaft end diameters and higher transmissible torques are available) are given in table 1f (referring to keyless shafts of the 'short' series). See 1e for the types of steel.

For higher torques special alloy steel shafts are used; upon request special keyless shafts of the long series are specified (please ask SICMEMOTORI).

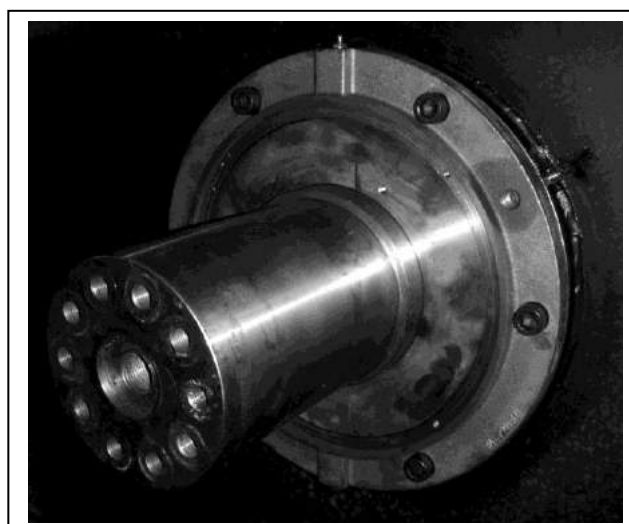

Motor size	Keyless shaft end dimensions (mm)		Medium load		Heavy load	
			Steel quality	T _n	Steel quality	T _n
132	D _n	38s6	N	323	N	215
			S	485	S	323
132	D _{max}	48s6	N	651	N	215
			S	977	S	323
160	D _n	48t6	N	651	N	434
			S	977	S	651
160	D _{max}	55t6	N	980	N	434
			S	1470	S	651
180	D _n	55t6	N	980	N	653
			S	1470	S	980
180	D _{max}	60t6	N	1272	N	848
			S	1909	S	1272
200	D _n	65t6	N	1618	N	1078
			S	2427	S	1618
200	D _{max}	70e6	N	2020	N	1347
			S	3031	S	2020
225	D _n	85u6	N	3617	N	2412
			S	5426	S	3617
225	D _{max}	88u6	N	4014	N	2676
			S	6021	S	4014
250	D _n	95u6	N	5050	N	3367
			S	7576	S	5050
250	D _{max}	98u6	N	5544	N	3696
			S	8316	S	5544
280	D _n	95u6	N	5050	N	3367
			S	7576	S	5050
280	D _{max}	98u6	N	5544	N	3696
			S	8316	S	5544
315	D _n	100u6	N	5890	N	3927
			S	8836	S	5890
315	D _{max}	103u6	N	6437	N	4291
			S	9655	S	6437
355	D _n	110u6	N	7840	N	5227
			S	11760	S	7840
355	D _{max}	117u6	N	9434	N	6290
			S	14151	S	9434
400	D _n	130u6	N	12941	N	8628
			S	19412	S	12941
400	D _{max}	136u6	N	14817	N	9878
			S	22226	S	14817
450 KRS-KS	D _n	140u6	N	16163	N	10776
			S	24245	S	16163
450 KRS-KS	D _{max}	145u6	N	17958	N	11972
			S	26937	S	17958
450 KSM-KX	D _n	150u6	N	19880	N	13254
			S	29821	S	19880
450 KSM-KX	D _{max}	155u6	N	21935	N	14624
			S	32903	S	21935
500 KRS-KS	D _n	160u6	N	24127	N	16085
			S	36191	S	24127
500 KRS-KS	D _{max}	165u6	N	26461	N	17641
			S	39691	S	26461
500 KSM-KX	D _n	170u6	N	28940	N	19293
			S	43410	S	28940
500 KSM-KX	D _{max}	175u6	N	31569	N	21046
			S	47354	S	31569
560 KRS-KS	D _n	170u6	N	28940	N	19293
			S	43410	S	28940
560 KRS-KS	D _{max}	175u6	N	31569	N	21046
			S	47354	S	31569
560 KSM-KX	D _n	180u6	N	34353	N	22902
			S	51530	S	34353
560 KSM-KX	D _{max}	185u6	N	37296	N	24864
			S	55944	S	37296
630 KRS-KS	D _n	180	N	34353	N	22902
			S	51530	S	34353
630 KRS-KS	D _{max}	210	N	54552	N	36368
			S	81828	S	54552
630 KSM-KX	D _n	200	N	47124	N	31346
			S	70686	S	47124
630 KSM-KX	D _{max}	210	N	54552	N	36368
			S	81828	S	54552

Table 1f

Motor size	Keyless shaft end dimensions (mm)		Medium load		Heavy load	
			Steel quality	T _n	Steel quality	T _n
710 KRS-KR	D _n	200	N S	47124 70686	N S	31346 47124
	D _{max}	240	N S	81430 122145	N S	54287 81430
710 KS-KM	D _n	220	N S	62722 94083	N S	41815 62722
	D _{max}	240	N S	81430 122145	N S	54287 81430
710 KML-KX	D _n	240	N S	81430 122145	N S	54287 81430
	D _{max}	250	N S	92039 138058	N S	61359 92039
800 KRS-KR	D _n	220	N S	62722 94083	N S	41815 62722
	D _{max}	290	N S	143663 215494	N S	95775 143663
800 KS-KM	D _n	240	N S	81430 122145	N S	54287 81430
	D _{max}	290	N S	143663 215494	N S	95775 143663
800 KML-KX	D _n	260	N S	103531 155297	N S	69021 103531
	D _{max}	290	N S	143663 215494	N S	95775 143663

Table 1f

For motor sizes not indicated, please ask SICMEMOTORI.

1.g Pulley coupling – Maximum admissible radial loads

The radial load F_r applied at the shaft end corresponds reasonably closely to the 'belt pull' needed for correct torque transmission, when the torque transmission is made through a pulley-belt system. Admissible radial load F_r (in N) for motors with horizontal shaft and load applied at a distance X (calculated for the longest machines and for standard DE bearings) is shown in table 1g.1.

Motor size	X (mm)	Speed (rpm)							
		600	750	1000	1500	2000	2500	3000	3500
80	25		1970	1920	1550	1450	1340	1270	1150
	50	1200							1130
90	30		2580	2320	2020	1830	1680	1570	1500
	60	1500							
100	40		3750	3400	2950	2660	2460	2300	2180
	80	3150			2750	2500	2300	2150	2050
112	40	4020		3360	2910	2620	2420	2260	2140
	80	3500		3150	2730	2460	2270	2130	2020
132	40	5840		4870	4210	3800	3500	3280	3100
	80	3000							
160	55	7530		6270	5410	4870	4480	4180	3950
	110	4200							3920
180	55	7340		6060	5180	4630	4230	3930	3690
	110	5500		5500	4910	4380	4010	3720	3500
200	70	9090		9470	6370	5680	5180	4800	---
	140	7900		7010	5980	5320	4860	4500	---
225	85	25000		23000	20500	18000	17000	16000	---
	170	15000							13000
250	85	32000			28000	26000	24000	---	---
	170	20000				18000		---	---
280	85	24000				---		---	---
	170	15000				---		---	---
315	105	12000				---		---	---
	210	8000				---		---	---

Table 1g.1

Frames 112-200 are available with DE roller bearing too, which allow a higher radial load F_r; in that case, admissible radial load F_r is shown in table 1g.2. Roller bearings are shown in table 1g.3.

Motor size	X (mm)	Speed (rpm)							
		600	750	1000	1500	2000	2500	3000	3500
112	40	7000			6750	6300	5960	5680	
	80	3500							
132	40	5840							
	80	3000							
160	55	8500							
	110	4200							
180	55	11200					10720	10200	
	110	5500							
200	70	15700				15150	14280	---	
	140	7900							---

Table 1g.2

All admissible radial loads are valid for uniform or medium loads (see 1d) for a theoretical bearing life of 20,000 hours. For larger sizes and for heavy loads please ask SICMEMOTORI. Coupling with belt and pulley is inadvisable with heavy loads!

Motor size	DE roller bearing		Motor size	DE roller bearing	
	Type	SICMEMOTORI code		Type	SICMEMOTORI code
P112	NJ308-C3	8.3.09.64.040.0	P180	NU312-C3	8.3.09.63.060.0
P132	NJ310-C3	8.3.09.64.050.0	P200	NU314-C3	8.3.09.63.070.0
P160	NJ312-C3	8.3.09.64.060.0			

Table 1g.3

Radial load F_r is calculated using the following formula:

$$F_r = \frac{19,1 \times P \times K \times 10^6}{D_p \times n}$$

Where:

F_r = radial load on shaft in N

P = nominal power of the motor in kW

n = motor speed in rpm

D_p = pulley pitch diameter in mm

K = belt tension coefficient approximating to:

K = 1 for toothed belts

K = 2.35 for trapezoidal belts

K = 3.75 for flat normal leather belts

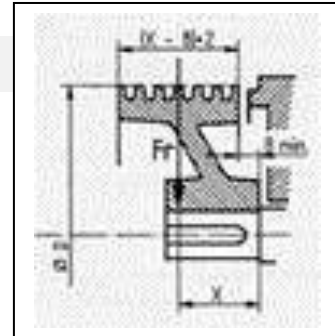

The point X of application of the load F_r on the shaft depends on the type and number of belts used and in the case of trapezoidal belts it can be determined making reference to table 1g.4.

For larger machines please ask SICMEMOTORI.

Number of belts	Trapezoidal belt section					
	SPA-A	SPB-B	SPC-C	D	5V	8V
	X	X	X	X	X	X
2	26	30	38	50	30	41
3	33	40	50	69	39	56
4	40	49	63	88	47	70
5	48	59	76	106	56	84
6	56	68	89	125	65	99
7	63	78	102	145	74	113
8	70	87	114	165	83	127
9	78	97	127	181	91	142
10	85	106	140	199	100	156
11	93	115	153		109	170
12	100	125	166		117	184
13	108	135	179		126	199
14	115	144	192		135	213
15	123	153	205		144	
16	130	163			153	
17	138	172			161	
18	145	182			170	
19	153	191			178	
20	160	201			187	
21	168	210			196	
22	175				205	
23	183					
24	190					
25	198					
26	205					
27	212					

Table 1g.4

Under all circumstances dimension X should always be:

- < 50 mm for size 80
- < 60 mm for size 90
- < 80 mm for sizes 100-112
- < 170 mm for sizes 225-250-280
- < 210 mm for size 315

Please refer to SICMEMOTORI for conditions with higher X.
SICMEMOTORI is willing to verify suitability by calculations, once F_r and X are known.

Example of check for radial load F_r

Supposing we need to check the radial load of a motor defined as follows:

- motor type: NP 250 KS5
 - transmission: trapezoidal belt
 - power P:206 kW
 - speed n: 1000 rpm
 - number of belts: 11
 - type of belts: SPC
 - pulley diameter: 330 mm
- Applying the formula and replacing the figures we have:

$$F_r = 19,1 \times 206 \times 2,35 \times 1.000.000 / (1000 \times 330) = 28019 \text{ N}$$

From table 1g.4 dimension X is 153 mm.

Knowing the radial load and the distance of application, the max. allowable load should be checked on the table 1g.1 for motor NP 250 KS in relation to X = 153.

The pulley chosen is unsuitable because the radial load is higher.

The check should be carried out again with a higher pulley diameter to reduce the load. Supposing the use of a 410 diam. pulley, we would obtain a load F_r of 22551N, which is below the allowable load.

The new transmission parameter is suitable. The result of this check established that with the number and section of belts required by the customer, the pulley must have a minimum diameter of 410 mm.

If any doubts arise always please ask SICMEMOTORI.

1h Special bearings for direct coupling

When coupling between motor and load is direct (by coupling or by cardan joint), a DE ball bearing can be used instead of the standard DE roller bearing (for frames 225-630). Table 1h shows the type of DE ball bearing are used in that case. In case of doubt please ask SICMEMOTORI.

Motor size	DE ball bearing		Motor size	DE ball bearing	
	Type	SICMEMOTORI code		Type	SICMEMOTORI code
225	6315-C3	8.3.09.17.075.0	500KRS-KS	6234-C3	8.3.09.09.170.0
250	6318-C3	8.3.09.17.090.0	500KSM-KX	6236-C3	8.3.09.09.180.0
280	6318-C3	8.3.09.17.090.0	560KRS-KS	6236-C3	8.3.09.09.180.0
315	6321-C3	8.3.09.17.105.0	560KSM-KX	6238-C3	8.3.09.09.190.0
355	6324-C3	8.3.09.17.120.0	630KRS-KS	6238-C3	8.3.09.09.190.0
400	6228-C3	8.3.09.09.140.0	630KSM-KX	6244-C3	8.3.09.09.220.0
450KRS-KS	6230-C3	8.3.09.09.150.0			
450KSM-KX	6232-C3	8.3.09.09.160.0			

Table 1h

2. INFORMATION ON DUTY CYCLES

The correct definition of the duty cycle is essential to design electrically and mechanically the best D.C. machine to suit the load requirements.

For that reason, the Customer must contact SICMEMOTORI any time it has difficulty in defining the right duty cycle of the D.C. machine, and cannot relate it to one of the duty cycles defined by IEC 60034-1 Standards.

IEC Std. 60034-1 defined 10 types of duty, names with the letter S followed by a number from 1 to 10, which describe all types of possible duties a D.C. machine can work.

For all motors with duty from S4 to S10, SICMEMOTORI has an internal quality procedure to check that all motor parameters are suitable for the application required.

In table 2 a short description of duties as defined by IEC Std. 60034-1 is given. For more information please ask SICMEMOTORI or consult the Standards.

Duty type	Description	Diagram
S1	Continuous running duty Operation at constant load maintained for sufficient time to reach machine thermal equilibrium.	
S2	Short-time duty Operation at constant load, for a given time, less than that required to reach machine thermal equilibrium, followed by a time at rest, of a duration sufficient to re-establish machine original temperature. S2 is followed by the indication of the duration of the duty (ex.: S2 60 min; S2 30 min; ecc.).	
S3	Intermittent periodic duty A sequence of identical duty cycles, each one including a time of operation at constant load and a time at rest. The starting current does not significantly affect the temperature rise of the machine. S3 is followed by the cyclic duration factor (ex.: S3 60%; S3 25%; ecc.).	
S4	Intermittent periodic duty with starting A sequence of identical duty cycles, each one including a significant starting time, a time of operation at constant load and a time at rest. S4 is followed by the cyclic duration factor, the moment of inertia of the D.C. machine and the moment of inertia of the load (ex.: S4 60% J _{dc} J _{load}).	
S5	Intermittent periodic duty with electric braking A sequence of identical duty cycles, each one consisting of a starting time, a time of operation at constant load, a time of electric braking and a time at rest. S5 is followed by the cyclic duration factor, the moment of inertia of the motor and the moment of inertia of the load (ex.: S5 30% J _{dc} J _{load}).	

Duty type	Description	Diagram
<p>S6</p>	<p>Continuous operation periodic duty A sequence of identical duty cycles, each one consisting of a time of operation at constant load and a time of operation at no load. There is no time at rest. S6 is followed by the cyclic duration factor (ex.: S6 40%).</p>	
<p>S7</p>	<p>Continuous operation periodic duty with electric braking A sequence of identical duty cycles, each one consisting of a starting time, a time of operation at constant load and a time of electric braking. There is no time at rest. S7 is followed by the cyclic duration factor, the moment of inertia of the motor and the moment of inertia of the load (ex.: S7 30% $J_{dc} J_{load}$).</p>	
<p>S8</p>	<p>Continuous operation periodic duty with related load/speed changes A sequence of identical duty cycles, each one consisting of a time of operation at constant load corresponding to a predetermined speed of rotation, followed by one or more times of operation at other constant loads corresponding to different speeds of rotation. There is no time at rest. S8 is followed by the moment of inertia of the motor, the moment of inertia of the load, and the load, speed and cyclic duration factor for each speed conditions.</p>	
<p>S9</p>	<p>Duty with non-periodic load and speed variations A duty in which load and speed vary non-periodically within permissible operating range. The duty includes frequently applied overloads that may greatly exceed the reference load. For this duty type a constant load approximately selected and based of duty S1 is taken as the reference value (P_{ref} in the diagram) for the overload concept.</p>	
<p>S10</p>	<p>Duty with discrete constant loads A duty consisting of not more than four discrete values of load (or equivalent loading), each value being maintained for sufficient time to allow the machine to reach the thermal equilibrium. The minimum load within a duty cycle may have the value zero (no load or rest).</p>	

Table 2

Notes: Periodic duty implies that thermal equilibrium is not reached during the on load time.
 Moments of inertia are referred to the motor shaft

3. D.C. MOTORS FOR SOME TYPICAL INDUSTRIAL APPLICATION

SICME MOTORI SpA has been one of the first Italian Company's to design and manufacture d.c. motors for variable speed drive for industrial application's. During its more than 40 years of history, thousand of motors have been manufactured and installed all over the world, in a huge number of different industrial applications.

Here some of the most common application are described, where SICMEMOTORI has developed motors with special features to comply with the different needs of the applications and to respond in terms of quality and reliability to the different applications.

3.a Motors for plastic and rubber industries – SICMEPLASTIC & RUBBER

Since the beginning of variable speed drives, plastic and rubber industries have been utilized d.c. motors.

SICMEMOTORI d.c. motors are widely installed in extruders, plants for plastic tubes production, machines for cables coating, turbomixers, calenders, plants for plastic film production, machines for tyres production, etc..

A very severe application for d.c. motors is banbury mixers, where SICMEMOTORI has a very long experience. SICMEMOTORI d.c. motors for banbury mixers have the following main features:

- compensating windings (high overloads);
- degree of protection normally IP44 or higher (the environment is normally very dirty);
- type of cooling IC86W;
- most commonly used accessories: tachogenerator, pulse generator, pressure switch, transparent inspection doors, heaters, bearing vibration sensors, thermoprotectors

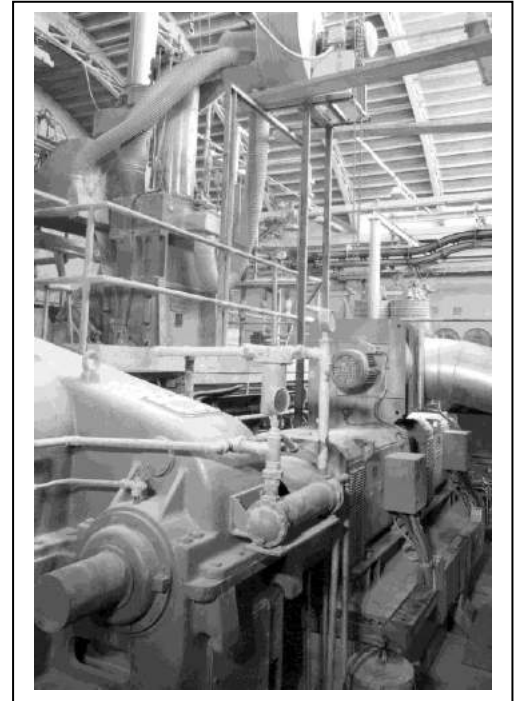

3.b Motors for metal industries – SICMETAL

SICMEMOTORI d.c. motors are currently used by many of the most important European manufacturers to equip their plants or machines in the difficult environment of the steel and metal industries.

- Cold and hot rolling mills, reversing and non-reversing, for steel and aluminium
 - o normally motors are electrically and mechanically dimensioned to comply with Nema standards;
 - o compensating windings (high overloads and wide constant power speed regulation by field weakening);
 - o degree of protection IP44 or more (usually);
 - o type of cooling IC86W or IC37;
 - o insulation class H;
 - o temperature rise class F;
 - o keyless shaft;
 - o tandem or triple motors are normally requested for stands or for winders;
 - o most commonly used accessories: tachogenerator, pulse generator, overspeed switch, pressure switch, transparent inspection doors, heaters, bearing vibration sensors, thermoprotectors



- Wire drawing machines
 - o degree of protection IP23 or IP44;
 - o type of cooling IC06, IC17 or IC37;
 - o most commonly used accessories: tachogenerator, pulse generator, pressure switch, filter, thermoprotectors
- Start-stop shears
 - o compensating windings (high repeated overloads);
 - o degree of protection IP44 or more;
 - o type of cooling IC86W;
 - o keyless shaft;
 - o most commonly used accessories: tachogenerator, pulse generator, pressure switch, heaters, thermoprotectors



Other applications where SICMEMOTORI d.c. motors are used are: finishing lines (painting, tinning, galvanizing, etc.), cutting lines, cable machines, etc..

3.c Motors for cranes and hoisting equipments – SICMECRANE

SICMEMOTORI d.c. motors for cranes and hoisting equipments are manufactured according to the long experience SICMEMOTORI has in these particular sectors.

Some application: jib cranes, grabbing cranes, gantry cranes, rubber tyred gantry cranes, for containers, elevators, unloading platforms.

Typical features for D.C. motors:

- Main and boom hoisting
 - o degree of protection IP23 (usually), as the motor (or the motors) is normally installed inside the operating cab;
 - o type of cooling IC06;
 - o mounting IM1001 (sometimes IM1002, when a second shaft end is required for the brake);
 - o compensating windings;
 - o most commonly used accessories: tachogenerator, pulse generator, overspeed switch, pressure switch, transparent inspection doors, filter.
- Trolley
 - o degree of protection IP23 (usually), if the motor (or the motors) is installed inside the winch cab; type of cooling IC06;
 - o degree of protection IP55 (or IPW55) if the motor (or the motors) is installed in the open air or under shelter; typical coolings IC410 – IC610;
 - o compensating windings if max torque is higher than 2 nominal torque.
 - o most commonly used accessories: tachogenerator, pulse generator, electromagnetic brake, filter and pressure switch (for IP23 motors only), thermoprotectors, transparent inspection doors.
- Gantry
 - o degree of protection IP55 (or IPW55); typical cooling IC410 – IC610;
 - o compensating windings if max torque is higher than 2 nominal torque.
 - o most commonly used accessories: tachogenerator, pulse generator, electromagnetic brake, thermoprotectors, transparent inspection doors.
- Jib slewing
 - o degree of protection IP23 (usually), as the motor (or the motors) is normally installed inside a cab;
 - o type of cooling IC06
 - o most commonly used accessories: tachogenerator, pulse generator, filter, thermoprotectors, pressure switch, transparent inspection doors.



All motors are tropicalized, with stainless steel screws and bolts and anticorrosive epoxy painting, anticondensation heaters, filter and pressure.

For all motors: insulation class H, temperature rise class F.

Other very important and severe application is:

- **Blondins**
 - o compensating windings;
 - o degree of protection IP23;
 - o type of cooling IC06;
 - o mounting IM1001;
 - o most commonly used accessories: tachogenerator, pulse generator, filter, thermoprotectors, pressure switch, transparent inspection doors.

3.d Motors for mining industries – SICMEMINING

During its history SICMEMOTORI has acquired a wide experience in the mining industries, in particular for winders for people and materials, where reliability is of great importance, as these plants are working continuously 24 hours a day for many months.

Main characteristics of motors for such applications are:

- o compensating windings;
- o insulation class H;
- o temperature rise class B (or F);
- o torque capacity 200% for 20 seconds;
- o electrical and mechanical design to make the motors able to endure the very heavy working conditions in terms of vibrations, overloads, dirty environment, etc.;
- o keyless or double tangential key shaft;
- o most commonly used accessories: tachogenerator, pulse generator, heaters, vibration monitor, Pt100 thermoprotectors, earth brush.

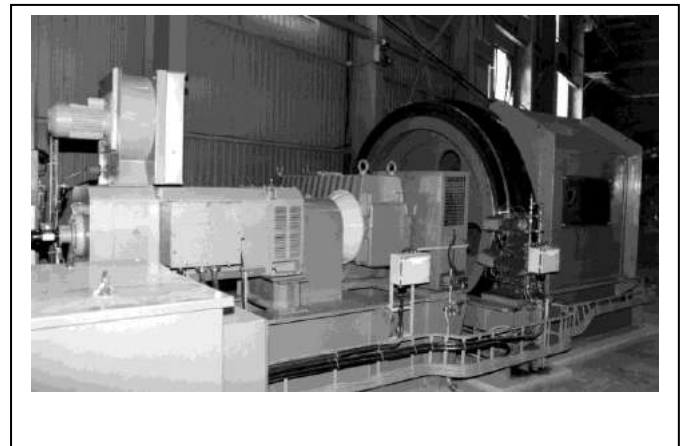
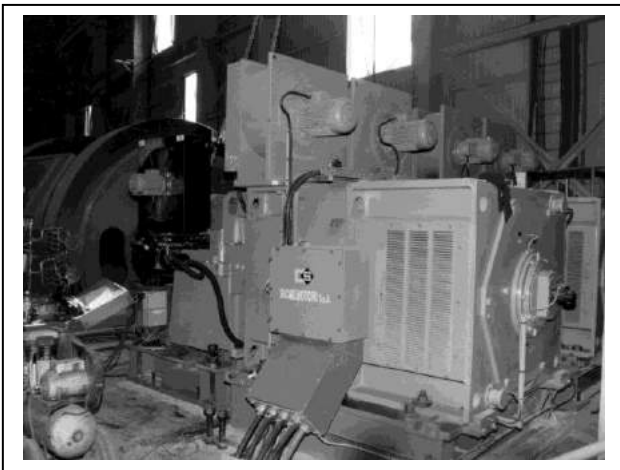
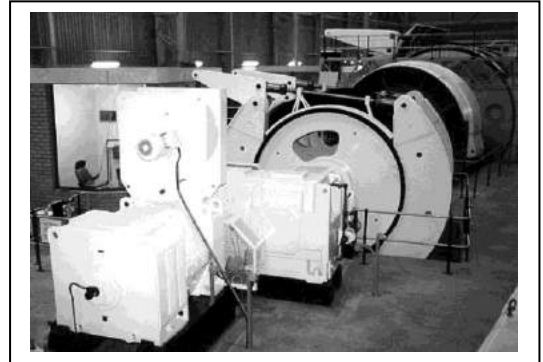

3.e Motors for skylift and cableways – SICMESNOW

SICMEMOTORI d.c. motors have been selected by the most important world manufacturers of installations to drive skylifts, chairlifts, funiculars, cableways, DMC, etc. and, lastly, the snow guns to produce artificial snow.

Main features for D.C. motors for this specific application are the following:

- compensating winding, in particular for chairlifts, cableways, funiculars and DMC plants; compensation is necessary to assure the starting torque during the re-starting of a plant that for any reason has been stopped during the normal working;
- degree of protection IP23;
- cooling IC06;
- mounting IM1001 (usually);
- silencers to reduce noise level;
- brush wear control device;
- transparent inspection doors;
- DE ball bearing when direct coupling D.C. motor – load.

Most commonly used accessories: tachogenerator, pressure switch, filter, thermoprotectors.

Many applications with tandem motors have been also realized, to give more flexibility to the plant.

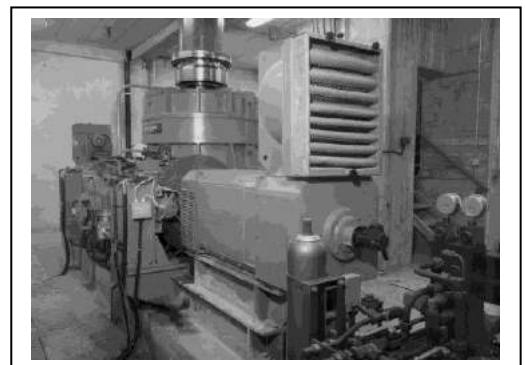

3.f Motors for paper and print industries – SICMEPAPER & PRINT

SICMEMOTORI d.c. motors are widely used in paper production machines, flexographic machines, printing machines, coating machines and packing machines.

Motors for paper production must be protected against the humidity and the paper powder, so that normally degree of protection is minimum IP44, with type of cooling IC37 (ducted machines). Machines with degree of protection IP23 and type of cooling IC17 can also be used.

Some flexographic and printing machines must be overpressurized, to prevent the external dangerous atmosphere to enter into the motors and to create danger of fire or explosion.

3.g Motors for food industries

SICMEMOTORI is proud of its wide experience in particular for d.c. motors for sugar centrifuge. This is a very heavy application from the mechanical point of view, as overloads and high vibrations are induced by the load directly to the motor, which must be designed and manufactured accordingly.

Many hundreds of sugar centrifuges have been working for many years all over the world.

Main features of a d.c. motor for sugar centrifuge:

- compensating winding;
- degree of protection IP23;
- type of cooling IC16;
- mounting IM3011;
- very robust mechanical construction, in particular the stator frame and the DE flange (steel welded);
- most commonly used accessories: tachogenerator, pressure switch, special filter for sugar powder, thermoprotectors

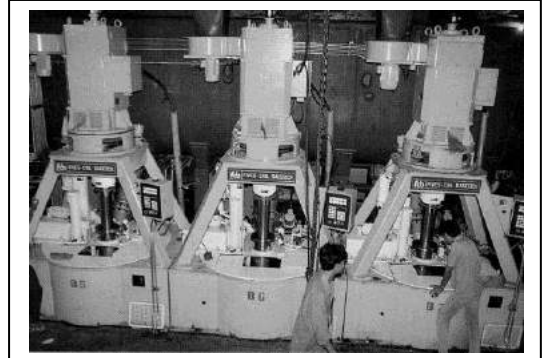
**3.h Motors for cement factories**

SICMEMOTORI d.c. motors are widely used in cement factories, where a high degree of protection is normally requested, due to the very dusty environment where the motors are installed.

Main features of d.c. motors for such applications are:

- compensating winding;
- degree of protection IP55;
- cooling methods IC666 (air-air cooler) or IC86W (air-water cooler);
- mounting IM1001;
- high starting torque (>2 Tn), especially for motors for rotary kilns;
- most commonly used accessories: tachogenerator, pulse generator, overspeed switch, pressure switch, transparent inspection doors, heaters, bearing vibration sensors, thermoprotectors.

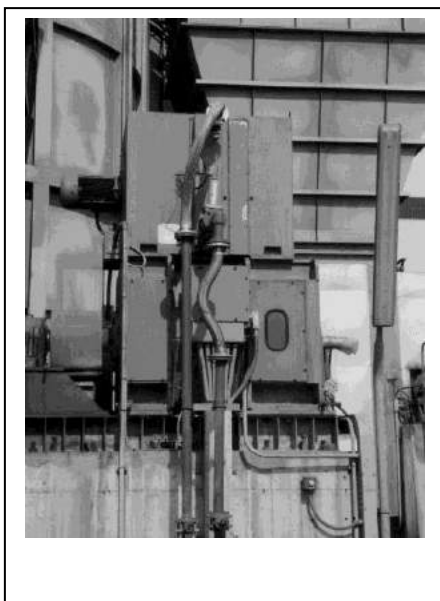

4. SOME NOTES ABOUT D.C. MACHINES

Though direct current machines are subdivided into generators and motors, we are going to talk generically about D.C. motors, as they are by far the most widely used.

A D.C. motor is an electrical machine which transforms electrical energy into mechanical rotating energy.

In the following paragraphs we are going to briefly cover some of the basic properties of this type of machine.

4.a General features

A D.C. motor basically comprises two parts:

- a static section, known as stator, which has the purpose of creating the main magnetic flux; main and auxiliary (or commutating) poles form part of the stator;
- a rotating section, known as rotor (also called armature), cut by the magnetic field created by the stator. The rotor is composed of the rotor pack and the commutator. Rotor pack and commutator are shrunk-on the shaft.

Mechanically, rotor and stator are held together by the end shields.

4.b Stator and stator windings structure

In all P-NP motors the stator (frame) is made by a series of iron laminations pressed and held together by suitable welded rods. This type of construction (which distinguishes the D.C. motors with laminated frame) improves the exploitation of the space, the dynamic response, the commutation and therefore also improving the exploitation of the motor (greater specific torque).

Main and commutating poles are made by magnetic laminations with low losses, and are fastened to the stator.

Excitation coils and, when foreseen, the slots with the compensating coils are fitted on the main poles. The excitation coils, when crossed by the energising current (field or excitation current) create the main magnetic flux.

The compensation coils, set in special slots made expressly on the polar expansions of the main poles, are crossed by the armature current, to reduce the effect of the "armature reaction".

The auxiliary (or commutating) coils are fitted on the auxiliary (or commutating) poles. These have the task of enabling current commutation to the brushes on the commutator.

4.c Rotor structure

The rotor is comprised of the shaft, the rotor pack and the commutator.

The rotor pack is formed by pressed magnetic laminations, held by aluminium end flanges which also have the task of supporting the rotor end windings.

The rotor has on its external surface a series of slots which house the rotor winding. Number and shape of slots depend on the type of winding.

The commutator is made by copper bars insulated with mica plates. Rotor winding ends are strongly welded to the commutator bars.

The rotor pack and the commutator are shrunk-on the shaft, without using any key. This makes the motor sturdier, especially in case of operation with sharp acceleration and deceleration or sudden speed changes, as the torque generated in the rotor pack is transmitted to the load by the whole shaft-pack surface, and not only by the shaft key.

4.d Brushes

Carbon brushes slide on the commutator surface. Their number and size depend on the rating of the armature current, and their function is to transmit the current which is fed by the outside supply source to the rotor winding (commutation).

4.e General operating principles and main formulas

Generally speaking, the creation of the torque available at the motor shaft is due to the combined action of two separate electric circuits, each one generating a magnetic field, the combination of which generates the torque.

The two separate electric circuits are the following:

- the energising circuit, placed on the stator, the coils of which are crossed by the energising current I_e , which originates the main flux Φ ; this is the excitation circuit crossed by the excitation (of field) current I_e ;
- the rotor circuit, the winding of which is crossed by the armature current I_a .

Anybody wishing to go deeper into the knowledge about D.C. motor can consult the numerous books on this subject in commerce.

Here we are only going to examine some of the main formulas which govern its operation and its behaviour as certain external parameters vary.

To start with, let us define the quantities to be considered:

- *armature voltage* V_a (V) : continuous voltage applied at the terminals of the armature winding;
- *nominal speed rate* n (rpm) : it is the motor speed when it is supplied with the nominal armature voltage V_a and the nominal excitation current (voltage) I_e (V_e);
- *armature current* I_a (A) : direct current that passes through the armature winding;
- *nominal power rating* P (kW) : power delivered by the motor at nominal speed, when it is supplied with nominal voltage V_a and nominal excitation current I_e ;

- *armature resistance* R_a (ohm) : electrical resistance of the armature circuit;
- *efficiency* η : efficiency of the armature circuit;
- *excitation voltage* V_e (V) : continuous voltage applied to the excitation winding;
- *excitation resistance* R_e (ohm) : electrical resistance of the excitation winding;
- *excitation current* I_e (A) : direct current that flows through the excitation winding;
- *nominal torque* T_n (Nm) : torque delivered by the motor at nominal speed, when it is supplied with armature voltage V_a and nominal excitation current I_e ;
- *main magnetic flux* \emptyset (Wb) : flux created by the passage of the excitation current I_e through the excitation winding.

The above-mentioned quantities are governed by the following main formulas:

- $P_n = V_a \times I_a \times \eta$
- $I_e = V_e / R_e$
- $T_n = K \times \emptyset \times I_a$
- $P_n = (T_n \times n) / K$

Following comments can be made:

- P_n and V_a are directly proportional;
- P_n and n are directly proportional (with constant I_e);
- V_a and n are directly proportional (with constant I_e);
- T_n and I_a are directly proportional (with constant I_e);
- T_n and \emptyset are directly proportional;
- T_n and n are inversely proportional in the constant power range;

Therefore, in a motor increasing or decreasing V_a increase or decrease proportionally n and P_n (with constant I_e).

In the same way, T_n increases if I_a increases (with constant I_e). T_n also increases as \emptyset increases (i.e., as I_e increases), though I_a is kept constant (this means a reduction of speed).

4.f Speed adjustment

From the above it may be derived that in order to change the D.C. motor speed, it is sufficient to change its armature voltage V_a (maintaining constant I_e and I_a), which is extremely easy to do with modern static power converters; this type of speed adjustment is called “**at constant torque**”, as the flux \emptyset and the currents which create the torque (I_e and I_e and I_a) remain constant, while the power increases because increasing the V_a from 0 to the nominal rating increases the product $V_a \times I_a$.

But another way exists to change the speed of a D.C. motor: it is that of reducing the excitation current I_e , and thus also the flux \emptyset , keeping constant the armature voltage V_a and current I_a . This type of speed adjustment is called “**at constant power**”, because V_a and I_a remain unchanged and so the power also remains constant, while the torque rating is lowering (this way of adjusting the motor speed is normally called “**field weakening**”, as it is obtained by reducing the I_e and thus the excitation flux).

The choice of one type of speed adjustment rather than the other depends on the type of application.

The above is valid in case it is possible to supply the excitation circuit from a source independent from the armature circuit one: a motor allowing that is called “with separate excitation”.

Separate excitation is by far the mostly used type of excitation in modern D.C. motors, as it gives the greater flexibility to it.

4.g Some note about D.C. generators

A D.C. motor transforms electrical energy into mechanical energy.

Vice versa, a D.C. generator transform mechanical energy into direct electrical energy.

Its configuration, like its operation, is quite similar to that of the motor, with the difference that while in the motor I_a enters into the armature windings, in the generator I_a exits by them.

Nowadays D.C. generators are very rarely used, and their use is generally restricted to cases in which there is no ac network to be rectified by bridges, or when an interruption of the working cycle caused by a drop in the network is absolutely to be avoided.

5. SOME USEFUL FORMULAS

Power in linear motion Power in rotary motion	$P = (F \times v)/(1000 \times \eta)$ $P = (T \times \omega)/(1000 \times \eta)$	$F = 9,81 \times m$ (on lifting) $F = 9,81 \times f \times m$ (on translation) $v = s/t$ $\omega = 2\pi \times n/60$ $v = \omega \times d/2$
Torque Torque as function of Force Torque as function of Power Torque as function of Inertia	$T = F \times b$ $T = 9549 \times P/n$ $T = 1000 \cdot P/\omega$ $T = J \times \omega/t$	
Dynamic moment PD^2	$PD^2 = 4 \times J$	
Moment of inertia J	$J = PD^2/4$	
Electric power	<i>Direct current</i> $KW = (V \times A) / 1000$	<i>Single-phase alternative current</i> $KW = (V \times A \times \cos\phi) / 1000$ <i>Three-phase alternative current</i> $KW = 1,73 \times (V \times A \times \cos\phi) / 1000$
Electric quantities	<i>Direct current</i> $V = W/A = A \times \Omega$ $A = W/V = V/\Omega$ $\Omega = V/A = W/A^2 = V^2/W$	<i>Alternative current</i> $V = W/(A \times \cos\phi)$ $A = W/V \times \cos\phi$ $W = V \times A \times \cos\phi$

P	:	power (kW)
F	:	force (N)
V	:	voltage (Volt)
A	:	current (Ampere)
cosφ	:	power factor
Ω	:	resistance (Ohm)
v	:	linear speed (m/sec)
η	:	efficiency
f	:	friction coefficient
s	:	space (m)
t	:	time (sec)
T	:	torque (Nm)
m	:	mass (kg)
n	:	speed (rpm)
ω	:	angular speed (rad/sec)
J	:	moment of inertia (kgm ²)

6. CONVERSION TABLES

SI units:

Length	:	m (meter)
Mass	:	kg (kilogram)
Force and weight	:	N (Newton)
Pressure	:	Pa (Pascal)
Torque	:	Nm (Newton meter)
Power	:	kW (kiloWatt)
Energy	:	J (Joule)
Temperature	:	K (Kelvin)

A Length

1 yard = 3 feet 1 foot = 12 inches 1 inch = 1000 mils
 1 mile (land) = 5280 feet = 1760 yards
 1 mile (nautical) = 6080,20 feet
 1 fathom (nautical) = 6 feet = 2 yards

To convert from:	to:	multiply by:
mm	mils	39,37
mm	inches	0,03937
cm	inches	0,3937
cm	feet	0,03281
m	inches	39,37
m	feet	3,281
m	yards	1,0936
Km	miles (land)	0,6214
Km	miles (nautical)	0,5396
m	fathoms (naut)	0,5468

To convert from:	to:	multiply by:
mils	mm	0,0254
inches	mm	25,4
inches	cm	2,54
feet	cm	30,48
inches	m	0,0254
feet	m	0,3048
yards	m	0,9144
miles (land)	km	1,6093
miles (nautical)	km	1,8532
fathoms (nautical)	m	1,8288

B Surface

1 circular mil = 0,7854 square mils

To convert from:	to:	multiply by:
mm ²	circular mils	1973,5
mm ²	square inches	0,00155
cm ²	square inches	0,155
m ²	square feet	10,764

To convert from:	to:	multiply by:
circular mils	mm ²	0,0005067
square inches	mm ²	645,2
square inches	cm ²	6,452
square feet	m ²	0,0929

C Volume

1 gallon = 4 quarts = 231 cubic inches (USA) = 277,4 cubic inches (UK)

To convert from:	to:	multiply by:
cm ³	cubic inches	0,06102
m ³	cubic feet	35,31
L	gallons (UK)	0,2199
L	gallons (USA)	0,2642

To convert from:	to:	multiply by:
cubic inches	cm ³	16,387
cubic feet	m ³	0,02832
gallons (UK)	l	4,5459
gallons (USA)	l	3,7846

D Speed

To convert from:	to:	multiply by:
m/sec	feet per second	3,284
Km/h	miles per hour	0,9114
Km/h	miles per hour	0,6214

To convert from:	to:	multiply by:
feet per second	m/sec	0,3048
miles per hour	Km/h	1,0972
miles per hour	Km/h	1,6093

E Weight

1 pound = 16 ounces = 7000 grains
 1 short-ton = 2000 pounds
 1 long-ton = 2240 pounds

To convert from:	to:	multiply by:
g	grains	15,432
g	ounces	0,0353
kg	pounds	2,2046
kg	short-tons	0,001102
kg	long-tons	0,000984
t	short-tons	1,102
t	long-tons	0,984

To convert from:	to:	multiply by:
grains	g	0,0648
ounces	g	28,3495
pounds	kg	0,4536
short-tons	kg	907,1853
long-tons	kg	1016,047
short-tons	t	0,9072
long-tons	t	1,016

F Energy

1 BTU (British Thermal Unit) = quantity of heat necessary to warm 1 pound of water of 1°F

To convert from:	to:	multiply by:
cal	BTU	3,969
kgm	BTU	0,009294
j	BTU	0,000948
kwh	BTU	3413
CVh	BTU	2545

To convert from:	to:	multiply by:
BTU	cal	0,252
BTU	kgm	107,58
BTU	j	1054,4
BTU	kwh	0,000293
BTU	CVh	0,000398

G Others

To convert from:	to:	multiply by:
kp	N	9,807
p	N	0,0981
lb	N	4,4482
mm Hg	Pa	131
Nm ⁻²	Pa	1
bar	Pa	10 ⁵
Kgf m	Nm	9,8067
lb ft	Nm	1,356

To convert from:	to:	multiply by:
Lb in	Nm	0,1129
oz in	Nm	0,007062
HP	kW	0,7457
cal	J	4,187
°C	K	1
t°C	K	t + 275,15
°F	K	0,555
t°F	K	(t-32) x 0,555

H Equivalence between different units of energy

	erg	cal	Kgm	J	kWh	CVh
1 erg	1	0,239 x 10 ⁻¹⁰	1,02 x 10 ⁻⁸	10 ⁻⁷	2,778 x 10 ⁻¹⁴	3,777 x 10 ⁻¹⁴
1 cal	4,186 x 10 ¹⁰	1	426,9	4186	1,163 x 10 ⁻³	1,581 x 10 ⁻³
1 kgm	9,307 x 10 ⁷	2,342 x 10 ⁻³	1	9,807	2,724 x 10 ⁻⁶	3,704 x 10 ⁻⁶
1 J	10 ⁷	2,39 x 10 ⁻⁴	0,102	1	2,778 x 10 ⁻⁷	3,777 x 10 ⁻⁷
1 kWh	3,6 x 10 ¹³	860	3,673 x 10 ⁶	3,6 x 10 ⁶	1	1360
1 CVh	2,648 x 10 ¹³	632,5	2,7 x 10 ⁶	2,648 x 10 ⁶	0,7355	1

I Equivalence between different units of power

	erg/sec	cal/sec	Kgm/sec	w	kW	CV
1 erg/sec	1	0,239 x 10 ⁻¹⁰	1,02 x 10 ⁻⁸	10 ⁻⁷	10 ⁻¹⁰	1,36 x 10 ⁻¹⁰
1 cal/sec	4,186 x 10 ¹⁰	1	426,9	4184	4,184	5,692
1 kgm/sec	9,307 x 10 ⁷	2,342 x 10 ⁻³	1	9,807	9,807 x 10 ⁻³	1,333 x 10 ⁻²
1 w	10 ⁷	0,2388 x 10 ⁻³	0,102	1	10 ⁻³	1,360 x 10 ⁻³
1 kW	10 ¹⁰	0,2388	102	10 ³	1	1,360
1 CV	7,355 x 10 ⁹	0,176	75	735,5	0,7355	1

L Equivalence between horse power and kilowatt

	CV	HP	kW	Kgm/sec
CV	1	0,9863	0,7355	75
HP	1,0139	1	0,7457	76,05
KW	1,360	1,341	1	101,98

7. LOW VOLTAGE INDUSTRIAL ELECTRICITY SUPPLY IN SOME COUNTRIES

Continent	Country	V	Hz	Continent	Country	V	Hz	
Europe	Albania	220/380	50	Asia	Afghanistan	220/380	50	
	Austria	230/400	50		Azerbaijan	220/380	50	
	Belarus	220/380	50		Bahrain	230/400	50	
	Belgium	230/400	50			110/115	60	
	Bosnia and Herzegovina	220/380	50		Bangladesh	220/380	50	
	Bulgaria	230/400	50		Brunei	240/415	50	
	Croatia	230/400	50		Cambodia	230/400	50	
	Cyprus	240/415	50		China, People's Rep. of	220/380	50	
	Czech Republic	230/400	50		Hong Kong	220/380	50	
	Denmark	230/400	50		India	240/415	50	
	Estonia	230/400	50		Indonesia	220/380	50	
	Finland	230/400	50		Iran	230/400	50	
	France	230/400	50		Iraq	230/400	50	
	Georgia	220/380	50		Israel	230/400	50	
	Germany	230/400	50		Japan	100/200	50	
	Greece	220/380	50			100/200	60	
	Hungary	230/400	50		Jordan	230/400	50	
	Iceland	220/380	50		Kazakhstan	220/380	50	
	Ireland, Northern	230/400	50		Korea, North	220/380	60	
	Ireland, Republic of	230/400	50		Korea, South	220/380	60	
	Italy	230/400	50		Kuwait	240/415	50	
	Latvia	220/380	50		Kyrgyzstan	220/380	50	
	Liechtenstein	230/400	50		Laos	230/400	50	
	Lithuania	220/380	50		Lebanon	230/400	50	
	Luxembourg	220/380	50		Malaysia	240/415	50	
	Macedonia	220/380	50		Mongolia	230/400	50	
	Malta	240/415	50		Myanmar	230/400	50	
	Moldova	220/380	50		Nepal	230/400	50	
	Netherlands	230/400	50		Oman	240/415	50	
	Norway	230/400	50		Pakistan	230/400	50	
	Poland	230/400	50		Philippines	220/380	60	
	Portugal	220/380	50		Qatar	240/415	50	
Romania	230/400	50	Saudi Arabia	220/380	60			
Russian Federation	230/400	50	Singapore	230/400	50			
Slovak Republic	230/400	50	Sri Lanka	230/400	50			
Slovenia, Republic of	220/380	50	Syrian Arab Republic	220/380	50			
Spain	230/400	50	Taiwan	110/220	60			
Sweden	230/400	50	Tajikistan	220/380	50			
Switzerland	230/400	50	Thailand	220/380	50			
Turkey	220/380	50	Turkmenistan	220/380	50			
Ukraine	220/380	50	United Arab Emirates	220/380	50			
United Kingdom	230/400	50	Uzbekistan	220/380	50			
Yugoslavia	220/380	50	Vietnam	220/380	50			
					127/220	50		
				Yemen, Republic of	220/380	50		
Africa	Algeria	230/400	50	America	Argentina	220/380	50	
	Angola	220/380	50		Bolivia	230/400	50	
	Botswana	230/400	50		Brazil	220/380	60	
	Cameroon	220/380	50			127/220	60	
	Congo, People's Rep. of	230/400	50		Canada	230/460	60	
	Egypt	220/380	50		Chile	230/400	50	
	Ethiopia	220/380	50		Colombia	110/220	60	
	Gabon	220/380	50		Costa Rica	120/240	60	
	Ghana	230/400	50		Cuba	220/380	60	
	Kenya	240/415	50			110/220	60	
	Ivory Coast	220/380	50		Dominican Republic	110/220	60	
	Liberia	120/240	60		Ecuador	127/220	60	
	Libya	230/400	50		El Salvador	115/230	60	
	Mali	220/380	50		Guatemala	120/240	60	
	Morocco	220/380	50		Honduras	110/220	60	
	Namibia	220/380	50		Mexico	127/220	60	
	Nigeria	240/415	50		Nicaragua	120/240	60	
	Senegal	230/400	50		Panama	120/240	60	
	South Africa	525	50		Paraguay	220/380	50	
	Tanzania	230/400	50		Peru	220/380	60	
	Tunisia	230/400	50		United States of America	120/240	60	
	Uganda	240/415	50		Uruguay	220/380	50	
	Zambia	230/400	50		Venezuela	120/240	60	
	Zimbabwe	220/380	50					
						Oceania		
						Australia	230/415	50
						New Zealand	230/400	50

Notes:

The present General Description is completed by the Technical Catalogues for d.c. motors codes:

-	P-NP series frames 80-200	code C-NP 80-200-E-09
-	NP series frames 225-450	code C-NP225-450-E-09
-	NP series frames 500-800	code C-NP500-800-E-08

It is necessary to consult all sections in order to obtain complete and correct information. Please ask these catalogues to SICMEMOTORI or download them from SICMEMOTORI web site www.sicmemotori.com.

Customers can determine whether a specific product is suitable for their needs and are thus responsible for the selection, use and results obtained by any product showed in this catalogue. The information contained in the present catalogue does not guarantee the characteristics for the use.

The products listed in this catalogue are exclusively designed and built for industrial purposes.

For particular cases in NON-industrial environments, or where other types of protection must be provided (for example against contact with children fingers, etc.), these guards or additional protections must be realized by the customer.

Any non-observance of the rules for installation, use and maintenance or any modification/tampering with the motor makes the guarantee rights invalid and exempts us from any responsibility.

All data and indications shown in this catalogue have to be considered only as a guideline.

Any use of the motor differently from the specifications indicated in this catalogue does not involve any liability for us as manufacturer.

SICMEMOTORI reserves the right to modify at any time and without notice the data, the technical characteristics, the dimensions, the weights and the illustrations.

SICMEMOTORI refuses all responsibility for direct or indirect damages caused by possible errors and/or omissions in the present catalogue.

The reproduction, even in part, of the present catalogue must be authorized in writing by SICMEMOTORI.

**WARNING**

The motors and the electrical devices feeding them are electrical components installed on machines and industrial systems subject to high voltage. During operation, these components can be dangerous since they are live and have non-insulated and rotating parts. Therefore, they can be extremely harmful to personnel and objects if the instructions for the installation, the use and the maintenance are not respected.

The motors are always supplied complete with the installation, use and maintenance instruction manual. It is necessary to read and understand all the information contained before proceeding to connect and to start up the installation.

If the above mentioned documentation is lacking, please request a copy to SICMEMOTORI.

CAUTION

All information, data, drawings given in this catalogue are of a purely indicative nature and may be changed without prior notice. SICMEMOTORI shall not be held responsible if the products illustrated herein are used outside their limits of the specifications given.



Sicme Motori Srl

Strada del Francese, 130 - 10156 Torino - Italy

Tel: +39-011-4076311 - Fax: +39-011-4500047/4076439

www.sicmemotori.com - sicmemotori@sicmemotori.com



Attention:

Data, performances, drawings are indicative and can be changed at any moment without prior notice.