

Technical Information

ELGO Magnetic Tapes

Incremental Magnetic Tapes for Linear Measuring Systems

1	Technical Data MB20-xx-10-1-R-x.....	2
1.1	Components	2
1.2	Handling	3
1.3	Identification	3
1.4	Dimensions.....	3
1.5	Technical Data Magnetic Tape.....	4
1.6	Technical Data Cover Tape	5
1.7	Resistance against Chemicals	6
2	Type Key Magnetic Tape	7
2.1	Available Versions Magnetic Tape	7
3	Mounting / Installation of the Magnetic Tape	8
3.1	Note for Gluing the Magnetic Tape	8
3.2	Cutting and Gluing	9
4	Accessories	10
4.1	Cover tape	10
4.2	Aluminum Guide Rail	10
4.3	Tape End Caps.....	11
5	Index.....	12

1 Technical Data MB20-xx-10-1-R-x

The magnetic tape contains the necessary digital information for linear length measurement by ELGO length measuring systems. Generally speaking, there is incremental and absolute measurement.

The incremental measuring systems contain scanning electronics which scans the alternating north and south poles on the encoded magnetic tape and generates a sine-cosine-signal (one signal per pole).

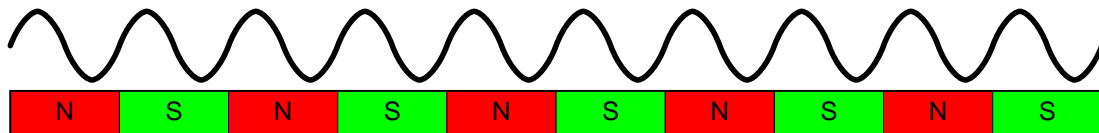

These signals are then interpolated electronically; the resolution of the measuring system is a result of the interpolation rate and the pole pitch.

1.1 Components

In the standard case, the magnetic tape is delivered as described below. It is installed by gluing it to the mounting surface.

The magnetic tape consists of 2 pre-assembled components (see fig. 1):

- A magnetized, flexible plastic tape (pos. 3), which is already fixed to a magnetically conductive steel tape (pos. 4) which serves as a carrier and is furnished with adhesive tape (pos. 5). The steel tape provides the necessary mechanical stability for the magnetic tape and also determines the coefficient of thermal expansion.
- A magnetically permeable cover tape (pos. 1), which protects the plastic tape from mechanical damage (not necessary for measurement) and is furnished with adhesive tape (pos. 2).

The composition of the tape and the scope of delivery may vary (see chapter 2.1).

The cover tape can be purchased separately (see chapter 4.1).

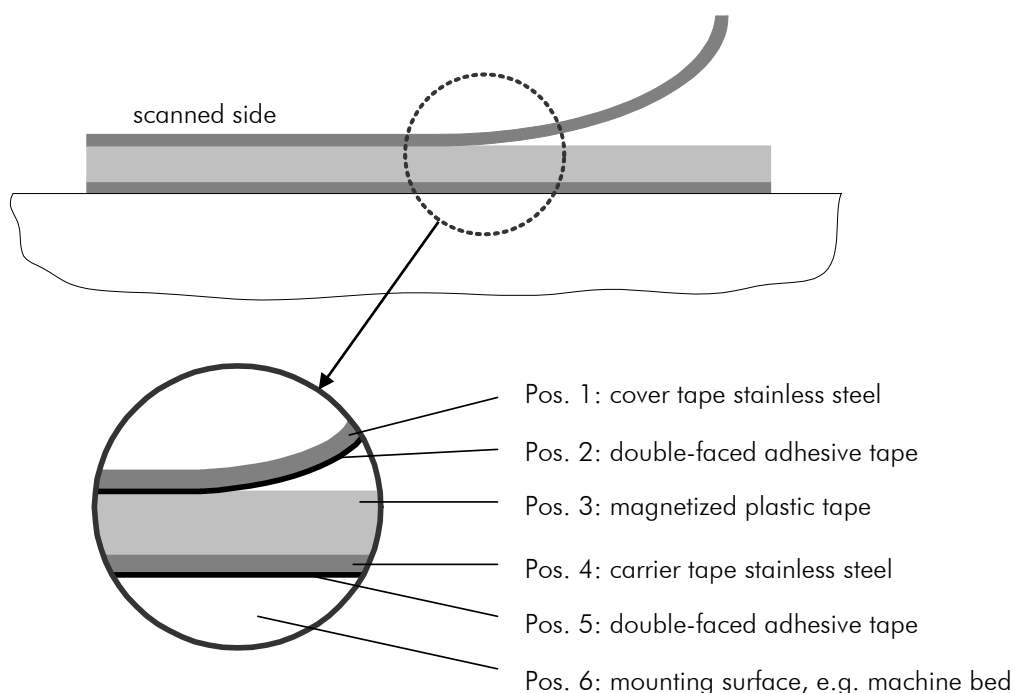

Figure 1 Components of the Magnetic Tape

1.2 Handling

In order to avoid strain on the magnetic tape, it must not be stretched, compressed or twisted. It should be stored with the magnetized plastic tape facing outwards (see fig. 2). The minimum bending radius must be observed (see chapter 1.5).

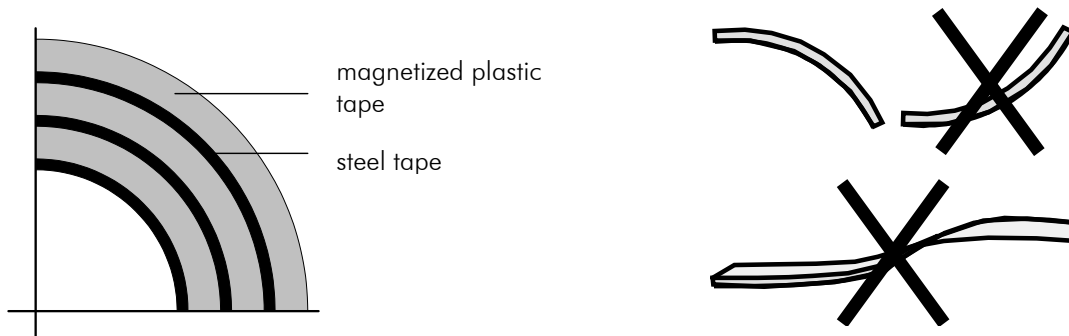
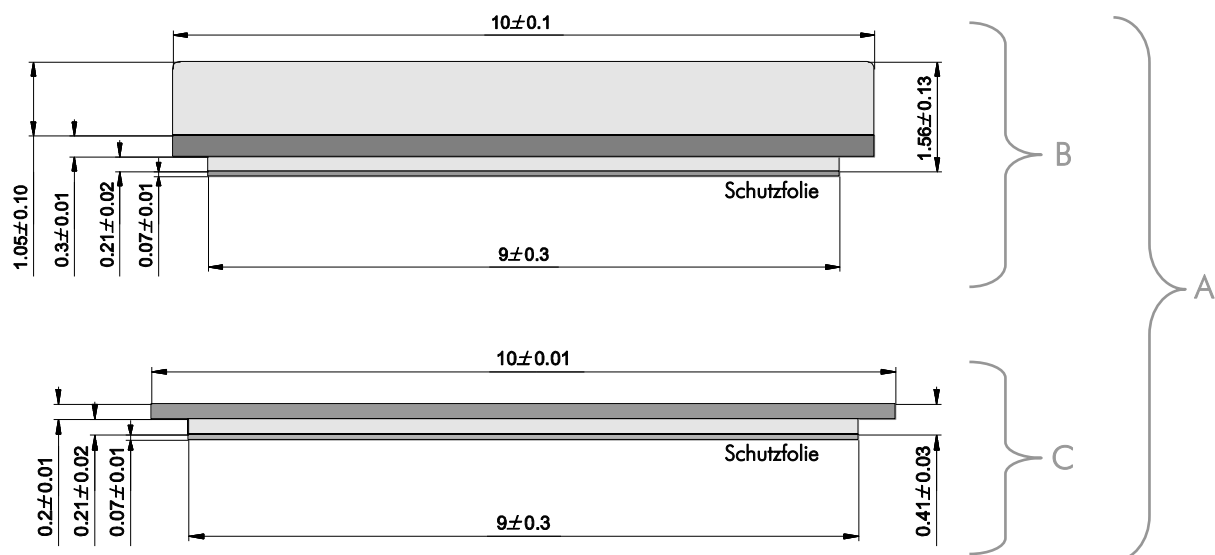

Figure 2 Handling

1.3 Identification

The magnetic tape is labeled with a continuous printing consisting of the tape type and the unique serial number. Only the scope of the delivery (see chapter 2, "Options") is not evident from the printing.

1.4 Dimensions



A) Magnetic tape set: **MB20-xx-10-1-R** (standard scope of delivery)

Consisting of the components:

B) Magnetic tape: **MB20-xx-10-1-R-C** (without cover tape)

C) cover tape: **SB-20-10-01-14404** (formerly AB10)

1.5 Technical Data Magnetic Tape

Magnetic Tape MB20-xx-10-1-R-x	
Encoding:	Incremental, single track system
Pole pitch:	2 mm / 2,5 mm / 5 mm (others on request)
Operating temperature installed:	-20°C ... +65°C (-20°C ... +80°C when using the tape without adhesive tape, options „B“ or „D“)
Storage temperature uninstalled:	Short-term: -10°C ... +60°C Medium-term: 0°C ... +40°C Long-term: +18°C (-20°C ... +80°C when using the tape without adhesive tape, options „B“ or „D“)
Gluing temperature:	+18°C ... +30°C
Relative humidity:	max. 95 %, non-condensing
Accurateness 20°C in mm:	+/- (0,025 + 0,02 x L[m]) (L = measuring length in meters)
Material carrier tape:	Precision strip 1.4310 / X10CrNi 18-8 (EN 10088-3)
Double-faced adhesive tape:	3M-9088 (observe instructions), others on request
Dimensions:	-> without adhesive tape: 10 mm (+/- 0,1) x 1,35 mm (+/- 0,11) -> with adhesive tape (excl. carrier): 10 mm (+/- 0,1) x 1,56 mm (+/- 0,13) -> with adhesive tape (incl. carrier): 10 mm (+/- 0,1) x 1,63 mm (+/- 0,14)
Length expansion coefficient:	$\alpha \approx 16 \times 10^{-6} \text{ 1/K}$
Thermal length expansion	$\Delta L[\text{m}] = L[\text{m}] \times \alpha[\text{1/K}] \times \Delta \vartheta[\text{K}]$ (L = tape length in meters, $\Delta \vartheta$ = relative temperature change)
Bending radius:	min. 150 mm
Available lengths:	32 m (up to 70m on request)
Weight magnetic tape:	ca. 62 g/m (incl. magnetic tape and cover tape)
Tape imprint:	ELGO standard, printing color black, digit height ≥ 5 mm
Influence of external magnets:	External magnetic fields must not exceed 64 mT (640 Oe; 52 kA/m on the surface of the magnetic tape as this could damage or destroy the code on the tape.
Protection class:	Carrier tape stainless steel

1.6 Technical Data Cover Tape

Cover tape SB-20-10-01-14404 (Formerly: AB10)	
Description:	Cover tape, width 10mm, furnished on one side with double-faced adhesive tape
Material:	Precision strip 1.4404 / X2CrNiMo 17-12-2 (EN 10088-3)
Length expansion coefficient:	$\alpha \approx 16 \times 10^{-6} \text{ 1/K}$
Thermal length expansion	$\Delta L[\text{m}] = L[\text{m}] \times \alpha[1/\text{K}] \times \Delta\vartheta[\text{K}]$ (L = tape length in meters, $\Delta\vartheta$ = relative temperature change)
Double-faced adhesive tape	3M-9088 (observe instructions), others on request
Dimensions:	-> without adhesive tape: 10 mm (+/- 0,1) x 0,20 mm (+/- 0,01) -> with adhesive tape (excl. carrier): 10 mm (+/- 0,1) x 0,41 mm (+/- 0,03) -> with adhesive tape (incl. carrier): 10 mm (+/- 0,1) x 0,48 mm (+/- 0,04)
Operating temperature installed:	-20°C ... +65°C
Storage temperature uninstalled:	Short-term: -10°C ... +60°C Medium-term: 0°...+40°C Long-term: +18°C
Gluing temperature:	+18°C ... +30°C
Relative humidity:	max. 95 %, non-condensing
Bending radius:	min. 150 mm
Available lengths:	32 m / 70 m (more on request)
Weight cover tape:	ca. 19 g/m (incl. adhesive tape and cover foil)
Protection class:	Cover tape stainless steel

1.7 Resistance against Chemicals

Chemicals, showing no or only small effects:

- | | | | |
|--------------------|-----------------|---------------|-----------------|
| - formic acid | - glycerol 93°C | - linseed oil | - soy beans oil |
| - cotton seed oil | - N-hexane | - lactic acid | |
| - formaldehyde 40% | - iso octane | - petroleum | |

Chemicals, showing small to medium effects:

- | | | | |
|-------------|-------------------|---------------------------------|---------------------|
| - acetone | - gasoline | - acetic acid 30% | - Olein acid |
| - acetylene | - steam | - acetic acid, pure acetic acid | - sea water |
| - ammonia | - acetic acid 20% | - isopropyl ether | - stearic acid 70°C |
| - anhydrous | - kerosene | | |

Chemicals, showing strong effects:

- | | | | |
|-------------------------------|-------------------------------|------------------------|-------------------|
| - benzene | - nitric acid 70% | - nitrobenzene | - lacquer solvent |
| - turpentine | - nitric acid, red, vitriolic | - carbon tetrachloride | - trichloroethane |
| - hydrochloric acid 37%, 93°C | | - tetrahydrofuran | - xylene |

2 Type Key Magnetic Tape

MB20-	AA-	BB-	C-	D-	E
<p>Designation: _____</p> <p>MB20 -> Incremental Magnetic Tape</p>					
<p>Pole Pitch: _____</p> <p>Pole Pitch in 100µm resolution, e.g.:</p> <p>20 = 2 mm pole pitch</p> <p>25 = 2.5 mm pole pitch</p> <p>50 = 5 mm pole pitch</p>					
<p>Tape Width: _____</p> <p>Tape width in mm, e.g.:</p> <p>02= 2mm / 05= 5mm / 10= 10mm / 20= 20mm</p>					
<p>Number of Tracks: _____</p> <p>Number of magnetic tracks:</p> <p>1 = Single-track system</p>					
<p>Tape Construction: _____</p> <p>R = Standard: Magnetic tape on carrier tape (with adhesive tape on rear side and enclosed cover tape)</p>					
<p>Options: _____</p> <p>B = Without adhesive tape on rear side</p> <p>C = without enclosed cover tape</p> <p>D = without adhesive tape and cover tape (options B+C)</p>					

2.1 Available Versions Magnetic Tape

Order Designation	Description
MB20-xx-10-1-R	Magnetic tape standard with cover tape and adhesive tape
MB20-xx-10-1-R-B	Without adhesive tape on rear side / with enclosed cover tape
MB20-xx-10-1-R-C	With adhesive tape on rear side / without cover tape
MB20-xx-10-1-R-D	Without adhesive tape on rear side / without cover tape

Available lengths: 0.5 m ... 70 m
 Order example: MB20-25-10-1-R / L=1,5m

	<p>NOTE!</p> <p>For technical reasons our sensors cannot measure to the very end of the magnetic tape. Therefore, it is advisable to keep a distance of 50mm to the cutting line.</p> <p style="text-align: center;">→ TAPE LENGTH = MEASURING LENGTH + 100 mm ←</p>
---	---

3 Mounting / Installation of the Magnetic Tape



NOTE External Magnetic Fields

The magnetic tape must not be influenced by external magnetic fields! The magnetic tape must not come into direct contact with other magnetic fields (e.g. permanent magnets, magnetic clamps, electromagnets, magnetic stands)! This may cause irreparable damage, which will compromise the measuring accuracy or even the functioning.

3.1 Note for Gluing the Magnetic Tape

The provided adhesive tape is coated with a modified acrylate adhesive and stick well on clean, dry smooth surfaces. They are characterized by their high initial adhesion and good adhesion on high and low-energy surfaces (e.g. PE, PP), by a high shear resistance and peel strength, and by their high resistance against humidity, UV and ageing.

The higher the pollution on the site of installation, the better the surface should be prepared.



NOTE Surface Preparation

In order to guarantee optimal adhesion, all antiadhesive contamination (e.g. oil, grease, dust, separating agents) has to be removed using solvents with residue-free evaporation. Suitable agents are ketones or alcohols. Typical solvents for cleaning the surface are a 50/50 isopropyl alcohol/water mixture or heptane. Those agents are offered by Loctite and 3M among others as surface cleaners. When using solvents, always observe the manufacturer instructions! If the surface is copper, brass etc, it should be sealed to avoid oxidation.

NOTE Contact Pressure

The strength of the adhesion is directly dependent on the contact the adhesive can form with the surface. Therefore it is important to use as much pressure as possible when gluing the tape, possibly by using aids such as draw rolls. The optimum contact pressure is 4...5 kg/cm².

NOTE Gluing temperature

The best gluing temperature is between +18°C and +30°C. It is not recommended to glue the tape on surfaces that are colder than +10°C as the adhesive becomes too hard and the initial adhesion decreases. If the tape is glued on correctly, it will hold even in temperatures below 0°C. The final adhesive strength is normally reached after 72 hours (at +21°C).

3.2 Cutting and Gluing

Before starting the gluing process, both the magnetic and the cover tape have to be cut to the required length:

Length magnetic tape = measuring length + 100 mm

Length cover tape = measuring length + 100 mm + overlap*



NOTE

When unprotected, the cover tape may peel off!

Therefore:

Use tape end caps or let the cover tape (see 4.1) overlap* the end of the magnetic tape and fix it with a screw.

Preferably the magnetic tape should be glued close to an edge or into a groove, which should be deep enough to embed the magnetic tape and the cover tape.

The tape must be glued smoothly on the surface. The measuring accuracy decreases if the tape is not even!

Before gluing the magnetic tape and the cover tape onto the surface, they should be left lying on the mounting surface for ca. 30 minutes so that the temperature matches. This prevents strain in the tape due to thermal expansion.

Mounting steps:

1. Thoroughly clean surface (see chapter 3.1)
2. Let magnetic tape and cover tape adjust their temperature
3. Remove protection foil of adhesive tape on magnetic tape
4. Glue magnetic tape using great pressure
5. Thoroughly clean surface of magnetic tape
6. Remove protection foil of adhesive tape on cover tape
7. Glue cover tape using great pressure
8. Safeguard the ends of the cover tape against peeling off (using end caps see chapter 4.3)



TIP

When gluing long strips of magnetic tape, remove only part of the protection foil to fix the tape in the desired position.

You can then pull out the rest of the foil sideways while simultaneously applying a steady pressure to the tape.



NOTE

Once the tape is glued onto a surface it cannot be used again. It will be destroyed when it is removed!

4 Accessories

4.1 Cover tape

For drawing see chapter 1.4.

Order designation	Description
SB-20-10-01-14404 (formerly AB10)	Cover tape, width 10mm, double-faced adhesive tape on one side

4.2 Aluminum Guide Rail

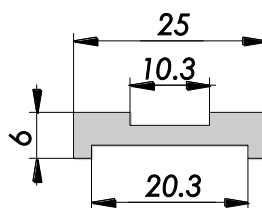

Order Designation	Description
FS-20.20-xxxx (xxxx = length in mm)	Aluminum profile rail with glued-on magnetic tape MB20-20-10-1-R
FS-20.25-xxxx (xxxx = length in mm)	Aluminum profile rail with glued-on magnetic tape MB20-25-10-1-R
FS-20.50-xxxx (xxxx = length in mm)	Aluminum profile rail with glued-on magnetic tape MB20-50-10-1-R
FS-xxxx (xxxx = length in mm)	Aluminum profile rail with 2 grooves for embedding a 10mm or 20mm wide magnetic tape. Without magnetic tape!

The guide rails are available up to a maximum length of 200mm.

4.3 Tape End Caps

The tape end caps provide ideal protection against the magnetic tape or the cover tape peeling off (see also chapter 3.2).

Also, the danger of injuries due to sharp edges is minimized.

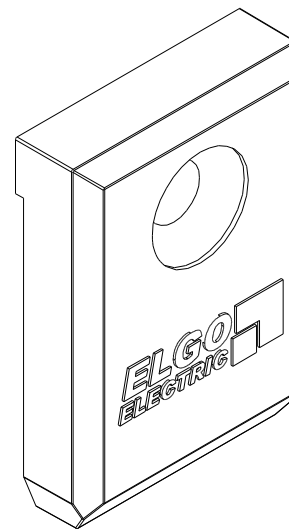
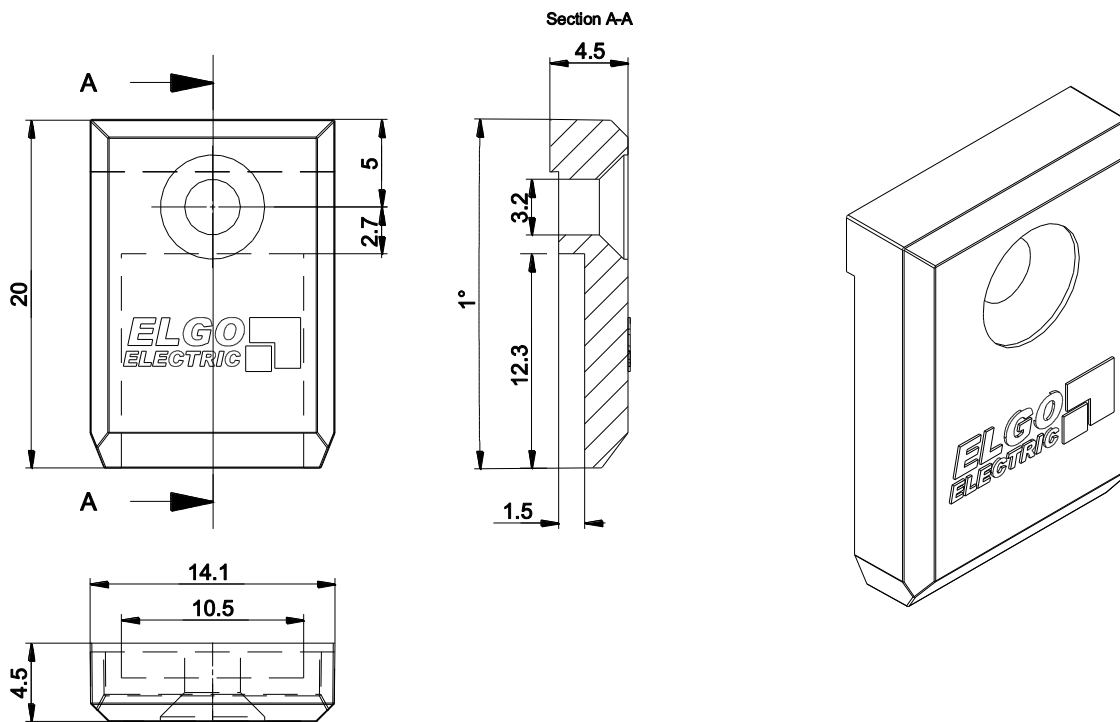
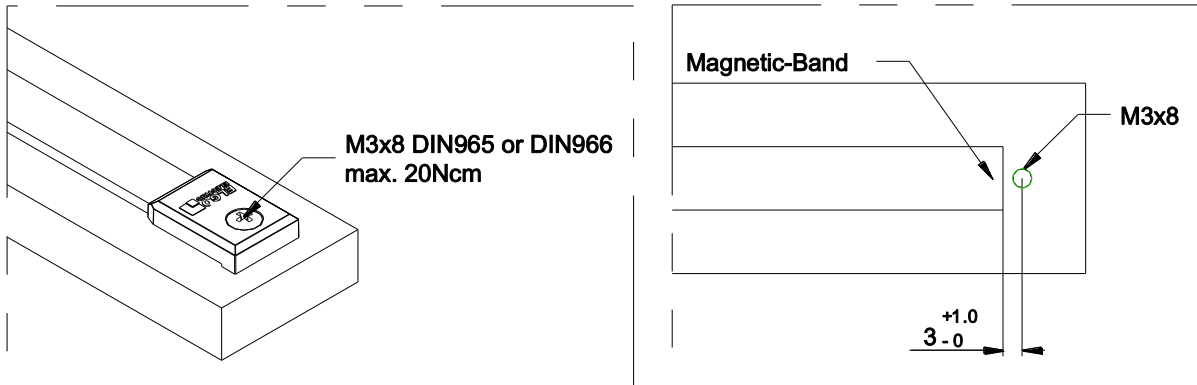

Order Designation	Description
MB Endkappe 10 mm / Einzeln	Single tape end cap
MB Endkappe 10 mm / SET	Set consisting of 2 end caps and two flat head screws Philips M3x8 in minigrip bag

5 Index

Accessories	10	Installation	8
Adhesive Tape	8	Magnetic Tape	2
Aluminum Guide Rail	10	Tape End Caps	11
Cover Tape	10	Technical Data	2
Dimensions Magnetic Tape	3	Type Key	7
Identification	3	Versions Magnetic Tape	7

