



Power analyzer

CVM-C10



INSTRUCTION MANUAL

(M001B01-03-19C)







## SAFETY PRECAUTIONS

Follow the warnings described in this manual with the symbols shown below.

	<p><b>DANGER</b> Warns of a risk, which could result in personal injury or material damage.</p>
---	---

	<p><b>ATTENTION</b> Indicates that special attention should be paid to a specific point.</p>
---	--

**If you must handle the unit for its installation, start-up or maintenance, the following should be taken into consideration:**

	<p>Incorrect handling or installation of the unit may result in injury to personnel as well as damage to the unit. In particular, handling with voltages applied may result in electric shock, which may cause death or serious injury to personnel. Defective installation or maintenance may also lead to the risk of fire. Read the manual carefully prior to connecting the unit. Follow all installation and maintenance instructions throughout the unit's working life. Pay special attention to the installation standards of the National Electrical Code.</p>
---	---

	<p><b>Refer to the instruction manual before using the unit</b> In this manual, if the instructions marked with this symbol are not respected or carried out correctly, it can result in injury or damage to the unit and /or installations.</p>
---	--

CIRCUTOR, SA reserves the right to modify features or the product manual without prior notification.

## DISCLAIMER

**CIRCUTOR, SA** reserves the right to make modifications to the device or the unit specifications set out in this instruction manual without prior notice.

**CIRCUTOR, SA** on its web site, supplies its customers with the latest versions of the device specifications and the most updated manuals.

[www.circutor.com](http://www.circutor.com)



## CONTENTS

SAFETY PRECAUTIONS .....	3
DISCLAIMER .....	3
CONTENTS .....	4
REVISION LOG.....	6
1.- VERIFICATION UPON RECEPTION .....	7
2.- PRODUCT DESCRIPTION .....	7
3.- DEVICE INSTALLATION .....	9
3.1.- PRIOR RECOMMENDATIONS.....	9
3.2.- INSTALLATION .....	10
3.3.- CVM-C10-FLEX: ROGOWSKI SENSORS.....	10
3.4.- DEVICE TERMINALS .....	12
3.4.1.- LIST OF TERMINALS, CVM-C10-ITF, CVM-C10-MC AND CVM-C10-mV MODELS .....	12
3.4.2.- LIST OF TERMINALS, CVM-C10-ITF-IN AND CVM-C10-MC-IN MODELS.....	13
3.4.3.- LIST OF TERMINALS, CVM-C10-FLEX MODEL .....	14
3.5.- CONNECTION DIAGRAM .....	15
3.5.1.- MEASURING THREE-PHASE NETWORKS WITH A 4-WIRE CONNECTION, CVM-C10-ITF AND CVM-C10-mV MODEL .....	15
3.5.2.- MEASURING THREE-PHASE NETWORKS WITH A 4-WIRE CONNECTION, CVM-C10-ITF-IN MODEL .....	16
3.5.3.- MEASURING THREE-PHASE NETWORKS WITH A 4-WIRE CONNECTION CVM-C10-MC MODEL .....	17
3.5.4.- MEASURING THREE-PHASE NETWORKS WITH A 4-WIRE CONNECTION CVM-C10-MC-IN MODEL .....	18
3.5.5.- MEASURING THREE-PHASE NETWORKS WITH A 4-WIRE CONNECTION, CVM-C10-FLEX MODEL .....	19
3.5.6.- MEASURING THREE-PHASE NETWORKS WITH A 3-WIRE CONNECTION, CVM-C10-ITF AND CVM-C10-mV MODEL .....	20
3.5.7.- MEASURING THREE-PHASE NETWORKS WITH A 3-WIRE CONNECTION, CVM-C10-MC MODEL .....	21
3.5.8.- MEASURING THREE-PHASE NETWORKS WITH A 3-WIRE CONNECTION, CVM-C10-FLEX MODEL .....	22
3.5.9.- MEASURING THREE-PHASE NETWORKS WITH A 3-WIRE CONNECTION AND TRANSFORMERS WITH AN ARON CONNECTION, CVM-C10-ITF AND CVM-C10-MC MODELS .....	23
3.5.10.- MEASURING TWO-PHASE NETWORKS WITH A 3-WIRE CONNECTION, CVM-C10-ITF, CVM-C10-MC AND CVM-C10-mV MODELS .....	24
3.5.11.- MEASURING TWO-PHASE NETWORKS WITH A 3-WIRE CONNECTION, CVM-C10-ITF-IN AND CVM-C10-MC-IN MODELS.....	25
3.5.12.- MEASURING TWO-PHASE NETWORKS WITH A 3-WIRE CONNECTION, CVM-C10-FLEX MODEL .....	26
3.5.13.- MEASURING SINGLE-PHASE NETWORKS, PHASE TO PHASE, WITH A 2-WIRE CONNECTION, CVM-C10-ITF, CVM-C10-MC AND CVM-C10-mV MODELS .....	27
3.5.14.- MEASURING SINGLE-PHASE NETWORKS, PHASE TO PHASE, WITH A 2-WIRE CONNECTION, CVM-C10-FLEX MODEL .....	28
3.5.15.- MEASURING SINGLE-PHASE NETWORKS, PHASE TO NEUTRAL, WITH A 2-WIRE CONNECTION, CVM-C10-ITF, CVM-C10-MC AND CVM-C10-mV MODELS.....	29
3.5.16.- MEASURING SINGLE-PHASE NETWORKS, PHASE TO NEUTRAL, WITH A 2-WIRE CONNECTION, CVM-C10-FLEX MODEL.....	30
4.- OPERATION .....	31
4.1.- MEASURING PARAMETERS .....	32
4.2.- KEYBOARD FUNCTIONS.....	33
4.3.- DISPLAY .....	35
4.3.1. cos $\varphi$ - PF (POWER FACTOR) BAR .....	35
4.3.2. ANALOGUE BAR.....	36
4.3.3. OTHER SYMBOLS ON THE DISPLAY .....	36
4.4.- LED INDICATORS .....	37
4.5.- OPERATION PROFILES .....	37
4.5.1. ANALYZER PROFILE.....	37
4.5.2. e <sup>3</sup> PROFILE.....	41
4.5.3. USER .....	44

4.6.- HARMONICS .....	44
4.7.- INPUTS .....	45
4.8.- OUTPUTS .....	45
4.9.- PROGRAMMING .....	46
4.9.1. PRIMARY VOLTAGE .....	47
4.9.2. SECONDARY VOLTAGE.....	48
4.9.3. PRIMARY CURRENT .....	48
4.9.4. SECONDARY CURRENT ( MODEL CVM-C10-ITF) .....	49
4.9.5. PRIMARY NEUTRAL CURRENT ( MODELS: CVM-C10-ITF-IN AND CVM-C10-MC-IN).....	49
4.9.6. SECUNDARY NEUTRAL CURRENT (MODEL CVM-C10-ITF-IN) .....	50
4.9.7. NUMBER OF QUADRANTS .....	50
4.9.8. MEASUREMENT CONVENTION .....	50
4.9.9. TYPE OF INSTALLATION .....	51
4.9.10. MAXIMUM DEMAND INTEGRATION PERIOD.....	51
4.9.11. DELETING MAXIMUM DEMAND.....	52
4.9.12. SELECTING THE OPERATION PROFILE.....	52
4.9.13. BACKLIGHT, TURNING ON THE BACKLIT DISPLAY .....	54
4.9.14. SELECTING THE $\cos \varphi$ - PF BAR ON THE DISPLAY.....	54
4.9.15. DELETING MAXIMUM AND MINIMUM VALUES .....	55
4.9.16. DELETING ENERGY VALUES.....	55
4.9.17. SELECTING THE RANGE OF ENERGIES .....	55
4.9.18. ACTIVATING THE HARMONICS DISPLAY SCREEN. ....	56
4.9.19. $\text{kgCO}_2$ CARBON EMISSION RATIO OF GENERATED ENERGY.....	56
4.9.20. $\text{kgCO}_2$ CARBON EMISSION RATIO OF CONSUMED ENERGY.....	57
4.9.21. COST RATIO OF GENERATED ENERGY.....	57
4.9.22. COST RATIO OF CONSUMED ENERGY .....	58
4.9.23. PROGRAMMING ALARM 1 (RELAY 1) .....	59
4.9.24. PROGRAMMING ALARM 2 (RELAY 2) .....	64
4.9.25. PROGRAMMING ALARM 3 (DIGITAL OUTPUT T1).....	64
4.9.26. PROGRAMMING ALARM 4 (DIGITAL OUTPUT T2).....	66
4.9.27. OPERATING MODE OF DIGITAL INPUT 1 .....	67
4.9.28. OPERATING MODE OF DIGITAL INPUT 2 .....	67
4.9.29. RS-485 COMMUNICATIONS: PROTOCOL .....	67
4.9.30. LOCKING THE PROGRAMMING .....	71
4.10.- COMMUNICATIONS.....	73
4.10.1. CONNECTIONS.....	73
4.10.2. PROTOCOL .....	74
4.10.3. MODBUS COMMANDS.....	75
4.10.4. BACnet PROTOCOL.....	85
4.10.5. MAPA PICS.....	86
5.- TECHNICAL FEATURES .....	89
6.- MAINTENANCE AND TECHNICAL SERVICE.....	93
7.- GUARANTEE.....	93
8.- CE CERTIFICATE.....	94

**REVISION LOG**
**Table 1: Revision log.**

Date	Revision	Description
04/14	M001B01-03-14A	Initial Version
06/14	M001B01-03-14B	Changes in the following sections: 3.4 - 4.9 - 4.10 - 5
06/14	M001B01-03-14C	Changes in the following sections: 4.9.5 - 4.9.6 - 4.10.2.1
11/14	M001B01-03-14D	Changes in the following sections: 4.9.21 - 4.9.23 - 4.10.2 - 4.10.3 - 5
11/14	M001B01-03-14E	Changes in the following sections: 3.3.2 - 3.4.2 - 3.4.8 - 4.5 - 4.9 - 4.10.3.1
01/15	M001B01-03-15A	Changes in the following sections: 2 - 3.3.- 3.4- 4.1- 4.9.4 -4.9.28 - 4.10 - 4.10.3.2 - 5
10/15	M001B01-03-15B	Changes in the following sections: 4.2 - 4.5.1 - 4.5.3 - 4.6 - 4.7 - 4.9 - 4.9.1 - 4.9.9 - 4.9.12 - 4.9.22.- 4.9.24 - 4.10.5
12/15	M001B01-03-15C	Changes in the following sections: 3.2.- 4.- 4.3.1.- 4.9.- 4.10.3.6. - 4.10.4.- 4.10.5.- 5.
07/16	M001B01-03-16A	Changes in the following sections: 4.9.23
02/17	M001B01-03-17A	Changes in the following sections: 2.- 3.3. - 3.4. - 3.5. - 4.7. - 4.8. - 4.9.- 4.10.3.6. - 4.10.3.7 - 5
07/17	M001B01-03-17B	Changes in the following sections: 5. - 8.
10/17	M001B01-03-17C	Changes in the following sections: 3.3 - 5.
06/18	M001B01-03-18A	Changes in the following sections: 2. - 3.4.2. - 3.5. - 4.1. - 4.5.1. - 4.5.3. - 4.8. - 4.9.5. - 4.9.23. - 4.10.3.1. - 4.10.3.7.2. - 4.9.25. - 4.9.26.- 4.10.3.7.13. - 5.
01/19	M001B01-03-19A	Changes in the following sections: 3.3.
02/19	M001B01-03-19B	Changes in the following sections: 5.
05/19	M001B01-03-19C	Changes in the following sections: 4.5.1. - 4.10.3.7.

**Note :** Devices images are for illustrative purposes only and may differ from the actual device.

## 1.- VERIFICATION UPON RECEPTION

Check the following points when you receive the device:

- a) The device meets the specifications described in your order.
- b) The device has not suffered any damage during transport.
- c) Perform an external visual inspection of the device prior to switching it on.
- d) Check that it has been delivered with the following:
  - An installation guide,
  - 2 Retainers used to attach the device,
  - 5 connectors.



If any problem is noticed upon reception, immediately contact the transport company and/or **CIRCUTOR's** after-sales service.

## 2.- PRODUCT DESCRIPTION

The **CVM-C10** device measures, calculates and displays the main electrical parameters of the following networks: single-phase, two-phase, with and without neutral, balanced three-phase, with ARON measurements or unbalanced. The measurement will be taken in RMS with the three AC voltage inputs and three current inputs.

There are 6 versions of the device, depending on the type of current input:

- ✓ **CVM-C10-ITF**, indirect current measurement with /5A or /1A transformers.
- ✓ **CVM-C10-ITF-IN**, indirect current measurement with /5A or /1A transformers and an input to measure the neutral current.
- ✓ **CVM-C10-MC**, indirect current measurement with efficient transformers of the MC1 and MC3 series.
- ✓ **CVM-C10-MC-IN**, indirect current measurement with efficient transformers of the MC1 and MC3 series and an input to measure the neutral current.
- ✓ **CVM-C10-mV** indirect current measurement with /0.333V transformers.
- ✓ **CVM-C10-FLEX** current measurement through Rogowski sensors.



The device features:

- **3 keys** that allow you to browse between the various screens and program the device.
- **3 indicator LEDs**: CPU, ALARM and KEY.
- **LCD display**, displays all parameters,

- **2 digital inputs**, used to select the tariff or detect the logic state of external signals.
- **2 digital outputs**, fully programmable.  
(Not available in the **CVM-C10-ITF-IN**, **CVM-C10-MC-IN** and **CVM-C10-FLEX** models)
- **2 alarm relays**, fully programmable (Not available in the **CVM-C10-FLEX** model)
- **RS-485** Communications, with two serial protocols: **MODBUS RTU**© and **BACnet**.



## 3.- DEVICE INSTALLATION

### 3.1.- PRIOR RECOMMENDATIONS



In order to use the device safely, it is critical that individuals who handle it follow the safety measures set out in the standards of the country where it is being used, use the necessary personal protective equipment, and pay attention to the various warnings indicated in this instruction manual.

The **CVM-C10** device must be installed by authorised and qualified staff.

The power supply plug must be disconnected and measuring systems switched off before handling, altering the connections or replacing the device. It is dangerous to handle the device while it is powered.

Also, it is critical to keep the cables in perfect condition in order to avoid accidents, personal injury and damage to installations.

The manufacturer of the device is not responsible for any damage resulting from failure by the user or installer to heed the warnings and/or recommendations set out in this manual, nor for damage resulting from the use of non-original products or accessories or those made by other manufacturers.

If an anomaly or malfunction is detected in the device, do not use it to take any measurements.

Inspect the work area before taking any measurements. Do not take measurements in dangerous areas or where there is a risk of explosion.



Disconnect the device from the power supply (device and measuring system power supply) before maintaining, repairing or handling the device's connections. Please contact the after-sales service if you suspect that there is an operational fault in the device.

### 3.2.- INSTALLATION

The device will be installed on a panel ( $92^{+0.8} \times 92^{+0.8}$  mm panel drill hole, in compliance with DIN 43700). All connections are located inside the electric panel.

	Terminals, opening covers or removing elements can expose parts that are hazardous to the touch while the device is powered. Do not use the device until it is fully installed.
---	---

The device must be connected to a power circuit that is protected with gl (IEC 269) or M type fuses with a rating of 0.5 to 2 A. It must be fitted with a circuit breaker or equivalent device, in order to be able to disconnect the device from the power supply network.

The power and voltage measuring circuit must be connected with cables that have a minimum cross-section of 1mm<sup>2</sup>.

The secondary line of the current transformer will have a minimum cross-section of 2.5 mm<sup>2</sup>.

The temperature rating of insulation of wires connected to the device will be at minimum 62°C.

### 3.3.- CVM-C10-FLEX: ROGOWSKI SENSORS

The **CVM-C10-FLEX** model measures currents using flexible sensors, based on the Rogowski coil principle.

The flexibility of the sensor allows it to measure an alternating current irrespective of the position of the conductor.

**CIRCUTOR** has a Rogowski sensor model that can be used with the **CVM-C10-FLEX: FLEX-MAG**.

**Table 3** shows the connection of the sensors and **Table 2** the maximum position error.

**Note:** For more information, consult the corresponding sensor guide.

**Table 2:Position error.**

Position	Error
	± 1%
B	A ± 3%

Table 3: Probe cable terminal connections

Probe cable terminal connections	
<b>FLEX-MAG</b>	
	
<b>Black :</b> Shield (SHLD)	
<b>Blue:</b> Common (C)	
<b>Green:</b> Measuring channel (L1, L2, L3, N)	

**3.4.- DEVICE TERMINALS**

**3.4.1.- LIST OF TERMINALS, CVM-C10-ITF, CVM-C10-MC AND CVM-C10-mV MODELS**

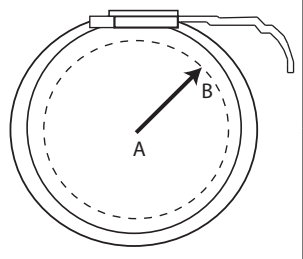
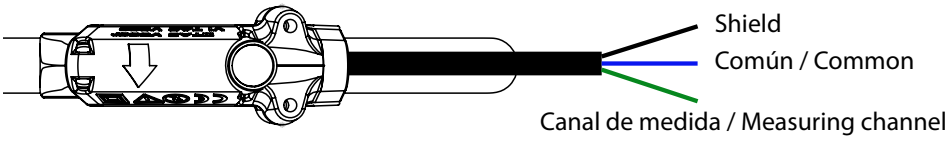
**Table 4:List of terminals of the CVM-C10-ITF, CVM-C10-MC and CVM-C10-mV.**

Device terminals	
<b>1 : A1</b> Auxiliary power supply.	<b>13: I2</b> , digital input 2 / tariff selection
<b>2: A2</b> Auxiliary power supply.	<b>14: V<sub>L1</sub></b> , Voltage input L1
<b>3: Rc</b> , Common relay output	<b>15: V<sub>L2</sub></b> , Voltage input L2
<b>4: R2</b> , Relay output 2	<b>16: V<sub>L3</sub></b> , Voltage input L3
<b>5: R1</b> , Relay output 1	<b>17: N</b> , Neutral
<b>6: CT</b> , Common digital output.	<b>18: S<sub>1</sub></b> , Current input L1
<b>7: T2</b> , Digital output 2	<b>19: S<sub>2</sub></b> , Current input L1
<b>8: T1</b> , Digital output 1	<b>20: S<sub>1</sub></b> , Current input L2
<b>9: A(+)</b> , RS485	<b>21: S<sub>2</sub></b> , Current input L2
<b>10: B(-)</b> , RS485	<b>22: S<sub>1</sub></b> , Current input L3
<b>11: GND</b> , for RS485 and digital inputs	<b>23: S<sub>2</sub></b> , Current input L3
<b>12: I1</b> , digital input 1 / tariff selection	

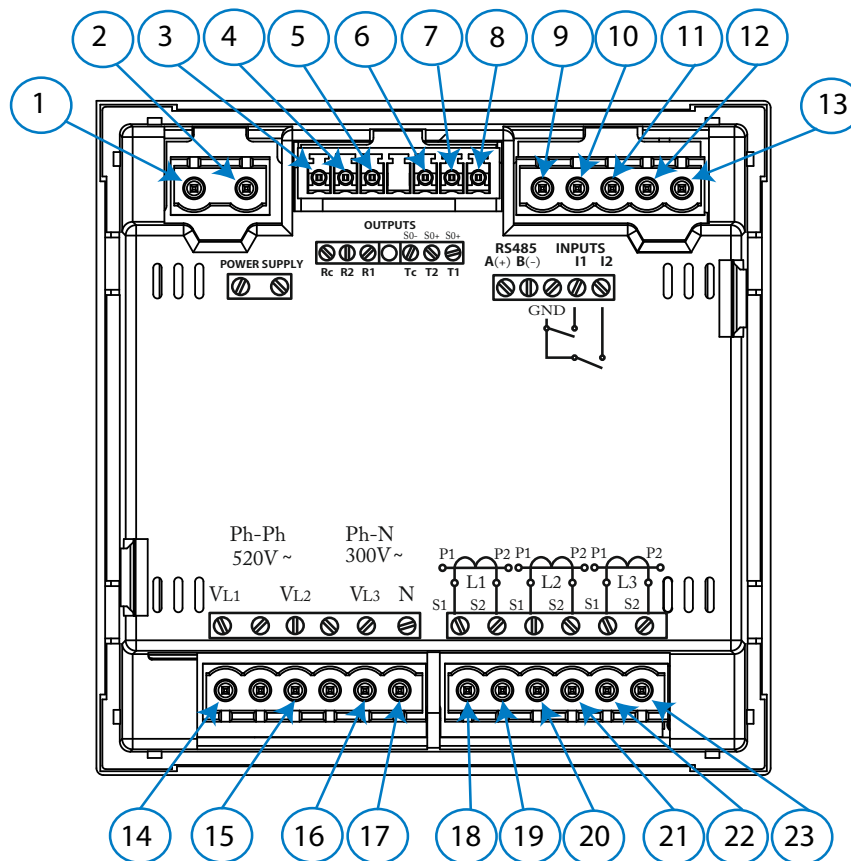

**Figure 1:Terminals of the CVM-C10-ITF, CVM-C10-MC and CVM-C10-mV.**

### 3.4.2.- LIST OF TERMINALS, CVM-C10-ITF-IN AND CVM-C10-MC-IN MODELS.

Table 5:List of terminals of the CVM-C10-ITF-IN and CVM-C10-MC-IN.

Device terminals	
1 : A1 Auxiliary power supply.	12: I2, digital input 2 / tariff selection
2: A2 Auxiliary power supply.	13: V <sub>L1</sub> , Voltage input L1
3: Rc, Common relay output	14: V <sub>L2</sub> , Voltage input L2
4: R2, Relay output 2	15: V <sub>L3</sub> , Voltage input L3
5: R1, Relay output 1	16: N, Neutral
6: S2, Neutral current input	17: S1, Current input L1
7: S1, Neutral current input	18: S2, Current input L1
8: A(+), RS485	19: S1, Current input L2
9: B(-), RS485	20: S2, Current input L2
10: GND, for RS485 and digital inputs	21: S1, Current input L3
11: I1, digital input 1 / tariff selection	22: S <sub>2</sub> , Current input L3

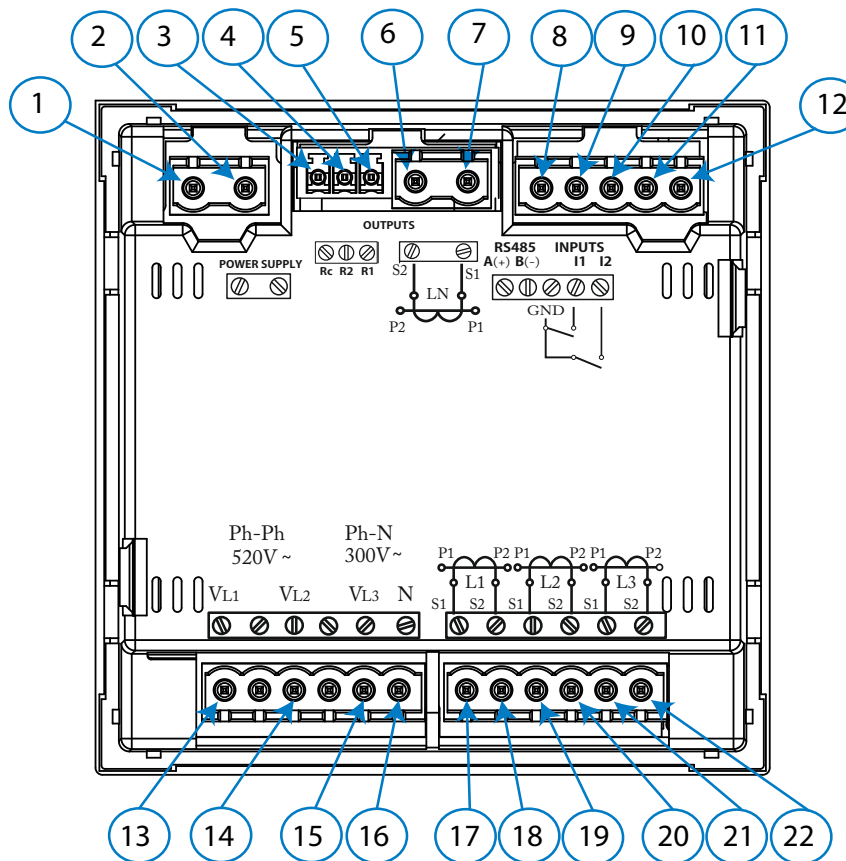
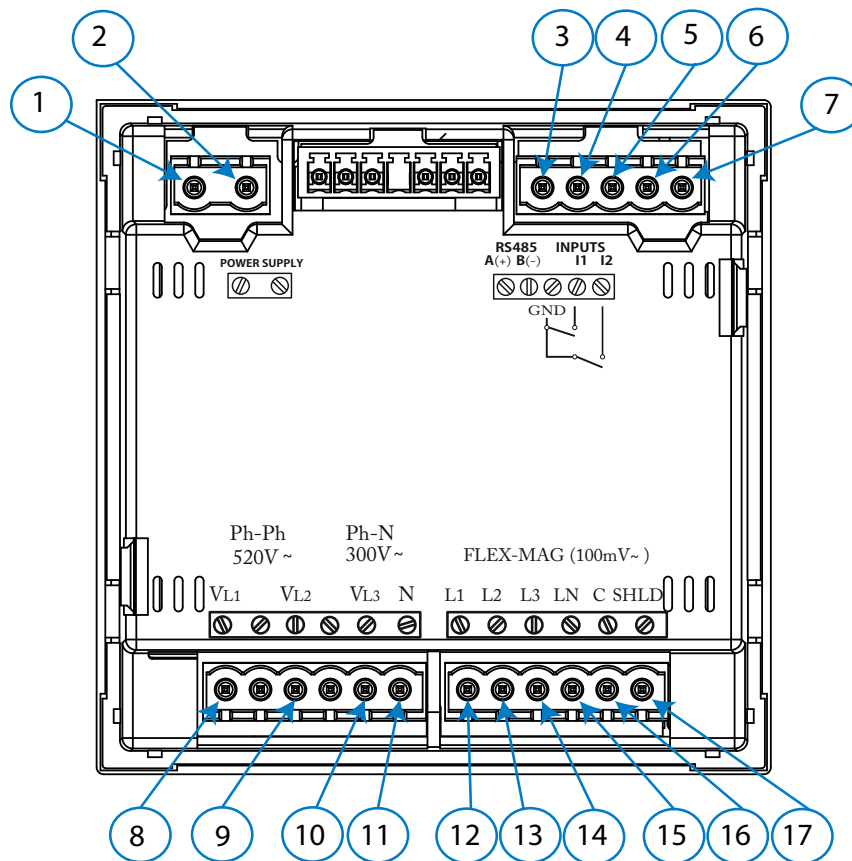

Figure 2:Terminals of the CVM-C10-ITF-IN and CVM-C10-MC-IN.

**3.4.3.- LIST OF TERMINALS, CVM-C10-FLEX MODEL**

**Table 6:List of terminals of the CVM-C10-FLEX.**

Device terminals	
1 : A1 Auxiliary power supply.	10: V <sub>L3</sub> , Voltage input L3
2: A2 Auxiliary power supply.	11: N, Neutral
3: A(+), RS485	12: L1, Current input L1
4: B(-), RS485	13: L2, Current input L2
5: GND, for RS485 and digital inputs.	14: L3, Current input L3
6: I1, digital input 1 / selection rate.	15: LN, Current input LN
7: I2, digital input 2 / selection rate.	16: C, Common for current inputs
8: V <sub>L1</sub> , Voltage input L1	17: SHLD, GND for current inputs
9: V <sub>L2</sub> , Voltage input L2	



**Figure 3:Terminals of the CVM-C10-FLEX.**

### 3.5.- CONNECTION DIAGRAM

#### 3.5.1.- MEASURING THREE-PHASE NETWORKS WITH A 4-WIRE CONNECTION, CVM-C10-ITF AND CVM-C10-mV MODEL.

Measurement system: *4-3Ph*

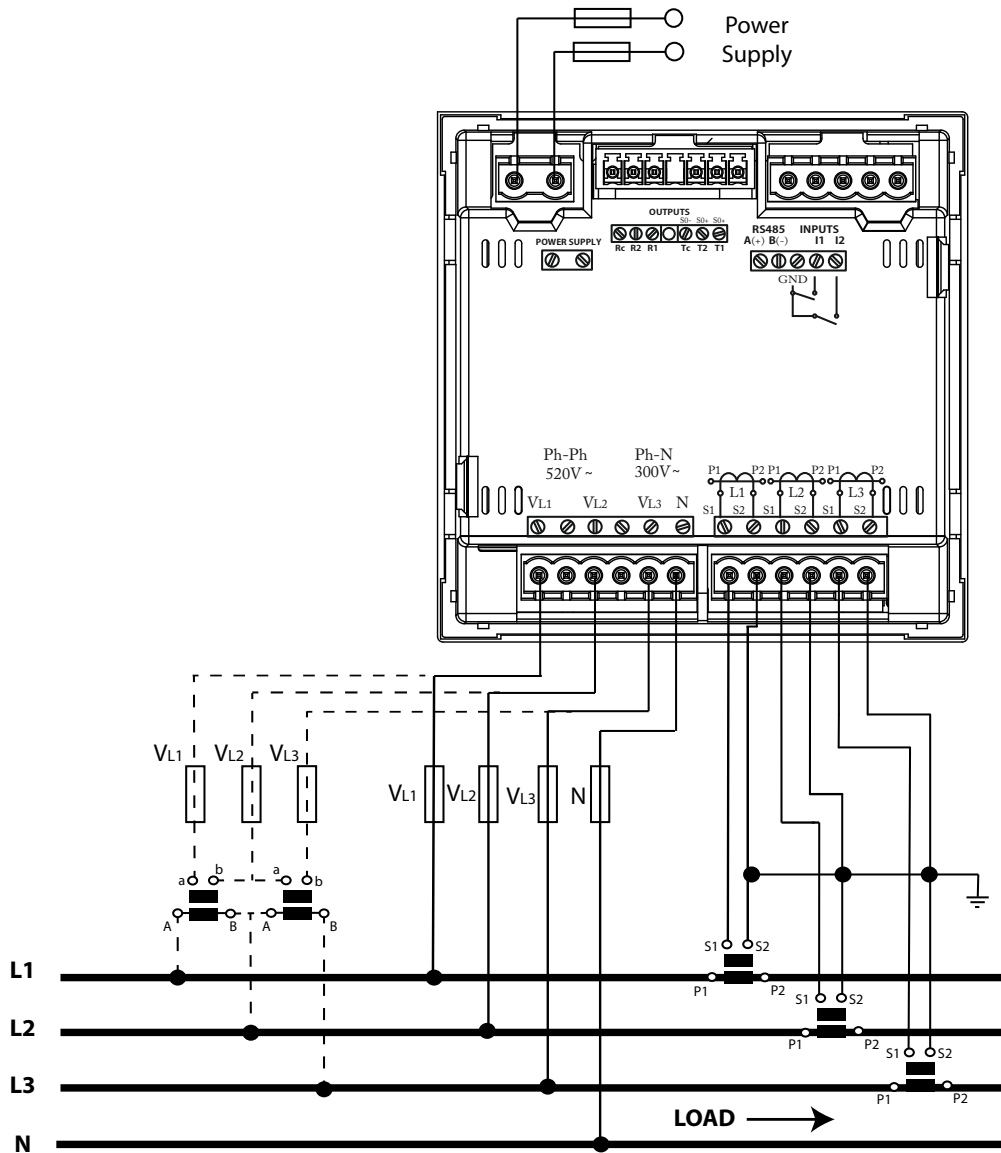

Figure 4: Three-Phase measuring with a 4-wire connection, CVM-C10-ITF and CVM-C10-mV model.

**3.5.2.- MEASURING THREE-PHASE NETWORKS WITH A 4-WIRE CONNECTION, CVM-C10-ITF-IN MODEL.**

Measurement system: **4-3Ph**

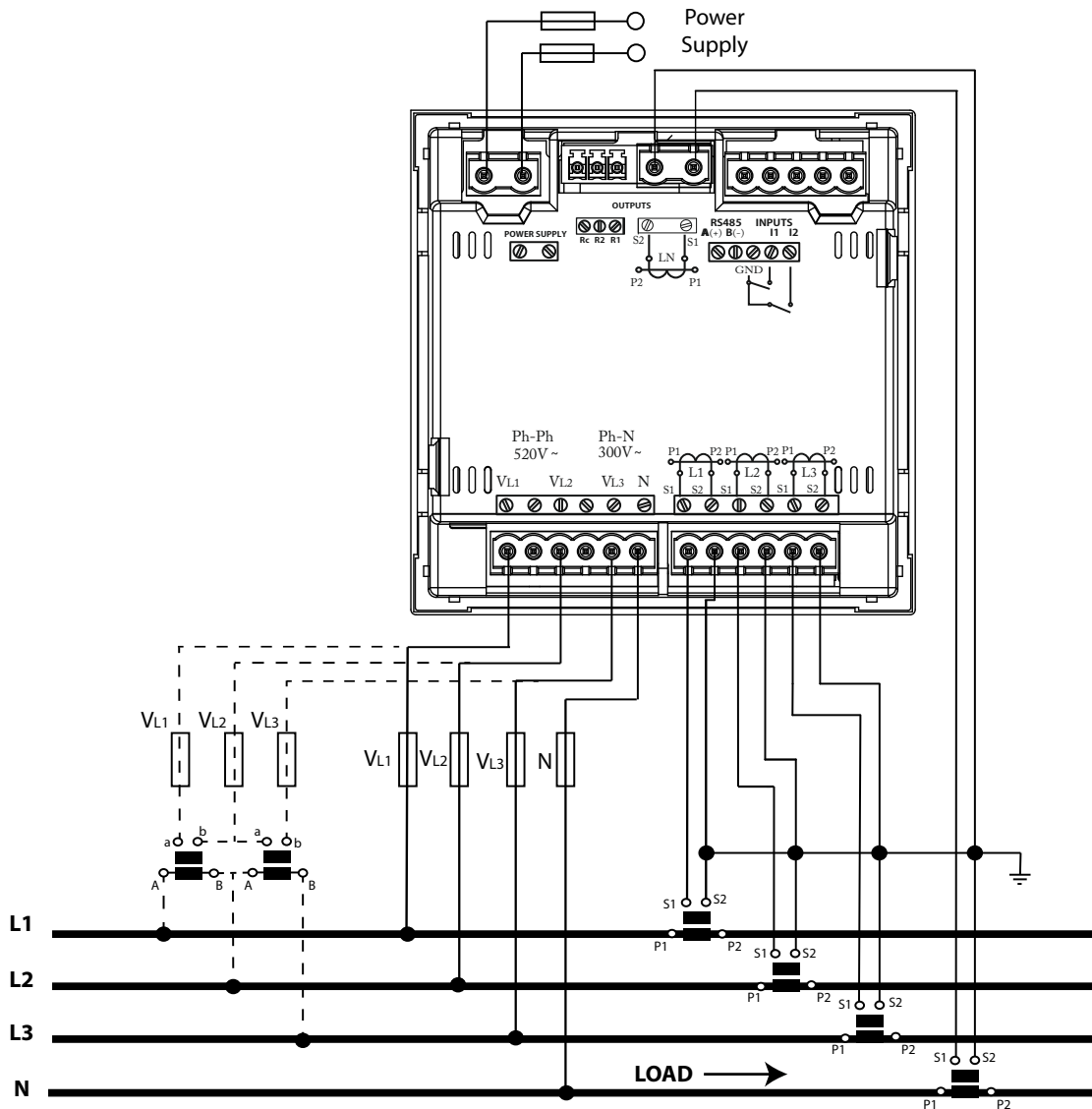

Figure 5: Three-Phase Measuring with a 4-wire connection, CVM-C10-ITF-IN model.



### 3.5.3.- MEASURING THREE-PHASE NETWORKS WITH A 4-WIRE CONNECTION CVM-C10-MC MODEL.

Measurement system: 4-3Ph

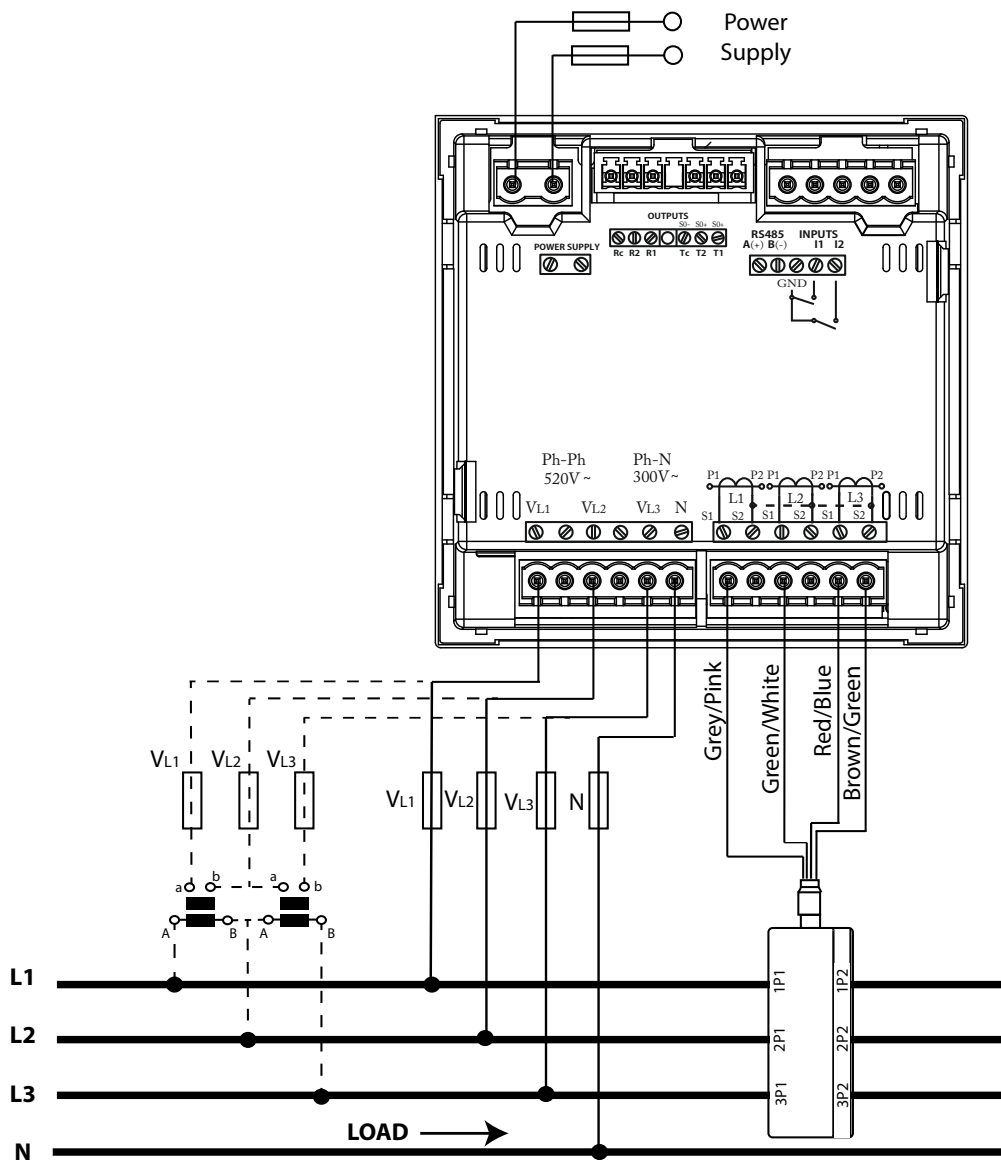

Figure 6: Three-Phase measuring with a 4-wire connection, CVM-C10-MC model.

**Note:** Do not connect MC current transformers to ground.

	<p>The MC transformer secondary value is set to 0.250 A (fixed value)</p>
--	---



### 3.5.5.- MEASURING THREE-PHASE NETWORKS WITH A 4-WIRE CONNECTION, CVM-C10-FLEX MODEL

Measurement system: 4-3Ph

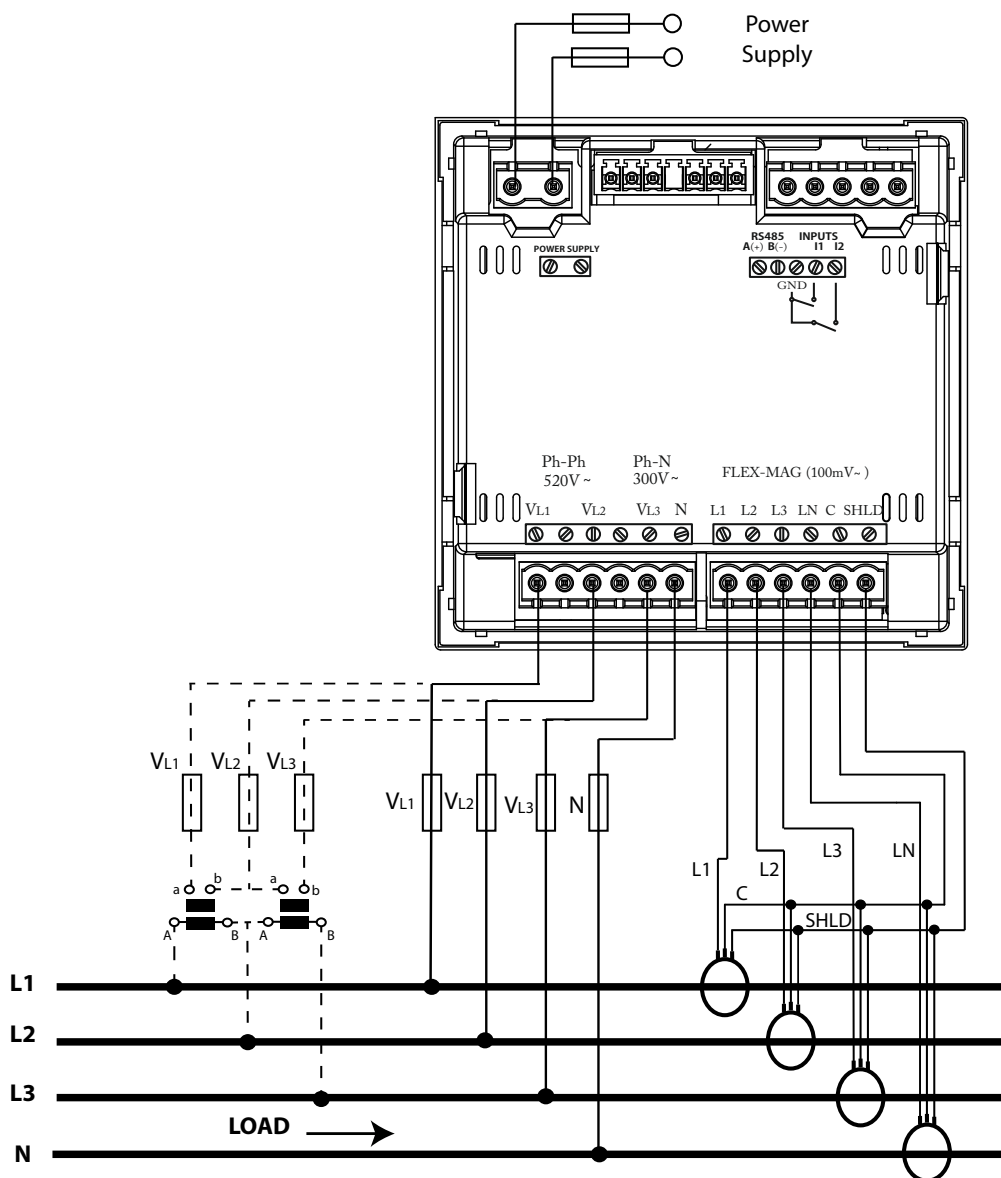

Figure 8: Three-Phase measuring with a 4-wire connection, CVM-C10-FLEX model.

	<p>It is mandatory connect the <b>SHLD</b> terminal of the probe.</p>
--	---

**3.5.6.- MEASURING THREE-PHASE NETWORKS WITH A 3-WIRE CONNECTION, CVM-C10-ITF AND CVM-C10-mV MODEL.**

Measurement system: **3-3Ph**

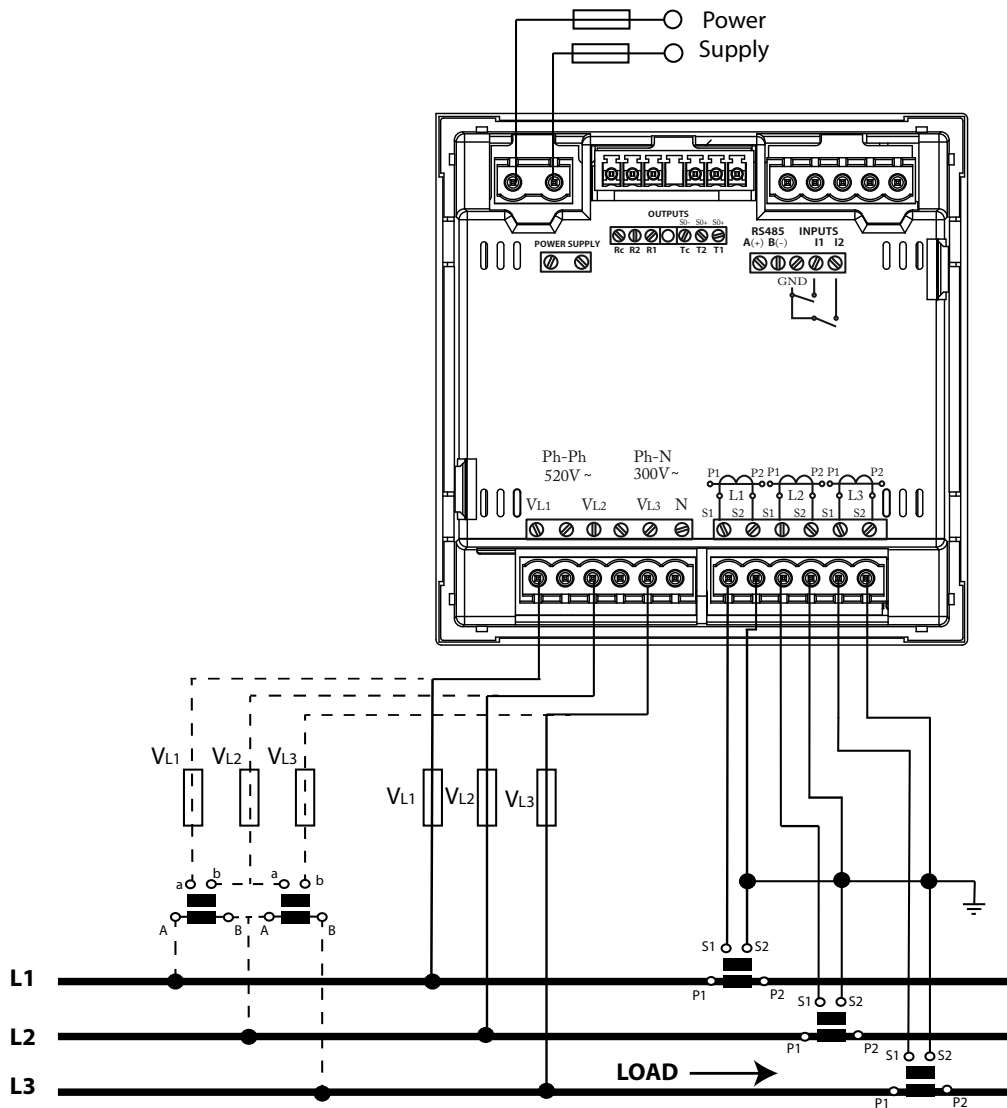

Figure 9: Three-Phase measuring with a 3-wire connection, CVM-C10-ITF and CVM-C10-mV model.

3.5.7.- MEASURING THREE-PHASE NETWORKS WITH A 3-WIRE CONNECTION, CVM-C10-MC MODEL.

Measurement system: **3-3Ph**

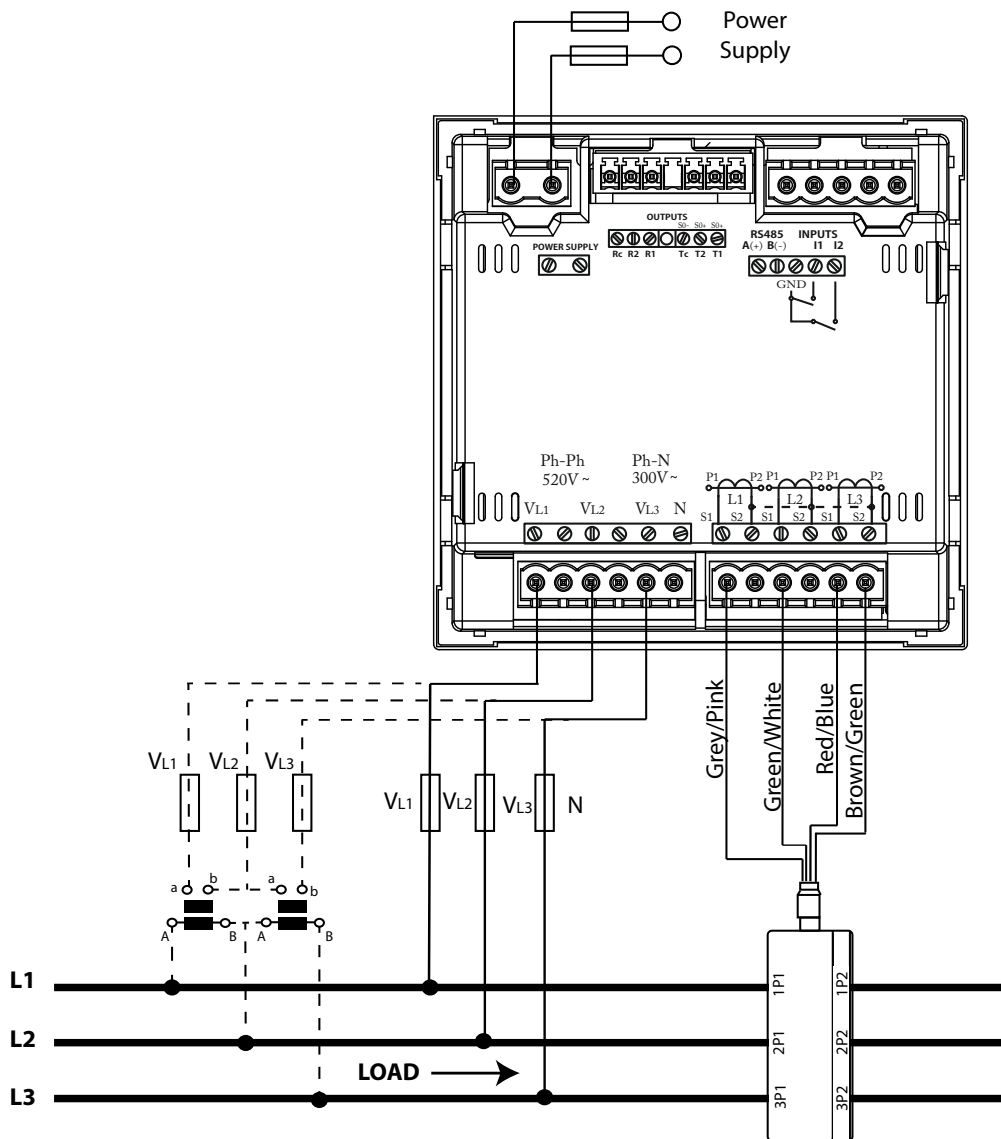

Figure 10: Three-Phase measuring with a 3-wire connection, CVM-C10-MC model.

**Note:** Do not connect MC current transformers to ground.

	<p>The MC transformer secondary value is set to 0.250 A (fixed value)</p>
--	---

3.5.8.- MEASURING THREE-PHASE NETWORKS WITH A 3-WIRE CONNECTION, CVM-C10-FLEX MODEL.

Measurement system: 3-3Ph

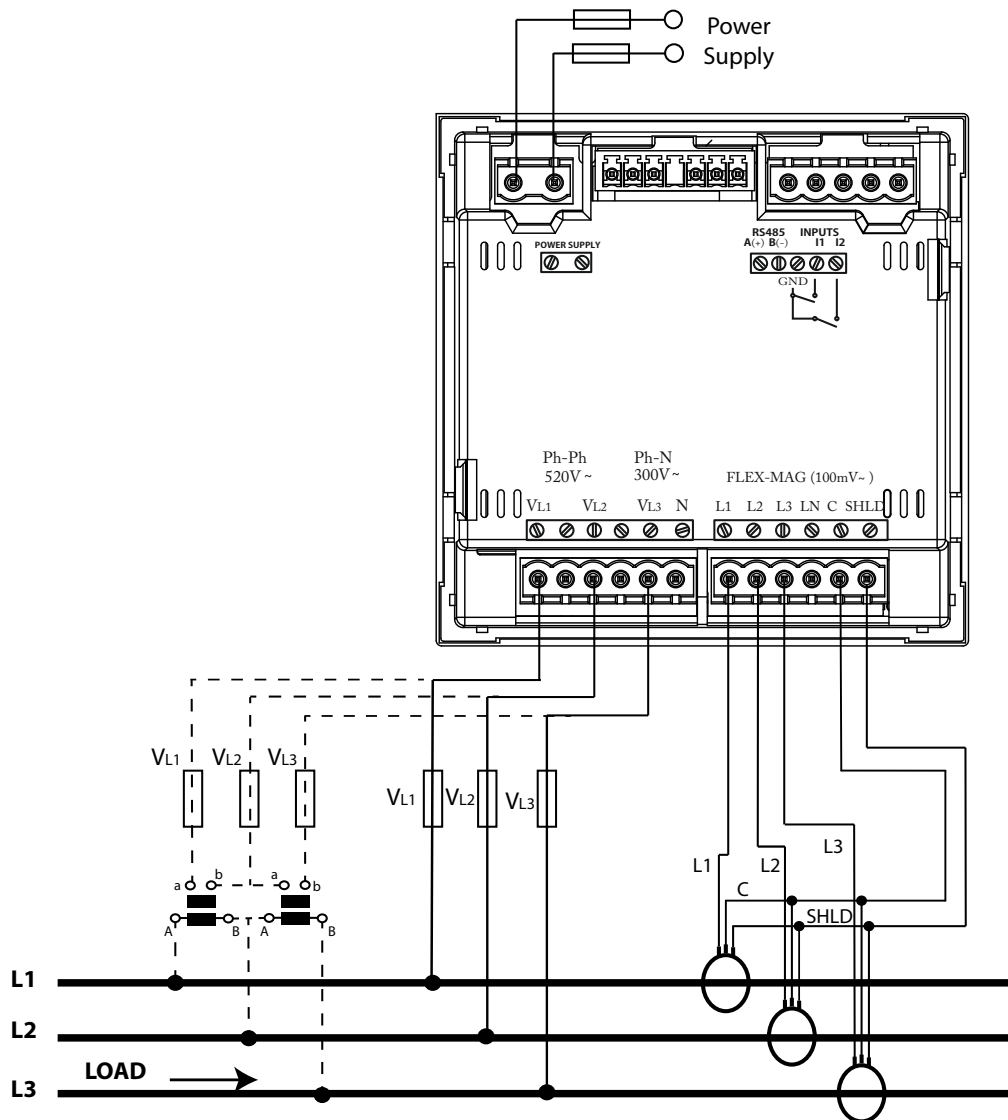

Figure 11: Three-Phase measuring with a 3-wire connection, CVM-C10-FLEX model.

	<p>It is mandatory connect the <b>SHLD</b> terminal of the probe.</p>
---	---

### 3.5.9.- MEASURING THREE-PHASE NETWORKS WITH A 3-WIRE CONNECTION AND TRANSFORMERS WITH AN ARON CONNECTION, CVM-C10-ITF AND CVM-C10-MC MODELS.

Measurement system: **3-Aron**

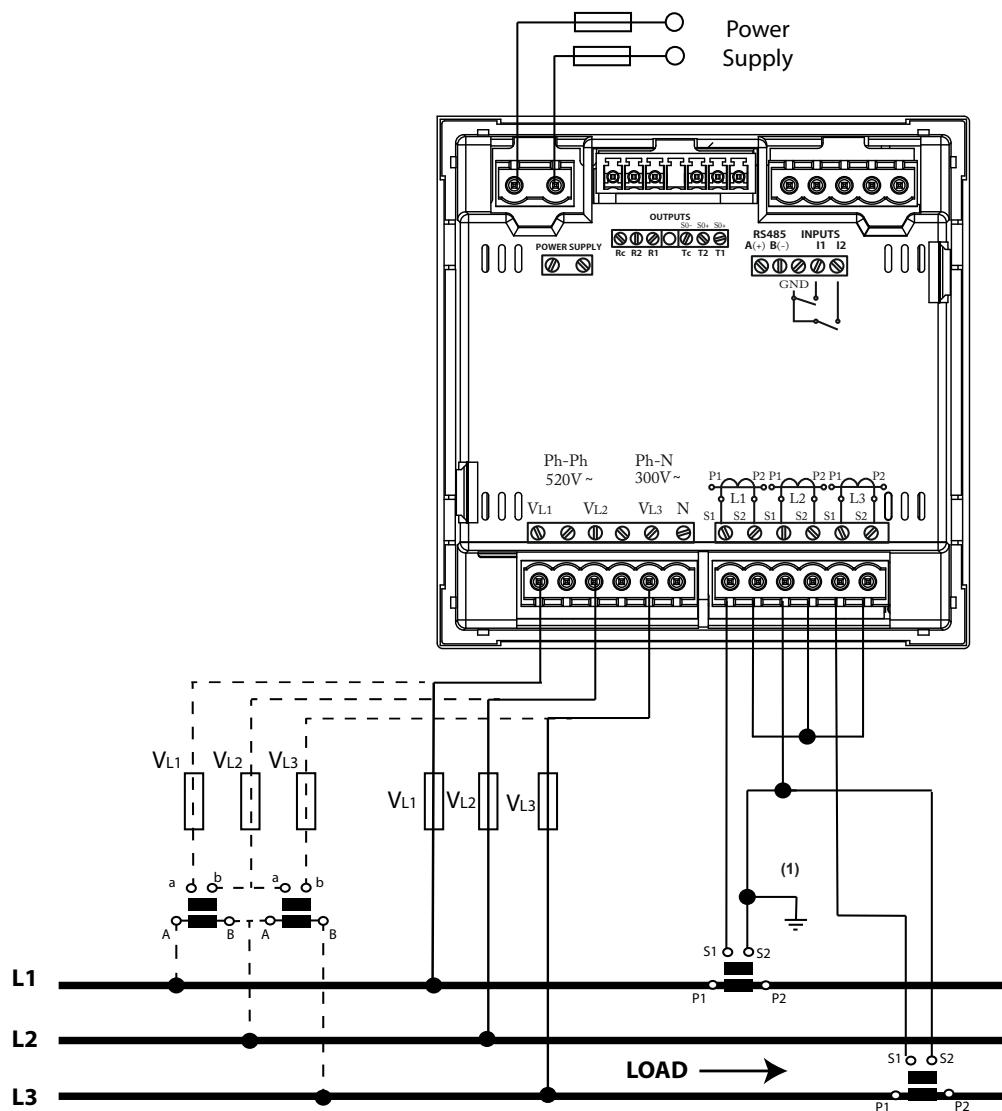

Figure 12: Three-Phase measuring with a 3-wire connection and transformers with an ARON connection, CVM-C10-ITF and CVM-C10-MC and models.

<sup>(1)</sup>**Note:** Do not connect MC current transformers to ground.



**CVM-C10-ITF** model:

The transformer secondary value must be 5A or 1A

**CVM-C10-MC** model:

The MC transformer secondary value is set to 0.250 A (fixed value)

3.5.10.- MEASURING TWO-PHASE NETWORKS WITH A 3-WIRE CONNECTION, CVM-C10-ITF, CVM-C10-MC AND CVM-C10-mV MODELS.

Measurement system: 3-2Ph

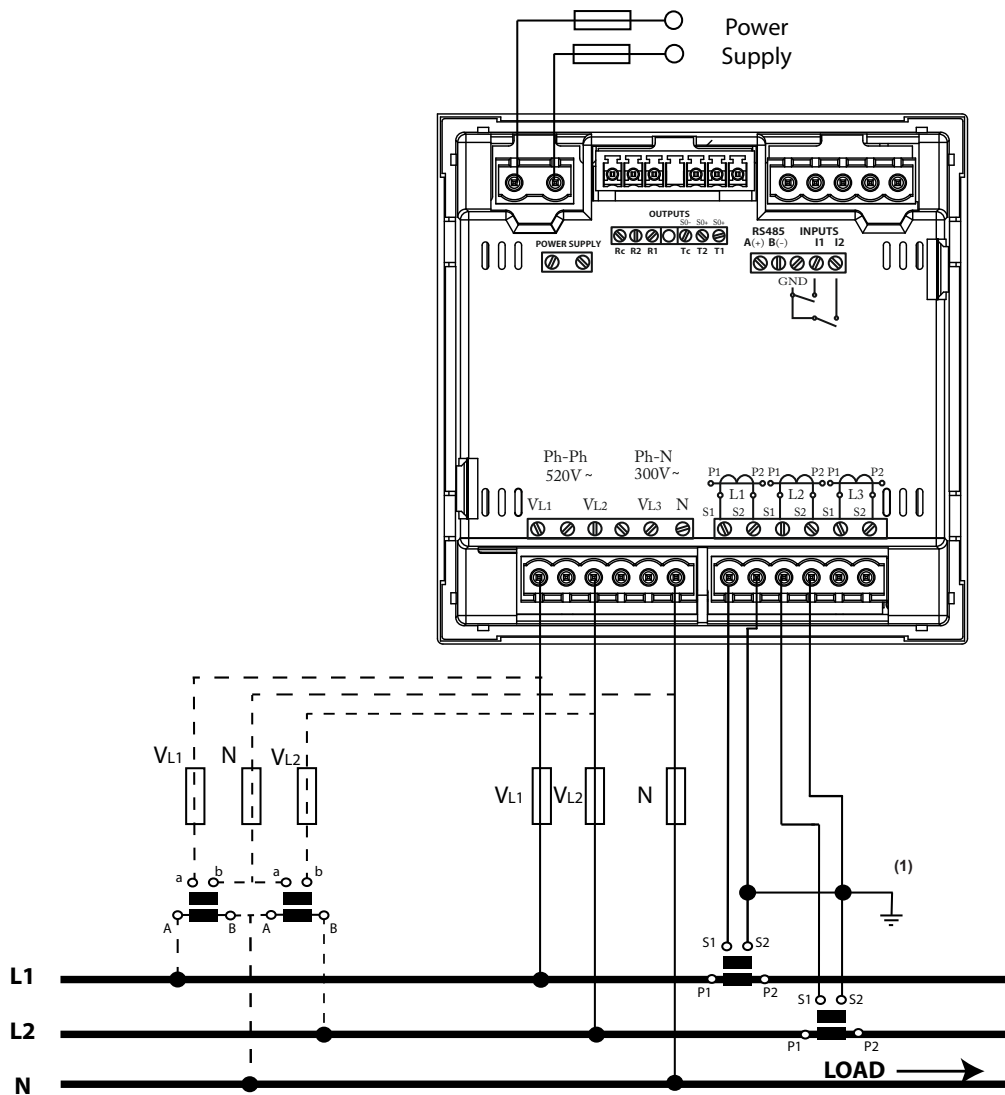



Figure 13: Measuring Two-Phase Networks with a 3-wire connection, CVM-C10-ITF, CVM-C10-MC and CVM-C10-mV models.

<sup>(1)</sup>**Note:** Do not connect MC current transformers to ground.

	<p><b>CVM-C10-ITF</b> model: The transformer secondary value must be 5A or 1A</p>
	<p><b>CVM-C10-MC</b> model: The MC transformer secondary value is set to 0.250 A (fixed value)</p>
	<p><b>CVM-C10-mV</b> model: The transformer secondary value must be 0.333 V</p>



### 3.5.11.- MEASURING TWO-PHASE NETWORKS WITH A 3-WIRE CONNECTION, CVM-C10-ITF-IN AND CVM-C10-MC-IN MODELS.

Measurement system: **3-2Ph**

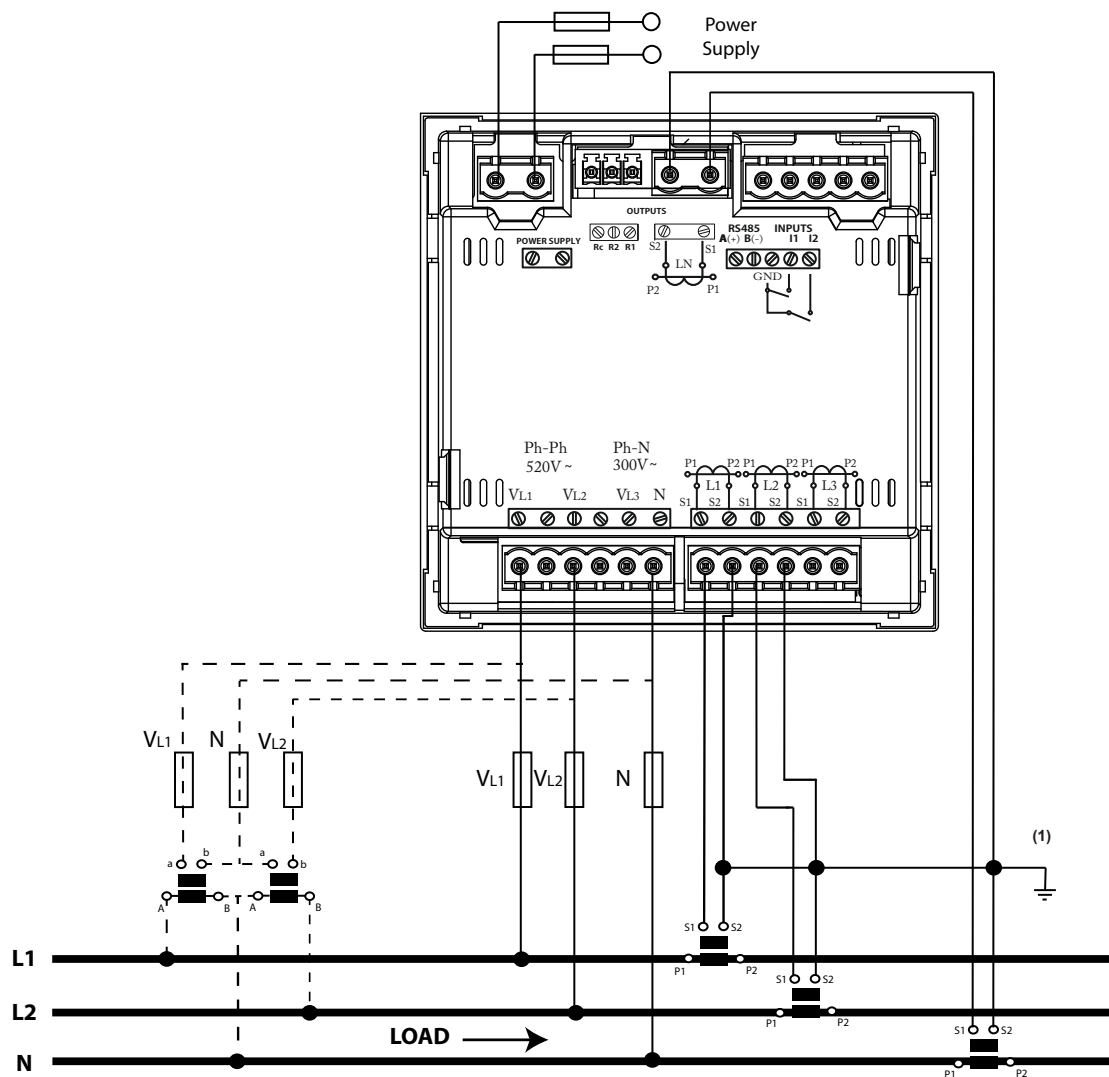

Figure 14: Measuring Two-Phase Networks with a 3-wire connection, CVM-C10-ITF-IN and CVM-C10-MC-IN models.

<sup>(1)</sup>**Note:** Do not connect MC current transformers to ground.



**CVM-C10-ITF-IN model:**

The transformer secondary value must be 5A or 1A

**CVM-C10-MC-IN model:**

The MC transformer secondary value is set to 0.250 A (fixed value)

3.5.12.- MEASURING TWO-PHASE NETWORKS WITH A 3-WIRE CONNECTION, CVM-C10-FLEX MODEL.

Measurement system: 3-2Ph

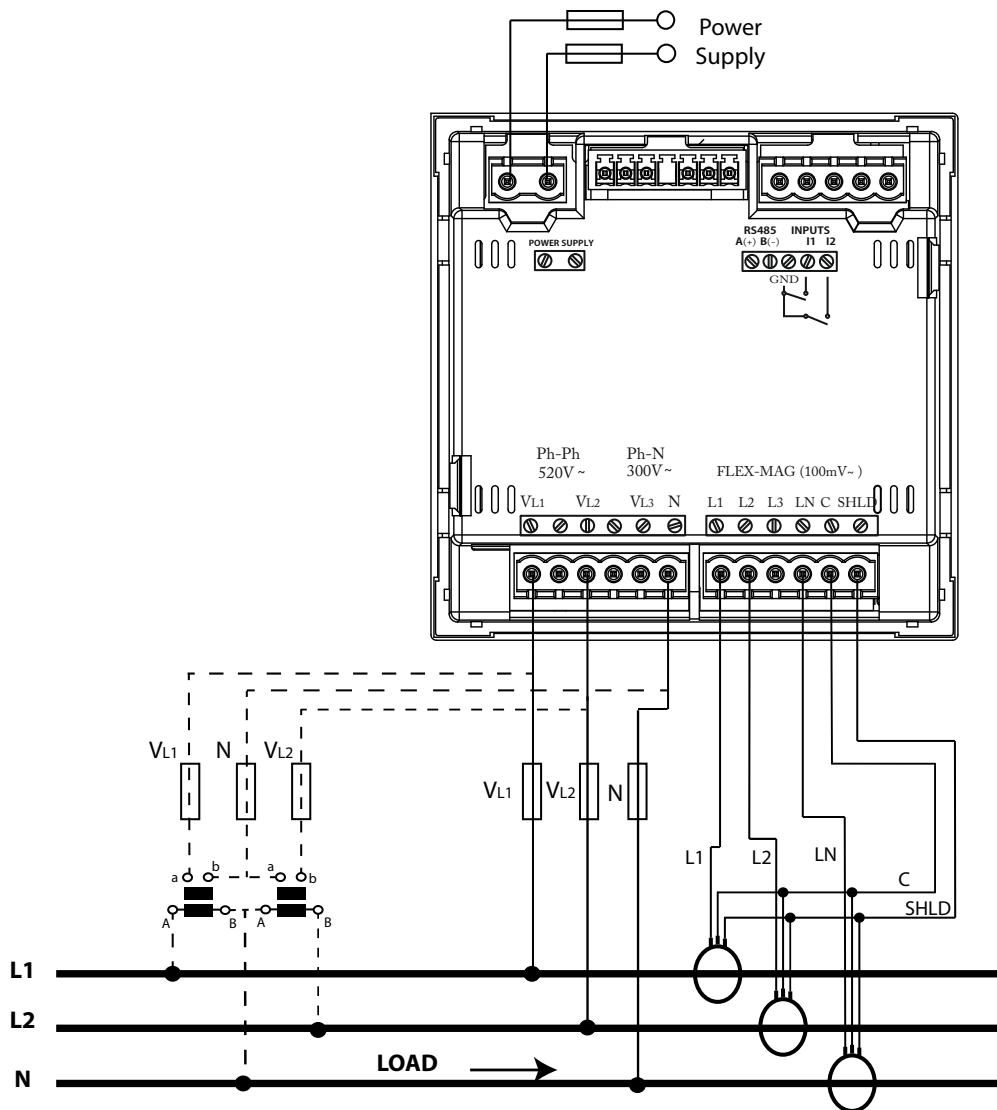



Figure 15: Measuring Two-Phase Networks with a 3-wire connection, CVM-C10-FLEX model.

	<p>It is mandatory connect the <b>SHLD</b> terminal of the probe.</p>
---	---

### 3.5.13.- MEASURING SINGLE-PHASE NETWORKS, PHASE TO PHASE, WITH A 2-WIRE CONNECTION, CVM-C10-ITF, CVM-C10-MC AND CVM-C10-mV MODELS.

Measurement system: **2-2Ph**

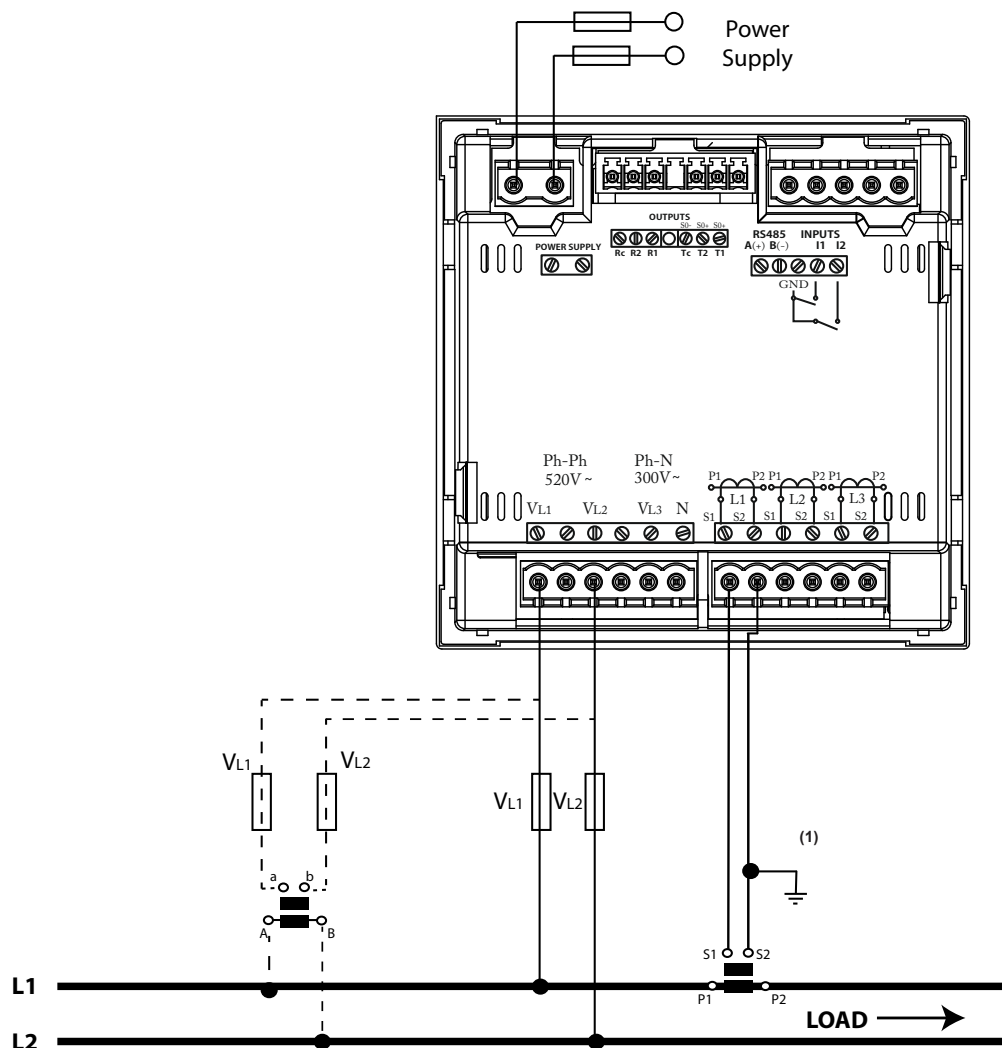

Figure 16: Measuring Single-Phase Networks, phase to phase, with a 2-wire connection, CVM-C10-ITF, CVM-C10-MC and CVM-C10-mV models.

<sup>(1)</sup>**Note:** Do not connect MC current transformers to ground.



**CVM-C10-ITF model:**

The transformer secondary value must be 5A or 1A

**CVM-C10-MC model:**

The MC transformer secondary value is set to 0.250 A (fixed value)

**CVM-C10-mV model:**

The transformer secondary value must be 0.333 V

3.5.14.- MEASURING SINGLE-PHASE NETWORKS, PHASE TO PHASE, WITH A 2-WIRE CONNECTION, CVM-C10-FLEX MODEL.

Measurement system: 2-2Ph

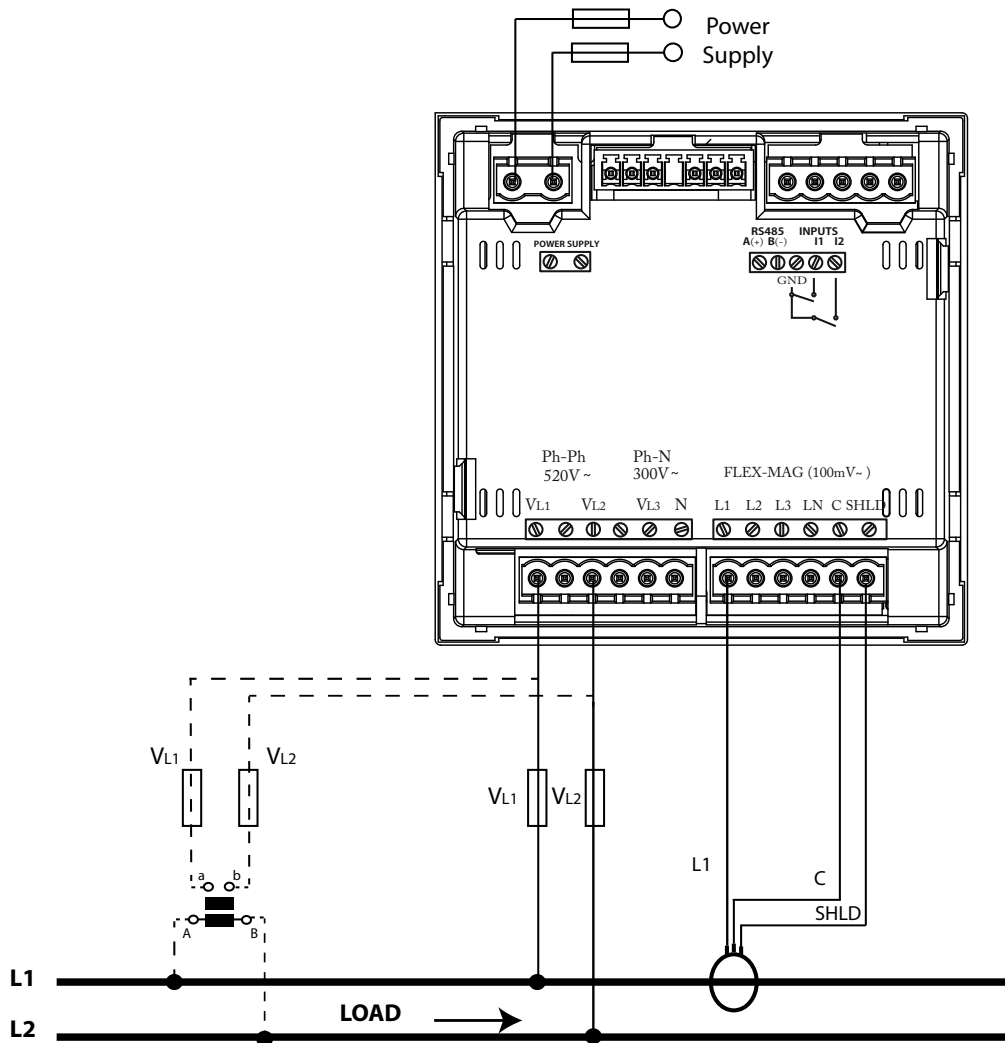

Figure 17: Measuring Single-Phase Networks, phase to phase, with a 2-wire connection, CVM-C10-FLEX model.

	<p>It is mandatory connect the <b>SHLD</b> terminal of the probe.</p>
--	---

### 3.5.15.- MEASURING SINGLE-PHASE NETWORKS, PHASE TO NEUTRAL, WITH A 2-WIRE CONNECTION, CVM-C10-ITF, CVM-C10-MC AND CVM-C10-mV MODELS.

Measurement system: **2 - 1Ph**

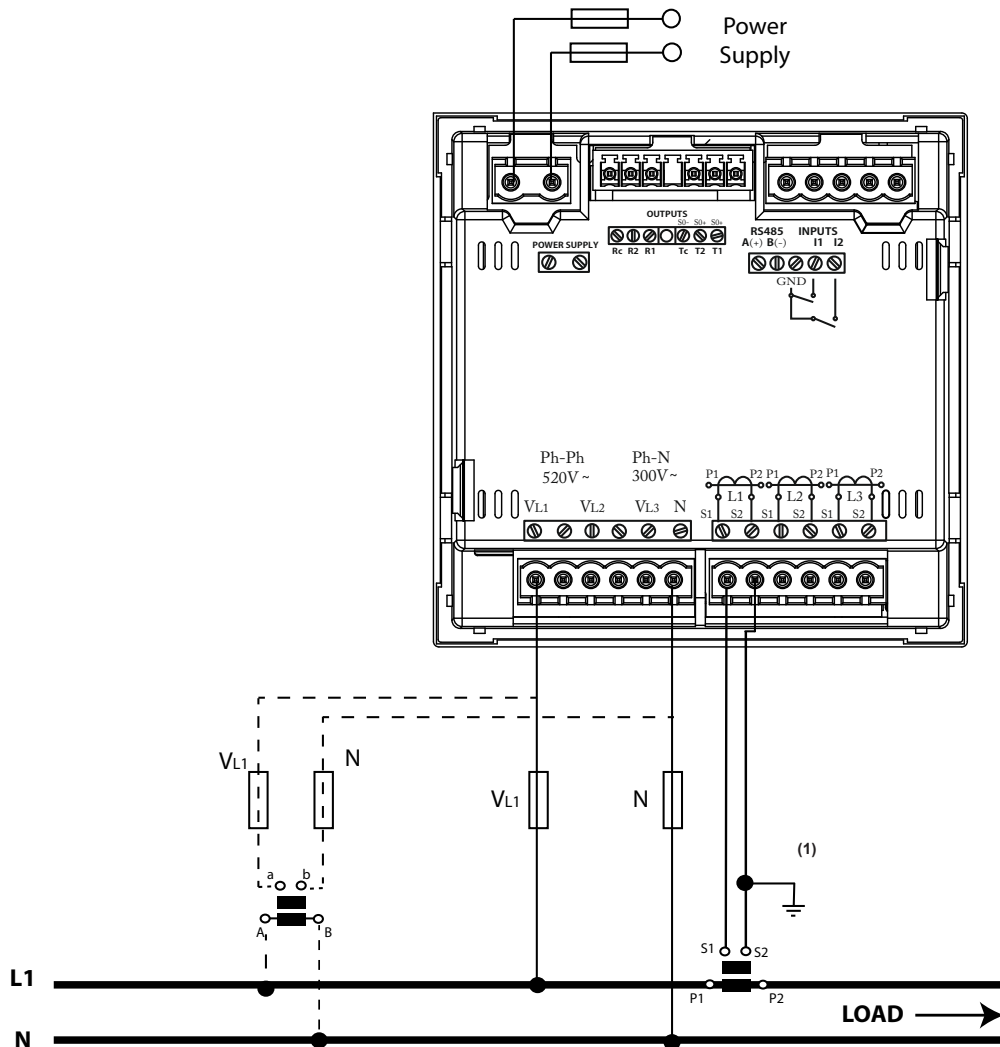

Figure 18: Measuring Single-Phase Networks, phase to neutral, with a 2-wire connection, CVM-C10-ITF, CVM-C10-MC and CVM-C10-mV models.

<sup>(1)</sup>**Note:** Do not connect MC current transformers to ground.



**CVM-C10-ITF** model:

The transformer secondary value must be 5A or 1A

**CVM-C10-MC** model:

The MC transformer secondary value is set to 0.250 A (fixed value)

**CVM-C10-mV** model:

The transformer secondary value must be 0.333 V

3.5.16.- MEASURING SINGLE-PHASE NETWORKS, PHASE TO NEUTRAL, WITH A 2-WIRE CONNECTION, CVM-C10-FLEX MODEL.

Measurement system: *2 - 1Ph*

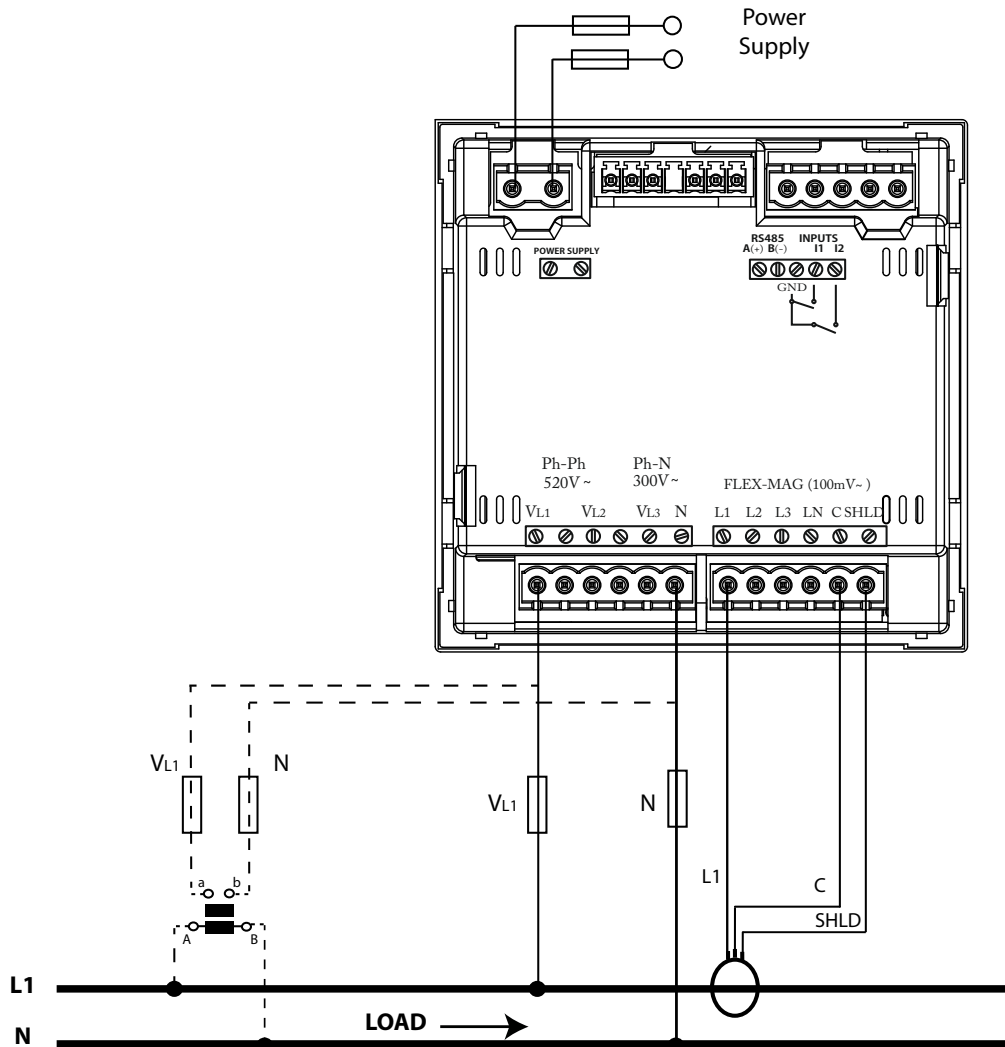

Figure 19: Measuring Single-Phase Networks, phase to neutral, with a 2-wire connection, CVM-C10-FLEX model.



It is mandatory connect the **SHLD** terminal of the probe.

## 4.- OPERATION

The **CVM-C10** is a four-quadrant power analyzer (consumption and generation). The device can operate according to three different measurement conventions:

- ✓ **CIRCUTOR** measurement convention.
- ✓ **IEC** measurement convention.
- ✓ **IEEE** measurement convention.

The measurement convention is configured in the setup menu, see “4.9.8. *Measurement convention*”.

- ✓ **CIRCUTOR**. measurement convention

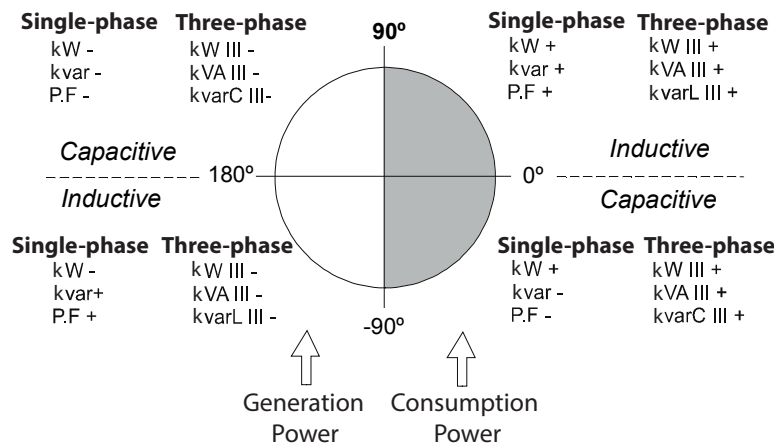
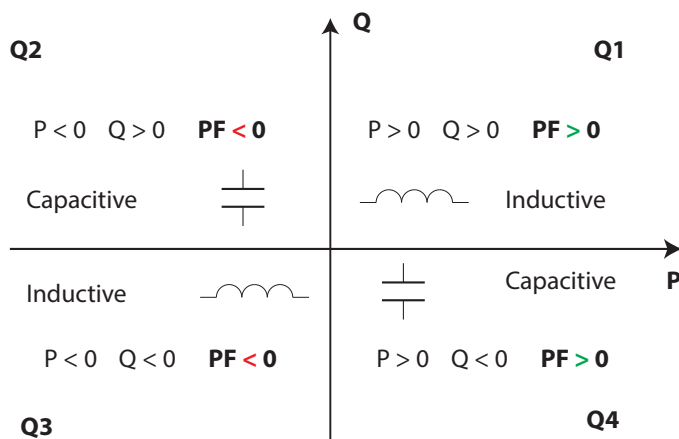

Figure 20: CIRCUTOR measurement convention.

- ✓ **IEC** measurement convention

Operation in the 4 quadrants (Q1, Q2, Q3, Q4)



cos φ values in the receiver operating mode (Q1, Q4)

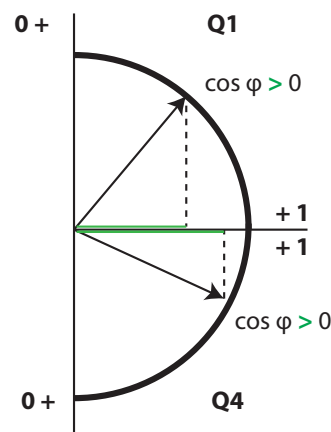
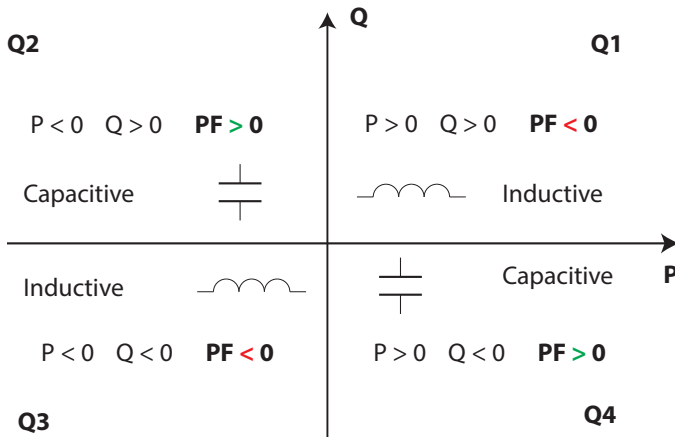

Figure 21: Convenio de medida IEC.

✓ **IEEE** measurement convention

**Operation in the 4 quadrants (Q1, Q2, Q3, Q4)**



**cos φ values in the receiver operating mode (Q1,Q4)**

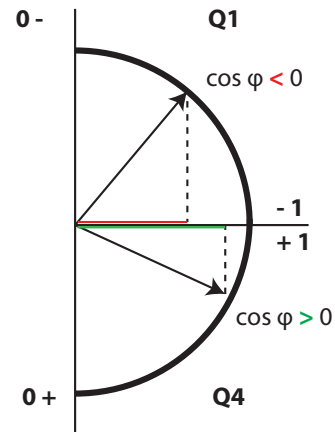

Figure 22: Convenio de medida IEEE.

#### 4.1.- MEASURING PARAMETERS

The device displays the electrical parameters shown in **Table 7**.

Table 7: Measuring parameters of the CVM-C10.

Parameter	Units	Phases L1-L2-L3	Total III	N
Phase-neutral voltage	Vph-N	✓		
Phase-phase voltage	Vph-ph	✓	✓	
Current	A	✓	✓	✓
Frequency	Hz	✓	✓	
Active power	M/kW	✓	✓	
Apparent power	M/kVA	✓	✓	
Total Reactive Power	M/kvar	✓	✓	
Total Reactive Power - Consumption	M/kvar	✓	✓	
Total Reactive Power - Generation	M/kvar	✓	✓	
Total Inductive Reactive Power	M/kvarL	✓	✓	
Inductive Reactive Power - Consumption	M/kvarL	✓	✓	
Inductive Reactive Power - Generation	M/kvarL	✓	✓	
Total Capacitive Reactive Power	M/kvarC	✓	✓	
Capacitive Reactive Power - Consumption	M/kvarC	✓	✓	
Capacitive Reactive Power - Generation	M/kvarC	✓	✓	
Power factor	PF	✓	✓	
Cos φ	φ	✓	✓	
THD % Voltage	% THD V	✓		
THD % Current	% THD A	✓		
Harmonic Breakdown - Voltage (up to the 31st order harmonic)	harm V	✓		



Table 7 (Continuation) : Measuring parameters of the CVM-C10.

Parameter	Units	Phases L1-L2-L3	Total III	N
Harmonic Breakdown - Current (up to the 31st order harmonic)	harm V	✓		
Total Active Energy	M/kWh		✓	
Total Inductive Reactive Energy	M/kvarLh		✓	
Total Capacitive Reactive Energy	M/kvarCh		✓	
Total Apparent Energy	M/kVAh		✓	
Active Energy Tariff 1	M/kWh		✓	
Inductive Reactive Energy Tariff 1	M/kvarLh		✓	
Capacitive Reactive Energy Tariff 1	M/kvarCh		✓	
Apparent Energy Tariff 1	M/kVAh		✓	
Active Energy Tariff 2	M/kWh		✓	
Inductive Reactive Energy Tariff 2	M/kvarLh		✓	
Capacitive Reactive Energy Tariff 2	M/kvarCh		✓	
Apparent Energy Tariff 2	M/kVAh		✓	
Active Energy Tariff 3	M/kWh		✓	
Inductive Reactive Energy Tariff 3	M/kvarLh		✓	
Capacitive Reactive Energy Tariff 3	M/kvarCh		✓	
Apparent Energy Tariff 3	M/kVAh		✓	
Maximum Current Demand	A	✓	✓	
Maximum Demand of Active power	M/kW		✓	
Maximum Demand of Apparent Power	M/kVA		✓	
Maximum Demand of inductive Reactive Power	M/kvarLh		✓	
Maximum Demand of capacitive Reactive Power	M/kvarCh		✓	
Parameter	Units	Tariff: T1-T2-T3		Total
No. of hours	hours	✓		✓
Cost	COST	✓		✓
CO <sub>2</sub> Emissions	kgCO <sub>2</sub>	✓		✓

## 4.2.- KEYBOARD FUNCTIONS

The **CVM-C10** has 3 keys that allow you to browse between the various screens and program the device.

Key functions on measuring screens (Table 8):

Table 8: Key functions on measuring screens.









Key	Short keystroke	Long keystroke (2 s)
	Previous screen	Display of minimum value
	Next screen	Display of maximum value

Table 8 (Continuation) : Key functions on measuring screens.

Key	Short keystroke	Long keystroke (2 s)
	Browsing the different profiles (analyzer, user, e3)	Accessing the programming menu
		Display of the Maximum Demand
		Active alarm information
		Unlocks the active alarm



Key functions on harmonics screens (Table 9):

Table 9: Key functions on harmonics screens.

Key	Short keystroke	Long keystroke (2 s)
	Output of the harmonics screens	
	Next screen	
	Browsing the different types of harmonics	Accessing the programming menu



Key functions on the programming menu, query mode (Table 10):

Table 10: Key functions on the programming menu, query mode.

Key	Short keystroke	Long keystroke (2 s)
	Previous screen	Programming output
	Next screen	Programming output
		Opening the programming menu in the edit mode

Key functions on the programming menu, edit mode (Table 11):

Table 11: Key functions on the programming menu, edit mode.

Key	Keystroke
	Line jump.
	Increases the digits (0-9) or rotates between the different options.
	Moves an editable digit (flashing)

### 4.3.- DISPLAY

The device has a backlit LCD display showing all the parameters listed in Table 3. The display is divided into four areas (Figure 23):

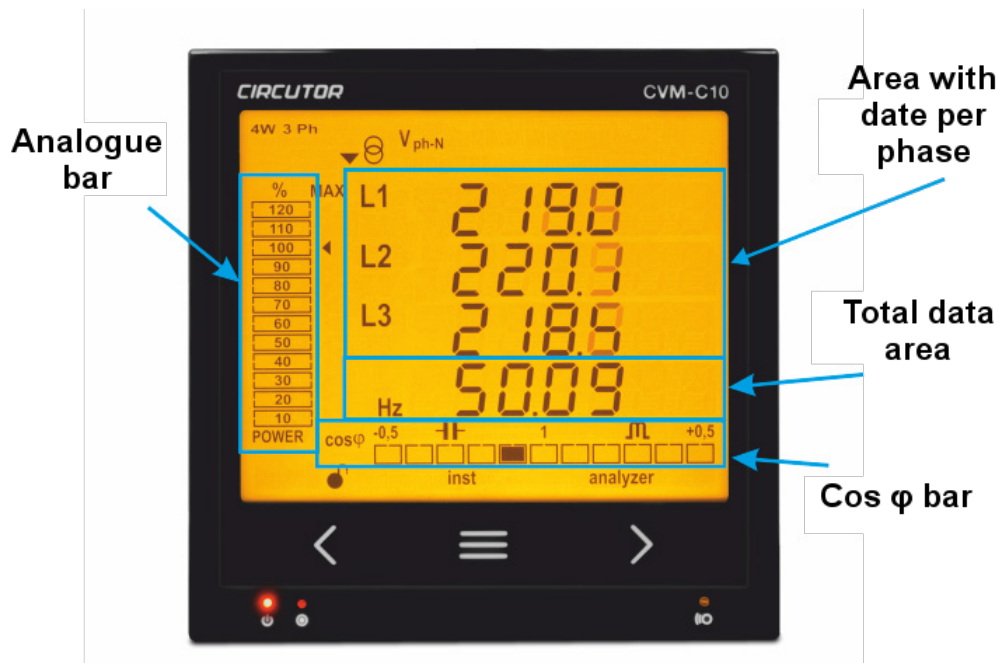

Figure 23: CVM-C10 Display areas

✓ The area with **data per phase** displays the instantaneous, maximum and minimum values of each phase being measured or calculated by the device.

✓The **total data** area displays the totals of the values being measured or calculated by the device.

✓**Analogue bar**, displays the % of the current power of the installation.

✓**Cos φ - PF Bar**, displays the value of the system's Cos φ or power factor in real time.

#### 4.3.1. cos φ - PF (POWER FACTOR) BAR



Figure 24: Cos φ - PF Bar

This bar displays the value of the installation's cos φ or power factor in real time. The parameter that will be displayed is selected on the programming menu. (“4.9.14. **Selecting the Cos φ - PF bar on the display**”)

**Note :** This bar will not be displayed in the IEC and IEEE measurement conventions.

### 4.3.2. ANALOGUE BAR

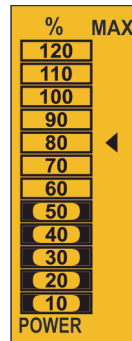

Figure 25: Analogue Bar

The analogue bar displays two parameters:

✓ **Current power of the installation in %**

This parameter is displayed in 12 divisions, each one represents 10%, into which the analogue bar is divided.

The device calculates the current power of the installation using the formula:

$$P = V \cdot I \cdot \cos(\varphi)$$

Where the voltage and the  $\cos(\varphi)$  are the installation's current values.

The current is referenced in its full scale. (100% is the full scale of the device and a value above 100% indicates that it is out of range).

✓ **The maximum system demand reached**, i.e., the maximum power value reached since the device was started, expressed as a percentage.

This value is displayed with the icon ◀.

The value and the maximum and minimum values are reset. (**"4.9.15. Deleting maximum and minimum values"**)

**Example:** Figure 25 shows that the installation performance is 50% and that the maximum demand of the system is 80%.

### 4.3.3. OTHER SYMBOLS ON THE DISPLAY

The following are also shown on the display:

✓ **Type of installation**

The type of installation to which the device is connected can be selected on the programming menu, (**"4.9.9. Type of installation"**). The selected type is shown on the top left of the display.

✓ **State of digital inputs**

If the digital inputs have been activated, the top left of the display will show the icons I1 I2 that indicate that the digital input is active.

#### 4.4.- LED INDICATORS

The **CVM-C10** device has 3 LEDs:

- **CPU**, indicates that the device is on, flashing each second.
- **ALARM**, indicates that an alarm has been activated if it is on
- **KEY**, LED that is lit when any key is pressed.

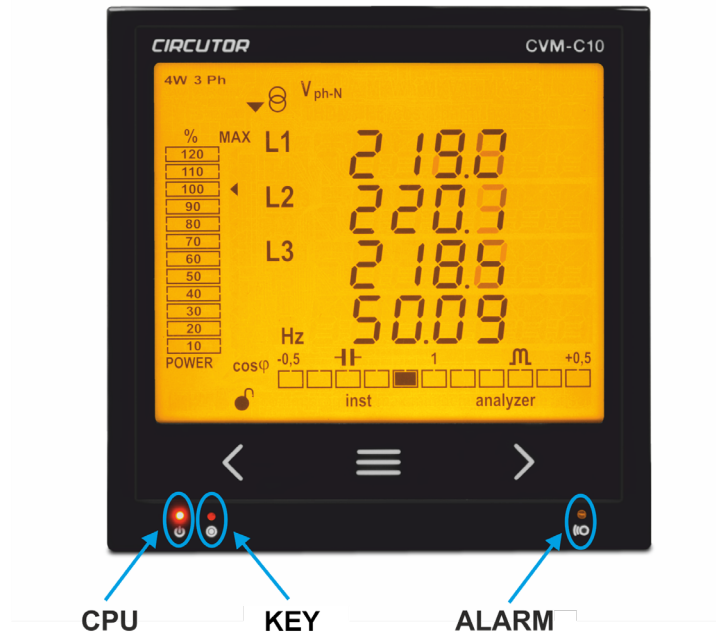

Figure 26: LED Indicators of the CVM-C10.

#### 4.5.- OPERATION PROFILES

The **CVM-C10** has 3 operation profiles. The display screens will be opened for the corresponding profile:

- ✓ Analyzer profile, **analyzer**,
- ✓ Electrical energy efficiency profile, **e<sup>3</sup>**,
- ✓ User profile, **user**,

##### 4.5.1. ANALYZER PROFILE

This profile is identified with the **analyzer** symbol on the bottom of the screen (Figure 27)

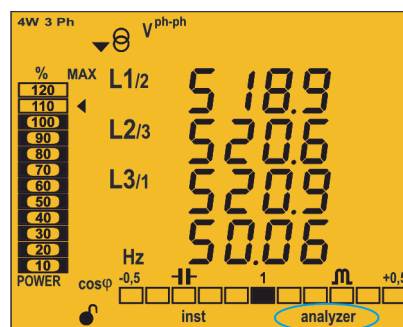

Figure 27: CVM-C10 screen with the analyzer profile.

The device displays 11 different screens for the **analyzer** profile (Table 12) and the voltage and current harmonics, up to the 31st order harmonic, for each one of the lines, L1, L2 and L3. (“4.6.- HARMONICS”)

Use keys **<** and **>** to browse the different screens.

The **inst** symbol on the bottom of the screen indicates that the values being displayed are of the instantaneous type.

**Table 12: Analyzer profile screens.**

Screen	Parameters (units)
<p>4W 3 Ph V<sup>ph-ph</sup> % MAX 120 110 100 90 80 70 60 50 40 30 20 10 POWER cosφ -0.5 1 +0.5 inst analyzer</p>	<p>phase-phase Voltage L1-L2 (V<sup>ph-ph</sup>) phase-phase Voltage L2-L3 (V<sup>ph-ph</sup>) phase-phase Voltage L3-L1 (V<sup>ph-ph</sup>) Frequency (Hz)</p>
<p>4W 3 Ph V<sup>ph-N</sup> % MAX 120 110 100 90 80 70 60 50 40 30 20 10 POWER cosφ -0.5 1 +0.5 inst analyzer</p>	<p>phase-neutral Voltage L1 (V<sup>ph-N</sup>) phase-neutral Voltage L2 (V<sup>ph-N</sup>) phase-neutral Voltage L3 (V<sup>ph-N</sup>) Frequency (Hz)</p>
<p>4W 3 Ph A % MAX 120 110 100 90 80 70 60 50 40 30 20 10 POWER cosφ -0.5 1 +0.5 inst analyzer</p>	<p>Current L1 (A) Current L2 (A) Current L3 (A) Neutral Current (A)<sup>(2)</sup></p> <p><sup>(2)</sup> Not available for the 3-3Ph and 3-AR-0N installation types.</p>
<p>4W 3 Ph KW % MAX 120 110 100 90 80 70 60 50 40 30 20 10 POWER cosφ -0.5 1 +0.5 inst analyzer</p>	<p>Active Power L1 (M/K W) Active Power L2 (M/K W) Active Power L3 (M/K W) Active Power III (M/K W)</p> <p>The generation values are not measured when the 2 quadrant option is selected.</p>

Table 12 (Continuation) : Analyzer profile screens.

Screen	Parameters (units)
	<p>Apparent Power L1 (M/KVA)                      Apparent Power L2 (M/KVA)                      Apparent Power L3 (M/KVA)                      Apparent Power III (M/KVA)</p> <p><i>The generation values are not measured when the 2 quadrant option is selected.</i></p>
	<p>Inductive Reactive Power L1 (M/Kvar<sup>L</sup>)                      Inductive Reactive Power L2 (M/Kvar<sup>L</sup>)                      Inductive Reactive Power L3 (M/Kvar<sup>L</sup>)                      Inductive Reactive Power III (M/Kvar<sup>L</sup>)</p>
	<p>Capacitive Reactive Power L1 (M/Kvar<sub>C</sub>)                      Capacitive Reactive Power L2 (M/Kvar<sub>C</sub>)                      Capacitive Reactive Power L3 (M/Kvar<sub>C</sub>)                      Capacitive Reactive Power III (M/Kvar<sub>C</sub>)</p>
	<p>THD % Voltage L1 (V THD %)                      THD % Voltage L2 (V THD %)                      THD % Voltage L3 (V THD %)</p>
	<p>THD % Current L1 (A THD %)                      THD % Current L2 (A THD %)                      THD % Current L3 (A THD %)</p>

Table 12 (Continuation) : Analyzer profile screens.

Screen	Parameters (units)
	Power factor L1 (PF) Power factor L2 (PF) Power factor L3 (PF) Power factor III (PF)
	Cos φ L1 (cos φ) Cos φ L2 (cos φ) Cos φ L3 (cos φ) Cos φ III (cos φ)

Also displayed on these screens are:

✓ **Maximum values**

To see the maximum values of the screen being displayed, press the key for 2 seconds. These are displayed for 30 seconds. The **max** symbol is shown on the display (**Figure 28**)  
 The maximum and minimum values are reset on the programming menu. (“4.9.15. **Deleting maximum and minimum values**”)

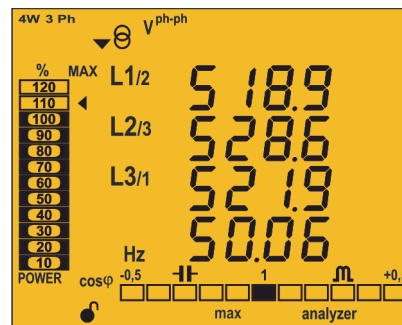

Figure 28: Analyzer profile screen displaying the maximum values.

✓ **Minimum values**

To see the minimum values of the screen being displayed, press the key for 2 seconds. These are displayed for 30 seconds. The **min** symbol will be displayed (**Figure 29**)  
 The maximum and minimum values are reset on the programming menu. (“4.9.15. **Deleting maximum and minimum values**”)



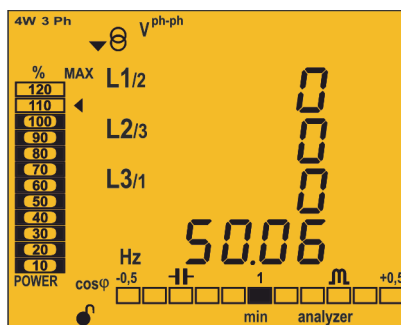



Figure 29: Analyzer profile screen displaying the minimum values.

### ✓ Maximum Demand

The device calculates the maximum demand of the following:

- Current
- Three-Phase Active Power.
- Three-Phase Apparent Power.
- Three-Phase Inductive Reactive Power
- Three-Phase Capacitive Reactive Power

This value can be displayed on the display screen of the parameter by pressing the  and  keys at the same time. The **dem** symbol appears on the display (Figure 30)

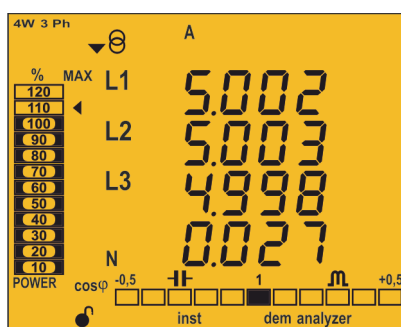

Figure 30: Analyzer profile screen displaying the maximum demand values.

Press keys  or  to stop displaying the maximum demand values.

The maximum demand values are reset on the programming menu: **“4.9.11. Deleting maximum demand”**

#### 4.5.1.1. Detection of incorrect direction of rotation (Version 4.05 or higher)

The device has a system for detecting the incorrect direction of rotation of the voltages. In other words, if each of the voltages has been correctly connected to the appropriate terminal, L1 to terminal **VL1**, L2 to terminal **VL2** and L3 to terminal **VL3**.

If there is an error in the direction of rotation, the icons **L1**, **L2** and **L3** flash on the display.

The device has a RS-485 communications parameter, which indicates whether an incorrect direction of rotation has been detected (“4.10.3.7. **Detection of incorrect direction of rotation.**”)

**Note:** The detection of the direction of rotation is only enabled for measurement systems: Three-phase network measurement (4-3Ph, 3-3Ph y 3-AR-0n) and two-phase network measurement with 3-wire connection (3-2Ph).

### 4.5.2. e<sup>3</sup> PROFILE

This profile is identified with the e<sup>3</sup> symbol on the bottom of the screen (Figure 31).

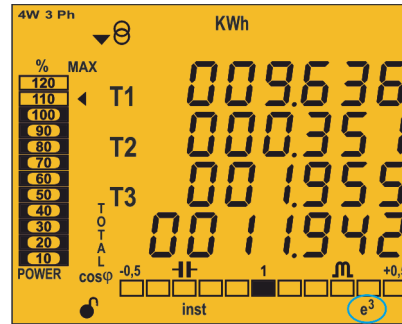

Figure 31: CVM-C10 screen with the e<sup>3</sup> profile.

The installation's consumed and generated energy are displayed on the e<sup>3</sup> profile of the device.

The installation status is also displayed:

- ▼ Installation is consuming energy.
- ▲ Installation is generating energy.

A long keystroke (3 sec) of key will display the generation values.

The generation values are identified with the negative sign on the screen, which appears in front of each parameter.

A long keystroke (3 sec) of key will display the consumption values.

Use keys and to browse the different screens (short keystroke).

Table 13: Screens of the e<sup>3</sup> profile.

Screen	Parameters (units)
	Active Energy Tariff 1 , T1 (M/KWh) Active Energy Tariff 2 , T2 (M/KWh) Active Energy Tariff 3 , T3 (M/KWh) Total Active Energy (M/KWh)  <i>Consumption and generation values</i>  <i>Only available for the 4 quadrant option.</i>
	Apparent Energy Tariff 1 , T1 (M/KVAh) Apparent Energy Tariff 2 , T2 (M/KVAh) Apparent Energy Tariff 3 , T3 (M/KVAh) Total Apparent Energy (M/KVAh)  <i>Consumption and generation values</i>  <i>Only available for the 4 quadrant option.</i>

Table 13 (Continuation) : Screens of the e<sup>3</sup> profile.

Screen	Parameters (units)
<p>4W 3 Ph Kvar<sup>L</sup>h % MAX 120 110 100 90 80 70 60 50 40 30 20 10 T O T A L POWER cosφ -0,5 -1 1 +0,5 inst e<sup>3</sup></p>	<p>Inductive Reactive Energy Tariff 1, T1 (M/Kvar<sup>L</sup>h) Inductive Reactive Energy Tariff 2, T2 (M/Kvar<sup>L</sup>h) Inductive Reactive Energy Tariff 3, T3 (M/Kvar<sup>L</sup>h) Total Inductive Reactive Energy (M/Kvar<sup>L</sup>h)</p> <p><i>Consumption and generation values</i></p> <p><i>Only available for the 4 quadrant option.</i></p>
<p>4W 3 Ph Kvar<sup>C</sup>h % MAX 120 110 100 90 80 70 60 50 40 30 20 10 T O T A L POWER cosφ -0,5 -1 1 +0,5 inst e<sup>3</sup></p>	<p>Capacitive Reactive Energy Tariff 1, T1 (M/Kvar<sup>C</sup>h) Capacitive Reactive Energy Tariff 2, T2 (M/Kvar<sup>C</sup>h) Capacitive Reactive Energy Tariff 3, T3 (M/Kvar<sup>C</sup>h) Total Capacitive Reactive Energy (M/Kvar<sup>C</sup>h)</p> <p><i>Consumption and generation values</i></p> <p><i>Only available for the 4 quadrant option.</i></p>
<p>4W 3 Ph cost % MAX 120 110 100 90 80 70 60 50 40 30 20 10 T O T A L POWER cosφ -0,5 -1 1 +0,5 inst e<sup>3</sup></p>	<p>Cost Tariff 1, T1 (cost) Cost Tariff 2, T2 (cost) Cost Tariff 3, T3 (cost) Total Cost (cost)</p> <p><i>Consumption and generation values</i></p>
<p>4W 3 Ph kgCO<sub>2</sub> % MAX 120 110 100 90 80 70 60 50 40 30 20 10 T O T A L POWER cosφ -0,5 -1 1 +0,5 inst e<sup>3</sup></p>	<p>CO<sub>2</sub> Emissions Tariff 1, T1 (kgCO<sub>2</sub>) CO<sub>2</sub> Emissions Tariff 2, T2 (kgCO<sub>2</sub>) CO<sub>2</sub> Emissions Tariff 3, T3 (kgCO<sub>2</sub>) Total CO<sub>2</sub> Emissions (kgCO<sub>2</sub>)</p> <p><i>Consumption and generation values</i></p>
<p>4W 3 Ph hours % MAX 120 110 100 90 80 70 60 50 40 30 20 10 T O T A L POWER cosφ -0,5 -1 1 +0,5 inst e<sup>3</sup></p>	<p>No. of hours Tariff 1, T1(hours) No. of hours Tariff 2, T2(hours) No. of hours Tariff 3, T3(hours) Total No. of hours (hours)</p>

Symbols **T1**, **T2** and **T3** on the display indicate the three tariffs available on the device. The corresponding symbol flashes to indicate the selected tariff.

### 4.5.3. USER

This profile is identified with the **user** symbol on the bottom of the screen (Figure 32).

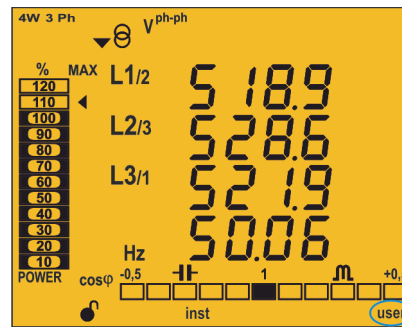

Figure 32: Screen of the CVM-C10 with the user profile.

This profile displays the screens selected in the programming menu (“4.9.12. **Selecting the operation profile**”).

**Note :** If you have not selected the display of any screen, the device will restart and display the **Phase-Neutral Voltage** screen by default.

The voltage and current harmonics are also displayed, up to the 31st order harmonic, for each of the lines, L1, L2 and L3 (“4.6.- **HARMONICS**.”)

### 4.6.- HARMONICS

The device can display the voltage and current harmonics, up to the 31st order harmonic, for each one of the lines, L1, L2 and L3.

The display of these can be deactivated using the programming menu (“4.9.18. **Activating the harmonics display screen**.”).

Press the **>** key on the last profile screen to show all operation profiles on the harmonics display screens.

Harmonics are displayed as shown on Figure 33.

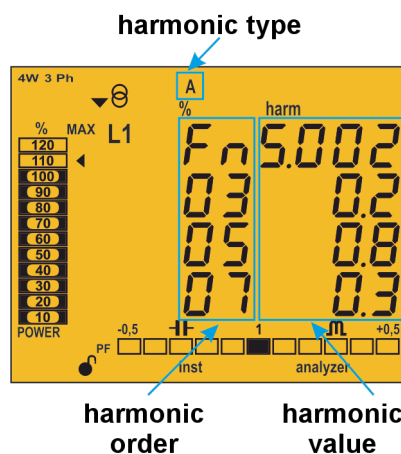



Figure 33: CVM-C10 Current harmonics screen.

Press key **>** to open the next harmonics screen.

Press key  to display the different types of harmonics:

- Voltage harmonics L1- L2 - L3
- Current harmonics L1- L2 -L3

#### 4.7.- INPUTS

The **CVM-C10** has two digital inputs (terminals 12 and 13 on **Figure 1**, **Figure 2** and **Figure 3**) that can be programmed to operate as a logic or tariff selection input.

If configured as a logic input, the device displays the status of that input.

See “**4.9.27. Operating mode of digital input 1**” and “**4.9.28. Operating mode of digital input 2**”

The selected tariff can be determined in accordance with the status of the inputs, as shown in **Table 14**.

Table 14: Selecting the tariff in accordance with the input status.

IN1, Input 1		IN2, Input 2		Tariff
Logic input	Tariff selection	Logic input	Tariff selection	
x		x		T1
x			0	T1
x			1	T3
	0	x		T1
	1	x		T2
	0		0	T1
	0		1	T3
	1		0	T2
	1		1	T1

#### 4.8.- OUTPUTS

The device features:

- ✓ Two alarm relays (terminals 3, 4 and 5, as shown in **Figure 1**, **Figure 2** and **Figure 3**), fully programmable, see “**4.9.23. Programming alarm 1 (Relay 1)**” and “**4.9.24. Programming alarm 2 (Relay 2)**”
- ✓ Two digital outputs, optoisolated NPN transistors (terminals 6, 7 and 8 on **Figure 1** and **Figure 3**), fully programmable, see “**4.9.25. Programming alarm 3 (Digital output T1)**” and “**4.9.26. Programming alarm 4 (Digital output T2)**”.



**Note:** The digital outputs are not available on models **CVM-C10-ITF-IN**, **CVM-C10-MC-IN** and **CVM-C10-FLEX**

## 4.9.- PROGRAMMING

From the programming menu you can:

- ✓ Lock the status of the menu.
- ✓ Define the transformation ratios.
- ✓ Select the number of quadrants and type of installation.
- ✓ Select the operation profile of the device.
- ✓ Program the carbon emission ratio, kgCO<sub>2</sub>.
- ✓ Program the cost ratio.
- ✓ Program the maximum demand parameters.
- ✓ Delete the energy meters and the maximum and minimum values.
- ✓ Modify the display's backlight.
- ✓ Activate the harmonic display option.
- ✓ Program alarms.
- ✓ Program Modbus communications

The programming parameters are validated as follows:

- ✓ When on reaching the last point on the programming menu (“**4.9.30. Locking the programming**”) the key is pressed 
- ✓ At any point in the programming, by pressing the key  or  pressing for 3 seconds.

If the device is RESET before validation or no key is pressed for 30 seconds, the configuration will not be stored in the memory.

To enter the programming menu press the  key for 3 seconds.

The home screen of the menu indicates whether the menu is locked or not:

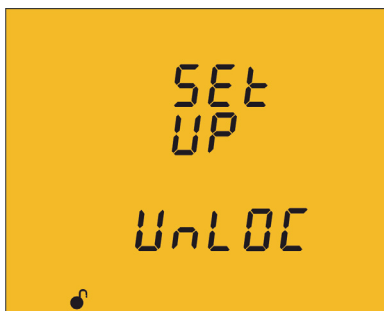

UnLOC

When you enter the programming menu you can view and modify the programming. Icon  on the display indicates that the unit is not locked.

LOC

When you enter the programming you can view the programming but not modify it. Icon  indicates the locking status.

Press key  to access the first programming step.

The following screen will be displayed if the programming menu is locked, LOC:



Enter the password in this screen to modify the programming parameters.

Press key  for 3 seconds to edit the password. The **prog** icon will be displayed on the bottom of the screen.

To enter or modify the value, press the  key repeatedly, increasing the value of the flashing digit.

When the desired value is shown on the screen, move onto the next digit by pressing the key  to modify the other values.

If you press the  key after changing the last digit, it will jump back to the first digit so you can modify the previously programmed values again.

To validate the data, press  for 3 seconds and the **prog** icon will disappear from the display.

If the password is correct, the icon will change its status to not locked .

If you do not enter the password or it is incorrect, you can open the programming menu but it cannot be modified.

The programming menu is unlocked for a short period of time and it will be locked again when you exit the device's menu.

To permanently unlock the device, select the programming parameter **"4.9.30. Locking the programming"**

Press key  to access the next programming step.

**Default password:** 1234.

#### 4.9.1. PRIMARY VOLTAGE



On this screen the voltage transformer primary is programmed.

Press key  for 3 seconds to edit the transformer primary value. The **prog** icon will be displayed on the bottom of the screen.

To enter or modify the value, press the  key repeatedly, increasing the value of the flashing digit.

When the desired value is shown on the screen, move onto the next digit by pressing the key  to modify the other values.

If you press the  key after changing the last digit, it will jump back to the first digit so you can modify the previously programmed values again.

To validate the data, press  for 3 seconds and the **prog** icon will disappear from the display.

The programmed value will be deleted if the entered value is higher than the maximum programming value.

**Maximum programming value:** 599999.

**Minimum programming value:** 1.  
**Voltage ratio x Primary Current** < 600000

**Note:** The ratio is the relation between the primary and the secondary.

Press key  to access the next programming step.

#### 4.9.2. SECONDARY VOLTAGE



On this screen the voltage transformer secondary is programmed. Press key  for 3 seconds to edit the transformer secondary value. The **prog** icon will be displayed on the bottom of the screen.

To enter or modify the value, press the  key repeatedly, increasing the value of the flashing digit.

When the desired value is shown on the screen, move onto the next digit by pressing the key  to modify the other values.

If you press the  key after changing the last digit, it will jump back to the first digit so you can modify the previously programmed values again.

To validate the data, press  for 3 seconds and the **prog** icon will disappear from the display.

The programmed value will be deleted if the entered value is higher than the maximum programming value.

**Maximum programming value:** 999.  
**Minimum programming value:** 1.

Press key  to access the next programming step.

#### 4.9.3. PRIMARY CURRENT



The current transformer primary is programmed on this screen. Press key  for 3 seconds to edit the transformer primary value. The **prog** icon will be displayed on the bottom of the screen.

To enter or modify the value, press the  key repeatedly, increasing the value of the flashing digit.

When the desired value is shown on the screen, move onto the next digit by pressing the key  to modify the remaining values.

If you press the  key after changing the last digit, it will jump back to the first digit so you can modify the previously programmed values again.



To validate the data, press  for 3 seconds and the **prog** icon will disappear from the display.

The programmed value will be deleted if the entered value is higher than the maximum programming value.

**Maximum programming value:** 10000.

**Minimum programming value:** 1.

**Voltage ratio x Current ratio** < 600000

**Note:** The ratio is the relation between the primary and the secondary.

Press key  to access the next programming step

#### 4.9.4. SECONDARY CURRENT ( MODEL CVM-C10-ITF)



On this screen the current transformer secondary is selected.

Press key  for 3 seconds to edit the transformer secondary value. The **prog** icon will be displayed on the bottom of the screen.

Press key  to browse the two possible options for the current transformer secondary (1A or 5A).

To validate the data, press  for 3 seconds and the **prog** icon will disappear from the display.

Press key  to access the next programming step

#### 4.9.5. PRIMARY NEUTRAL CURRENT ( MODELS: CVM-C10-ITF-IN AND CVM-C10-MC-IN)



The neutral current transformer primary is programmed on this screen.

Press key  for 3 seconds to edit the transformer primary value. The **prog** icon will be displayed on the bottom of the screen.

To enter or modify the value, press the  key repeatedly, increasing the value of the flashing digit.

When the desired value is shown on the screen, move onto the next digit by pressing the key  to modify the remaining values.

If you press the  key after changing the last digit, it will jump back to the first digit so you can modify the previously programmed values again.

To validate the data, press  for 3 seconds and the **prog** icon will disappear from the display.

The programmed value will be deleted if the entered value is higher than the maximum programming value.

**Maximum programming value:** 10000.

**Minimum programming value:** 1.

Press key  to access the next programming step

#### 4.9.6. SECONDARY NEUTRAL CURRENT (MODEL CVM-C10-ITF-IN)



The neutral current transformer secondary is programmed on this screen.

Press key  for 3 seconds to edit the transformer secondary value. The **prog** icon will be displayed on the bottom of the screen.

Press key  to browse the two possible options for the current transformer secondary (1A or 5A).

To validate the data, press  for 3 seconds and the **prog** icon will disappear from the display.

Press key  to access the next programming step

#### 4.9.7. NUMBER OF QUADRANTS

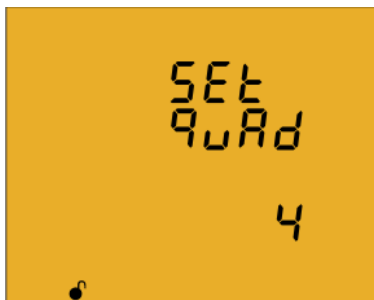

The quadrant number on which the unit takes the measurement is selected on this screen.

Press key  for 3 seconds to edit the number of quadrants. The **prog** icon will be displayed on the bottom of the screen.

Press key  to browse the two options: 2 or 4 quadrants.

To validate the data, press  for 3 seconds and the **prog** icon will disappear from the display.

Press key  to access the next programming step

#### 4.9.8. MEASUREMENT CONVENTION



You can select the measurement convention of the device from this screen.

To edit the measurement convention press key  for 3 seconds. The **prog** icon will be displayed on the bottom of the screen.

The key  is used to browse the different options:

 **Circutor** measurement convention.

 **IEC** measurement convention.

IEEE IEEE measurement convention.

To validate the data, press  for 3 seconds and the **prog** icon will disappear from the display.

Press key  to access the next programming step.

#### 4.9.9. TYPE OF INSTALLATION

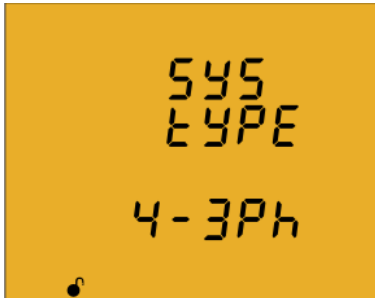

The type of installation is selected on this screen.

Press key  for 3 seconds to edit the type of installation. The **prog** icon will be displayed on the bottom of the screen.

The  key is used to browse the different options

4-3Ph Three-phase network measurement with a 4-wire connection.

3-3Ph Three-phase network measurement with a 3-wire connection.

3-ARON Three-phase network measurement with a 3-wire connection and transformers with an ARON connection .

3-2Ph Two-phase network measurement with a 3-wire connection.

2-2Ph Single-phase network measurement, phase to phase, with a 2-wire connection.

2-1Ph Single-phase network measurement, phase to neutral, with a 2-wire connection.

To validate the data, press  for 3 seconds and the **prog** icon will disappear from the display.

Press key  to access the next programming step.

#### 4.9.10. MAXIMUM DEMAND INTEGRATION PERIOD

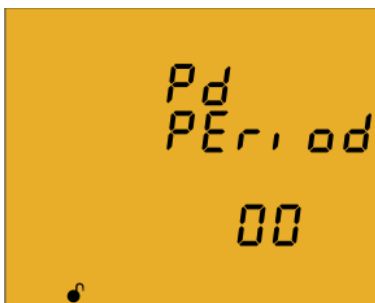

The maximum demand integration period is programmed in minutes on this screen.

Press key  for 3 seconds to edit the integration period value. The **prog** icon will be displayed on the bottom of the screen.

To enter or modify the value, press the  key repeatedly, increasing the value of the flashing digit.

When the desired value is shown on the screen, move onto the next digit by pressing the key  to modify the other values.

If you press the  key after changing the last digit, it will jump back to the first digit so you can modify the previously programmed values again.

To validate the data, press  for 3 seconds and the **prog** icon will disappear from the display.

The programmed value will be deleted if the entered value is higher than the maximum programming value.

**Maximum programming value:** 60.

**Minimum programming value:** 0.

**Note:** Programming the value 0 disables the calculation of the maximum demand.

Press key  to access the next programming step.

#### 4.9.11. DELETING MAXIMUM DEMAND



On this screen you select whether or not to delete the maximum demand.

Press key  for 3 seconds to edit the deletion selection. The **prog** icon will be displayed on the bottom of the screen.

Press key  to browse the two deletion options: Yes or No.

To validate the data, press  for 3 seconds and the **prog** icon will disappear from the display.

Press key  to access the next programming step

#### 4.9.12. SELECTING THE OPERATION PROFILE

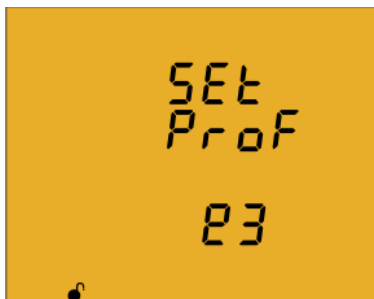

The unit's operation profile is selected on this screen.

Press key  for 3 seconds to edit the operation profile selection. The **prog** icon will be displayed on the bottom of the screen.

Press key  to browse the three profile options:

*ANALY* Analyzer profile, **analyzer**,  
*e3* Electrical energy efficiency profile, **e<sup>3</sup>**,  
*USER* User profile, **user**,

To validate the data, press  for 3 seconds and the **prog** icon will disappear from the display.

Press key  to access the next programming step

### ✓ Selecting the screens that will be displayed (*User profile*)

The following screen is displayed if you have selected the **user** profile:





This screen is used to select whether the unit's display screens are defined by the user or not.

Press key  for 3 seconds to edit the selection. The **prog** icon will be displayed on the bottom of the screen.

Press key  to browse the two profile options:

**YES** the display screens are those that were stored in previous programming settings of the device. (In the case of new devices, these will be the same as those of the **analyzer** profile)  
**NO**, the display screens are selected.

To validate the data, press  for 3 seconds and the **prog** icon will disappear from the display.

Press key  to access the next programming step

### ✓ Selecting the screens

The following screen will be displayed if you have selected **NO** :

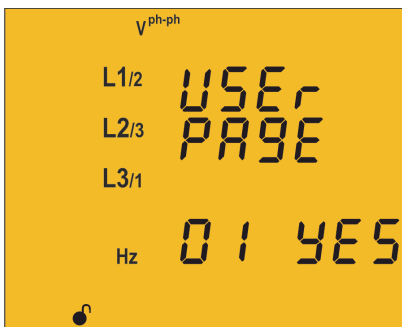

This screen displays the first screen of the **analyzer** profile, *Phase-phase Voltage* and the **user** profile viewing option can be selected.

Press key  for 3 seconds to edit the selection. The **prog** icon will be displayed on the bottom of the screen.

Press key  to browse the two options:

**YES**, to display the screen in the user menu.  
**NO**, to stop displaying the screen.

To validate the data, press  for 3 seconds and the **prog** icon will disappear from the display.

Press key  to access the next programming step

***This programming step is repeated for each one of the 18 screens of the device.***

#### 4.9.13. BACKLIGHT, TURNING ON THE BACKLIT DISPLAY





The time that the Backlight will stay lit (in seconds) is programmed on this screen after the last keystroke on the unit .

Press key  for 3 seconds to edit the backlight value. The **prog** icon will be displayed on the bottom of the screen.

To enter or modify the value, press the  key repeatedly, increasing the value of the flashing digit.

When the desired value is shown on the screen, move onto the next digit by pressing the key  to modify the other values.

If you press the  key after changing the last digit, it will jump back to the first digit so you can modify the previously programmed values again.

To validate the data, press  for 3 seconds and the **prog** icon will disappear from the display.

**Maximum programming value:** 99 seconds.

**Minimum programming value:** 0 seconds.

**Note:** The value **00** indicates that the backlight will stay permanently lit.

Press key  to access the next programming step.

#### 4.9.14. SELECTING THE Cos $\phi$ - PF BAR ON THE DISPLAY

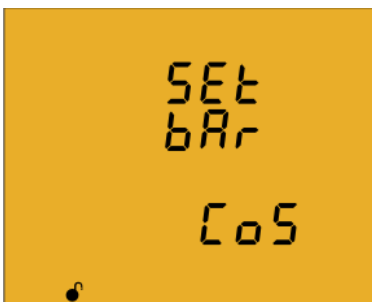

This screen is used to select the Cos  $\phi$  - PF bar viewing option.

Press key  for 3 seconds to edit the selection. The **prog** icon will be displayed on the bottom of the screen.

Press key  to browse the two viewing options.

**Cos** Displaying the Cos  $\phi$ .  
**PF** Displaying the Power Factor

To validate the data, press  for 3 seconds and the **prog** icon will disappear from the display.

Press key  to access the next programming step.

#### 4.9.15. DELETING MAXIMUM AND MINIMUM VALUES



On this screen you select whether or not to delete the maximum and minimum values

Press key  for 3 seconds to edit the selection. The **prog** icon will be displayed on the bottom of the screen.

Press key  to browse the two options (Yes and No).

To validate the data, press  for 3 seconds and the **prog** icon will disappear from the display.

Press key  to access the next programming step.

#### 4.9.16. DELETING ENERGY VALUES



On this screen you select whether or not to delete the energy values

Press key  for 3 seconds to edit the selection. The **prog** icon will be displayed on the bottom of the screen.

Press key  to browse the two options (Yes and No).

To validate the data, press  for 3 seconds and the **prog** icon will disappear from the display.

Press key  to access the next programming step.

#### 4.9.17. SELECTING THE RANGE OF ENERGIES



The operation of the range of energy is selected on this screen.

Press key  for 3 seconds to edit the selection. The **prog** icon will be displayed on the bottom of the screen.

Press the  key to browse different options:

**AUTO** The device displays the kWh and MWh. When the energy value reaches 999999kWh, the device automatically selects the MWh range.

**SHORT** The device only displays the kWh. When the energy value reaches 999999kWh, the device resets the measurement to 0kWh.

**To validate the modification of the range of energies, delete the energy values first.**

To do so, press the  validation key for 3 seconds; the energy value deletion screen will be displayed. Select YES to delete the energy values; the device will go back to the energy range selection screen.

To complete the validation, press the  key for 3 seconds; the prog icon will disappear from the display.

Press key  to access the next programming step.

#### 4.9.18. ACTIVATING THE HARMONICS DISPLAY SCREEN.



This screen is used to select whether harmonics are displayed or not.

Press key  for 3 seconds to edit the selection. The **prog** icon will be displayed on the bottom of the screen.

Press key  to browse the two options (Yes and No).

To validate the data, press  for 3 seconds and the **prog** icon will disappear from the display.

Press key  to access the next programming step.

#### 4.9.19. kgCO<sub>2</sub> CARBON EMISSION RATIO OF GENERATED ENERGY

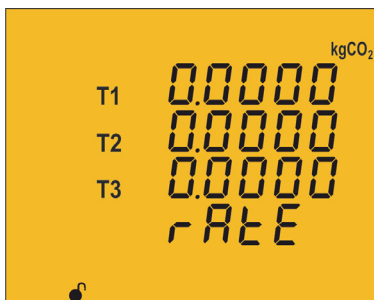



The carbon emissions ratio is the amount of emissions released into the atmosphere to produce a unit of electricity (1 kWh).

The ratio for the European mix is approximately 0.65 kgCO<sub>2</sub> per kWh.

Press key  for 3 seconds to edit the emission ratio selection. The **prog** icon will be displayed on the bottom of the screen.

The emission ratio of the 3 tariffs of the device, T1, T2 and T3, is programmed on this screen.

To enter or modify the value, press the  key repeatedly, increasing the value of the flashing digit.

When the desired value is shown on the screen, move onto the next digit by pressing the key  to modify the other values.

If you press the  key after changing the last digit, it will jump back to the first digit so you can modify the previously programmed values again.

Press key  to browse the different tariffs.

To validate the data, press  for 3 seconds and the **prog** icon will disappear from the display.

The programmed value will be deleted if the entered value is higher than the maximum programming value.

**Maximum programming value:** 1.9999.

**Minimum programming value:** 0.



Press key  to access the next programming step.

#### 4.9.20. kgCO<sub>2</sub> CARBON EMISSION RATIO OF CONSUMED ENERGY

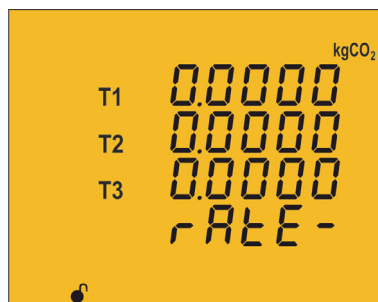



The carbon emissions ratio is the amount of emissions released into the atmosphere to produce a unit of electricity (1 kWh). The ratio for the European mix is approximately 0.65 kgCO<sub>2</sub> per kWh.

Press key  for 3 seconds to edit the emission ratio selection. The **prog** icon will be displayed on the bottom of the screen.

The emission ratio of the 3 tariffs of the device, T1, T2 and T3, is programmed on this screen.

To enter or modify the value, press the  key repeatedly, increasing the value of the flashing digit.

When the desired value is shown on the screen, move onto the next digit by pressing the key  to modify the other values.

If you press the  key after changing the last digit, it will jump back to the first digit so you can modify the previously programmed values again.

Press key  to browse the different tariffs.

To validate the data, press  for 3 seconds and the **prog** icon will disappear from the display.

The programmed value will be deleted if the entered value is higher than the maximum programming value.

**Maximum programming value:** 1.9999.

**Minimum programming value:** 0.

Press key  to access the next programming step.

#### 4.9.21. COST RATIO OF GENERATED ENERGY



The cost per kWh of electricity of the three tariffs of the unit is calculated on this screen.

Press key  for 3 seconds to edit the cost ratio selection. The **prog** icon will be displayed on the bottom of the screen.

To enter or modify the value, press the  key repeatedly, increasing the value of the flashing digit.

When the desired value is shown on the screen, move onto the next digit by pressing the key

➤ to modify the other values.

If you press the ➤ key after changing the last digit, it will jump back to the first digit so you can modify the previously programmed values again.

Press key ⬅ to browse the different tariffs.

To validate the data, press ☰ for 3 seconds and the **prog** icon will disappear from the display.

The programmed value will be deleted if the entered value is higher than the maximum programming value.

**Maximum programming value:** 1.9999.

**Minimum programming value:** 0.

Press key ➤ to access the next programming step.

#### 4.9.22. COST RATIO OF CONSUMED ENERGY

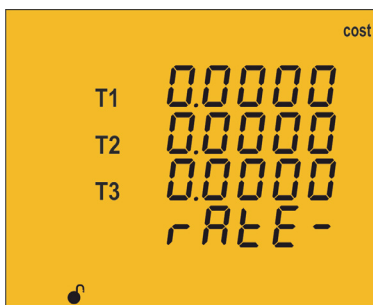

The cost per kWh of electricity of the three tariffs of the unit is calculated on this screen.

Press key ☰ for 3 seconds to edit the cost ratio selection. The **prog** icon will be displayed on the bottom of the screen.

To enter or modify the value, press the ☰ key repeatedly, increasing the value of the flashing digit.

When the desired value is shown on the screen, move onto the next digit by pressing the key ➤ to modify the other values.

If you press the ➤ key after changing the last digit, it will jump back to the first digit so you can modify the previously programmed values again.

Press key ⬅ to browse the different tariffs.

To validate the data, press ☰ for 3 seconds and the **prog** icon will disappear from the display.

The programmed value will be deleted if the entered value is higher than the maximum programming value.

**Maximum programming value:** 1.9999.

**Minimum programming value:** 0.

Press key ➤ to access the next programming step.

#### 4.9.23. PROGRAMMING ALARM 1 (RELAY 1)

**Note :** Configuration parameters not available for the **CVM-C10-FLEX** model.

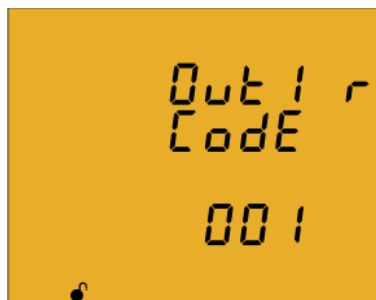

The variable code is selected on this screen, depending on **Table 15**, which will control alarm relay 1.

Press key  for 3 seconds to edit the code selection. The **prog** icon will be displayed on the bottom of the screen.



To enter or modify the value, press the  key repeatedly, increasing the value of the flashing digit.

When the desired value is shown on the screen, move onto the next digit by pressing the key  to modify the other values.

When you enter the code of a variable on the display, the symbols for that variable will be activated.

Set the value to 00 if you do not wish to program a variable.

If you press the  key after changing the last digit, it will jump back to the first digit so you can modify the previously programmed values again.

To validate the data, press  for 3 seconds and the **prog** icon will disappear from the display. Press key  to access the next programming step.

**Table 15: Parameter codes used to program the outputs.**

Parameter	Phase	Code	Phase	Code	Phase	Code	Phase	Code
Phase-Neutral Voltage	L1	01	L2	09	L3	17	-	-
Current	L1	02	L2	10	L3	18	-	-
Active power	L1	03	L2	11	L3	19	III	25
Inductive Reactive Power	L1	04	L2	12	L3	20	III	26
Capacitive Reactive Power	L1	05	L2	13	L3	21	III	27
Apparent power	L1	06	L2	14	L3	22	III	28
Power factor	L1	07	L2	15	L3	23	III	29
Cosine $\varphi$	L1	08	L2	16	L3	24	III	30
% THD V	L1	36	L2	37	L3	38	-	-
% THD A	L1	39	L2	40	L3	41	-	-
Phase-Phase Voltage	L1/2	32	L2/3	33	L3/1	34	-	-
Frequency	-	31	-	-	-	-	-	-
Neutral current	-	35	-	-	-	-	-	-
Maximum current demand	L1	45	L2	46	L3	47	III	44
Active Power Maximum Demand	-	-	-	-	-	-	III	42
Apparent Power Maximum Demand	-	-	-	-	-	-	III	43

Table 15 (Continuation) : Parameter codes used to program the outputs.

Parameter	Phase	Code	Phase	Code	Phase	Code	Phase	Code
Inductive Reactive Power Maximum Demand	-	-	-	-	-	-	III	132
Capacitive Reactive Power Maximum Demand	-	-	-	-	-	-	III	133

In addition, there are some parameters (Table 16) that refer to the three phases at the same time (OR function). If you have selected one of these variables, the alarm will be activated when any of the three phases meets the programmed conditions.

Table 16: Multiple parameter codes for alarm programming.

Types of parameters	Code
Phase-Neutral Voltage	200
Current	201
Active power	202
Inductive Reactive Power	203
Capacitive Reactive Power	204
Power factor	205
Phase-Phase Voltage	206
% THD V	207
% THD A	208
Apparent Power	209

✓ **Programming the maximum value**

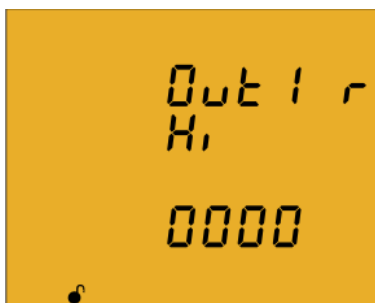





The **maximum value**: the alarm is activated when this value is exceeded.

Press key  for 3 seconds to edit the maximum value selection. The **prog** icon will be displayed on the bottom of the screen.

To enter or modify the value, press the  key repeatedly, increasing the value of the flashing digit.

When the desired value is shown on the screen, move onto the next digit by pressing the key  to modify the other values.

In the case of some parameters (Table 17), you can modify the position of the decimal point. To do so, press key  after modifying the last digit and the decimal point will start flashing. Press key  repeatedly to modify the position of the decimal point.

When the decimal point is in the desired position, press the key  to end the programming, pressing now the key  we can set a positive or negative value.

**Note:** Pay special attention when programming the Generation Power (displayed with negative values).

**Example:** If you wish to enter a generation power alarm with limits between 2 kW and 1 kW, program the following as the **maximum value** : - 1 kW and the following as the **minimum value** : - 2 kW.





To validate the data, press  for 3 seconds and the **prog** icon will disappear from the display. Press key  to access the next programming step

Table 17: Decimal point and units of the alarm parameters.



Types of parameters	Units	Decimal point
Voltage	2000 V 200.0 V 20.00 kV 2.000 kV	Programmable
Current	A	Programmable
Frequency	Hz	Fixed
Power	kW	Programmable
Power factor	PF	Fixed
Cosine $\varphi$	$\varphi$	Fixed
Maximum current demand	A	Programmable
Maximum power demand	kW	Programmable
THD	%	Fixed



#### ✓ Programming the minimum value



The **minimum value**: the alarm is activated below this value. Press key  for 3 seconds to edit the minimum value selection. The **prog** icon will be displayed on the bottom of the screen. To enter or modify the value, press the  key repeatedly, increasing the value of the flashing digit.



When the desired value is shown on the screen, move onto the next digit by pressing the key  to modify the other values.

In the case of some parameters (Table 17) you can modify the position of the decimal point. To do so, press key  after modifying the last digit and the decimal point will start flashing. Press key  repeatedly to modify the position of the decimal point.

When the decimal point is in the desired position, press the key  to end the programming, pressing now the key  we can set a positive or negative value.

**Note:** Pay special attention when programming the Generation Power (displayed with negative values).

**Example:** If you wish to enter a generation power alarm with limits between 2 kW and 1 kW, program the following as the **maximum value** : - 1 kW and the following as the **minimum value** : - 2 kW.

To validate the data, press  for 3 seconds and the **prog** icon will disappear from the display. Press key  to access the next programming step.

### ✓ Programming the connection time delay



The alarm connection delay is programmed on this screen in seconds.

Press key  for 3 seconds to edit the delay selection. The **prog** icon will be displayed on the bottom of the screen.

To enter or modify the value, press the  key repeatedly, increasing the value of the flashing digit.

When the desired value is shown on the screen, move onto the next digit by pressing the key  to modify the other values.

If you press the  key after changing the last digit, it will jump back to the first digit so you can modify the previously programmed values again.

To validate the data, press  for 3 seconds and the **prog** icon will disappear from the display.

Press key  to access the next programming step.

### ✓ Programming the hysteresis value

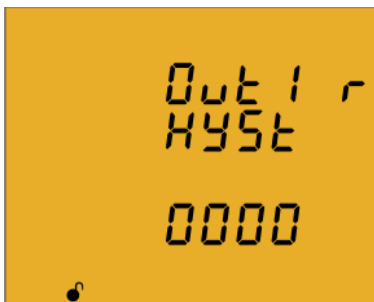



The hysteresis value, i.e., difference between the alarm connection and disconnection value, in %, is programmed on this screen.

Press key  for 3 seconds to edit the hysteresis value selection. The **prog** icon will be displayed on the bottom of the screen.

To enter or modify the value, press the  key repeatedly, increasing the value of the flashing digit.

When the desired value is shown on the screen, move onto the next digit by pressing the key  to modify the other values.

If you press the  key after changing the last digit, it will jump back to the first digit so you can modify the previously programmed values again.

To validate the data, press  for 3 seconds and the **prog** icon will disappear from the display. Press key  to access the next programming step.

### ✓ Programming the latch



The interlocking is selected on this screen, i.e., if the alarm is interlocked after it has been tripped, even when the condition that triggered it has disappeared.

Press key  for 3 seconds to edit the selection. The **prog** icon will be displayed on the bottom of the screen.

Press key  to browse the two options (Yes and No).

To validate the data, press  for 3 seconds and the **prog** icon will disappear from the display.

Press key  to access the next programming step.

**Note:** If the device is reset, the status of alarms is deleted and all alarms will return to the programmed standby status, provided that the condition that triggered them has been resolved.

### ✓ Programming the time delay 2





The alarm disconnection delay is programmed on this screen in seconds.

Press key  for 3 seconds to edit the maximum value selection. The **prog** icon will be displayed on the bottom of the screen.

To enter or modify the value, press the  key repeatedly, increasing the value of the flashing digit.

When the desired value is shown on the screen, move onto the next digit by pressing the key  to modify the other values.

If you press the  key after changing the last digit, it will jump back to the first digit so you can modify the previously programmed values again.

To validate the data, press  for 3 seconds and the **prog** icon will disappear from the display.

Press key  to access the next programming step.

### ✓ Programming the contact status



The status of relay contacts is selected on this screen.

Press key  for 3 seconds to edit the selection. The **prog** icon will be displayed on the bottom of the screen.

Press key  to browse the two options:

**NO** Normally open contact.  
**NC** Normally closed contact.



To validate the data, press  for 3 seconds and the **prog** icon will disappear from the display.

Press key  to access the next programming step

#### 4.9.24. PROGRAMMING ALARM 2 (RELAY 2)

**Note :** Configuration parameters not available for the **CVM-C10-FLEX** model.





The values for alarm relay 2 are programmed on this screen. They are programmed as in the case of alarm relay 1, see “4.9.23. Programming alarm 1 (Relay 1)”

#### 4.9.25. PROGRAMMING ALARM 3 (DIGITAL OUTPUT T1)

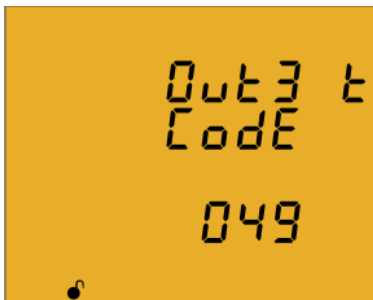
**Note :** Configuration parameters not available for the **CVM-C10-FLEX**, **CVM-C10-ITF-IN** and **CVM-C10-MC-IN** models.



All values for digital output T1 are programmed on this screen. The variable code is selected on this screen, depending on **Table 15** and **Table 18**, which will control digital output T1. Press key  for 3 seconds to edit the code selection. The **prog** icon will be displayed on the bottom of the screen.

Press key  for 3 seconds to edit the code selection. The **prog** icon will be displayed on the bottom of the screen.

To enter or modify the value, press the  key repeatedly, increasing the value of the flashing digit.

When the desired value is shown on the screen, move onto the next digit by pressing the key  to modify the other values.

When you enter the code of a variable on the display, the symbols for that variable will be activated.

Set the value to **00** if you do not wish to program a variable.

If you press the  key after changing the last digit, it will jump back to the first digit so you can modify the previously programmed values again.



To validate the data, press  for 3 seconds and the **prog** icon will disappear from the display. Press key  to access the next programming step



Table 18: Parameter codes used to program digital outputs.

Parameter	Tariff	Code	Tariff	Code	Tariff	Code	Tariff	Code
Consumed Active Energy	T1	49	T2	70	T3	91	total	112
Generated Active Energy	T1	59	T2	80	T3	101	total	122
Consumed Inductive Reactive Energy	T1	51	T2	72	T3	93	total	114
Generated Inductive Reactive Energy	T1	61	T2	82	T3	103	total	124
Consumed Capacitive Reactive Energy	T1	53	T2	74	T3	95	total	116
Generated Capacitive Reactive Energy	T1	63	T2	84	T3	105	total	126
Consumed Apparent Energy	T1	55	T2	76	T3	97	total	118
Generated Apparent Energy	T1	65	T2	86	T3	107	total	128
Consumed CO <sub>2</sub> Emissions	T1	56	T2	77	T3	98	total	119
Generated CO <sub>2</sub> Emissions	T1	66	T2	87	T3	108	total	129
Consumption Cost	T1	57	T2	78	T3	99	total	120
Generation Cost	T1	67	T2	88	T3	109	total	130
No. of hours	T1	68	T2		T3	110	total	131

If you have selected a parameter from **Table 12** the subsequent programming steps are the same as for alarm relay 1, see (“4.9.23. **Programming alarm 1 (Relay 1)**”)

If you have selected a parameter from **Table 18**, the subsequent programming steps are:

#### ✓ Programming kilowatts per pulse

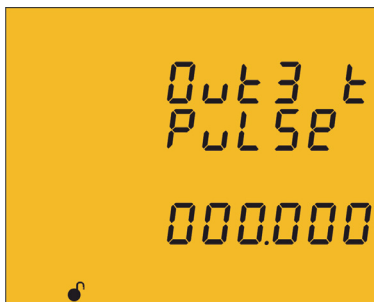

Press key  for 3 seconds to edit the kilowatts per pulse selection. The **prog** icon will be displayed on the bottom of the screen.

To enter or modify the value, press the  key repeatedly, increasing the value of the flashing digit.

When the desired value is shown on the screen, move onto the next digit by pressing the key  to modify the other values.

If you press the  key after changing the last digit, it will jump back to the first digit so you can modify the previously programmed values again.

To validate the data, press  for 3 seconds and the **prog** icon will disappear from the display.

Press key  to access the next programming step.

The programmed value will be deleted if the entered value is higher than the maximum programming value.

**Maximum programming value:** 999.999 KWh

**Minimum programming value:** 000.001 KWh

**Example:** To program 500 Wh per pulse: 000.500  
 To program 1.5 kWh per pulse: 001.500

✓ **Programming the pulse width**





The width of the pulse is selected on this screen in ms. Press key  for 3 seconds to edit the pulse width selection. The **prog** icon will be displayed on the bottom of the screen.

To enter or modify the value, press the  key repeatedly, increasing the value of the flashing digit.

When the desired value is shown on the screen, move onto the next digit by pressing the key  to modify the other values.

If you press the  key after changing the last digit, it will jump back to the first digit so you can modify the previously programmed values again.

To validate the data, press  for 3 seconds and the **prog** icon will disappear from the display.

Press key  to access the next programming step. The programmed value will be deleted if the entered value is higher than the maximum programming value.

**Maximum programming value:** 500 ms.  
**Minimum programming value:** 30 ms.

**4.9.26. PROGRAMMING ALARM 4 (DIGITAL OUTPUT T2)**

**Note :** Configuration parameters not available for the **CVM-C10-FLEX, CVM-C10-ITF-IN and CVM-C10-MC-IN** models.



All values for digital output T2 are programmed on this screen.

They are programmed as in the case of digital output T1, see "4.9.25. Programming alarm 3 (Digital output T1)"

#### 4.9.27. OPERATING MODE OF DIGITAL INPUT 1



The function of digital input 1 is selected on this screen.

Press key  for 3 seconds to edit the function selection. The **prog** icon will be displayed on the bottom of the screen.

Press key  to browse the two options:

LoG, c Logic input  
tAr, FF Tariff selection.

To validate the data, press  for 3 seconds and the **prog** icon will disappear from the display.

Press key  to access the next programming step.

#### 4.9.28. OPERATING MODE OF DIGITAL INPUT 2



The function of digital input 2 is selected on this screen.

Press key  for 3 seconds to edit the function selection. The **prog** icon will be displayed on the bottom of the screen.

Press key  to browse the two options:

LoG, c Logic input  
tAr, FF Tariff selection.

To validate the data, press  for 3 seconds and the **prog** icon will disappear from the display.

Press key  to access the next programming step.

#### 4.9.29. RS-485 COMMUNICATIONS: PROTOCOL

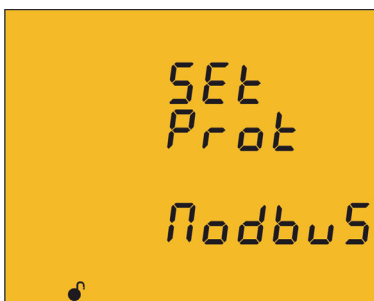

The RS-485 communications protocol is selected on this screen.

Press the  key for 3 seconds to edit the function selection. The **prog** icon will be displayed on the bottom of the screen.

Press key  to browse the two options:

**Modbus**  
**BACnet**

To validate the data, press  for 3 seconds and the **prog** icon will disappear from the display.

Press key  to access the next programming step.

**Note:** The device will restart after exiting the setup menu if the RS-485 communications parameters have been modified.

### 4.9.29.1 Modbus protocol

#### ✓ Transmission speed



The transmission speed of modbus communications is programmed on this screen.

Press key  for 3 seconds to edit the transmission speed selection. The **prog** icon will be displayed on the bottom of the screen.

Press key  to browse the two options: **9600** or **19200**.

To validate the data, press  for 3 seconds and the **prog** icon will disappear from the display.

Press key  to access the next programming step.

#### ✓ Peripheral number



The peripheral number is programmed on this screen.

Press key  for 3 seconds to edit the peripheral number selection. The **prog** icon will be displayed on the bottom of the screen.

To enter or modify the value, press the  key repeatedly, increasing the value of the flashing digit.

When the desired value is shown on the screen, move onto the next digit by pressing the key  to modify the other values.

If you press the  key after changing the last digit, it will jump back to the first digit so you can modify the previously programmed values again.

The peripheral number ranges from 0 to 255.

To validate the data, press  for 3 seconds and the **prog** icon will disappear from the display.

Press key  to access the next programming step.

#### ✓ Parity



The type of parity of Modbus communications is selected on this screen.

Press key  for 3 seconds to edit the parity type selection. The **prog** icon will be displayed on the bottom of the screen.

Press key  to browse the options:

**no**      no parity

*Even* even parity.  
*odd* odd parity.

To validate the data, press  for 3 seconds and the **prog** icon will disappear from the display.

Press key  to access the next programming step.

#### ✓ Number of data bits



The number of data bits of Modbus communications are programmed on this screen.

Press key  for 3 seconds to edit the bit number selection. The **prog** icon will be displayed on the bottom of the screen.

Press key  to browse the two options: **7** or **8** bits.

To validate the data, press  for 3 seconds and the **prog** icon will disappear from the display.

Press key  to access the next programming step.

#### ✓ Number of Stop bits



The number of Stop bits of Modbus communications are programmed on this screen.

Press key  for 3 seconds to edit the Stop bits number selection. The **prog** icon will be displayed on the bottom of the screen.

Press key  to browse the options: **1** or **2** bits.

To validate the data, press  for 3 seconds and the **prog** icon will disappear from the display.

Press key  to access the next programming step.

### 4.9.29.2 BACnet protocol

**Note :** Protocol available in devices with version 3.00 or higher.

#### ✓ Transmission speed



The transmission speed of BACnet communications is programmed on this screen.

Press key  for 3 seconds to edit the transmission speed selection. The **prog** icon will be displayed on the bottom of the screen.

Press key  to browse the two options: **9600** or **19200**.

To validate the data, press  for 3 seconds and the **prog** icon will disappear from the display.

Press key  to access the next programming step.

#### ✓ Device ID



The device ID is programmed on this screen.

Press the  key for 3 seconds to edit the value. The **prog** icon will be displayed on the bottom of the screen.



To enter or modify the value, press the  key repeatedly, increasing the value of the flashing digit.

When the desired value is shown on the screen, press the  key to go to the next digit and modify the other values.

If you press the  key after changing the last digit, it will jump back to the first digit so you can modify the previously programmed values again.

**Maximum programming value:** 999999.

**Minimum programming value:** 0.

To validate the data, press  for 3 seconds and the **prog** icon will disappear from the display. Press key  to access the next programming step.

## ✓ MAC



The MAC address is programmed on this screen.

Press the  key for 3 seconds to edit the value. The **prog** icon will be displayed on the bottom of the screen.



To enter or modify the value, press the  key repeatedly, increasing the value of the flashing digit.

When the desired value is shown on the screen, press the  key to go to the next digit and modify the other values.

If you press the  key after changing the last digit, it will jump back to the first digit so you can modify the previously programmed values again.

**Maximum programming value:** 255.

**Minimum programming value:** 0.

To validate the data, press  for 3 seconds and the **prog** icon will disappear from the display. Press key  to access the next programming step.

### 4.9.30. LOCKING THE PROGRAMMING



This screen is for protecting the data configured in the programming menu.

Press key  for 3 seconds to edit the locking/unlocking selection. The **prog** icon will be displayed on the bottom of the screen.

Press key  to browse the two options:

**unLo**

When you enter the programming menu you can view and modify the programming. Icon  on the display indicates the permanently locked status.

**Loc**

When you enter the programming you can view the programming but not modify it. Icon  indicates the locking status. Enter the password to modify the programming values.

To validate the data, press  for 3 seconds and the **prog** icon will disappear from the display.

Press the  key to enter the password for locking and unlocking the programming:





On this screen you enter the password for locking and unlocking the programming.

Press key  for 3 seconds to edit the password selection. The **prog** icon will be displayed on the bottom of the screen.

To enter or modify the value, press the  key repeatedly, increasing the value of the flashing digit.

When the desired value is shown on the screen, move onto the next digit by pressing the key  to modify the other values.

If you press the  key after changing the last digit, it will jump back to the first digit so you can modify the previously programmed values again.

To validate the data, press  for 3 seconds and the **prog** icon will disappear from the display.

**Default password:** 1234.

This value may only be modified through communications. See “**4.10.3.8.17. Password configuration.**”

Press the  key to exit the setup menu.

**Note:** *The device will restart after exiting the setup menu if the RS-485 communications parameters have been modified.*



## 4.10.- COMMUNICATIONS

The **CVM-C10** devices have one RS-485 communications port.

The device has as standard two communications protocols: **MODBUS RTU**® and **BACnet**.

The protocol and configuration parameters are selected in the setup menu. (“**4.9.29. RS-485 communications: Protocol**”)

**Note:** *BACnet protocol available in devices with version 3.00 or higher.*

### 4.10.1. CONNECTIONS

The RS -485 cable must be wired with twisted pair cable with mesh shield (minimum 3 wires), with a maximum distance between the **CVM-C10** and the master device of 1200 metres. A maximum of 32 **CVM-C10** devices can be connected to this bus.

Use an intelligent RS-232 to RS-485 network protocol converter to establish the communications with the master device.

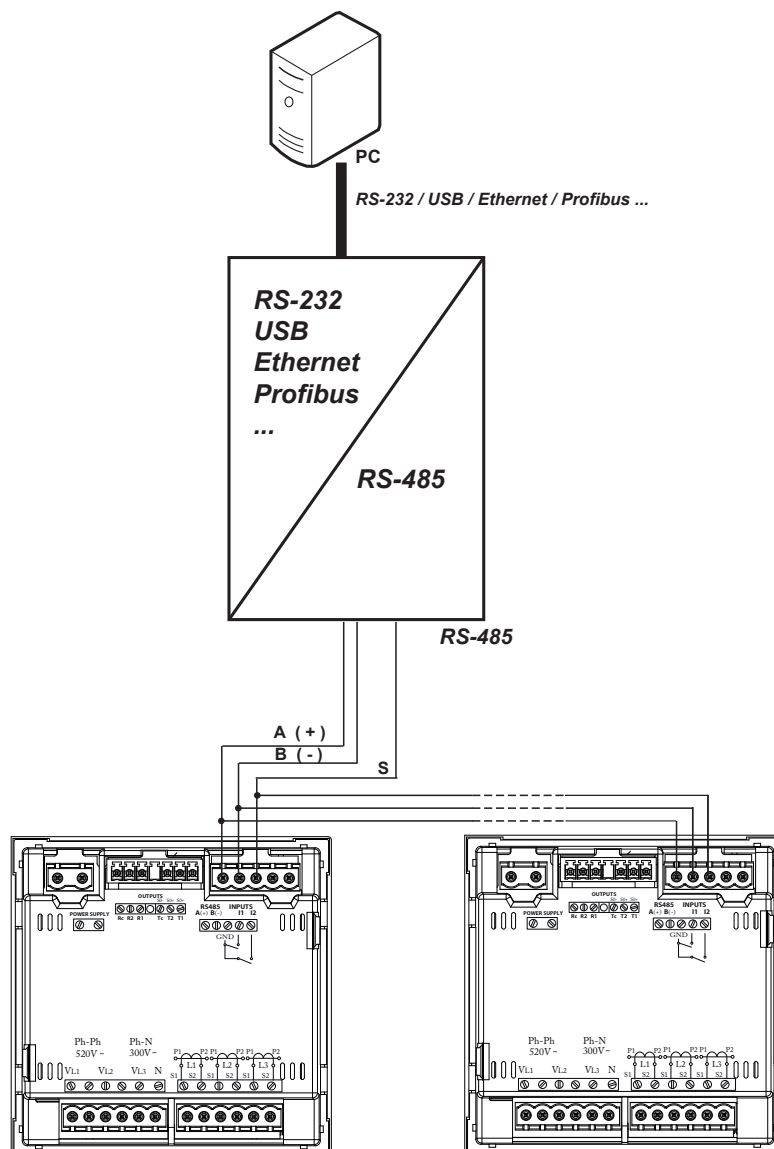

Figure 34: RS-485 Connection diagram.

### 4.10.2. PROTOCOL

In the Modbus protocol, the **CVM-C10** device uses the RTU (Remote Terminal Unit) mode.

The Modbus functions implemented in the device are as follows:

**Function 0x03 and 0x04:** Reading integer logs.

**Function 0x05:** Writing a relay.

**Function 0x10:** Writing multiple logs.

#### 4.10.2.1 Reading example : Function 0x04.

**Question:** Instantaneous value of the phase voltage of L1

Address	Function	Initial Register	No. of Registers	CRC
0A	04	0000	0002	70B0

**Address: 0A,** Peripheral number: 10 in decimals.

**Function: 04,** Read function.

**Initial Register: 0000,** on which the reading will start.

**No. of Registers: 0002,** number of registers read.

**CRC: 70B0,** CRC Character.

**Response:**

Address	Function	No. of Bytes	Register No. 1	Register No. 2	CRC
0A	04	04	0000	084D	8621

**Address: 0A,** Responding peripheral number: 10 in decimals.

**Function: 04,** Read function.

**No. of bytes: 04,** No. of bytes received.

**Registers: 0000084D,** value of the phase voltage of L1: VL1 x 10 : 212.5V

**CRC: 8621,** CRC Character.

**Note :** Every Modbus frame has a maximum limit of 20 variables (40 logs).

#### 4.10.2.2. Writing example: 0x05 function.

**Question:** Deleting maximum and minimum values.

Address	Function	Initial Register	Value	CRC
0A	05	0834	FF00	CEEF

**Address: 0A,** Peripheral number: 10 in decimal.

**Function: 05,** Read function.

**Initial Register: 0834,** Register of the parameter for deleting maximum and minimum values.

**Value: FF00,** we indicate that we want to delete the maximum and minimum values.

**CRC: CEEF**, CRC character.

**Response:**

Address	Function	Initial Register	Value	CRC
0A	05	0834	FF00	CEEF

### 4.10.3. MODBUS COMMANDS

#### 4.10.3.1. Measurement variables.

All the addresses of Modbus memory are in Hexadecimal.

For these variables is implemented the **Function 0x03** and **0x04**.

Table 19: Modbus memory map (Table 1)

Parameter	Symbol	Instantaneous	Maximum	Minimum	Units
L1 Phase voltage	V 1	00-01	106-107	164-165	V x 10
L1 Current	A 1	02-03	108-109	166-167	mA
L1 Active Power	kW 1	04-05	10A-10B	168-169	W
L1 Inductive Power	kvarL 1	06-07	10C-10D	16A-16B	var
L1 Capacitive Power	kvarC 1	08-09	10E-10F	16C-16D	var
L1 Apparent Power	kVA 1	0A-0B	110-111	16E-16F	VA
L1 Power Factor	PF 1	0C-0D	112-113	170-171	x 100
Cos $\varphi$ L1	Cos $\varphi$ 1	0E-0F	114-115	172-173	x 100
L2 Phase voltage	V 2	10-11	116-117	174-175	V x 10
L2 Current	A 2	12-13	118-119	176-177	mA
L2 Active Power	kW 2	14-15	11A-11B	178-179	W
L2 Inductive Power	kvarL 2	16-17	11C-11D	17A-17B	var
L2 Capacitive Power	kvarC 2	18-19	11E-11F	17C-17D	var
L2 Apparent Power	kVA 2	1A-1B	120-121	17E-17F	VA
L2 Power Factor	PF 2	1C-1D	122-123	180-181	x 100
Cos $\varphi$ L2	Cos $\varphi$ 2	1E-1F	124-125	182-183	x 100
L3 Phase voltage	V 3	20-21	126-127	184-185	V x 10
L3 Current	A 3	22-23	128-129	186-187	mA
L3 Active Power	kW 3	24-25	12A-12B	188-189	W
L3 Inductive Power	kvarL 3	26-27	12C-12D	18A-18B	var
L3 Capacitive Power	kvarC 3	28-29	12E-12F	18C-18D	var
L3 Apparent Power	kVA 3	2A-2B	130-131	18E-18F	VA
L3 Power Factor	PF 3	2C-2D	132-133	190-191	x 100
Cos $\varphi$ L3	Cos $\varphi$ 3	2E-2F	134-135	192-193	x 100
Active Three-phase Power	kW III	30-31	136-137	194-195	W
Inductive Three-phase power	kvarL III	32-33	138-139	196-197	var
Capacitive Three-phase Power	kvarC III	34-35	13A-13B	198-199	var
Apparent three-phase power	kVA III	36-37	13C-13D	19A-19B	VA
Three-phase Power Factor	PF III	38-39	13E-13F	19C-19D	x100
Three-phase Cos $\varphi$	Cos $\varphi$ III	3A-3B	140-141	19E-19F	x100
L1 Frequency	Hz	3C-3D	142-143	1A0-1A1	Hz x100
L1-L2 Voltage	V12	3E-3F	144-145	1A2-1A3	V x 10
L2-L3 Voltage	V23	40-41	146-147	1A4-1A5	V x 10
L3-L1 Voltage	V31	42-43	148-149	1A6-1A7	V x 10

**Table 19 (Continuation) : Modbus memory map (Table 1)**

Parameter	Symbol	Instantaneous	Maximum	Minimum	Units
Neutral Current N	A N	44-45	14A-14B	1A8-1A9	mA
L1 voltage % THD	%THDV1	46-47	14C-14D	1AA-1AB	% x 10
L2 voltage % THD	%THDV2	48-49	14E-14F	1AC-1AD	% x 10
L3 voltage % THD	%THDV3	4A-4B	150-151	1AE-1AF	% x 10
L1 current % THD	%THDI1	4C-4D	152-153	1B0-1B1	% x 10
L2 current % THD	%THDI2	4E-4F	154-155	1B2-1B3	% x 10
L3 current % THD	%THDI3	50-51	156-157	1B4-1B5	% x 10
Maximum demand kW III	Md (Pd)	52-53	158-159	-	W
Maximum demand kVA III	Md (Pd)	54-55	15A-15B	-	VA
Maximum demand I AVG	Md (Pd)	56-57	15C-15D	-	mA
Maximum demand I L1	Md (Pd)	58-59	15E-15F	-	mA
Maximum demand I L2	Md (Pd)	5A-5B	160-161	-	mA
Maximum demand I L3	Md (Pd)	5C-5D	162-163	-	mA
Maximum demand kvarL III	kvarL	200-201	204-205	-	kvarL
Maximum demand kvarC III	kvarC	202-203	206-207	-	kvarC

#### 4.10.3.2. Energy variables

All the addresses of Modbus memory are in Hexadecimal.

For these variables is implemented the **Function 0x03** and **0x04**.

**Table 20: Modbus memory map (Table 2)**

Parameter	Symbol	Tariff 1	Tariff 2	Tariff 3	Total	Units
Consumed active energy kW)	kWh III	5E-5F	88-89	B2-B3	DC-DD	kWh
Consumed active energy (W)	kWh III	60-61	8A-8B	B4-B5	DE-DF	Wh
Consumed inductive reactive energy (kvarhL)	kvarhL III	62-63	8C-8D	B6-B7	E0-E1	kvarh
Consumed inductive reactive energy (varhL)	kvarhL III	64-65	8E-8F	B8-B9	E2-E3	varh
Consumed capacitive reactive energy (kvarhC)	kvarhC III	66-67	90-91	BA-BB	E4-E5	kvarh
Consumed capacitive reactive energy (varhC)	kvarhC III	68-69	92-93	BC-BD	E6-E7	varh
Consumed apparent energy (kVAh)	kVAh III	6A-6B	94-95	BE-BF	E8-E9	kVAh
Consumed apparent energy (VAh)	kVAh III	6C-6D	96-97	C0-C1	EA-EB	VAh
Consumed CO <sub>2</sub> emissions	KgCO <sub>2</sub>	6E-6F	98-99	C2-C3	EC-ED	x10
Consumption cost	\$	70-71	9A-9B	C4-C5	EE-EF	x10
Generated active energy (kW)	kWh III	72-73	9C-9D	C6-C7	F0-F1	kWh
Generated active energy (W)	kWh III	74-75	9E-9F	C8-C9	F2-F3	Wh
Generated inductive reactive energy (kvarhL)	kvarhL III	76-77	A0-A1	CA-CB	F4-F5	kvarh
Generated inductive reactive energy (varhL)	kvarhL III	78-79	A2-A3	CC-CD	F6-F7	varh
Generated capacitive reactive energy (kvarhC)	kvarhC III	7A-7B	A4-A5	CE-CF	F8-F9	kvarh
Generated capacitive reactive energy (varhC)	kvarhC III	7C-7D	A6-A7	D0-D1	FA-FB	varh
Generated apparent energy (kVAh)	kVAh III	7E-7F	A8-A9	D2-D3	FC-FD	kVAh

Table 20 (Continuation) : Modbus memory map (Table 2)

Parameter	Symbol	Tariff 1	Tariff 2	Tariff 3	Total	Units
Generated apparent energy (VAh)	kVAh III	80-81	AA-AB	D4-D5	FE-EF	VAh
Generated CO <sub>2</sub> emissions	KgCO <sub>2</sub>	82-83	AC-AD	D6-D7	100-101	x10
Generation Cost	\$	84-85	AE-AF	D8-D9	102-103	x10
Hours per tariff	Hours	86-87	B0-B1	DA-DB	104-105	sec

#### 4.10.3.3. Voltage and current harmonics.

All the addresses of Modbus memory are in Hexadecimal.

For these variables is implemented the **Function 0x03** and **0x04**.

Table 21: Modbus memory map (Table 3).

Parameter	L1 Voltage	L2 Voltage	L3 Voltage	Units
Fundamental Harm.	A28-A29	A48-A49	A68-A69	V x 10
2nd Order harmonic	A2A	A4A	A6A	% x 10
3rd Order harmonic	A2B	A4B	A6B	% x 10
4th Order harmonic	A2C	A4C	A6C	% x 10
5th Order harmonic	A2D	A4D	A6D	% x 10
6th Order harmonic	A2E	A4E	A6E	% x 10
7th Order harmonic	A2F	A4F	A6F	% x 10
8th Order harmonic	A30	A50	A70	% x 10
9th Order harmonic	A31	A51	A71	% x 10
10th Order harmonic	A32	A52	A72	% x 10
11th Order harmonic	A33	A53	A73	% x 10
12th Order harmonic	A34	A54	A74	% x 10
13th Order harmonic	A35	A55	A75	% x 10
14th Order harmonic	A36	A56	A76	% x 10
15th Order harmonic	A37	A57	A77	% x 10
16th Order harmonic	A38	A58	A78	% x 10
17th Order harmonic	A39	A59	A79	% x 10
18th Order harmonic	A3A	A5A	A7A	% x 10
19th Order harmonic	A3B	A5B	A7B	% x 10
20th Order harmonic	A3C	A5C	A7C	% x 10
21st Order harmonic	A3D	A5D	A7D	% x 10
22nd Order harmonic	A3E	A5E	A7E	% x 10
23rd Order harmonic	A3F	A5F	A7F	% x 10
24th Order harmonic	A40	A60	A80	% x 10
25th Order harmonic	A41	A61	A81	% x 10
26th Order harmonic	A42	A62	A82	% x 10
27th Order harmonic	A43	A63	A83	% x 10
28th Order harmonic	A44	A64	A84	% x 10
29th Order harmonic	A45	A65	A85	% x 10
30th Order harmonic	A46	A66	A86	% x 10
31st Order harmonic	A47	A67	A87	% x 10

Table 22: Modbus memory map (Table 4).

Parameter	L1 Current	L2 Current	L3 Current	Units
Fundamental Harm.	A88-A89	AA8-AA9	AC8-AC9	mA x 10
2nd Order harmonic	A8A	AAA	AAC	% x 10
3rd Order harmonic	A8B	AAB	ACB	% x 10
4th Order harmonic	A8C	AAC	ADC	% x 10
5th Order harmonic	A8D	AAD	ACD	% x 10
6th Order harmonic	A8E	AAE	ACE	% x 10
7th Order harmonic	A8F	AAF	ACF	% x 10
8th Order harmonic	A90	AB0	AD0	% x 10
9th Order harmonic	A91	AB1	AD1	% x 10
10th Order harmonic	A92	AB2	AD2	% x 10
11th Order harmonic	A93	AB3	AD3	% x 10
12th Order harmonic	A94	AB4	AD4	% x 10
13th Order harmonic	A95	AB5	AD5	% x 10
14th Order harmonic	A96	AB6	AD6	% x 10
15th Order harmonic	A97	AB7	AD7	% x 10
16th Order harmonic	A98	AB8	AD8	% x 10
17th Order harmonic	A99	AB9	AD9	% x 10
18th Order harmonic	A9A	ABA	ADA	% x 10
19th Order harmonic	A9B	ABB	ADB	% x 10
20th Order harmonic	A9C	ABC	ADC	% x 10
21st Order harmonic	A9D	ABD	ADD	% x 10
22nd Order harmonic	A9E	ABE	ADE	% x 10
23rd Order harmonic	A9F	ABF	ADF	% x 10
24th Order harmonic	AA0	AC0	AE0	% x 10
25th Order harmonic	AA1	AC1	AE1	% x 10
26th Order harmonic	AA2	AC2	AE2	% x 10
27th Order harmonic	AA3	AC3	AE3	% x 10
28th Order harmonic	AA4	AC4	AE4	% x 10
29th Order harmonic	AA5	AC5	AE4	% x 10
30th Order harmonic	AA6	AC6	AE6	% x 10
31st Order harmonic	AA7	AC7	AE7	% x 10

#### 4.10.3.4. Deleting parameters.

All the Modbus map addresses are hexadecimal.

The **0x05 function** is implemented for these variables.

Table 23: Modbus memory map: Deleting parameters.

Parameters	Address	Valid data margin
Deleting energies	834	<b>FF00</b>
Deleting maximum and minimum values	838	<b>FF00</b>
Starting maximum demand	839	<b>FF00</b>
Deleting the hour counters (All tariffs)	83D	<b>FF00</b>
Deleting the maximum value of the maximum demand	83F	<b>FF00</b>
Deleting energies, maximum demand and maximum and minimum values	848	<b>FF00</b>

#### 4.10.3.5. Power status.

All the Modbus map addresses are hexadecimal.

The **0x04 function** is implemented for this variable.

This variable indicates the quadrant in which the device is operating.

Table 24:Modbus memory map: Power status

Power status		
Variable	Address	Default value
Power status	7D1	-

The variable format is shown in Table 25:

Table 25:Variable format: Power status.

Bit 7	Bit 6	Bit 5	Bit 4	Bit 3	Bit 2	Bit 1	Bit 0
0	0	0	0	1: Capacitive	1: Inductive	1: Generated	1: Consumed

#### 4.10.3.6. The unit's serial number.

All the Modbus map addresses are hexadecimal.

The **0x04 function** is implemented for this variable.

Table 26:Modbus memory map: Serial number.

The unit's serial number		
Variable	Address	Default value
Serial number	578 - 579	-

#### 4.10.3.7. Detection of incorrect direction of rotation (Version 4.05 or higher)

All the Modbus map addresses are hexadecimal.

The **0x04 function** is implemented for this variable.

This variable indicates whether an incorrect direction of rotation has been detected in the voltages.

Table 27:Modbus memory map : Detection of incorrect direction of rotation.

Detection of incorrect direction of rotation		
Variable	Address	Value
Detection of incorrect direction of rotation	7D5	0: No fault has been detected 1: Fault detected

#### 4.10.3.8. Device configuration variables.

All the Modbus map addresses are hexadecimal.

The **0x04** and **0x10 functions** are implemented for this variable.

The device's Modbus function does not check whether the variables recorded are within the correct margins, they are only checked when they are read from the EEPROM. So if any parameter is recorded with an incorrect value the device will be configured with its default value.

The Modbus configuration will not take effect until the device is reset.



#### 4.10.3.8.1. Transformation ratios.

Table 28: Modbus memory map: Transformation ratios.

Transformation ratios			
Configuration variable <sup>(3) (4)</sup>	Address	Valid data margin	Default value
Voltage primary	2710 - 2711	1 - 599999	1
Voltage secondary	2712	1 - 999	1
Current primary	2713	1 - 10000	5
Current secondary	2714	1: .../1A 5: ../5 A	5

<sup>(3)</sup> All variables must be programmed at the same time.

<sup>(4)</sup> Voltage ratio x Current ratio < 600000.

**Note:** The ratio is between the primary and the secondary.

#### 4.10.3.8.2. Neutral current transformation ratios (CVM-C10-ITF-IN and CVM-C10-MC-IN).

Table 29: Modbus memory map: Neutral current transformation ratios.

Transformation ratios			
Configuration variable <sup>(5)</sup>	Address	Valid data margin	Default value
Neutral current primary	271A	1 - 10000	5
Neutral current secondary <sup>(6)</sup>	271B	1: .../1A 5: ../5 A	5

<sup>(5)</sup> All variables must be programmed at the same time.

<sup>(6)</sup> This variable is only programmed for the **CVM-C10-ITF-IN** model.

#### 4.10.3.8.3. Number of quadrants

Table 30: Modbus memory map: Number of quadrants

Maximum demand			
Configuration variable	Address	Valid data margin	Default value
Number of quadrants	2B64	0: 4 quadrants 1: 2 quadrants	0

#### 4.10.3.8.4. Measurement convention

Table 31: Modbus memory map: Measurement convention.

Measurement convention			
Configuration variable	Address	Valid data margin	Default value
Measurement convention	2B86	0: Circutor 1: IEC 2: IEEE	0



#### 4.10.3.8.5. Type of installation

Table 32: Modbus memory map: Type of installation

Type of installation			
Configuration variable	Address	Valid data margin	Default value
Type of installation	2B5C	<b>0:</b> 4 - 3Ph Three-phase network with 4 wires. <b>1:</b> 3 - 3Ph Three-phase network with 3 wires. <b>2:</b> 3 - ArOn Three-phase network with 3 wires, Aron. <b>3:</b> 3 - 2Ph Two-phase network with 3 wires. <b>4:</b> 2 - 2Ph Single-phase network with 2 wires, phase-to-phase. <b>5:</b> 2 - 1Ph Single-phase network with 2 wires, phase-to-neutral.	0

#### 4.10.3.8.6. Maximum demand

Table 33: Modbus memory map: Maximum demand

Maximum demand			
Configuration variable	Address	Valid data margin	Default value
Integration period	274C	1 - 60 minutes	15

#### 4.10.3.8.7. Operating profile

Table 34: Modbus memory map: Operating profile

Operating profile			
Configuration variable	Address	Valid data margin	Default value
Operating profile	2B60	<b>0:</b> Analyzer <b>1:</b> User <b>2:</b> Electrical energy efficiency, e <sup>3</sup>	0

#### 4.10.3.8.8. Display backlight

Table 35: Modbus memory map: Backlight

Backlight			
Configuration variable	Address	Valid data margin	Default value
Backlight	2B5E	<b>0:</b> Always lit <b>5 - 99</b> seconds	0

#### 4.10.3.8.9. Activating the harmonics display screen

Table 36: Modbus memory map: Display of harmonics

Display of harmonics			
Configuration variable	Address	Valid data margin	Default value
Display of harmonics	2B62	<b>0:</b> No <b>1:</b> Yes	1

#### 4.10.3.8.10. CO<sub>2</sub> consumption and generation emissions.

 Table 37: Modbus memory map: CO<sub>2</sub> consumption and generation emissions.

CO <sub>2</sub> emissions			
Configuration variable <sup>(7)(8)</sup>	Address	Valid data margin	Default value
Tariff 1 consumption emissions ratio	2724	0 - 1.9999	0
Tariff 2 consumption emissions ratio	2725	0 - 1.9999	0
Tariff 3 consumption emissions ratio	2726	0 - 1.9999	0
Tariff 1 generation emissions ratio	2728	0 - 1.9999	0
Tariff 2 generation emissions ratio	2729	0 - 1.9999	0
Tariff 3 generation emissions ratio	272A	0 - 1.9999	0

<sup>(7)</sup> All variables must be programmed at the same time.

<sup>(8)</sup> They have 1 decimal place.

#### 4.10.3.8.11. Cost of energy consumption and generation.

Table 38: Modbus memory map: Cost of energy consumption and generation.

Cost per kWh			
Configuration variable <sup>(9)(10)</sup>	Address	Valid data margin	Default value
Cost per kWh of tariff 1 consumption	272C	0 - 1.9999	0
Cost per kWh of tariff 2 consumption	272D	0 - 1.9999	0
Cost per kWh of tariff 3 consumption	272E	0 - 1.9999	0
Cost per kWh of tariff 1 generation	2730	0 - 1.9999	0
Cost per kWh of tariff 2 generation	2731	0 - 1.9999	0
Cost per kWh of tariff 3 generation	2732	0 - 1.9999	0

<sup>(9)</sup> All variables must be programmed at the same time.

<sup>(10)</sup> They have 1 decimal place.

#### 4.10.3.8.12. Programming alarms 1 and 2 (Relays 1 and 2)

**Note :** Configuration parameters not available for the **CVM-C10-FLEX** model.

Table 39: Modbus memory map: Programming alarms 1 and 2.

Programming alarms 1 and 2				
Configuration variable	Address		Valid data margin	Default value
	Relay 1	Relay 2		
Maximum value.	2AF8-2AF9	2B02-2B03	depending on the variable	0
Minimum value	2AFA-2AFB	2B04-2B05	depending on the variable	0
Variable code	2AFC	2B06	<b>Table 15</b>	0
Connection delay	2AFD	2B07	<b>0 - 9999</b> seconds	0
Hysteresis:	2AFE	2B08	<b>0 - 99</b> %	0
latch	2AFF	2B09	<b>0</b> : No <b>1</b> : Yes	0
Disconnection delay	2B00	2B0A	<b>0 - 9999</b> seconds	0
Contacts status	2B01	2B0B	<b>0</b> : Normally open <b>1</b> : Normally closed	0

#### 4.10.3.8.13. Programming alarms 3 and 4 (Digital outputs T1 and T2)

**Note :** Configuration parameters not available for the **CVM-C10-FLEX** , **CVM-C10-ITF-IN** and **CVM-C10-MC-IN** models.

Table 40:Modbus memory map: Programming alarms 3 and 4.

Programming alarms 3 and 4				
Configuration variable	Address		Valid data margin	Default value
	Relay 1	Relay 2		
Kilowatts per impulse	2B0C-2B0D	2B16-2B17	0.001 - 999.999 kWh	0
Variable code	2B10	2B1A	<b>Table 18</b>	0
Pulse width	2B11	2B1B	<b>10 - 500 ms</b>	100 ms

#### 4.10.3.8.14. Digital inputs

Table 41:Modbus memory map: Configuration of digital inputs.

Configuration variable	Address		Valid data margin	Default value
	Input 1	Input 2		
Operating mode <sup>(11)</sup>	2B66	2B67	<b>0:</b> Tariff <b>1:</b> Logic state	0

<sup>(11)</sup> If Input 1 is configured as a tariff and Input 2 is configured as a logic state (or vice versa) we will only have 2 tariffs.

We can also read the status of the digital inputs when they are in logic mode:

The **0x04 function** is implemented for this variable.

Table 42:Modbus memory map: Status of the digital inputs (Logic state mode)

Status of digital inputs		
Variable	Address	Default value
Status of digital inputs	4E20	-

The variable format is shown in **Table 43**:

Table 43:Variable format: Status of digital inputs.

Bit 7	Bit 6	Bit 5	Bit 4	Bit 3	Bit 2	Bit 1	Bit 0
0	0	0	0	0	0	<b>Input 2</b> <b>0:</b> OFF <b>1:</b> ON	<b>Input 1</b> <b>0:</b> OFF <b>1:</b> ON

#### 4.10.3.8.15. Digital outputs

Reading the status of the digital outputs.

The **0x04 function** is implemented for this variable.

Table 44:Modbus memory map: Status of the digital outputs

Status of the digital outputs		
Variable	Address	Default value
Status of the digital outputs	4E21	-

The variable format is shown in **Table 45**:

Table 45: Variable format: Status of the digital outputs.

Bit 7	Bit 6	Bit 5	Bit 4	Bit 3	Bit 2	Bit 1	Bit 0
0	0	0	0	Output 4 0: OFF 1: ON	Output 3 0: OFF 1: ON	Output 2 0: OFF 1: ON	Output 1 0: OFF 1: ON

#### 4.10.3.8.16. Communications

Table 46: Modbus memory map: Communications

Communications			
Configuration variable	Address	Valid data margin	Default value
Protocol	2742	0 : Modbus 1: Bacnet	0
<b>Modbus and BACnet:</b> Peripheral number	2743	<b>0 - 255</b>	1
<b>Modbus :</b> Transmission speed	2744	<b>0:</b> 9600 - <b>1:</b> 19200	0
<b>Modbus :</b> Parity	2745	<b>0:</b> No parity <b>1:</b> Odd parity <b>2:</b> Even parity	0
<b>Modbus :</b> Data bits	2746	<b>0 :</b> 8 bits <b>1:</b> 7 bits	0
<b>Modbus :</b> Stop bits	2747	<b>0 :</b> 1 stop bit <b>1:</b> 2 stop bits	0
<b>BACnet:</b> Device ID	2EE0- 2EE1	<b>0- 999999</b>	-
<b>BACnet:</b> MAC	2EE2	<b>0- 255</b>	2

#### 4.10.3.8.17. Password configuration

These variables allow you to lock or unlock access to the programming menu, and also allow you to change the password code. The password code may only be changed through this command.

The device does not need you to enter the old password in order for it to record the new one; it records the new one directly without any verification.

Table 47: Modbus memory map: Password configuration

Password			
Configuration variable <sup>(12)</sup>	Address	Valid data margin	Default value
Password value <sup>(13)</sup>	2B70	<b>0 - 9999</b>	1234
Lock-Unlock	2B71	<b>0:</b> Unlock <b>1:</b> Lock	0

<sup>(12)</sup> You must program all the variables at the same time.

<sup>(13)</sup> The password value is read and written in hexadecimal.

#### 4.10.4. BACnet PROTOCOL

**BACnet** is a communications protocol for Building Automation and Control NETWORKS. This protocol replaces the proprietary communications of each device, making it a set of common communication rules that enables the complete integration of the building automation and control devices of different manufacturers.

The device features **BACNet** MS/TP communications, following the specifications of ANSI/ASHRAE 135 (ISO 16484-5).

Using a RS485 connection, the device can connect to a BACnet and include all of the objects and services defined in the attached PICS map (Protocol Implementation Conformance Statement). ( "**4.10.5. PICS MAP**")

The default speed is 9600 bps and the MAC is 2 (node number), and can be changed on the configuration screen or by entering the BaudRate and MAC\_Address variables. The identifier (Device\_ID) can be changed on the configuration screen using the writing property over the variable or through the Device\_ID variable.

Another option is to overwrite the Object\_Name in the Device object:

- a) #Baud x – where x can be: 9600, 19200
- b) #MAC x – where x can be: 0 ... 127
- c) #ID x – where x can be: 0 ... 999999

For further information on the protocol: [www.bacnet.org](http://www.bacnet.org).

### 4.10.5. MAPA PICS

**PICS**

**Vendor Name:** CIRCUTOR  
**Product Name:** CVM-C10  
**Product Model Number:** 0116  
**Application Software Version:** 1.0  
**Firmware Revision:** 0.7.1  
**BACnet Protocol Revision:** 10

**Product Description:**

Electrical energy meter

**BACnet Standardized Device Profile (Annex L)**

x	BACnet Application Specific Controller (B-ASC)
---	--

**List all BACnet Interoperability Building supported (see Annex K in BACnet Addendum 135d):**

DS-RP-B Read Property  
 DS-WP-B Write Property  
 DS-RPM-B Read Property Multiple  
 DM-DDB-B Dynamic Device Binding  
 DM-DOB-B Dynamic Object Binding  
 DM-DCC-B Device Communication Control  
 DM-RD-B Reinitialize Device

**Which of the following device binding methods does the product support? (check one or more)**

x	Recive Who-Is, send I-Am (BIBB DM-DDB-B)
x	Recive Who-Has, send I-Have (BIBB DM-DOB-B)

**Standard Object Types Supported:**

**Analog Input Object Type**

1. Dynamically creatable using BACnet's CreateObject service?	No	
2. Dynamically deleatable using BACnet's DeleteObject service?	No	
3. List of optional properties supported:	max_pres_value	min_pres_value
4. List of all properties that are writable where not otherw is a required by this standard		
5. List of proprietary properties:		
6. List of any property value range restrictions:		

**Property Identifier**

Object_Name	max 32 characters
-------------	-------------------

DESCRIPTION		SYMBOL	ID OBJECTS	OBJECT NAME	UNITS
Tensión fase-neutro	Voltage phase to neutral	V 1	AI0	Ph2NU1	V
Corriente	Current	A 1	AI1	Ph1Current	A
Potencia activa	Active power	kW 1	AI2	ActPwrPh1	kW
Potencia reactiva	Reactive power	kvar 1	AI3	ReactPwrPh1	kvar
Factor de potencia	Power factor	PF 1	AI4	PwrFactPh1	PF
Tensión fase-neutro	Voltage phase to neutral	V 2	AI5	Ph2NU2	V
Corriente	Current	A 2	AI6	Ph2Current	A
Potencia activa	Active power	kW 2	AI7	ActPwrPh2	kW

DESCRIPTION		SYMBOL	ID OBJECTS	OBJECT NAME	UNITS
Potencia reactiva	Reactive power	kvar 2	AI8	ReactPwrPh2	kvar
Factor de potencia	Power factor	PF 2	AI9	PwrFactPh2	PF
Tensión fase-neutro	Voltage phase to neutral	V 3	AI10	Ph2NU3	V
Corriente	Current	A 3	AI11	Ph3Current	A
Potencia activa	Active power	kW 3	AI12	ActPwrPh3	kW
Potencia reactiva	Reactive power	kvar 3	AI13	ReactPwrPh3	kvar
Factor de potencia	Power factor	PF 3	AI14	PwrFactPh3	PF
Potencia activa trifásica	Three phase active power	kW III	AI15	ActPwOn3Ph	kW
Potencia inductiva trifásica	Three phase reactive inductive power	kvarL III	AI16	InductPwOn3Ph	kvarL
Potencia capacitiva trifásica	Three phase capacitive inductive power	kvarC III	AI17	CapPwOn3Ph	kvarC
Cos $\varphi$ trifásico	Three phase cos $\varphi$	Cos $\varphi$ III	AI18	Cosphi	Cos $\varphi$
Factor de potencia trifásico	Three phase power factor	PFIII	AI19	PwFactOn3Ph	PF
Frecuencia (L2)	Frequency	Hz	AI20	Frequency	Hz
Tensión fase-fase	Voltage phase to phase	V12	AI21	Ph2PhU12	V
Tensión fase-fase	Voltage phase to phase	V23	AI22	Ph2PhU23	V
Tensión fase-fase	Voltage phase to phase	V31	AI23	Ph2PhU31	V
%THD V	%THD V	%THD V1	AI24	THDVal_U1	%THD
%THD V	%THD V	%THD V2	AI25	THDVal_U2	%THD
%THD V	%THD V	%THD V3	AI26	THDVal_U3	%THD
%THD A	%THD A	%THD A1	AI27	THDVal_I1	%THD
%THD A	%THD A	%THD A2	AI28	THDVal_I2	%THD
%THD A	%THD A	%THD A3	AI29	THDVal_I3	%THD
Energía activa	Active energy	kW·h III	AI30	ActEnergy	kW·h
Energía reactiva inductiva	Reactive inductive energy	kvarL·h III	AI31	InductEnergy	kvarL·h
Energía reactiva capacitiva	Reactive capacitive energy	kvarC·h III	AI32	CapEnergy	kvarC·h
Energía Aparente trifásica	Three phase aparent energy	kVA·h III	AI33	AppEnergy	kVA·h
Energía activa generada	Three phase generated active energy	kW·h III (-)	AI34	ActEnergy_exp	kW·h
Energía inductiva generada	Three phase generated reactive inductive energy	kvarL·h III (-)	AI35	IndEnergy_exp	kvarL·h
Energía capacitiva generada	Three phase generated reactive capacitive energy	kvarC·h III(-)	AI36	CapEnergy_exp	kvarC·h
Energía aparente generada	Three phase generated aparent energy	kVA·h III (-)	AI37	AppEnergy_exp	kVA·h
Corriente trifásica (media)	Three phase average current	I_AVG	AI38	AvgValCurr3Ph	I_AVG
Corriente de neutro	Neutral current	In	AI39	NeutralCurrent	In
Potencia aparente L1	Aparent power L1	kVA	AI40	AppPwrPh1	kVA
Potencia aparente L2	Aparent power L2	kVA	AI41	AppPwrPh2	kVA
Potencia aparente L3	Aparent power L3	kVA	AI42	AppPwrPh3	kVA

DESCRIPTION		SYMBOL	ID OBJECTS	OBJECT NAME	UNITS
Potencia aparente trifásica	Three phase aparent power	kVAIII	AI43	AppPw3Ph	kVA
Máxima demanda I1	Maximum demand I1	Md (A1)	AI44	MaxDemand_A1	A
Máxima demanda I2	Maximum demand I2	Md(A2)	AI45	MaxDemand_A2	A
Máxima demanda I3	Maximum demand I3	Md(A3)	AI46	MaxDemand_A3	A
Máxima demanda A	Maximum demand A	A III	AI47	MaxDemand_A	A
Máxima demanda kW	Maximum demand kW	kW III	AI48	MaxDemand_kW	kW
Máxima demanda kVA	Maximum demand kVA	kVA III	AI49	MaxDemand_kVA	kVA

### Analog Value Object Type

1. Dynamically creatable using BACnet's CreateObject service?		No
2. Dynamically deletable using BACnet's DeleteObject service?		No
3. List of optional properties supported:		
4. List of all properties that are writable where not otherwise required by this standard		
5. List of proprietary properties:		
Property Identifier	Property Datatype	Meaning
5. List of object identifiers and their meaning in this device		
Object ID	Object Name	Description
AV1	MAC_Address	MAC
AV2	BaudRate	BAUD RATE
AV3	Device_ID	DEVICE ID

### Device Object Type

1. Dynamically creatable using BACnet's CreateObject service?		No
2. Dynamically deletable using BACnet's DeleteObject service?		No
3. List of optional properties supported:		Description, Protocolo_Conformance_Class
4. List of all properties that are writable where not otherwise required by this standard		
Object_Name Max_Master Max_Info_Frames Object_Identifier		
5. List of proprietary properties:		
5. List of any property value range restrictions		
Property Identifier	Restrictions	
Object_Name	< 32 bytes	
Object_Identifier	Device Type only	
Number_Of_APDU_Retries	0-255	
APDU_Timeout	0-65535 miliseconds	
Vendor_Identifier	0-65535	

### Data Link Layer Options (check all that supported):

X	MS/TP master (Clause 9), baud rate(s): 9.6, 19.2kB/s
---	--

### Character Sets Supported (check all that apply):

Indicating support for multiple character set does not imply that they can all be supported simultaneously.

X	ANSI X3.4
---	-----------



## 5.- TECHNICAL FEATURES

AC Power supply	
Rated voltage	95 ... 240 V ~ ± 10%
Frequency	50 ... 60 Hz
Consumption	4 ... 6 VA
Installation category	CAT III 300 V

DC Power supply		
Rated voltage	105 ... 272 V == ± 10%	23 ... 109 V == ± 10% <sup>(14)</sup>
Consumption	2 ... 6 W	3.5 ... 3 W
Installation category	CAT III 300 V	

<sup>(14)</sup> Only available for references M5591100F0000, M5592100F0000, M5592100F0V00, M5594200F00000 and M5596100F0000.

Voltage measurement circuit	
Rated voltage (Un)	300 V Ph-N, 520 V Ph-Ph
Voltage measurement margin	5 ... 120% Un
Frequency measurement margin	45 ... 65Hz
Input impedance	440 kΩ
Min. voltage measurement (Vstart)	15 V
Installation category	CAT III 300 V

Current measurement circuit		
<b>CVM-C10-FLEX</b>	Measure through Rogowski sensors.	
<b>Nominal current (In)</b>	<b>CVM-C10-ITF CVM-C10-ITF-IN</b>	<b>CVM-C10-MC CVM-C10-MC-IN</b>
	.../5A o .../1 A	.../0.250 A
<b>Neutral current measurement</b>	<b>CVM-C10-mV</b>	<b>CVM-C10-FLEX</b>
	.../0.333 V	.../100 mV ~
<b>Current measurement margin</b>	<b>CVM-C10-ITF-IN</b>	<b>CVM-C10-FLEX</b>
	.../5A o .../1 A	.../100 mV ~
	<b>CVM-C10-MC-IN</b>	
<b>Maximum current, impulse &lt; 1s</b>	.../0.250 A	
	<b>CVM-C10-ITF CVM-C10-ITF-IN</b>	<b>CVM-C10-MC CVM-C10-MC-IN</b>
	2 ... 120% In	≥ 10 ... ≤ 100% In
	<b>CVM-C10-mV</b>	<b>CVM-C10-FLEX</b>
<b>Min. current measurement (Istart)</b>	2 ... 120% In	0.2 ... 200% In
	<b>CVM-C10-ITF CVM-C10-ITF-IN</b>	<b>CVM-C10-MC CVM-C10-MC-IN</b>
	100 A	100 A
<b>Min. current measurement (Istart)</b>	<b>CVM-C10-mV</b>	<b>CVM-C10-FLEX</b>
	1.2 In	2 In
	<b>CVM-C10-ITF CVM-C10-ITF-IN</b>	<b>CVM-C10-MC CVM-C10-MC-IN</b>
<b>Min. current measurement (Istart)</b>	10 mA	0.2 % In
	<b>CVM-C10-mV</b>	<b>CVM-C10-FLEX</b>
	6.66 mV	0.2 mV ~

<b>(Continuation) Current measurement circuit</b>		
<b>Consumption</b>	<b>CVM-C10-ITF CVM-C10-ITF-IN</b>	<b>CVM-C10-MC CVM-C10-MC-IN</b>
	0.9 VA	0.18 VA
	<b>CVM-C10-mV</b>	<b>CVM-C10-FLEX</b>
	0.033 mVA	0.004 VA
<b>Installation category</b>	CAT III 300 V	

<b>Measurement accuracy</b>			
<b>Model</b>	<b>CVM-C10-ITF CVM-C10-ITF-IN</b>	<b>CVM-C10-MC <sup>(17)</sup> CVM-C10-MC-IN <sup>(17)</sup></b>	<b>CVM-C10-mV</b>
<b>Voltage measurement</b>	0.5% ± 1 digit	0.5% ± 1 digit	0.5% ± 1 digit
<b>Current measurement</b>	0.5% ± 1 digit	0.5% ± 1 digit	0.5% ± 1 digit
<b>Frequency measurement</b>	0.5%	0.5%	0.5%
<b>Active power measurement</b>	0.5% ± 2 digits	1% ± 2 digits	0.5% ± 2 digits
<b>Reactive power measurement</b>	1% ± 2 digits	2% ± 2 digits	2% ± 2 digits
<b>Active energy measurement</b>	Class 0.5s <sup>(15)</sup> (I ≥ 0.1In)	Class 1	Class 1
<b>Reactive energy measurement</b>	Class 1 <sup>(16)</sup> (I ≥ 0.1In)	Class 2	Class 2

<sup>(15)</sup> According to IEC 62053-22.

<sup>(16)</sup> According to IEC 62053-24.

<sup>(17)</sup> Measurement range:

	<b>PF:1</b>	<b>PF:0.5</b>
<b>Measurement range</b>	≥ 10% ... ≤ 100%	≥ 20% ... ≤ 100%

<b>Measurement accuracy (With sensors)</b>	
<b>Model</b>	<b>CVM-C10-FLEX <sup>(18)</sup></b>
<b>Voltage measurement</b>	± 0.5% + 1 decimal
<b>Current measurement</b>	± 3%
<b>Frequency measurement</b>	± 0.5%
<b>Active power measurement</b>	± 4%
<b>Reactive power measurement</b>	± 4%

<sup>(18)</sup> See section "3.3.- CVM-C10-FLEX: ROGOWSKI SENSORS"

<b>Pulse outputs (CVM-C10-ITF CVM-C10-MC and CVM-C10-mV) <sup>(19)</sup></b>	
<b>Quantity</b>	2
<b>Type</b>	NPN outputs
<b>Maximum voltage</b>	24 V ---
<b>Maximum current</b>	50 mA
<b>Maximum frequency</b>	16 impulses / sec
<b>Pulse width</b>	30 ms to 500 ms (Programmable)

<b>Relay outputs (CVM-C10-ITF, CVM-C10-ITF-IN, CVM-C10-MC, CVM-C10-MC-IN, CVM-C10-mV) <sup>(19)</sup></b>	
<b>Quantity</b>	2
<b>Max. voltage open contacts</b>	250 V ~
<b>Maximum current</b>	6 A
<b>Maximum switching power</b>	1500 W (AC1)
<b>Electrical life (250 VAC / 5A)</b>	60x10 <sup>3</sup> cycles
<b>Mechanical life</b>	10x10 <sup>6</sup> cycles

Digital inputs <sup>(19)</sup>	
Quantity	2
Type	NPN Potential free contact
Insulation	optoisolated

<sup>(19)</sup> Must be connected to SELV circuit.

Communications		
	Modbus RTU	BACnet
Bus	RS-485	MS/TP
Protocol	Modbus RTU	BACnet
Baud rate	9600 - 19200	
Stop bits	1 - 2	1
Parity	without - even - odd	without

User interface	
Display	LCD Custom COG
Keyboard	Capacitive, 3 keys
LED	3 LED

Environmental features	
Operating temperature	-5°C... +45°C
Storage temperature	-10°C ... +50°C
Relative humidity (non-condensing)	5 ... 95%
Maximum altitude	2000 m
Protection degree <sup>(20)</sup>	IP21 Front panel: IP51 (IP64 with accessory)

<sup>(20)</sup> This pollution degree hasn't been tested by UL.

Mechanical features	
Dimensions ( Figure 35)	96.7x96.7x62.5 mm
Weight	330 gr
Surround	Self-extinguishing V0 plastic
Attachment	Panel

Standards	
Safety of electronic measuring units	UNE EN 61010: 2010
Electromagnetic compatibility (CEM). Part 6-3: Generic standards. Emission standard for residential, commercial and light industry environments.	UNE EN 61000-6-3:2007
Electromagnetic compatibility (CEM). Part 6-1: Generic standards. Immunity in residential, commercial and light industry environments	UNE EN 61000-6-1:2007
Coordination of the insulation of units installed in low voltage systems (networks).	IEC 664:2007
	VDE 0110
Test for flammability of plastic materials for parts in devices and appliances	UL 94
Electromagnetic compatibility (EMC). Generic standards. Immunity for industrial environments	BS EN 61000-6-2
Electromagnetic compatibility (EMC). Generic standards. Emission standard for industrial environments	BS EN 61000-6-4
Safety requirements for electrical equipment for measurement, control, and laboratory use - Part 1: General requirements	UL/CSA 61010-1 3rd edition

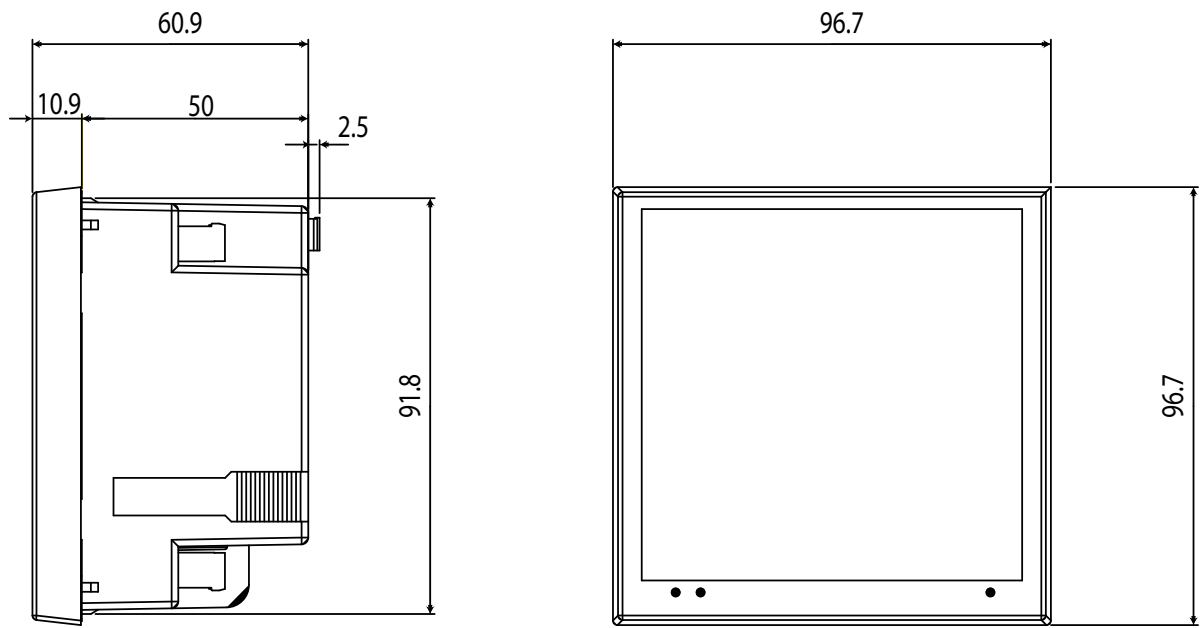

Figure 35: Dimensions of the CVM-C10.

## 6.- MAINTENANCE AND TECHNICAL SERVICE

In the case of any query in relation to unit operation or malfunction, please contact the **CIRCUTOR, SA** Technical Support Service.

### Technical Assistance Service

Vial Sant Jordi, s/n, 08232 - Viladecavalls (Barcelona)

Tel: 902 449 459 ( España ) / +34 937 452 919 (outside of Spain)

email: sat@circutor.es

## 7.- GUARANTEE

**CIRCUTOR** guarantees its products against any manufacturing defect for two years after the delivery of the units.

**CIRCUTOR** will repair or replace any defective factory product returned during the guarantee period.



- No returns will be accepted and no unit will be repaired or replaced if it is not accompanied by a report indicating the defect detected or the reason for the return.
- The guarantee will be void if the units has been improperly used or the storage, installation and maintenance instructions listed in this manual have not been followed. "Improper usage" is defined as any operating or storage condition contrary to the national electrical code or that surpasses the limits indicated in the technical and environmental features of this manual.
- **CIRCUTOR** accepts no liability due to the possible damage to the unit or other parts of the installation, nor will it cover any possible sanctions derived from a possible failure, improper installation or "improper usage" of the unit. Consequently, this guarantee does not apply to failures occurring in the following cases:
  - Overvoltages and/or electrical disturbances in the supply;
  - Water, if the product does not have the appropriate IP classification;
  - Poor ventilation and/or excessive temperatures;
  - Improper installation and/or lack of maintenance;
  - Buyer repairs or modifications without the manufacturer's authorisation.

## 8.- CE CERTIFICATE



### DECLARACIÓN UE DE CONFORMIDAD

La presente declaración de conformidad se expide bajo la exclusiva responsabilidad de CIRCUTOR con dirección en Vial Sant Jordi, s/n – 08232 Viladecavalls (Barcelona) España

Producto:

**Analizadores de redes panel 96 x96**

Serie:

**CVM-C10**

Marca:

**CIRCUTOR**

EL objeto de la declaración es conforme con la legislación de armonización pertinente en la UE, siempre que sea instalado, mantenido y usado en la aplicación para la que ha sido fabricado, de acuerdo con las normas de instalación aplicables y las instrucciones del fabricante

2014/35/UE: Low Voltage Directive 2014/30/UE: Electromagnetic Compatibility Directive

2011/65/UE: RoHS2 Directive

Está en conformidad con la(s) siguiente(s) norma(s) u otro(s) documento(s) normativos(s):

IEC 61010-1:2010-AMD1:2016 CSV Ed 3.0 IEC 61326-1:2012 Ed 2.0  
IEC 61000-6-2:2016 Ed 3.0 IEC 61000-6-4:2006-AMD1:2010 CSV Ed 2.1  
UL 61010-1, 3rd Edition, 2012-5

Año de marcado "CE":

2014



### EU DECLARATION OF CONFORMITY

This declaration of conformity is issued under the sole responsibility of CIRCUTOR with registered address at Vial Sant Jordi, s/n – 08232 Viladecavalls (Barcelona) Spain

Product:

**Power analyzer mounting panel 96 x96**

Series:

**CVM-C10**

Brand:

**CIRCUTOR**

The object of the declaration is in conformity with the relevant EU harmonisation legislation, provided that it is installed, maintained and used for the application for which it was manufactured, in accordance with the applicable installation standards and the manufacturer's instructions

2014/35/UE: Low Voltage Directive 2014/30/UE: Electromagnetic Compatibility Directive

2011/65/UE: RoHS2 Directive

It is in conformity with the following standard(s) or other regulatory document(s):

IEC 61010-1:2010-AMD1:2016 CSV Ed 3.0 IEC 61326-1:2012 Ed 2.0  
IEC 61000-6-2:2016 Ed 3.0 IEC 61000-6-4:2006-AMD1:2010 CSV Ed 2.1  
UL 61010-1, 3rd Edition, 2012-5

Year of CE mark:

2014



### DÉCLARATION UE DE CONFORMITÉ

La présente déclaration de conformité est délivrée sous la responsabilité exclusive de CIRCUTOR dont l'adresse postale est Vial Sant Jordi, s/n – 08232 Viladecavalls (Barcelona) Espagne

Produit:

**analyseurs de réseaux triphasés panneau 96x96**

Série:

**CVM-C10**

Marque:

**CIRCUTOR**

L'objet de la déclaration est conforme à la législation d'harmonisation pertinente dans l'UE, à condition d'avoir été installé, entretenu et utilisé dans l'application pour laquelle il a été fabriqué, conformément aux normes d'installation applicables et aux instructions du fabricant

2014/35/UE: Low Voltage Directive 2014/30/UE: Electromagnetic Compatibility Directive

2011/65/UE: RoHS2 Directive

Il est en conformité avec la(les) suivante(s) norme(s) ou autre(s) document(s) réglementaire(s):

IEC 61010-1:2010-AMD1:2016 CSV Ed 3.0 IEC 61326-1:2012 Ed 2.0  
IEC 61000-6-2:2016 Ed 3.0 IEC 61000-6-4:2006-AMD1:2010 CSV Ed 2.1  
UL 61010-1, 3rd Edition, 2012-5

Année de marquage « CE »:

2014



Viladecavalls (Spain), 19/07/2017  
General Manager: Ferran Gil Torné

**KONFORMITÄTSERKLÄRUNG UE**

Vorliegende Konformitätserklärung wird unter alleiniger Verantwortung von CIRCUTOR mit der Anschrift, Vial Sant Jordi, s/n – 08232 Viladecavalls (Barcelona) Spanien, ausgestellt

Produkt:

**Dreiphasen-Leistungsanalyser Schaltfrei 96 x96**

Serie:

**CVM-C10**

Marke:

**CIRCUTOR**

Der Gegenstand der Konformitätserklärung ist konform mit der geltenden Gesetzgebung zur Harmonisierung der EU, sofern die Installation, Wartung und Verwendung der Anwendung seinem Verwendungszweck entsprechend gemäß den geltenden Installationsstandards und der Vorgaben des Herstellers erfolgt.

2014/35/UE: Low Voltage Directive 2014/30/UE: Electromagnetic Compatibility Directive

2011/65/UE: RoHS2 Directive

Es besteht Konformität mit der/den folgender/folgenden Norm/Normen oder sonstigem/Sonstiger Regelwerk/Regelwerken

IEC 61010-1:2010-AMD1:2016 CSV Ed 3.0 IEC 61326-1:2012 Ed 2.0  
IEC 61000-6-2:2016 Ed 3.0 IEC 61000-6-4:2006-AMD1:2010 CSV Ed 2.1  
UL 61010-1, 3rd Edition, 2012-5

Jahr der CE-Kennzeichnung: 2014

**DECLARAÇÃO DA UE DE CONFORMIDADE**

A presente declaração de conformidade é expedida sob a exclusiva responsabilidade da CIRCUTOR com morada em Vial Sant Jordi, s/n – 08232 Viladecavalls (Barcelona) Espanha

Produto:

**Analisadores de redes: painel 96 x96**

Série:

**CVM-C10**

Marca:

**CIRCUTOR**

O objeto da declaração está conforme a legislação de harmonização pertinente na UE, sempre que seja instalado, mantido e utilizado na aplicação para a qual foi fabricado, de acordo com as normas de instalação aplicáveis e as instruções do fabricante.

2014/35/UE: Low Voltage Directive 2014/30/UE: Electromagnetic Compatibility Directive

2011/65/UE: RoHS2 Directive

Está em conformidade com a(s) seguinte(s) norma(s) ou outro(s) documento(s) normativo(s):

IEC 61010-1:2010-AMD1:2016 CSV Ed 3.0 IEC 61326-1:2012 Ed 2.0  
IEC 61000-6-2:2016 Ed 3.0 IEC 61000-6-4:2006-AMD1:2010 CSV Ed 2.1  
UL 61010-1, 3rd Edition, 2012-5

Ano de marcação "CE": 2014

**DICHIARAZIONE DI CONFORMITÀ UE**

La presente dichiarazione di conformità viene rilasciata sotto la responsabilità esclusiva di CIRCUTOR, con sede in Vial Sant Jordi, s/n – 08232 Viladecavalls (Barcelona) Spagna

prodotto:

**Analizzatori di reti pannello 96 x96**

Serie:

**CVM-C10**

MARCHIO:

**CIRCUTOR**

L'oggetto della dichiarazione è conforme alla pertinente normativa di armonizzazione dell'Unione Europea, a condizione che venga installato, mantenuto e utilizzato nell'ambito dell'applicazione per cui è stato prodotto, secondo le norme di installazione applicabili e le istruzioni del produttore.

2014/35/UE: Low Voltage Directive 2014/30/UE: Electromagnetic Compatibility Directive

2011/65/UE: RoHS2 Directive

È conforme alle seguenti normative o altri documenti normativi:

IEC 61010-1:2010-AMD1:2016 CSV Ed 3.0 IEC 61326-1:2012 Ed 2.0  
IEC 61000-6-2:2016 Ed 3.0 IEC 61000-6-4:2006-AMD1:2010 CSV Ed 2.1  
UL 61010-1, 3rd Edition, 2012-5

Anno di marcatura "CE": 2014



Viladecavalls (Spain), 19/07/2017  
General Manager: Ferran Gil Torné





CIRCUTOR, SA – Vial Sant Jordi, s/n  
08232 Viladecavalls (Barcelona) Spain  
(+34) 937 452 900 – info@circutor.com

**DEKLARACJA ZGODNOŚCI UE**

Niniejsza deklaracja zgodności zostaje wydana na wyłączną odpowiedzialność firmy CIRCUTOR z siedzibą pod adresem: Vial Sant Jordi, s/n – 08232 Viladecavalls (Barcelona) Hiszpania

produkt:

analityczny tablicowy 96x96

Seria:

**CVM-C10**

marka:

**CIRCUTOR**

Przedmiot deklaracji jest zgodny z odnośnymi wymaganiami prawodawstwa harmonizacyjnego w Unii Europejskiej pod warunkiem, że będzie instalowany, konserwowany i użytkowany zgodnie z przeznaczeniem, dla którego został wyprodukowany, zgodnie z mającymi zastosowanie normami dotyczącymi instalacji oraz instrukcjami producenta

2014/35/UE: Low Voltage Directive 2014/30/UE: Electromagnetic Compatibility Directive  
2011/65/UE: RoHS2 Directive

Jest zgodny z następującą(y)mi normą(ami) lub innym(i) dokumentem(ami) normatywnym(i):

IEC 61010-1:2010-AMD1:2016 CSV Ed 3.0 IEC 61326-1:2012 Ed 2.0  
IEC 61000-6-2:2016 Ed 3.0 IEC 61000-6-4:2006-AMD1:2010 CSV Ed 2.1  
UL 61010-1, 3rd Edition, 2012-5

Rok oznakowania "CE":

2014



Viladecavalls (Spain), 19/07/2017  
General Manager: Ferran Gil Torné





**CIRCUTOR, SA**

Vial Sant Jordi, s/n

08232 - Viladecavalls (Barcelona)

Tel.: (+34) 93 745 29 00 - Fax: (+34) 93 745 29 14

[www.circutor.com](http://www.circutor.com) [central@circutor.com](mailto:central@circutor.com)