

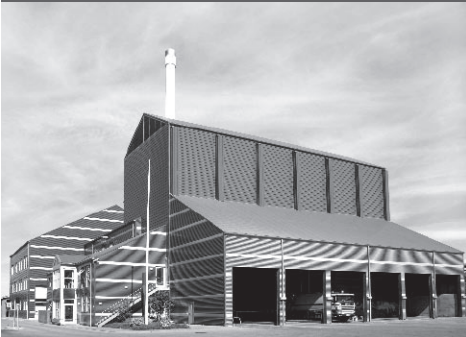

-power in control



DATA SHEET



Protection and Power Management, PPM-3

- Protection (ANSI)
- Options
- Engine control and interface
- M-logic (Micro PLC)
- Application
- Technical specifications
- Order specifications



DEIF A/S · Frisenborgvej 33 · DK-7800 Skive
Tel.: +45 9614 9614 · Fax: +45 9614 9615
info@deif.com · www.deif.com

Document no.: 4921240337H
SW version: 3.04.0 or later

1. General	
1.1. General.....	3
1.1.1. PPM-3.....	3
1.1.2. Unit control modes AUTO.....	3
1.1.3. Unit control modes SEMI.....	3
1.1.4. Unit control modes SWBD.....	3
1.1.5. Setup.....	3
1.1.6. Unit definition.....	3
1.1.7. Unit dimensions in mm (inches).....	4
2. Display	
2.1. Display layouts.....	5
2.1.1. About displays.....	5
3. Protection (ANSI)	
3.1. Protection (ANSI).....	8
3.1.1. Standard functions.....	8
4. Options	
4.1. Options.....	9
4.1.1. Hardware overview.....	10
4.1.2. Available variants	12
4.1.3. Available options.....	14
4.1.4. Available accessories.....	16
5. Engine control and interface	
5.1. Engine control and interface.....	17
6. M-Logic (Micro PLC)	
6.1. M-Logic (Micro PLC).....	18
6.1.1. M-Logic.....	18
7. Application	
7.1. Application.....	19
7.1.1. Plant operation.....	19
7.1.2. Configuration.....	19
7.1.3. Heavy consumer management.....	20
7.1.4. Load-dependent operation.....	20
7.1.5. Priority selection.....	20
7.1.6. Redundant CAN bus.....	20
7.1.7. Power management applications.....	21
8. Technical specifications	
8.1. Technical specifications.....	23
9. Order specification	
9.1. Order specification.....	27
9.1.1. Order specifications.....	27

1. General

1.1 General

1.1.1 PPM-3

The Protection and Power Management (PPM-3) is a very flexible controller for marine applications with microprocessor-based control units containing all necessary functions for protection and control of diesel generators, shaft generators, shore connections and bus tie breakers. It contains all necessary 3-phase measuring circuits and all values and alarms are presented on the LCD display.

The PPM-3 is a compact all-in-one unit designed for the following applications:

- Multiple gensets
- Split busbars with independent section control
- Ring bus connection
- Shaft generator and shore connection control
- Bus tie breaker control
- Emergency generator control

1.1.2 Unit control modes AUTO

Auto control means that the plant is controlled automatically by PPM-3, and genset starting and stopping is based on power demand (when in DG supply operation). Upon operator command, switching between different operation modes is done automatically.

1.1.3 Unit control modes SEMI

Semi-auto control is an operator-dependent auto mode. This means that genset start/stop, synchronisation and opening of the breaker is carried out by PPM-3 on operator command only. A diesel generator unit connected in semi-auto will not be a part of the load-dependent start/stop function.

1.1.4 Unit control modes SWBD

Switchboard control means that PPM-3 is disabled totally with regards to start/stop/synchronising and load sharing. The protection functions remain active.

1.1.5 Setup

Setup is easily done via a menu structure in the display (password-protected) or via the USB PC connection and the Multi-line 2 Windows-based PC utility software. The PC utility software can be downloaded free of charge from <http://www.deif.com>. The utility software offers additional features such as monitoring of all relevant information during commissioning, saving and downloading of settings and downloading of software updates.

1.1.6 Unit definition

PPM DG	Diesel generator controller
PPM SG	Shaft generator controller
PPM SC	Shore connection controller
PPM BTB	Bus tie breaker controller
PPM EDG	Emergency diesel generator controller

 One of the two CAN communications (1) is used for internal communication. CAN 2 is for communication options or redundant internal CAN.

1.1.7 Unit dimensions in mm (inches)

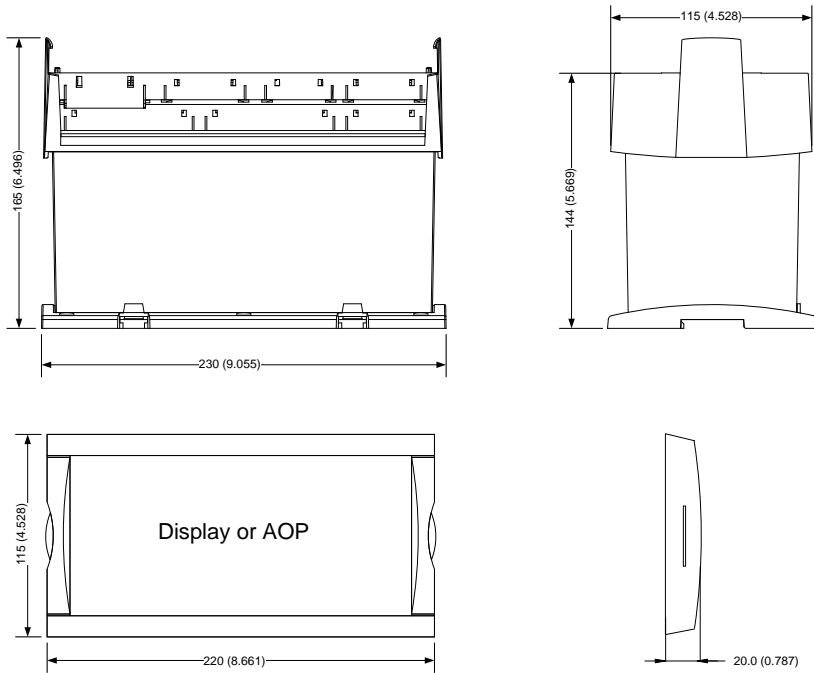

2. Display

2.1 Display layouts

2.1.1 About displays

The display is separate and can be installed directly on the main unit or in the front of the switchboard door (requires option J1 - display cable). Additional displays can be installed within 200 m.

Diesel generator display

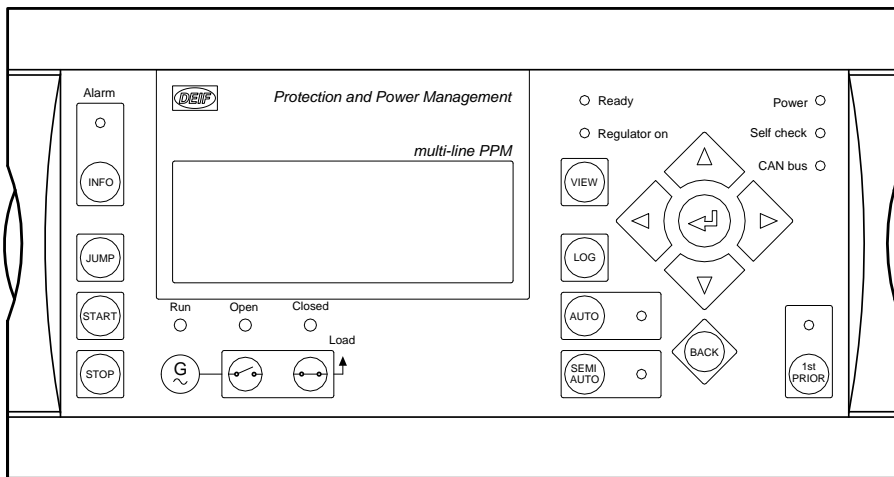

Shaft generator/shore connection display

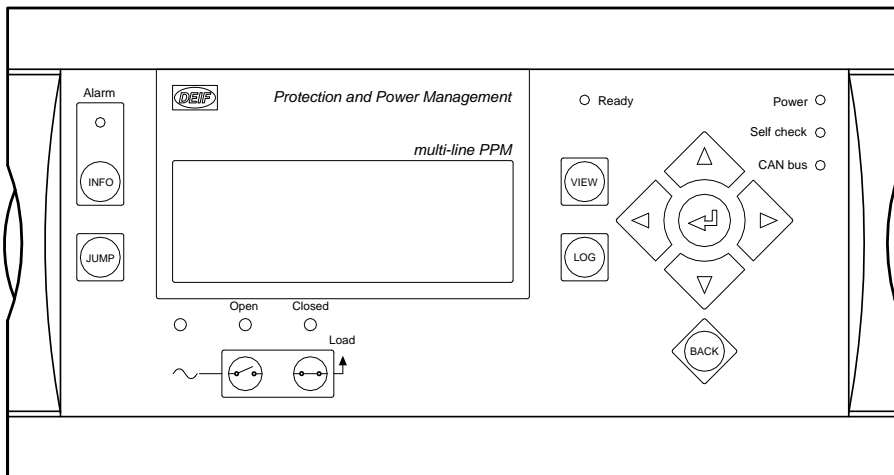

Bus tie breaker display

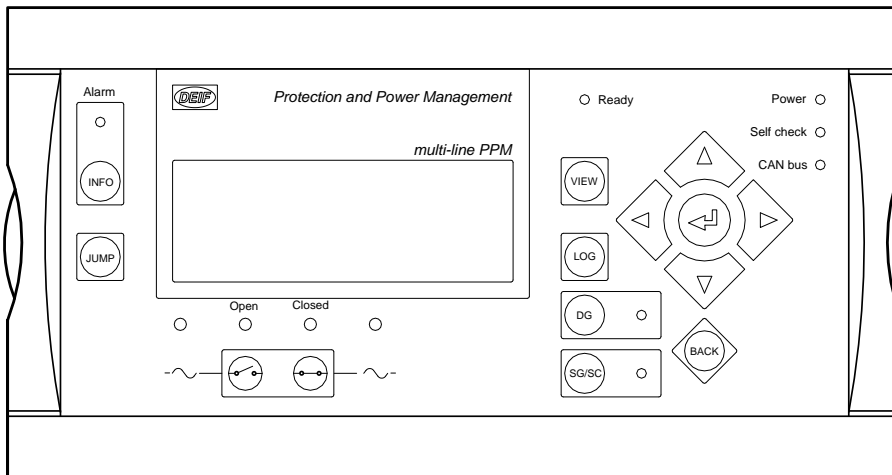

Emergency diesel generator display

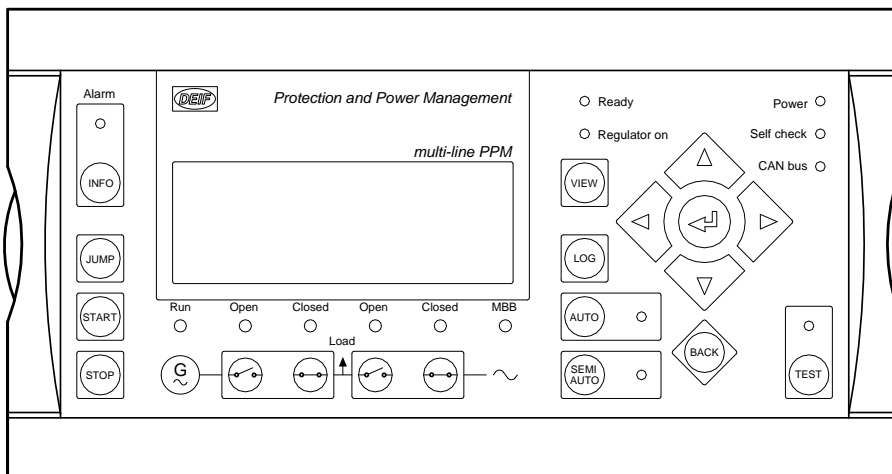

Additional operator panel display - AOP-1

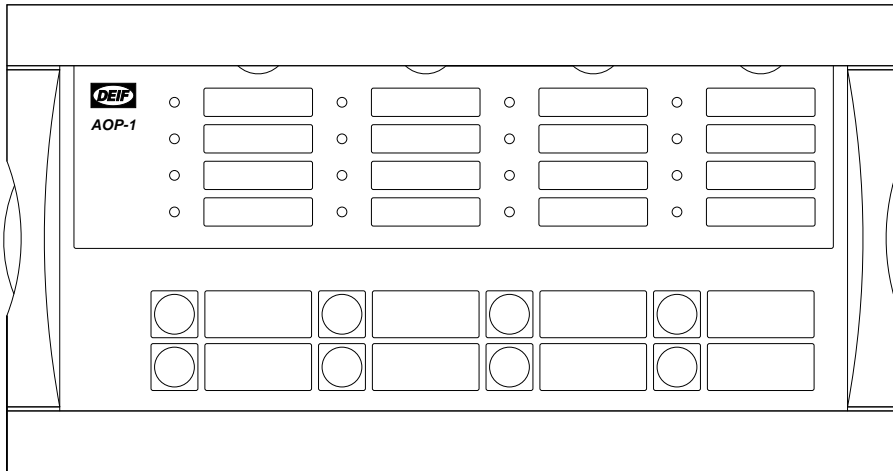

Additional operator panel display - AOP-2

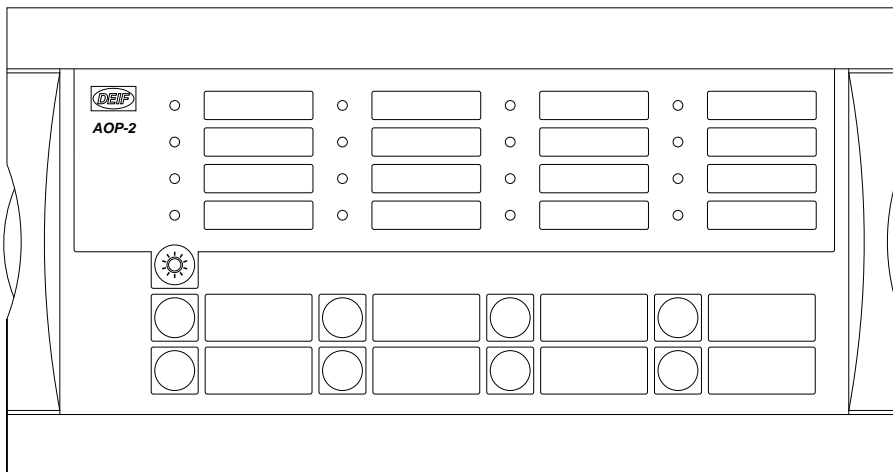

3. Protection (ANSI)

3.1 Protection (ANSI)

3.1.1 Standard functions

The following protection functions are included as standard functions:

Protection function	ANSI no. *	Levels
Generator reverse power	(32)	2 steps
Generator over-current	(50)	4 steps
Voltage-dependent over-current	(51V)	
Fast over-current	(51)	2 steps
Generator over-voltage	(59)	2 steps
Generator under-voltage	(27)	3 steps
Generator over-frequency	(81)	3 steps
Generator under-frequency	(81)	3 steps
Busbar over-voltage	(59 B)	3 steps
Busbar under-voltage	(27 B)	4 steps
Busbar over-frequency	(81 B)	3 steps
Busbar under-frequency	(81 B)	4 steps
Generator overload	(32)	5 steps
Current unbalance	(46)	
Voltage unbalance	(60)	
Overexcitation	(24)	
Loss of excitation	(40)	

* (ANSI# as per IEEE Std. C37.2-1996 (R2001) in parenthesis).

4. Options

4.1 Options

In order to perfectly match the product solution to specific applications, the functionality of the PPM-3 can be equipped with a number of available options. The options selected by the customer will be integrated in the standard PPM-3, hereby securing the same user interface unaffected by whether the application needs a highly complex or a more basic genset controller.

Refer to the Available options chapter to see available options.

4.1.1 Hardware overview

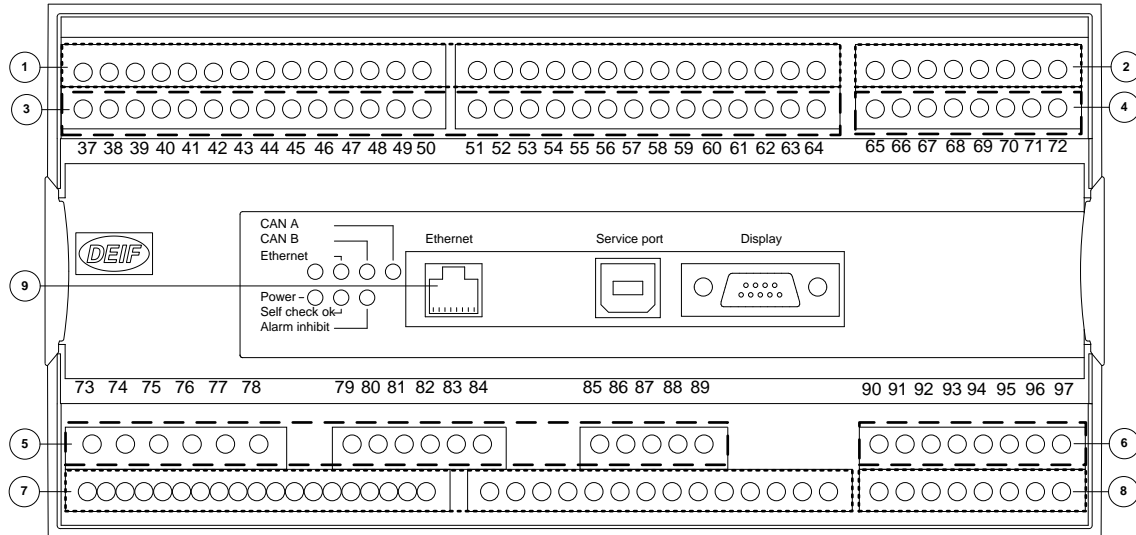

1: The numbers in the drawing above refer to slot numbers.

Hardware overview

Slot	Option	Description
Slot #1, terminal 1-28 Power supply (standard)		8-36 V DC supply, 11 W 1 × status output relay 5 × relay outputs 2 × pulse outputs (kWh, kvarh) 5 × digital inputs
Slot #2, terminal 29-36 Communication	H2	Modbus RTU (RS-485)
	H3	Profibus DP
	H8.2	External I/O modules
Slot #3, terminal 37-64 In-/outputs/load sharing		13 × digital inputs
		4 × relay outputs (standard)
	G3	Active power load sharing (standard) Reactive power load sharing (requires option D1)
Slot #4, terminal 65-72 Governor, AVR, in-/outputs	M14.4	4 × relay (standard)
	E1	2 × +/-20 mA out
	E2	2 × 0(4)-20 mA out

Slot	Option	Description
	EF2	1 × +/-20 mA out 1 × 0(4)-20 mA out
	EF4	1 × +/-20 mA out 2 × relay
	EF5	1 × PWM governor output 1 × +/-20 mA out for AVR 2 × relay
Slot #5, terminal 73-89 AC measuring (standard)		3 × generator voltage 3 × generator current 3 × busbar/mains voltage
Slot #6, terminal 90-97 In-/outputs	F1	2 × 0(4)-20 mA out, transducer
	M13.6	7 × digital inputs
	M14.6	4 × relay outputs
	M15.6	4 × 4-20 mA inputs
Slot #7, terminal 98-125 Engine I/F (standard)		8-36 V DC supply, 5 W 1 × magnetick pickup (MPU) 3 × multi-inputs 7 × digital inputs 4 × relay outputs
	G5	Power management (standard)
	H7	J1939
Slot #8, terminal 126-133 Engine communication, in-/outputs		MTU (MDEC) + J1939 (option H7)
	H8.8	External I/O modules
	M13.8	7 × digital inputs
	M14.8	4 × relay outputs
	M15.8	4 × 4-20 mA input
No. 9: Ethernet	N	Modbus TCP/IP EtherNet/IP SMS/e-mail alarms
No. 10: LED I/F		Display connection PC-programming connection



There can only be one hardware option in each slot. For example, it is not possible to select option H2 and option H3 at the same time, because both options require a PCB in slot #2.



Besides the hardware options shown on this page, it is possible to select the software options mentioned in "Available options".

4.1.2 Available variants

Type	Variant	Description	Item no.	Note
PPM-3	02	PPM-3 DG Diesel Generator controller	2911500030-02	One 3 m display cable is included as standard
PPM-3	03	PPM-3 SG Shaft Generator controller	2911500030-03	One 3 m display cable is included as standard
PPM-3	04	PPM-3 SC Shore Connection controller	2911500030-04	One 3 m display cable is included as standard
PPM-3	05	PPM-3 EDG Emergency Diesel Generator controller	2911500030-05	One 3 m display cable is included as standard
PPM-3	06	PPM-3 BTB Bus Tie Breaker controller	2911500030-06	One 3 m display cable is included as standard
PPM-3	07	PPM-3 DG Diesel Generator controller + H2	2911500030-07	One 3 m display cable is included as standard
PPM-3	08	PPM-3 SG Shaft Generator controller + H2	2911500030-08	One 3 m display cable is included as standard
PPM-3	09	PPM-3 SC Shore Connection controller + H2	2911500030-09	One 3 m display cable is included as standard
PPM-3	10	PPM-3 EDG Emergency Diesel Generator controller + H2	2911500030-10	One 3 m display cable is included as standard
PPM-3	11	PPM-3 BTB Bus Tie Breaker controller + H2	2911500030-11	One 3 m display cable is included as standard
PPM-3	12	PPM-3 DG Diesel Generator controller + H2 + F1	2911500030-12	One 3 m display cable is included as standard
PPM-3	13	PPM-3 SG Shaft Generator controller + H2 + F1	2911500030-13	One 3 m display cable is included as standard
PPM-3	14	PPM-3 SC Shore Connection controller + H2 + F1	2911500030-14	One 3 m display cable is included as standard
PPM-3	15	PPM-3 EDG Emergency Diesel Generator controller + H2 + F1	2911500030-15	One 3 m display cable is included as standard
PPM-3	16	PPM-3 BTB Bus Tie Breaker controller + H2 + F1	2911500030-16	One 3 m display cable is included as standard
PPM-3	17	PPM-3 DG Diesel Generator controller + F1	2911500030-17	One 3 m display cable is included as standard
PPM-3	18	PPM-3 SG Shaft Generator controller + F1	2911500030-18	One 3 m display cable is included as standard
PPM-3	19	PPM-3 SC Shore Connection controller + F1	2911500030-19	One 3 m display cable is included as standard
PPM-3	20	PPM-3 EDG Emergency Diesel Generator controller + F1	2911500030-20	One 3 m display cable is included as standard

Type	Variant	Description	Item no.	Note
PPM-3	21	PPM-3 BTB Bus Tie Breaker controller + F1	2911500030-21	One 3 m display cable is included as standard

4.1.3 Available options

Option	Description	Slot no.	Option type	Note
D	Voltage/var/PF control			Not available for PPM SG/SC and PPM BTB
D1	Constant voltage control (stand-alone)		Software	
	Constant reactive power control (parallel with mains)			
	Constant power factor control (parallel with mains)			
	Reactive load sharing (island paralleling with other generators)			
E and F	Analogue controller and transducer outputs			
E1	2 × +/-25 mA (GOV/AVR or transducer)	4	Hardware	Not with E2, EF2, EF4 or EF5 AVR output requires D1
E2	2 × 0(4)-20 mA (GOV/AVR or transducer)	4	Hardware	Not with E1, EF2, EF4 or EF5 AVR output requires D1
EF2	1 × +/-25 mA (GOV/AVR or transducer) 1 × 0(4)-20 mA (GOV/AVR or transducer)	4	Hardware	Not with E1, E2, EF4 or EF5 AVR output requires D1
EF4	1 × +/-25 mA (GOV/AVR or transducer) 2 × relay outputs (GOV/AVR or configurable)	4	Hardware	Not with E1, E2, EF2 or EF5 AVR output requires D1
EF5	1 × PWM (Pulse Width Modulated) output for CAT GOV+/-20 mA for AVR 2 × relay outputs (GOV/AVR or configurable)	4	Hardware	Not with E1, E2, EF2 or EF4 AVR output requires D1
F1	2 × 0(4)-20 mA (transducer)	6	Hardware	Not with M13.6, M14.6 or M15.6
H	Serial communication			
H2	Modbus RTU (RS-485)	2	Hardware	Not with H3, H8.2
H3	Profibus DP	2	Hardware	Not with H2, H8.2
H5	CAN bus: MTU (ADEC and MDEC) and all J1939 engine communication in option H7	8	Hardware	Not with H7, H8.8, M13.8, M14.8 or M15.8 Not available for PPM SG/SC and PPM BTB

Option	Description	Slot no.	Option type	Note
H7	CAN bus (J1939): Caterpillar: Perkins Cummins CM850/570: Scania (EMS) Detroit Diesel (DDEC): Scania (EMS S6) Deutz (EMR): Volvo Penta (EMS) Iveco (NEF/CURSORS): Volvo (EMS2) John Deere (JDEC)	7	Software	Not with H5 or redundant PMS CAN bus Not available for PPM SG/SC and PPM BTB
H8.X	External I/O modules	2, 8	Hardware	H8.2: Not with H2, H3, H8.8 H8.8: Not with H5, H8.2, M13.8, M14.8 or M15.8
M	Binary and analogue I/Os			
M13.X	7 binary inputs, configurable	6, 8	Hardware	M13.6: Not with F1, M14.6 or M15.6 M13.8: Not with H5, H8.8, M14.8 or M15.8
M14.X	4 relay outputs, configurable	6, 8	Hardware	M14.6: Not with F1, M13.6 or M15.6 M14.8: Not with H5, H8.8, M13.8 or M15.8
M15.X	4 analogue inputs, configurable, 4-20 mA	6, 8	Hardware	M15.6: Not with F1, M13.6, M14.6 or M15.8 M15.8: Not with H5, H8.8, M13.8, M14.8 or M15.6
N	Ethernet TCP/IP communication			
N	Modbus TCP/IP EtherNet/IP SMS/e-mail alarms		Hardware/software	
Q	Measurement accuracy			
Q1	Verified class 0.5		Other	

(ANSI# as per IEEE Std. C37.2-1996 (R2001) in parenthesis).



Options E1, E2, EF2, EF4 and EF5 are used for GOV/AVR control. Four relays are used as standard in the PPM-3 for GOV/AVR control. If selected, these options will replace the four relays.



Notice that not all options can be selected for the same unit. Refer to the paragraph "Hardware overview" in this data sheet for further information about the location of the options in the unit.

4.1.4 Available accessories

Accessories	Description	Item no.	Note
Operator panels			
Standard Display Unit, DU-2	For connection directly to base unit with display cable	2912210050	Specify product and folio (refer to the passage "Display layouts")
Additional Display Unit, DU-2 (X2)	For CAN bus connection to the standard display	2912890030	Two additional displays can be used with each PPM unit
Additional Operator Panel, AOP-1 (X3)	16 configurable LEDs and eight configurable push-buttons	2912890040	Max. one AOP-1 for each display unit
Additional Operator Panel, AOP-2 (X4)	16 configurable LEDs, eight configurable buttons and one status relay. CAN bus comm.	2912890050	Five AOP-2 units can be used with each PPM unit
Display gasket for IP54 (L)	Standard is IP40	1134510010	
Cables			
Display cable, 3 m		1022040076	
Display cable, 6 m (J2)		1022040057	
Display cable, 1 m (J6)		1022040064	
USB cable, 3 m (J7)	For PC utility software	1022040065	
Ethernet cable, crossed, 3 m (J4)	For option N	1022040055	
Documentation			
Designer's Reference Handbook (K1)		4189340671	
CD-ROM with complete documentation (K2)		2304230002	



Display gasket is required for RS-approved applications.

5. Engine control and interface

5.1 Engine control and interface

The PPM-3 is supplied with an engine interface I/O card with separate power supply and processor. The card is equipped with the following I/Os:

In-/outputs		Available
Multi-inputs	4-20 mA	3 (3)
	Digital inputs	
	Pt100	
	Pt1000	
	RMI	
	0-40 V DC	
Digital inputs		7 (4)
RPM (MPU)		1
Relays		4
CAN bus communication		2



The number in parenthesis indicates the number of user configurable in-/outputs.

6. M-Logic (Micro PLC)

6.1 M-Logic (Micro PLC)

6.1.1 M-Logic

This configuration tool is part of the PC utility software which is free of charge. With this tool, it is possible to customise the application to your needs. It is possible to dedicate specific functions or logical conditions to different inputs and outputs.

Logic	Item description (optional and saved in project file only)			
Logic 1	Item description (optional and saved in project file only)			
Event A	Operator	Event B	Operator	Event C
NOT <input type="checkbox"/> BUS high-volt 1: Alarms	OR	NOT <input type="checkbox"/> Not used	OR	NOT <input type="checkbox"/> Not used
Enable this rule: <input checked="" type="checkbox"/>	Output: Activate Secured Mode: C	Delay (sec.): 0		
Logic 2	Item description (optional and saved in project file only)			
Event A	Operator	Event B	Operator	Event C
NOT <input type="checkbox"/> Not used	OR	NOT <input type="checkbox"/> Not used	OR	NOT <input type="checkbox"/> Not used
Enable this rule: <input type="checkbox"/>	Output: Not used	Delay (sec.): 0		
Logic 3	Item description (optional and saved in project file only)			
Event A	Operator	Event B	Operator	Event C
NOT <input type="checkbox"/> Not used	OR	NOT <input type="checkbox"/> Not used	OR	NOT <input type="checkbox"/> Not used
Enable this rule: <input type="checkbox"/>	Output: Not used	Delay (sec.): 0		
Logic 4	Item description (optional and saved in project file only)			
Event A	Operator	Event B	Operator	Event C
NOT <input type="checkbox"/> Not used	OR	NOT <input type="checkbox"/> Not used	OR	NOT <input type="checkbox"/> Not used
Enable this rule: <input type="checkbox"/>	Output: Not used	Delay (sec.): 0		
Logic 5	Item description (optional and saved in project file only)			
Event A	Operator	Event B	Operator	Event C
NOT <input type="checkbox"/> Not used	OR	NOT <input type="checkbox"/> Not used	OR	NOT <input type="checkbox"/> Not used
Enable this rule: <input type="checkbox"/>	Output: Not used	Delay (sec.): 0		
Logic 6	Item description (optional and saved in project file only)			
Event A	Operator	Event B	Operator	Event C
NOT <input type="checkbox"/> Not used	OR	NOT <input type="checkbox"/> Not used	OR	NOT <input type="checkbox"/> Not used
Enable this rule: <input type="checkbox"/>	Output: Not used	Delay (sec.): 0		
Logic 7	Item description (optional and saved in project file only)			
Event A	Operator	Event B	Operator	Event C
NOT <input type="checkbox"/> Not used	OR	NOT <input type="checkbox"/> Not used	OR	NOT <input type="checkbox"/> Not used
Enable this rule: <input type="checkbox"/>	Output: Not used	Delay (sec.): 0		
Logic 8	Item description (optional and saved in project file only)			
Event A	Operator	Event B	Operator	Event C
NOT <input type="checkbox"/> Not used	OR	NOT <input type="checkbox"/> Not used	OR	NOT <input type="checkbox"/> Not used

7. Application

7.1 Application

The Protection and Power Management (PPM-3) controllers are able to handle applications with up to

- 8 bus tie breakers (BTB)
- 16 diesel generators (DG)
- 1 emergency breaker (EDG)
- 2 shaft generators (SHAFT)
- 2 shore connections (SHORE)

The basic functions are:

- All breakers can be synchronised by choice
- Load-dependent start/stop operation
- Priority selection of gensets
- Redundant communication between the controllers
- Plant divided into sections for individual functionality
- Load transfer
- Heavy consumer management
- Multi-master system

In a multi-master system, all vital data is broadcasted from all units to all units, giving all units knowledge of their own position in the application. This philosophy makes the application immune to a failing master controller.

7.1.1 Plant operation

The plant operation depends on the plant configuration, that is, if there are shaft generator(s), bus tie breaker(s), synchronisable shore connection(s) and/or an emergency diesel generator involved. Switching between different operation modes is done with push-buttons on the display.

Operation modes:

- Load sharing between diesel generators
- Fixed power (diesel generator)
- Load transfer between shaft and diesel generator
- Load transfer between shore connection and diesel generator
- Split busbar

The plant operational modes supported by the power management options are:

- Diesel generator operation
- Shaft generator operation
- Shore connection operation
- Split busbar(s) operation
- Emergency/harbour generator operation
- Ship-to-ship supply

The plant operational modes are configurable and it is possible to change them on the fly, dependent on the actual or desired situation. The plant can be divided into sections by several bus tie breakers, making it possible to run different operation modes in each section.

7.1.2 Configuration

The setup of the application is easily configured using a computer and the DEIF PC utility software.

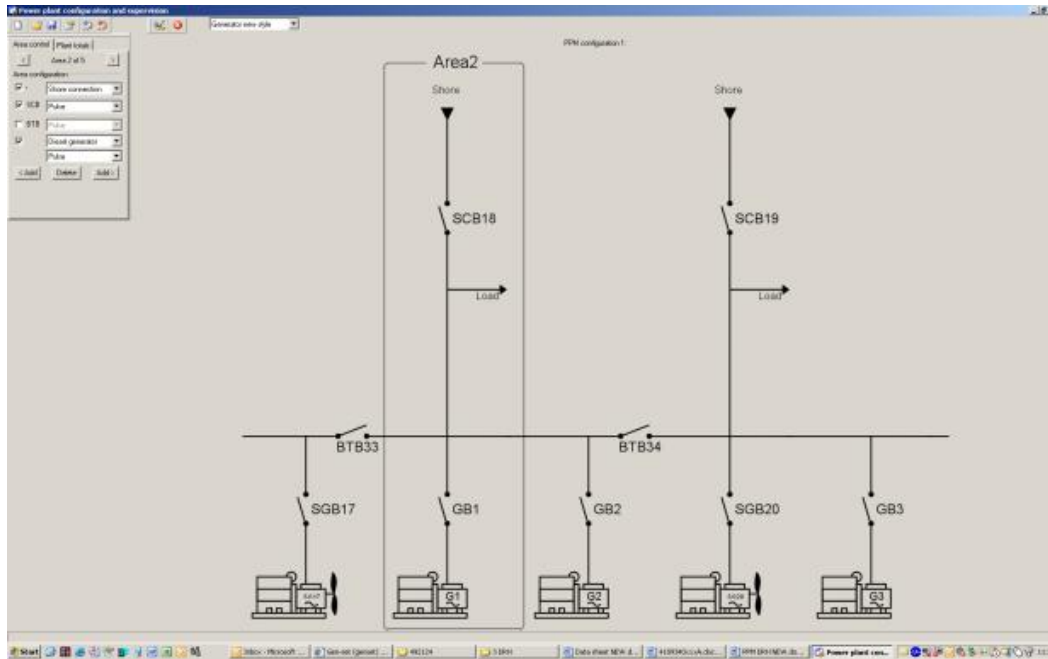

Your PC tool visualises it - the PPM-3 realises it.

7.1.3 Heavy consumer management

The heavy consumer management functions are available to ensure sufficient power capacity to handle the load either in terms of number of gensets or by soft starting the load. Available power can be reserved for heavy consumers with variable load, for example bow thrusters.

If a certain level of available power on the busbar is required to connect a heavy consumer, a function is available for starting additional generators. Furthermore, relays can be configured to activate when a specific level of available power is reached.

7.1.4 Load-dependent operation

The load-dependent starting and stopping of the gensets are based on a power available calculation. The next generator will start when the available power decreases below the adjustable set point. It will stop when too much power is available.

7.1.5 Priority selection

The start/stop priority of the diesel generators can be set in different ways:

- Manual selection with the 1st PRIOR push-button on each diesel generator unit
- Running hours
- Fuel-optimising calculating the best combination of generator kW size and the plant load. Works with up to 16 gensets.

7.1.6 Redundant CAN bus

In systems requiring extra operation reliability, redundant CAN bus communication lines can be used to provide backup.

7.1.7 Power management applications

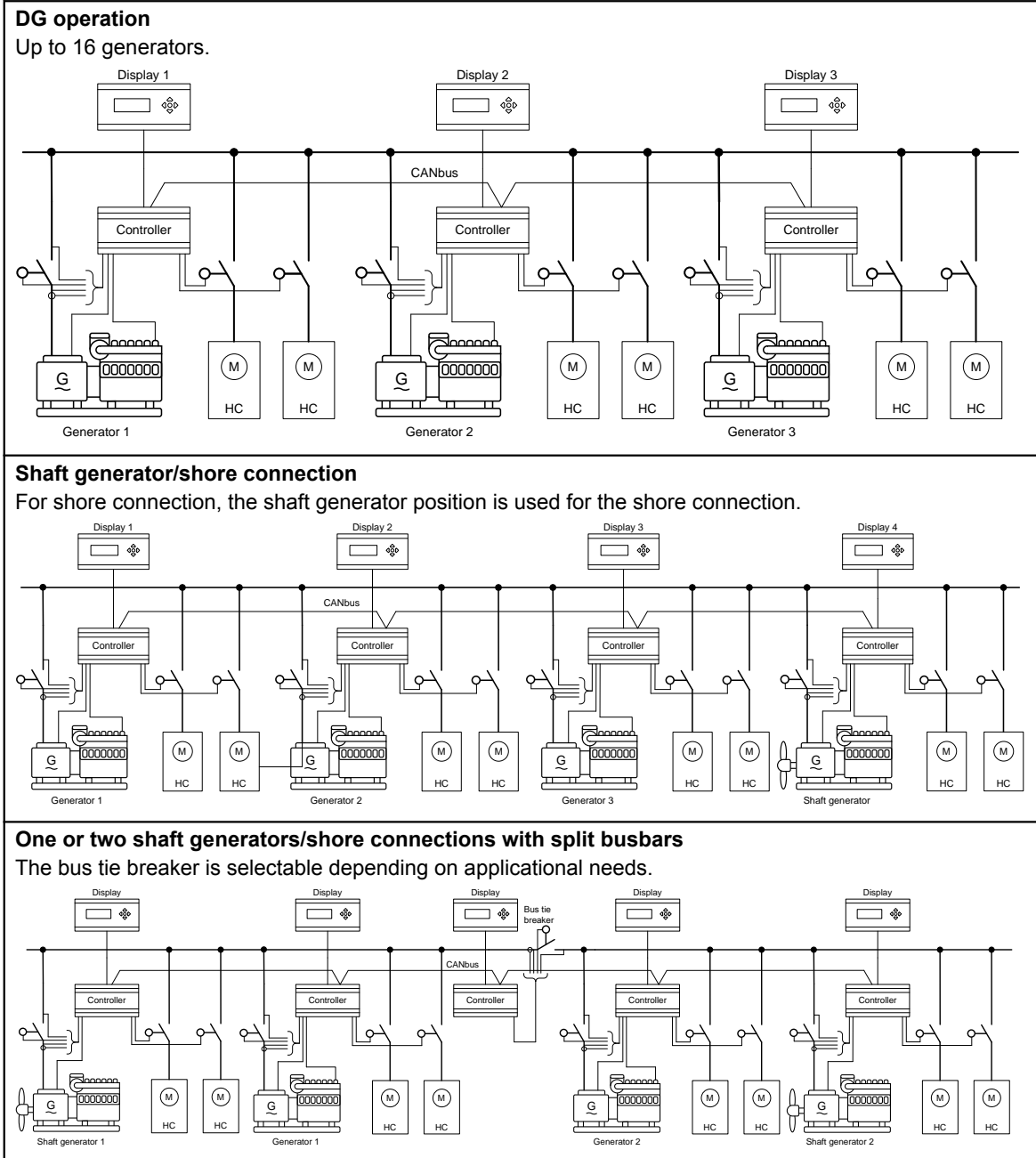

Multiple bus tie breakers

The bus tie breakers are selectable depending on applicational needs.

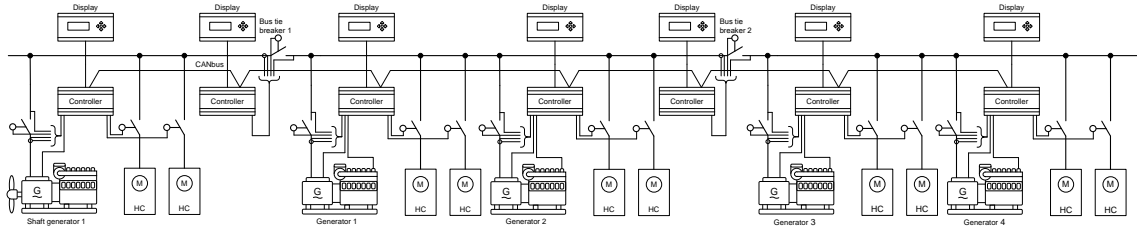

Emergency generator

The emergency generator can be combined with any other plant type.

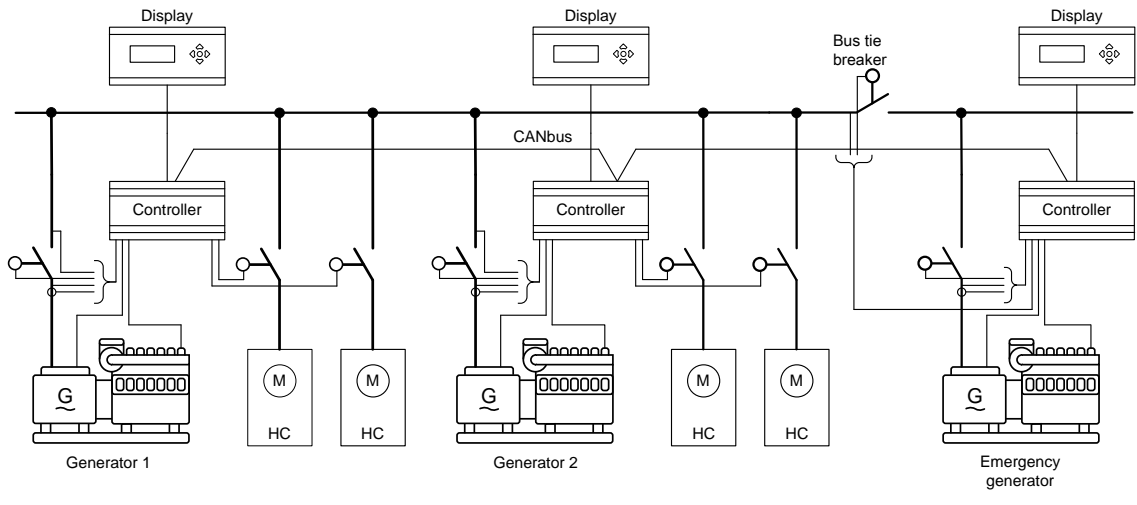

8. Technical specifications

8.1 Technical specifications

Accuracy	<p>Class 1.0 -25 to 15 to 30 to 70 °C Temperature coefficient: +/-0.2 % of full scale per 10 °C Positive, negative and zero sequence alarms: Class 1 within 5 % voltage unbalance Class 1.0 for negative sequence current Fast over-current: 3 % of 350 %*In Analogue outputs: Class 1.0 according to total range Option EF4/EF5: Class 4.0 according to total range To IEC/EN60688</p>
Operating temperature	<p>-25 to 70 °C (-13 to 158 °F) -25 to 60 °C (-13 to 140 °F) if the option N is available in the controller (UL/cUL Listed: Max. surrounding air temperature: 55 °C/131 °F)</p>
Storage temperature	-40 to 70 °C (-40 to 158 °F)
Climate	97 % RH to IEC 60068-2-30
Operating altitude	<p>0 to 4000 m above sea level Derating 2001 to 4000 m above sea level: Max. 480 V AC phase-phase 3W4 measuring voltage Max. 690 V AC phase-phase 3W3 measuring voltage</p>
Measuring voltage	<p>100-690 V AC +/-20 % (UL/cUL Listed: 600 V AC phase-phase) Consumption: Max. 0.25 VA/phase</p>
Measuring current	<p>-1 or -5 A AC (UL/cUL Listed: From CTs 1-5 A) Consumption: Max. 0.3 VA/phase</p>
Current overload	<p>4 × I_n continuously 20 × I_n, 10 sec. (max. 75 A) 80 × I_n, 1 sec. (max. 300 A)</p>
Measuring frequency	30-70 Hz
Aux. supply	<p>Terminals 1 and 2: 12/24 V DC nominal (8 to 36 V DC operational). Max. 11 W consumption Battery voltage measurement accuracy: ±0.8 V within 8-32 V DC @ -25 to 70 °C, ±0.5 V within 8-32 V DC @ 20 °C Terminals 98 and 99: 12/24 V DC nominal (8 to 36 V DC operational). Max. 5 W consumption 0 V DC for 10 ms when coming from at least 24 V DC (cranking dropout) The aux. supply inputs are to be protected by a 2 A slow blow fuse. (UL/cUL Listed: AWG 24)</p>
Binary inputs	Optocoupler, bi-directional. ON: 8-36 V DC. Impedance: 4.7 kΩ. OFF: <2 V DC

Analogue in-puts	0(4)-20 mA: Impedance: 50 Ω . Not galvanically separated RPM (MPU): 2-70 V AC, 10-10000 Hz, max. 50 k Ω
Multi-inputs	0(4)-20 mA: 0-20 mA, +/-1 %. Not galvanically separated Binary: Max. resistance for ON detection: 100 Ω . Not galvanically separated Pt100/1000: -40 to 250 $^{\circ}$ C, +/-1 %. Not galvanically separated. To IEC/EN60751 RMI: 0-1700 Ω , +/-2 %. Not galvanically separated V DC: 0-40 V DC, +/-1 %. Not galvanically separated
Relay outputs	Electrical rating: 250 V AC/30 V DC, 5 A. (UL/cUL Listed: 250 V AC/24 V DC, 2 A resistive load) Thermal rating @ 50 $^{\circ}$ C: 2 A: continuously. 4 A: t_{on} = 5 sec., t_{off} = 15 sec. (Unit status output: 1 A)
Open collector outputs	Supply: 8-36 V DC, max. 10 mA
Analogue out-puts	0(4)-20 mA and +/-25 mA. Galvanically separated. Active output (internal supply). Load max. 500 Ω . (UL/cUL Listed: Max. 20 mA output) Update rate: Transducer output: 250 ms. Regulator output: 100 ms
Analogue load sharing lines	-5 to 0 to +5 V DC. Impedance: 23.5 k Ω
Galvanic separation	Between AC voltage and other I/Os: 3250 V, 50 Hz, 1 min. Between AC current and other I/Os: 2200 V, 50 Hz, 1 min. Between analogue outputs and other I/Os: 550 V, 50 Hz, 1 min. Between binary input groups and other I/Os: 550 V, 50 Hz, 1 min.
Response times (delay set to min.)	Busbar: Over-/under-voltage: <50 ms Over-/under-frequency: <50 ms Voltage unbalance: <250 ms Generator: Reverse power: <250 ms Over-current: <250 ms Voltage-dependent over-current: <250 ms Fast over-current: <40 ms Over-/under-voltage: <250 ms Over-/under-frequency: <350 ms Overload: <250 ms Current unbalance: <250 ms Voltage unbalance: <250 ms Reactive power import: <250 ms Reactive power export: <250 ms Overspeed: <500 ms Digital inputs: <250 ms Emergency stop: <200 ms Multi-inputs: <800 ms Wire failure: <600 ms
Mounting	DIN-rail mount or base mount with six screws
Safety	To EN 61010-1, installation category (over-voltage category) III, 600 V, pollution degree 2 To UL 508 and CSA 22.2 no. 14-05, over-voltage category III, 600 V, pollution degree 2

EMC/CE	To EN 61000-6-2, EN 61000-6-4, IEC 60255-26, IEC 60533 Power distribution zone, IACS UR E10 Power distribution zone
Vibration	3-13.2 Hz: 2mm _{pp} . 13.2-100 Hz: 0.7 g. To IEC 60068-2-6 & IACS UR E10 10-60 Hz: 0.15mm _{pp} . 60-150 Hz: 1 g. To IEC 60255-21-1 Response (class 2) 10-150 Hz: 2 g. To IEC 60255-21-1 Endurance (class 2)
Shock (base mount)	10 g, 11 ms, half sine. To IEC 60255-21-2 Response (class 2) 30 g, 11 ms, half sine. To IEC 60255-21-2 Endurance (class 2) 50 g, 11 ms, half sine. To IEC 60068-2-27
Bump	20 g, 16 ms, half sine. To IEC 60255-21-2 (class 2)
Material	All plastic materials are self-extinguishing according to UL94 (V1)
Plug connections	AC current: 0.2-4.0 mm ² stranded wire. (UL/cUL Listed: AWG 18) AC voltage: 0.2-2.5 mm ² stranded wire. (UL/cUL Listed: AWG 20) Relays: (UL/cUL Listed: AWG 22) Terminals 98-116: 0.2-1.5 mm ² stranded wire. (UL/cUL Listed: AWG 24) Other: 0.2-2.5 mm ² stranded wire. (UL/cUL Listed: AWG 24) Display: 9-pole Sub-D female Service port: USB A-B
Tightening torque	0.5 Nm (4.4 lb-in)
Protection	Unit: IP20. Display: IP40 (IP54 with gasket: Option L) Display: IP54 is required for RS-approved applications (UL/cUL Listed: Type Complete Device, Open Type). To IEC/EN 60529
Governors	Multi-line 2 interfaces to all governors, including GAC, Barber-Colman, Woodward and Cummins See interfacing guide at http://www.deif.com
Approvals	UL/cUL Listed to UL508. UL/cUL Recognized to UL2200
UL markings	Wiring: Use 60/75 °C copper conductors only Mounting: For use on a flat surface of type 1 enclosure Installation: To be installed in accordance with the NEC (US) or the CEC (Canada)
AOP-2	Maximum ambient temperature: 60 °C Wiring: Use 60/75 °C copper conductors only Mounting: For use on a flat surface of type 3 (IP54) enclosure. Main disconnect must be provided by installer Installation: To be installed in accordance with the NEC (US) or the CEC (Canada)
Tightening torque	For further information, refer to the "Installation Instructions"
DC/DC converter for AOP-2	Tightening torque: 0.5 Nm (4.4 lb-in) Wire size: AWG 22-14
Tightening torque	0.5 Nm (4.4 lb-in)

Weight	Base unit: 1.6 kg (3.5 lbs.) Option J1/J3/J6: 0.2 kg (0.4 lbs.) Option J2: 0.4 kg (0.9 lbs.) Display: 0.4 kg (0.9 lbs.)
---------------	--

9. Order specification

9.1 Order specification

9.1.1 Order specifications

Variants

Mandatory information			Additional options to the standard variant					
Item no.	Type	Variant no.	Option	Option	Option	Option	Option	Option

Example:

Mandatory information			Additional options to the standard variant					
Item no.	Type	Variant no.	Option	Option	Option	Option	Option	Option
2911500030-07	PPM-3 Diesel Generator controller + H2	07	D1	E1				

Accessories

Mandatory information		
Item no.	Type	Accessory

Example:

Mandatory information		
Item no.	Type	Accessory
1022040065	Accessories for PPM-3	USB cable, 3 m (J7)

DEIF A/S reserves the right to change any of the above.