



Cable drag chain systems







EasyLine cable drag chains
Simple filling with the Easy mechanism

from page 62

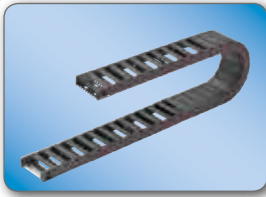

MultiLine cable drag chains
Compact dimensions, can be supplied in open and closed designs

from page 68



ModulLine cable drag chains
Extensive shelving system/interior division, can be supplied in open and closed designs, quiet running

from page 162

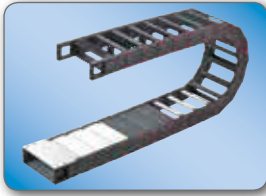

PowerLine cable drag chains
Opens on both sides, for high additional loads and long travel distances, open and closed designs available, variable widths via aluminium crossbars

from page 186



HeavyLine cable drag chains
Very high tensile strength, for high additional loads and long travel distances, opens on both sides, variable widths via aluminium crossbars

from page 290



Murrplastik legacy products
(do not use for new-build projects)
Tried-and-tested ranges, still in stock, not to be used for new-build projects

from page 330



Strain relief systems
Strain relief and Steel Fix bow clamps

Page 421



Appendix
Protection classes, fire classifications, directives, chemical resistances and other information

Page 431



Catalog overview	Page	7
Table of Contents	Page	8 – 9
Success doesn't happen overnight– over 30 years of passion for innovation	Page	10 – 11
Click lock – Click - and you're done	Page	12
Flexible shelving system	Page	13
Variable crossbars and covers	Page	14
The best connections	Page	15
Integrated strain relief – Economic on time and space	Page	16
Bracket bar	Page	17
Increased service life of the chain in gliding applications	Page	18
Gliding plates for side-mounted position	Page	19
Noise damping system	Page	20
Guide channels VAW with damper	Page	21
Guide channel VAW	Page	22
Confectioning connect4motion	Page	23
Atex cable drag chains	Page	24
Electrostatic discharges	Page	25
Clean room cable drag chains	Page	26
Visual differentiation	Page	27
Corporate Identity – Individual cable drag chain identification	Page	28
Selection criteria for cable drag chains	Page	29
Selection tables	Page	30 – 35
Installation options of cable drag chains	Page	36
Cable drag chain system planning form	Page	37 – 38
Cable drag chain cable request form	Page	39
Cable confectioning form	Page	40
Glossary	Page	41 – 43
Cable drag chain systems sorted by interior height	Page	44 – 61

CABLE DRAG CHAIN SYSTEMS

Product line	Type	Variation	Inside width		
EasyLine	MP 10.1	open	0.39 in (10 mm))	Page	62 – 67
MultiLine	MP 14	open	0.55 in (14 mm)	Page	68 – 73
MultiLine	MP 15	open	0.55 in (14 mm)	Page	74 – 79
MultiLine	MP 18.1/MP 18.2	open	0.71 in (18 mm)	Page	80 – 85
MultiLine	MP 18.4	open	0.71 in (18 mm)	Page	86 – 91
MultiLine	MP 20	open	0.79 in (20 mm)	Page	92 – 97
MultiLine	MP 3000	open	1.02 in (26 mm)	Page	98 – 105
MultiLine	MP 25G	open	0.98 in (25 mm)	Page	106 – 113
MultiLine	MP 35.1/MP 35.2	open	1.38 in (35 mm)	Page	114 – 125
MultiLine	MP 36G	open	1.42 in (36 mm)	Page	126 – 133
MultiLine	MP 43G	open	1.50 in (38 mm)	Page	134 – 141
MultiLine	MP 45.1/MP 45.2	open	1.77 in (45 mm)	Page	142 – 153
MultiLine	MP 65G	open	2.36 in (60 mm)	Page	154 – 161
ModulLine	MP 25.1/2	open	0.98 in (25 mm)	Page	162 – 173
ModulLine	MP 25.3/4	closed	0.98 in (25 mm)	Page	162 – 173
ModulLine	MP 30.1/2	open	1.18 in (30 mm)	Page	174 – 185
ModulLine	MP 30.3/4	closed	1.18 in (30 mm)	Page	174 – 185
PowerLine	MP 32.2	open	1.26 in (32 mm)	Page	186 – 201
PowerLine	MP 32.3	closed	1.18 in (30 mm)	Page	186 – 201
PowerLine	MP 41.2	open	1.65 in (42 mm)	Page	202 – 217
PowerLine	MP 41.3	closed	1.50 in (38 mm)	Page	202 – 217
PowerLine	MP 52.2	open	2.05 in (52 mm)	Page	218 – 233
PowerLine	MP 52.3	closed	1.98 in (48 mm)	Page	218 – 233
PowerLine	MP 52.2-D	open	2.05 in (52 mm)	Page	234 – 249
PowerLine	MP 52.3-D	closed	1.98 in (48 mm)	Page	234 – 249
PowerLine	MP 52.4	open	2.05 in (52 mm)	Page	250 – 265
PowerLine	MP 52.5	closed	1.98 in (48 mm)	Page	250 – 265

PowerLine	MP 52.6	open	2.05 in (52 mm)	Page	266 – 275
PowerLine	MP 52.7	closed	1.98 in (48 mm)	Page	266 – 275
PowerLine	MP 62.4	open	2.44 in (62 mm)	Page	276 – 289
HeavyLine	MP 62.2	open	2.44 in (62 mm)	Page	290 – 303
HeavyLine	MP 62.3	closed	2.44 in (62 mm)	Page	290 – 303
HeavyLine	MP 82.2	open	3.23 in (82 mm)	Page	304 – 317
HeavyLine	MP 82.3	closed	2.91 in (74 mm)	Page	304 – 317
HeavyLine	MP 102.2	open	4.09 in (104 mm)	Page	318 – 329

Murrplastik legacy products *(do not use for new-build projects)*

Legacy	MP 32	open	1.26 in (32 mm)	Page	330 – 343
Legacy	MP 35	open	1.34 in (34 mm)	Page	344 – 351
Legacy	MP 41	open	1.65 in (42 mm)	Page	352 – 365
Legacy	MP 44	open	1.57 in (40 mm)	Page	366 – 373
Legacy	MP 52.1	open	2.05 in (52 mm)	Page	374 – 387
Legacy	MP 62.1	open	2.44 in (62 mm)	Page	388 – 399
Legacy	MP 66	open	2.36 in (60 mm)	Page	400 – 407
Legacy	MP 72	open	2.83 in (72 mm)	Page	408 – 419

STRAIN RELIEF SYSTEMS

Introduction	Page	422 – 423
Benefits	Page	424 – 425
Selection criteria/ Guide to system design	Page	426
Design / Structure	Page	427
Strain relief system type ZL-C set and type ZL	Page	428
Strain relief system type ZL / two-tier strain relief system	Page	429
Steel Fix bow clamp	Page	430

APPENDIX

Protection classes DIN EN 60529	Page	432
Fire classification according to UL 94, DIN 5510	Page	433
Material characteristics	Page	434 – 435
Information about materials	Page	436 – 437
Chemical resistances of plastics	Page	438 – 439

SUCCESS DOESN'T HAPPEN OVERNIGHT



A SELECTION OF OUR INNOVATIONS FOR YOUR ADVANTAGE:

- 1984** First cable drag chain that can be opened
- 1987** Crossbars pivotable on both sides
- 1988** Bayonet stop system
- 1994** Integrated strain relief plate
- 1994** Guide channel system with releasable connecting glide rails
- 1996** Center piece for guide channel systems aligned in parallel
- 1997** Guide channel system with multiple grooves
- 1998** Crossbar connectors for greater stability with large chain widths
- 2001** PowerLine 2nd Generation Generation
- 2002** PowerLine shelving system for optimised chain compartment
- 2003** Magnet chain technology for non-contact gliding
- 2005** MultiLine series
- 2007** Brush supports for optimum cable positioning in the neutral strand
- 2008** ModulLine series
- 2011** Bracket bar for integration of large-diameter media conduits into an cable drag chain system
- 2013** Sliding blocks for higher service life of the chain
- 2015** PowerLine MP 52.6 for long travel distance
- 2016** PowerLine light series
- 2016** noiseLESS guide channel system
- 2016** MultiLine MP 45 with additional damper option
- 2017** Gliding plates for Power- and HeavyLine

OVER 30 YEARS OF PASSION FOR INNOVATION



www.mp.de

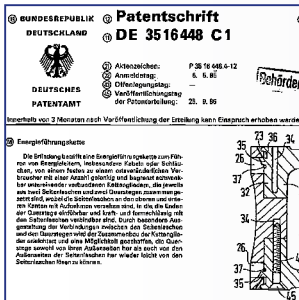

1984



1987



1988



1994



1994



2000



2003



2007



2008



2011



2013



2015



2016



2016



2016



2017

CLICK LOCK CLICK – AND YOU’RE DONE



FAST AND EASY

The crossbars can be fitted and removed quickly and with very little effort. Position the screwdriver between side link and crossbar and slightly turn it to open the click lock. Retrofitting a cable in the cable drag chain is also a quick and simple task. Assembly is even simpler. Position the crossbar in the side links and lock the click lock by hand.

With the click lock it is child’s play. Fitting and removal are rarely quicker or simpler without compromising stability.



- Quick assembly: click and go!
- REFA time and motion study conducted
- Assembly without tools
- Easy assembly
- Incredibly simple to retrofit cables

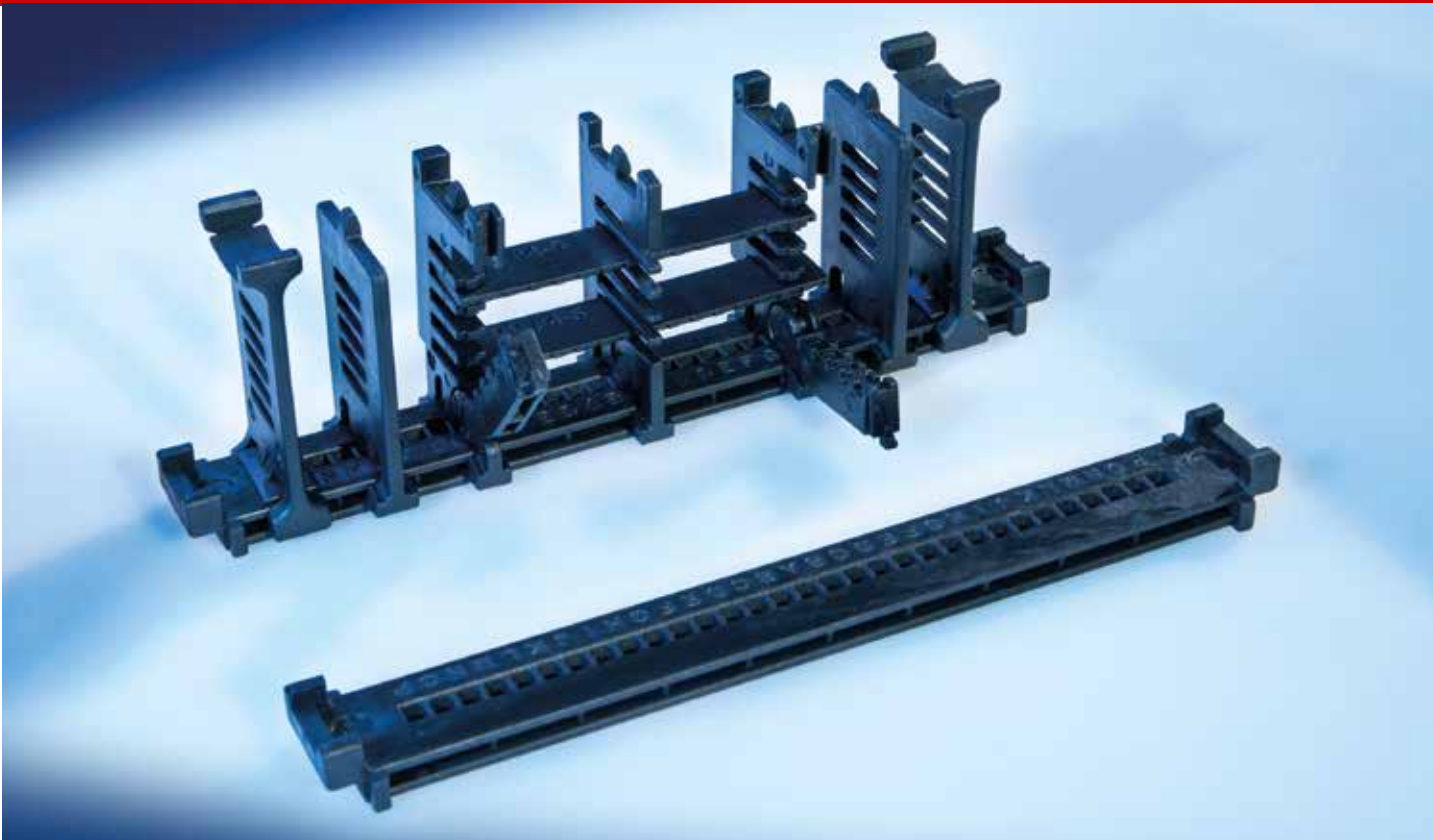

EXTREMELY VERSATILE

Equipping the chain with cables is made simpler by using separable shelf supports

The multitude of combination options means that the perfect shelving system can be put together for any application.

The shelf separators lock firmly into the crossbars and, once in place, they cannot slip. No matter what type of installation – horizontal, backwards, etc. – the cables stay in the position that was originally intended. This means: a long service life and no uneven wear to the chain.



- Easy assembly
- REFA time and motion study conducted
- Lockable separator, fixed position
- Rapid assembly
- Modifications possible when installed

VARIABLE CROSSBARS AND COVERS



VARIABLE

Crossbars/covers come in two alternative versions: plastic or aluminium. The plastic version is standard for crossbars and can be supplied in a range of widths. The aluminium version can be supplied in any width.

FIXED

In both the plastic and the aluminium versions, the separators lock into the crossbar/cover and are thus fixed in place. The separators remain in their original position regardless of the type of installation and any chain movement. The crossbars and separators form a stable unit.



- Flexible adjustment due to closely spaced lock tabs
- Fixed with lock tabs
- Variable length
- Extremely stable

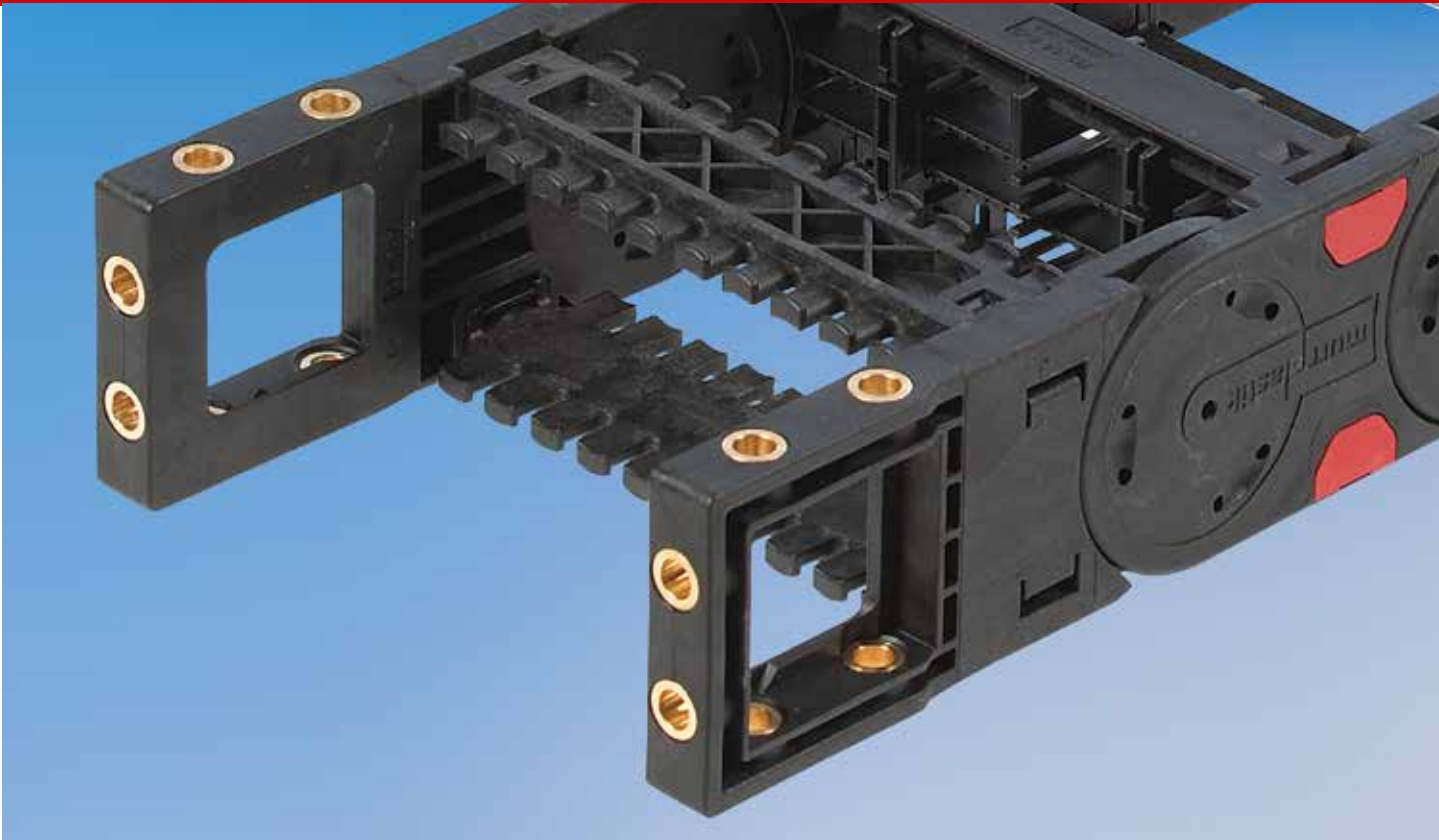

FAST AND EASY TO ASSEMBLE

Metal bushes are injected permanently into the plastic in the chain bracket. There are two types of bushings: with our without thread. The bushings are offered without thread as standard.

Both types of bush inhibit cold flow properties during screwing, thus effecting an extremely good fit. The threaded bush is screwed directly without a nut.



- No cold flow deformation
- Quick
- Secure fastening
- Compact

INTEGRATED STRAIN RELIEF SAVES TIME AND SPACE



SIMPLE AND SAFE STRAIN RELIEF

No cumbersome special design for cable strain relief. Everything is quick and safe with the Murrplastik cable drag chain system.

Special strain relief crossbars are used on the chain bracket. The strain relief is effected by cable ties. The cable can be fixed on the strain relief plate on two sides.

This integrated strain relief system is very quick to assemble and is extremely economical on space.

The Steel Fix bow clamps are mounted on the C-rail integrated into the chain bracket. This strain relief mechanism is impressively easy to fit and very secure. One Steel Fix bow clamp can provide strain relief for up to three cables.



- Easy to assemble
- Compact design
- Economical
- Saves space
- Secure strain relief



INTEGRATION OF MEDIA CONDUITS

Large-diameter conduits are routed securely by using bracket bars. These bracket bars can be supplied in various sizes.

Mounting is either on the crossbars or on the closed cover. Thanks to the modular design, retrofitting with bracket bars is also possible at any time.

Bracket bars are available for the following cable drag chains:

MP 32.2 / MP 32.3 ALU

MP 41.2 / MP 41.3

MP 52.2 / MP 52.3 / MP 52.4 / MP 52.5

MP 62.2 / MP 62.3 / MP 62.4 / MP 62.5 ALU

MP 82.2 / MP 82.3



- Modular system
- Available for crossbars and covers
- Can be supplied in a range of sizes
- Can be retrofitted

EXTENSION OF THE SERVICE LIFE OF THE CABLE DRAG CHAIN IN GLIDING APPLICATION



SLIDING BLOCKS - INNOVATION AGAINST WEAR AND TEAR

Cable drag chains that are used in horizontal gliding applications, with travel of longer than three meters, are often subjected to very high mechanical loads.

Murrplastik Systemtechnik has developed a simple and clever solution to address this problem: the sliding block. The sliding blocks are fitted onto the side links in the cable drag chain's inside bend without the need for any kind of tools. A screwdriver may be needed merely to disengage a sliding block for removal. As a result, when the wear limit is reached, only the comparatively inexpensive sliding blocks have to be replaced and not the complete cable drag chain.

Practical tests show that cable drag chains can gain as much as a fivefold extension to their service life by using sliding blocks. An investment that pays for itself in a very short time.



WITH SLIDING BLOCK



WITHOUT SLIDING BLOCK

Sliding blocks are available for the following cable drag chains:

MP 32.2 / MP 32.3 ALU

MP 41.2 / MP 41.3

MP 52.2 / MP 52.3 / MP 52.4 / MP 52.5

MP 62.2 / MP 62.3 / MP 62.4 / MP 62.5 ALU

MP 82.2 / MP 82.3

- Wear-reducing
- Extension of the service life by up to five times
- Easy assembly and disassembly
- Interchangeable

GLIDING PLATES FOR HORIZONTAL SIDE-MOUNTED POSITION



www.mp.de



GLIDING PLATES – CONTROLLED WEAR

Gliding plates are used with cable drag chains in horizontal side-mounted position. The gliding plates are snapped into the side links instead of using side link locks (GLP 8 and GLP 10, no tools required) or they are screwed directly to the side links (GLP 4 and GLP 5).

This allows the cable drag chain to slide on the gliding plates and not on the side links. Depending on the application, the service life of the cable drag chain may be extended two-fold, by using slide plates.

The wear limit for all gliding plates is 2.5 mm. Once the wear limit is reached, the material thickness on the sliding surface of the gliding plate is 4.5 mm. We recommend replacing the cable drag chain when this limit has been reached.



GLP 5 SLIDE PLATE



GLP 8 SLIDE PLATE

Gliding plates are available for the following cable drag chains:

MP 41.2 / MP 41.3
MP 52.2 / MP 52.3 / MP 52.4 / MP 52.5
MP 62.4 / MP 62.5 ALU
MP 82.2 / MP 82.3 / MP 102.2

- Doubling of the service life
- Runs more quiet through significantly reduced polygon effect.
- Cable drag chain can also be opened in side-mounted position
- For GLP 8 and GLP 10 no tool required
- Cable drag chains are supplied completely mounted with the gliding plates

NOISE REDUCTION SYSTEM



NOISE REDUCTION SYSTEM

Thanks to the innovative development of the damping elements the noise emission can be reduced by up to 10 dB(A) compared to conventional cable drag chains without damper.

The integrated damping elements function in the inside bend stops and facilitate a significantly quieter unrolling of the chain links.

Since a noise reduction by 10 dB(A) is already perceived as half the noise emission, it is therefore considered a much quieter environment, conducive to concentrated work.

The damping elements are available for the cable drag chain series MP 35.1/MP 35.2, MP 45.1/MP 45.2, MP 52.2-D/MP 52.3-D, MP 52.4/ MP 52.5, MP 62.4/ MP62.5 ALU.



- Reduction of the noise emission by up to 10 dB(A)
- Significantly quieter unrolling of the chain links.
- Completely assembled system

GUIDE CHANNELS VAW WITH DAMPER



REDUCTION OF THE NOISE EMISSION

The use of cable drag chains generates considerable noise, especially at higher speeds. The reason for this is the non-circular rolling of the cable drag chain links on the surface – the so-called polygon effect.

As a solution to reduce the noise emission Murrplastik offers variable guide channel systems with integrated damping elements. This reduces disturbing noise by up to 20 dB(A)

Available variants:

VAW 146, noiseLESS NL30, noiseLESS NL35

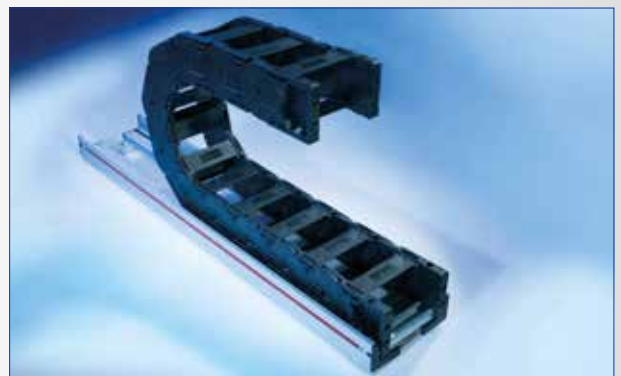

- Reduction of the noise emission by up to 20 dB(A)
- Quick and easy assembly
- Salt-water resistant and corrosion proof
- Variable chain widths

VAW GUIDE CHANNELS

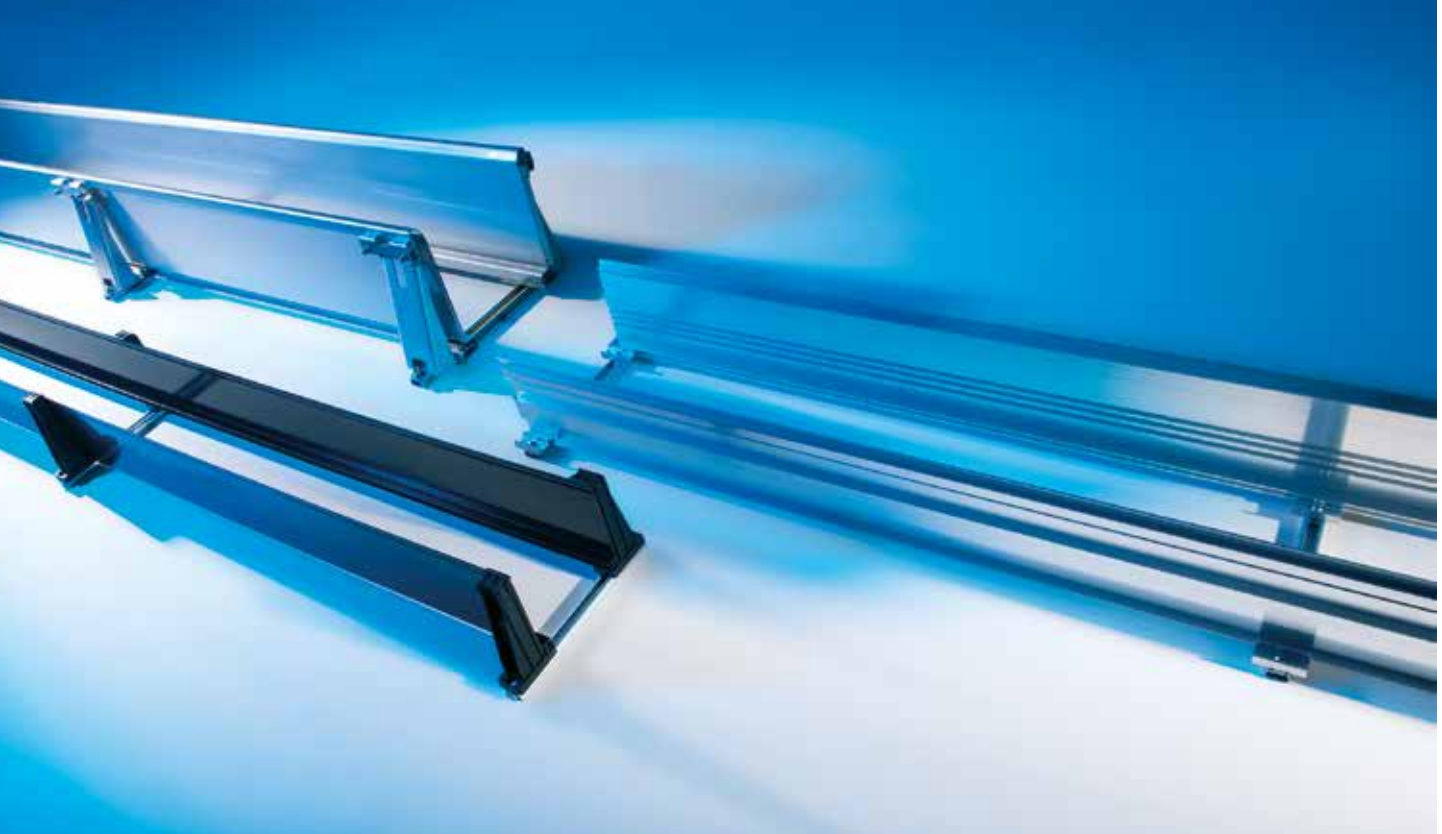

VAW GUIDE CHANNELS - FOR MAXIMUM SPEED ASSEMBLY

The VAW variable guide channel system is harmonised for Murrplastik cable drag chains. Since different applications require different materials, the guide channels are made of galvanized steel, stainless steel or aluminium. We can also supply V4a models on request for saltwater applications.

No screwing or welding is required for the individual sections in our variable guide channel system. The channel sections are perfectly aligned thanks to special plastic connectors or channel brackets. The floor mounting is made with clamping pieces and C-rails.

The glide rail profile not only guarantees snag-free gliding for the cable drag chain over the entire travel distance, but also reduces the noise level.



- Quick and easy assembly
- High quality
- Highly economical
- Tailored system
- Long service life

CONFECTIONING CONNECT 4 MOTION



www.mp.de



EVERYTHING FROM ONE SOURCE

Reduce your labour costs and save time by taking advantage of our experience in chain systems gained over many years.

At the customer's request we assemble complete cable drag chains with cables. We handle the layout, assembly and ordering of individual components. The customer is supplied with a complete assembly kit that only needs to be fitted.

Thanks to our experience of cable drag chains and cables acquired over many years, we can combine both elements in one system. This guarantees a long service life.



- System guarantee
- Easy handling
- Saves time and hassle when ordering
- Reduced warehousing costs

ATEX CABLE DRAG CHAINS

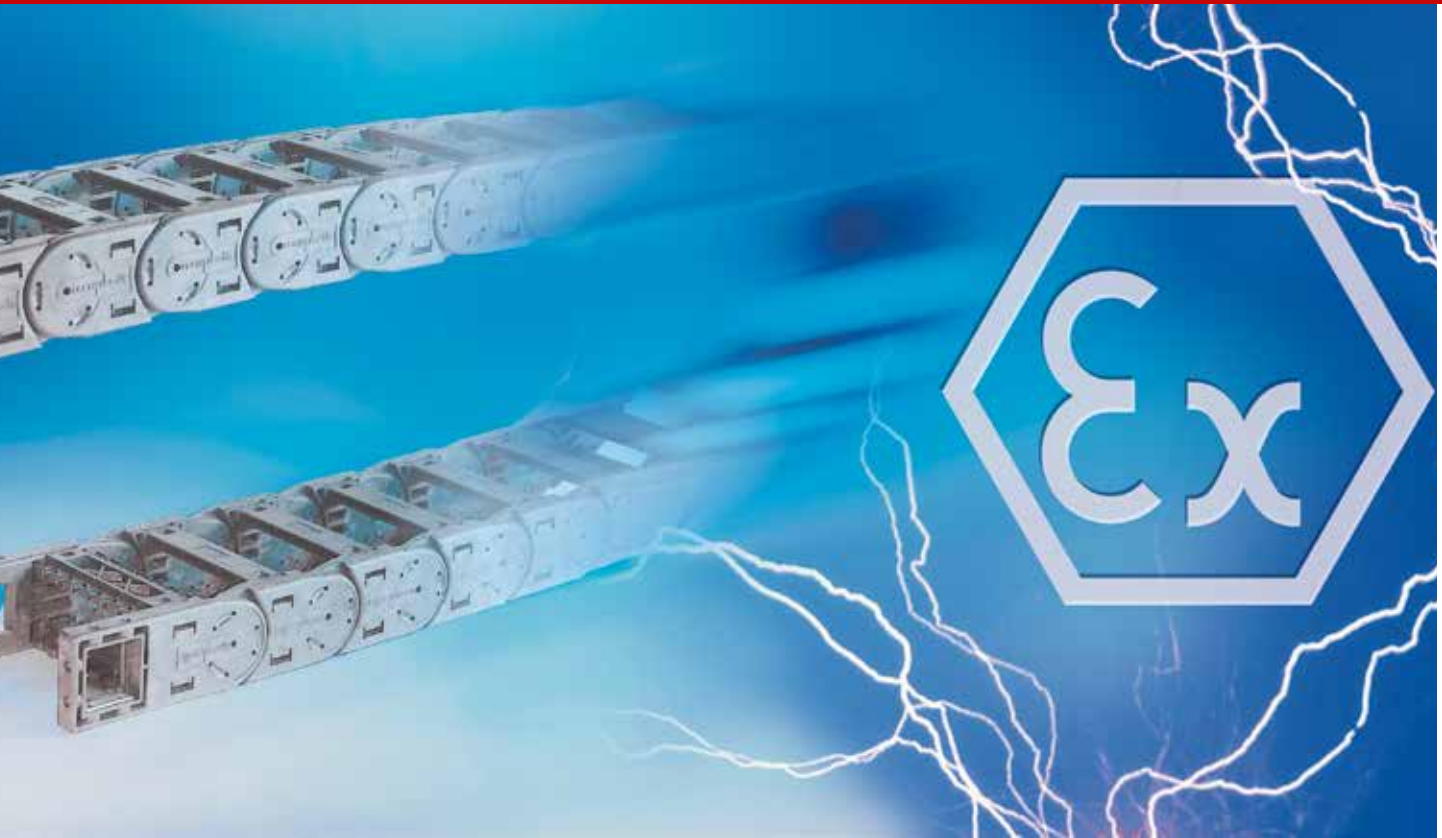

SAFETY ACCORDING TO ATEX EX II 2GD

Since July 2003, all equipment, components and protective systems used in explosion hazard areas must comply with the ATEX Product Directive 94/P/EC.

Explosions can always occur where flammable gases, vapors, liquids or dusts are produced, stored or transported and, under certain conditions, can form an explosive mixture in conjunction with air. In such explosive atmospheres a small spark is often enough to trigger an explosion.

Our certified cable drag chains made of dissipative ESD material always put you on the safe side!



- Full ATEX EX II 2GD certification
- Simple to exchange, certification remains in force
- For areas at risk of explosion 1, 2, 21, 22



ELECTROSTATIC DISCHARGES

In many areas of industrial production, the requirements for avoiding electrostatic discharge are growing in order to protect sensitive electronic components.

Friction occurs between machine parts during movement, which can lead to the formation of frictional electricity. Electrostatic discharges that occur after contact with an earthed body can be harmful to sensitive electronic components: They can be destroyed or their function can be affected.

Murrplastik cable drag chains made of ESD material control and permanently dissipate electrostatic charges.



- **Controlled and permanent discharge of electrostatic discharges**
- **Excellent protection of electronic components**
- **Cable drag chains made of ESD material**

CLEAN ROOM CABLE DRAG CHAINS



APPLICATION IN SENSITIVE CLEAN ENVIRONMENTS

Clean room cable drag chains from Murrplastik Systemtechnik are produced using special materials. These cable drag chains have excellent clean room properties that meet the highest technical requirements.

Even in continuous operation, our clean room cable drag chains discharge only a minimal amount of particles into the environment.

The clean room certification was carried out and confirmed by the renowned Fraunhofer Institute for Manufacturing Engineering and Automation IPA.

Despite its outstanding abrasion properties, Murrplastik nevertheless refused to compromise in the slightest when it comes to functionality, reliability and ease of assembly.



- Clean room classification by Fraunhofer Institute (IPA)
- Fulfills the ATEX Europe guidelines
- Uncompromising functionality
- Unflinching reliability

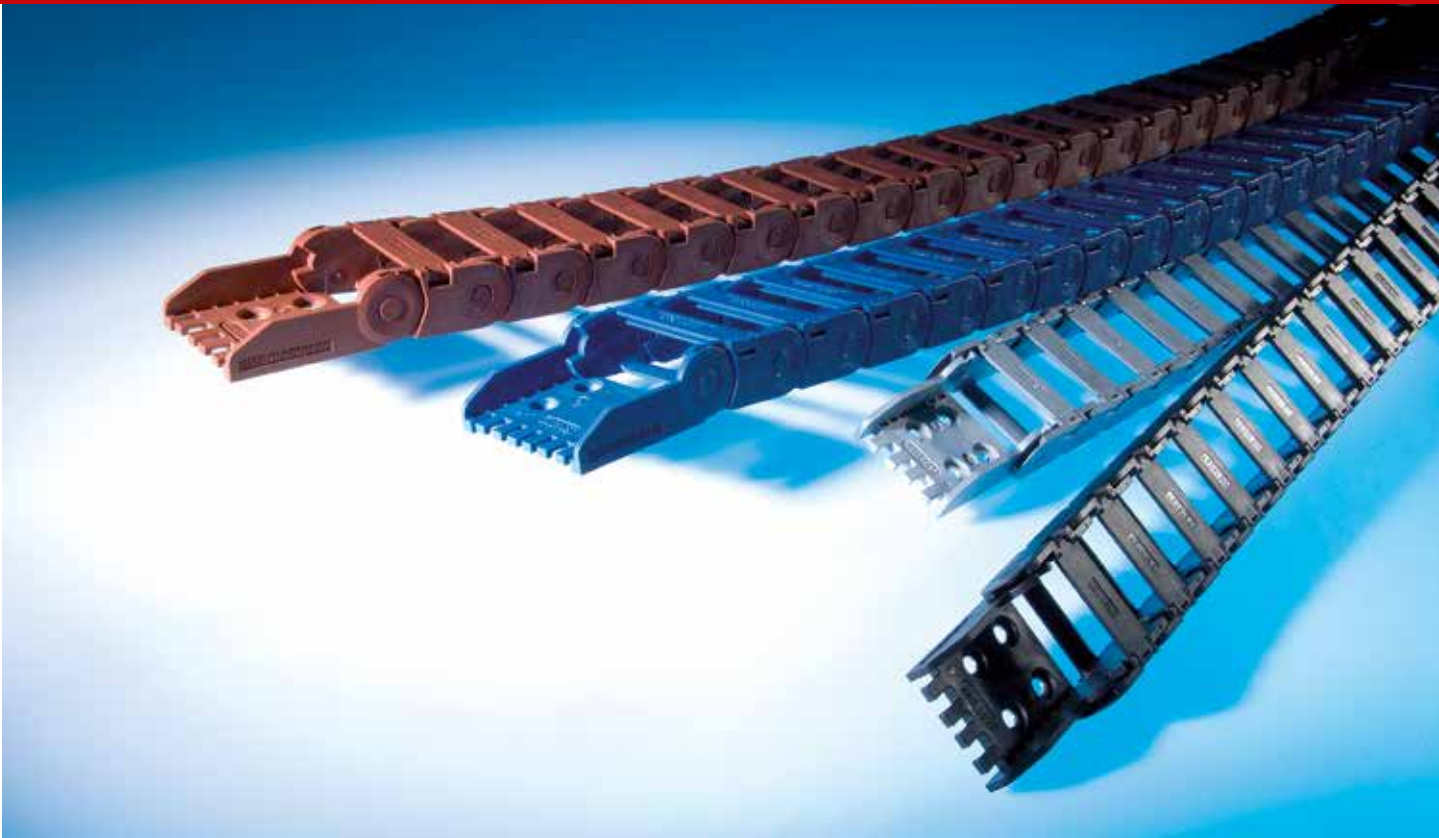

EXTREME AREAS OF APPLICATION REQUIRE DIFFERENT MATERIALS.

The Murrplastik colour coding system enables you to recognise and classify different materials and hence areas of application safely and easily.

Clear assignments, safe use – as with all Murrplastik products.



- Murrplastik colour coding system
- Black cable drag chain:
Polyamide (PA): standard
- Light gray cable drag chain:
Polyamide (PA): EMC model
- Oxide red cable drag chain:
Polyamide (PA), UL 94/V0
- Blue cable drag chain:
Polypropylene (PP)

CORPORATE IDENTITY – INDIVIDUAL CABLE DRAG CHAIN IDENTIFICATION



INDIVIDUAL CABLE DRAG CHAIN IDENTIFICATION

Would you like to individually label your products and stand out from other companies? Should your corporate identity immediately catch the eye?

With our ability to realize locking mechanisms in custom colours and the option to add your company logo, you can set visual signals and accents and give your product a unique identity.

Either access our standard colour palette or ask us for individual solutions.



- Individual product identification
- Locking mechanisms in custom colours
- Addition of company logo on request

SELECTION CRITERIA FOR CABLE DRAG CHAINS

IDEALLY, THE DESIGN OF AN CABLE DRAG CHAIN SYSTEM WILL TAKE THE FOLLOWING CRITERIA INTO ACCOUNT:

- Determine the number and outside diameter of the cables or conduits to be laid.
- For self-supporting applications, the diagram “self-supporting length” can be used to identify the matching chain using load and travel distance.
- Determine width of cable drag chain, design shelving system (separators, shelves, etc.).
- Determine the minimum possible bending radius of cabling and conduits, as per manufacturer specifications, and select the matching bending radius for the cable drag chain.
- Determine chain length respective to the travel distance and the selected bending radius. (Using a formula – see matching cable drag chain types)
- Check whether a guide channel is required for the application. For gliding applications, a guide channel is always required.

SELF-SUPPORTING LENGTHS AND TRAVEL DISTANCES

If the travel distance is too long for self-supporting installation, the chain upper run rests on the chain lower run (the upper run glides over the lower run). We describe this system as a “gliding” type of installation.

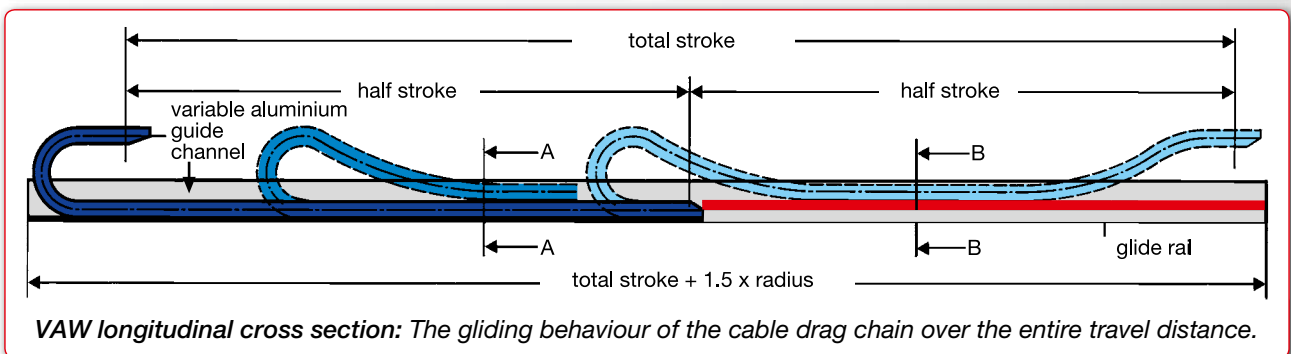
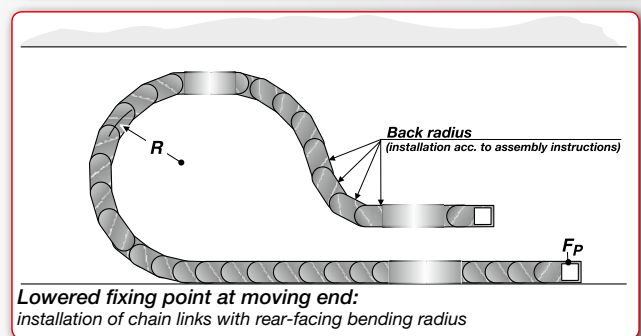
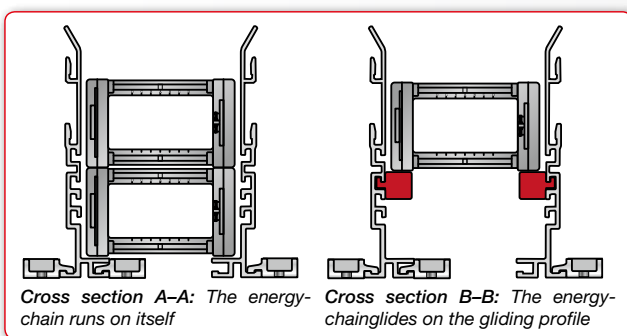

With gliding installations, we recommend setting the chain bracket at the moving end lower, depending on the chain type and bending radius.

Please contact us: we will be very happy to help you design your cable drag chain project. Further information can be found in the “Manual for the design and assembly of cable drag chain systems”, Order No. 8902804550 as well as in our online configuration <https://mymppchain.com/>



		Inside height in mm		Chain type		INSIDE WIDTH		BENDING RADIUS	
		Open	Closed	Crossbars in inch from - to PA ALU		Crossbars in inch from - to PA ALU		Bending radii in inch, from - to	
MURRPLASTIK SERIES	10	MP 10.1		0.24 – 1.61	—	—	—	0.71 – 2.28	
	14	MP 14		0.63 – 1.57	—	—	—	0.98 – 2.95	
	14	MP 15		0.63 – 1.57	—	—	—	0.98 – 2.95	
	18	MP 18.1/.2		0.59 – 2.76	—	—	—	1.10 – 3.07	
	18	MP 18.4		0.71 – 1.97	—	—	—	1.57 – 3.15	
	20	MP 20.2		0.59 – 1.97	—	—	—	1.50 – 4.92	
	25	MP 25.1/.2	25.3/25.4	1.57 – 7.87	—	1.57 – 7.87	—	1.97 – 11.81/3.94 – 11.81*	
	25		MP 25 G	—	—	2.10 – 4.92	—	2.36 – 9.84	
	26	MP 3000		2.10 – 4.92	—	—	—	1.97 – 11.81	
	30	MP 30.1/.2	30.3/.4	1.57 – 7.87	—	1.57 – 7.87	—	2.36 – 11.81/3.94 – 11.81*	
	32/30	MP 32.2	MP 32.3 ALU	1.77 – 21.50	2.64 – 23.62	1.77 – 21.50	1.69 – 23.62	3.15 – 9.84/3.15 – 4.72*	
	35	MP 35.1/.2		1.97 – 6.89	—	—	—	2.48 – 4.72	
	36		MP 36 G	—	—	2.44 – 4.92	—	3.15 – 7.87	
	38		MP 43 G	—	—	2.44 – 7.17	—	4.92 – 15.75	
	42/38	MP 41.2	MP 41.3	1.77 – 21.50	2.64 – 23.62	3.31 – 9.69	1.69 – 23.62	3.54 – 13.78/5.91 – 13.78*	
	45	MP 45.1/.2		1.97 – 6.89	—	—	—	2.95 – 11.81	
	52/48	MP 52.2	MP 52.3	1.77 – 21.50	2.64 – 23.62	3.78 – 13.62	1.69 – 23.62	3.94 – 13.78/5.91 – 13.78*	
	52/48	MP 52.2-D	MP 52.3-D	1.77 – 21.50	2.64 – 23.62	3.78 – 13.62	1.69 – 23.62	7.87	
	52/48	MP 52.4	MP 52.5	1.77 – 21.50	2.64 – 23.62	3.78 – 13.62	1.69 – 23.62	4.92 – 11.81/11.97 – 11.81*	
	52/48	MP 52.6	MP 52.7 ALU	—	1.97 – 23.62	—	1.65 – 23.62	11.97 – 11.81	
60		MP 65 G	—	—	3.31 – 5.67	—	7.87 – 15.75		
62/62	MP 62.2	MP 62.3	3.66 – 20.39	2.83 – 23.62	4.65 – 16.45	1.57 – 23.62	5.91 – 19.69/7.87 – 19.69*		
62	MP 62.4	MP 62.5 ALU	1.77 – 21.50	2.64 – 23.62	—	1.69 – 23.62	5.31 – 11.81/11.97 – 11.81*		
82/74	MP 82.2	MP 82.3	3.66 – 20.39	2.83 – 23.62	9.57	1.57 – 23.62	5.91 – 25.59/7.87 – 25.59*		
102	MP 102.2		3.66 – 20.39	2.83 – 23.62	—	—	9.84 – 19.69		
MURRPLASTIK LEGACY PRODUCTS (do not use for new-build projects)	32	MP 32		1.77 – 21.50	2.64 – 23.62	—	—	3.15 – 9.84	
	34	MP 35		2.44 – 5.91	—	—	—	2.76 – 11.81	
	40	MP 44		1.77 – 7.17	—	—	—	3.54 – 15.75	
	42	MP 41		1.77 – 21.50	2.64 – 23.62	—	—	3.54 – 13.78	
	52	MP 52.1		1.77 – 21.50	2.64 – 23.62	3.15 – 23.62	—	3.94 – 13.78	
	60	MP 66		1.77 – 7.17	3.03 – 23.62	—	—	5.91 – 15.75	
	62	MP 62.1		3.66 – 20.39	2.83 – 23.62	—	—	5.91 – 19.69	
	72	MP 72		3.66 – 20.39	2.83 – 23.62	4.65 – 23.62	—	5.91 – 19.69	

* Note: only for closed variants











		TRAVEL DISTANCE		SPEED		ACCELERATION		
								
		max. travel distance in feet self-supporting gliding applic.		Max. speed of travel in ft/s self-supporting gliding applic.		max. acceleration in ft/s ² self-supporting gliding applic.		
		3.28	32.81	13.12	6.56	6.56	6.56	62
		6.56	39.37	13.12	6.56	6.56	6.56	68
		6.56	39.37	13.12	6.56	6.56	6.56	74
		9.84	65.62	16.40	6.56	16.40	16.40	80
		9.84	65.62	16.40	6.56	16.40	16.40	86
		9.84	not recommended	32.81	–	32.81	–	92
		13.12	114.83	32.81	9.84	49.21	32.81	162
		13.12	131.23	19.69	9.84	49.21	32.81	106
		13.12	196.85	19.69	9.84	49.21	32.81	98
		14.76	131.23	32.81	9.84	49.21	32.81	174
		14.76	328.08	65.62	16.40	98.43	82.02	186
		19.68	262.46	65.62	16.40	164.04	49.21	114
		13.12	196.85	32.81	9.84	65.62	49.21	126
		16.40	164.04	49.21	16.40	65.62	49.21	134
		22.97	165.62	65.62	16.40	98.43	82.02	202
		22.97	262.46	32.81	16.40	65.62	49.21	142
		29.53	492.12	65.62	16.40	98.43	82.02	218
		29.53	492.12	65.62	16.40	98.43	82.02	234
		24.61	164.04	65.62	16.40	98.43	82.02	250
		–	492.12	–	19.69	–	32.81	266
		26.25	196.85	49.21	16.40	65.62	49.21	154
		32.81	492.12	65.62	16.40	131.23	82.02	290
		24.61	164.04	65.62	16.40	98.43	82.02	276
		32.81	492.12	65.62	16.40	131.23	82.02	304
		34.45	492.12	65.62	16.40	131.23	82.02	318
		16.40	328.08	65.62	16.40	98.43	82.02	330
		14.76	262.46	32.81	9.84	65.62	49.21	344
		16.40	164.04	49.21	16.40	65.62	49.21	366
		22.97	165.62	65.62	16.40	98.43	82.02	352
		29.53	492.12	65.62	16.40	98.43	82.02	374
		26.25	196.85	49.21	16.40	65.62	49.21	400
		32.81	492.12	65.62	16.40	131.23	82.02	388
		32.81	492.12	65.62	16.40	131.23	82.02	408

Catalogue page



SELECTION TABLE CONFIGURATION

	Inside height in mm	Chain type		CHAIN BRACKET							STRAIN RELIEF	
		Open	Closed	U-part (plastic)	U-part (steel)	Flexible	Angle	Flange	integrated	integrated (RS-ZL)	integrated (bow clamp)	separately mountable (ZL)
MURRPLASTIK SERIES	10	MP 10.1		•					•			
	14	MP 14		•					•			
	14	MP 15		•					•			
	18	MP 18.1/2		•					•			
	18	MP 18.4		•					•			
	20	MP 20.2		•					•			
	25	MP 25.1/2	25.3/25.4			•				•	•	
	25		MP 25 G		•							•
	26	MP 3000		•			•		•			•
	30	MP 30.1/2	30.3/4			•				•	•	
	32/30	MP 32.2	MP 32.3 ALU			•				•	•	
	35	MP 35.1/2				•				•	•	
	36		MP 36 G		•			•				•
	38		MP 43 G				•					•
	42/38	MP 41.2	MP 41.3			•	•			•	•	
	45	MP 45.1/2				•				•	•	
	52/48	MP 52.2	MP 52.3			•	•			•	•	
	52/48	MP 52.2-D	MP 52.3-D			•	•			•	•	
	52/48	MP 52.4	MP 52.5			•				•	•	
	52/48	MP 52.6	MP 52.7 ALU			•					•	
60		MP 65 G		•		•	•					
62/62	MP 62.2	MP 62.3			•	•			•	•		
62	MP 62.4	MP 62.5 ALU			•				•	•		
82/74	MP 82.2	MP 82.3			•				•	•		
102	MP 102.2					•			•	•		
MURRPLASTIK LEGACY PRODUCTS <i>(do not use for new-build projects)</i>	32	MP 32				•				•	•	
	34	MP 35			•		•					•
	40	MP 44			•		•					•
	42	MP 41				•	•			•	•	
	52	MP 52.1				•	•			•	•	
	60	MP 66			•		•	•				
	62	MP 62.1				•	•			•	•	
	72	MP 72				•	•			•	•	

				ACCESSORIES				SHELVING SYSTEM							
				Sliding blocks (GS)	Damping elements for the side links	Gliding plates (GLP)	Bracket bars (BS)	Separator with snap-lock (TR/TRT)	Separator (TR-V)	Separator fixed	Shelving system (RTT)	Shelving system	Crossbar connector (RSY)	H-shaped shelf unit (RE)	Catalogue page
															
															62
															68
															74
															80
															86
															92
															162
															106
															98
															174
															186
															114
															126
															134
															202
															142
															218
															234
															250
															266
															154
															290
															276
															304
															318
															330
															344
															366
															352
															374
															400
															388
															408

	Inside height in mm	Chain type	OPENING VARIANTS									Catalogue page		
			No opening	Slitted	Inside bend foldable on one side*	Outside bend foldable on one side*	Inside bend foldable on both sides*	Outside bend foldable on both sides*	Inside and outside bend engage seamlessly	Inside and outside bend engage				
	Open	Closed	1	2	3	4	5	6	7	8	9			
MURRPLASTIK SERIES	10	MP 10.1		•								62		
	14	MP 14				•						68		
	14	MP 15		•								74		
	18	MP 18.1/2			•	•						80		
	18	MP 18.4		•								86		
	20	MP 20.2			•							92		
	25	MP 25.1/2	25.3/25.4					•	•				162	
	25		MP 25 G				•						106	
	26	MP 3000						•					98	
	30	MP 30.1/2	30.3/4					•	•				174	
	32/30	MP 32.2	MP 32.3 ALU									•	186	
	35	MP 35.1/2						•	•				114	
	36		MP 36 G			•							126	
	38		MP 43 G								•		134	
	42/38	MP 41.2	MP 41.3									•	202	
	45	MP 45.1/2						•	•				142	
	52/48	MP 52.2	MP 52.3									•	218	
	52/48	MP 52.2-D	MP 52.3-D									•	234	
	52/48	MP 52.4	MP 52.5									•	250	
	52/48	MP 52.6	MP 52.7 ALU									•	266	
60		MP 65 G								•		154		
62/62	MP 62.2	MP 62.3									•	290		
62	MP 62.4	MP 62.5 ALU									•	276		
82/74	MP 82.2	MP 82.3									•	304		
102	MP 102.2										•	318		
MURRPLASTIK LEGACY PRODUCTS <i>(do not use for new-build projects)</i>	32	MP 32								•		330		
	34	MP 35							•			344		
	40	MP 44								•		366		
	42	MP 41								•		352		
	52	MP 52.1								•		374		
	60	MP 66								•		400		
	62	MP 62.1								•		388		
	72	MP 72								•		408		

* Note: not recommended for gliding applications

SELECTION TABLE AVAILABLE MATERIAL / RECOMMENDED GUIDE CHANNELS



	Inside height in mm	Chain type		MATERIAL				GUIDE CHANNEL								
		Open	Closed	Standard	ESD/ATEX/Clean room	PA black	PA gray	Fireprotected UL94V0	H2O environment	PA red	PP blue	rcmd - aluminium guide channel (for self-supporting application)	rcmd - aluminium guide channel (for gliding application)	rcmd - stainless steel* guide channel (for self-supporting application)	rcmd - stainless steel* guide channel (for gliding application)	Catalogue page
								VAW	VAW	VAW-E	VAW-E					
MURRPLASTIK SERIES	10	MP 10.1		•	•	•		25	80	—	—	62				
	14	MP 14		•				25	80	—	—	68				
	14	MP 15		•	•	•		25	80	—	—	74				
	18	MP 18.1/2		•	•	•	•	35	80	—	—	80				
	18	MP 18.4		•				35	80	—	—	86				
	20	MP 20.2		•				35	80	—	—	92				
	25	MP 25.1/2	25.3/25.4	•				80	86	120	120	162				
	25		MP 25 G	•	•			80	86	120	120	106				
	26	MP 3000		•	•	•	•	80	86	120	120	98				
	30	MP 30.1/2	30.3/4	•				80	86	120	120	174				
	32/30	MP 32.2	MP 32.3 ALU	•	•		•	86	106	120	120	186				
	35	MP 35.1/2		•				80	86	120	120	114				
	36		MP 36 G	•				80	86	120	120	126				
	38		MP 43 G	•				86	106	120	120	134				
	42/38	MP 41.2	MP 41.3	•	•		•	86	122	120	120	202				
	45	MP 45.1/2		•				86	106	120	120	142				
	52/48	MP 52.2	MP 52.3	•	•		•	86	146	120	170	218				
	52/48	MP 52.2-D	MP 52.3-D	•	•		•	86	146	120	170	234				
	52/48	MP 52.4	MP 52.5	•				86	146	120	170	250				
	52/48	MP 52.6	MP 52.7 ALU	•				—	146	—	170	266				
60		MP 65 G	•				86	146	120	170	154					
62/62	MP 62.2	MP 62.3	•	•		•	106	177	120	170	290					
62	MP 62.4	MP 62.5 ALU	•				106	146	120	170	276					
82/74	MP 82.2	MP 82.3	•	•		•	146	248	170	220	304					
102	MP 102.2		•				146	248	170		318					
MURRPLASTIK LEGACY PRODUCTS <i>(do not use for new-build projects)</i>	32	MP 32		•				86	106	120	120	330				
	34	MP 35		•				80	86	120	120	344				
	40	MP 44		•				86	106	120	120	366				
	42	MP 41		•				86	106	120	120	352				
	52	MP 52.1		•				86	146	120	170	374				
	60	MP 66		•				86	146	120	170	400				
	62	MP 62.1		•				106	177	120	170	388				
	72	MP 72		•				122	177	120	170	408				

* Note: also available in steel

Installation options for cable drag chains

	<p>1 Horizontal installation option, self-supporting</p>		<p>7 Horizontal installation option, parallel</p>
	<p>2 Horizontal installation option, gliding</p>		<p>8 Horizontal installation option, opposed</p>
	<p>3 Horizontal installation option, self-supporting, overlap with support</p>		<p>9 Vertical installation option, standing</p>
	<p>4 Horizontal installation option, circular movement Design using reverse bending radius</p>		<p>10 Vertical installation option, hanging</p>
	<p>5 Horizontal installation option, side-mounted (rotated 90°)</p>		<p>11 Horizontal/vertical combined installation option</p>
	<p>6 Horizontal installation option, side-mounted (rotated 90°) with support</p>		<p>12 Horizontal installation option, interlocked</p>

Quotation Order Date:

Project designation:		Project implementation in week/year:
Customer No.:	Customer information:	Planning extent:
Company:		<input type="checkbox"/> Cable drag chain (CDC)
Department:		<input type="checkbox"/> Guide channel
Contact person:		<input type="checkbox"/> Tubes
Address/PO Box:		<input type="checkbox"/> Cables
Address/PO Box:		<input type="checkbox"/> Wire connection
Phone and extension no.:		<input type="checkbox"/> Complete assembly
Fax and extension no.:		<input type="checkbox"/> MP on-site assembly service
E-mail address:		

Application parameters:

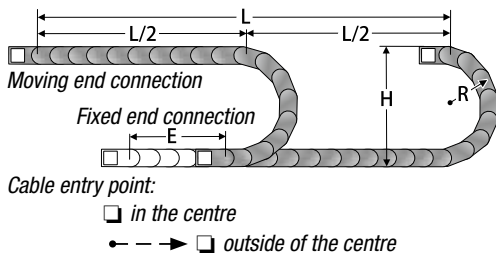

Please select type of installation:

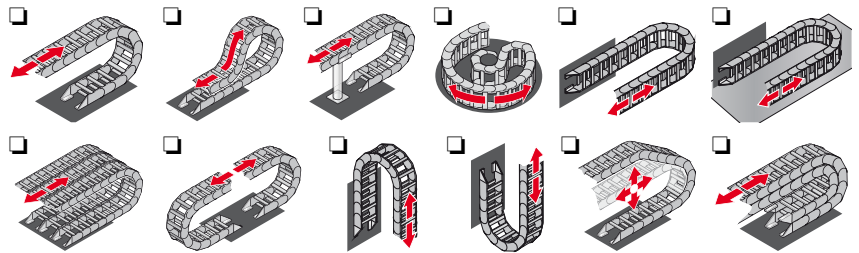

CDC type (also competitors):		Quantity of CDC:	Units
CDC length (if predefined):	mm inch	Quantity of links:	Units
Travel distance (L):	mm inch	Min. bending radius (R):	ft (mm)
Maximum installation height (H):	mm inch	Max. installation width:	ft (mm)
Speed of travel:	m/s ft/s	Material:	<input type="checkbox"/> PA (Standard)
Acceleration:	m/s ² ft/s ²		<input type="checkbox"/> PA UL V0
Travel frequency:	cycles/day cycles/day		<input type="checkbox"/> PA ESD
Load:	kg/m lbs/ft		<input type="checkbox"/> PP
Ambient temperature (from - to):	°C °F		
Environmental influences:	<input type="checkbox"/> Outdoor application <input type="checkbox"/> Dirt <input type="checkbox"/> Swarf <input type="checkbox"/> Dust <input type="checkbox"/>		
Feed-in (cable entry point):	<input type="checkbox"/> Centre of travel dist. <input type="checkbox"/> Ends of travel distance		
Dist. E between entry point and middle of travel dist.:	mm from the centre of the travel distance		

1. Inside/Down 2. Inside/Up 3. Outside/down 4. Outside/up 5. Front/Inside 6. Front/outside 7. Flex/bush 8. Flex/thread

Chain bracket

Fixed end connection - no.:

Moving end connection - no.:

9. U-part/below 10. U-part/above 11. Up 90° 12. Down 90°

<p>Case example: KA/F with C-profile and Steel Fix bow clamps</p>	<p>Strain relief</p> <p><input type="checkbox"/> Crossbar strain relief plate (type RS-ZL with standard inside widths up to 9.69 in (246 mm))</p> <p><input type="checkbox"/> Strain relief plates (type ZL for strain relief outside of the chain bracket)</p> <p><input type="checkbox"/> C-profile including strain relief plate (type ZL-C Set)</p> <p><input type="checkbox"/> C-profile</p> <p><input type="checkbox"/> Steel Fix bow clamps Type: <input type="text"/></p> <p><input type="checkbox"/> on both sides</p>	<p>Case example: KA/F with crossbar strain relief plate RS-ZL</p>
---	---	---

Cut out and fax/copy

Project designation:	Project implementation in week/year:
-----------------------------	---

Opening variant cable drag chain (loading side)	<input type="checkbox"/> inside bend	<input type="checkbox"/> outside bend
	<input type="checkbox"/> on both sides	

Variable guide channel system		
<input type="checkbox"/> Murrplastik quotation requested		Material: <input type="checkbox"/> Plastic <input type="checkbox"/> Aluminium <input type="checkbox"/> Stainless steel <input type="checkbox"/> Steel (zinc-plated)
<input type="checkbox"/> Guide channel existing / dimensions		Additional foreign components:
Internal width of the guide channel:	ft (mm)	
Internal height of the guide channel:	ft (mm)	
Distance of bearing profiles:	ft (mm)	

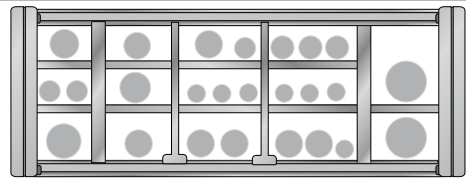
Partitioning the energy carriers (cables, tubes) into the internal chain compartment	
<input type="checkbox"/> Chain compartment is supposed to be designed by Murrplastik <input type="checkbox"/> Assignment according to Murrplastik cable request form <input type="checkbox"/> Murrplastik is supposed to be supply cables, details in MP cable request form <input type="checkbox"/> Chain compartment according to customer request (see sketch below) <input type="checkbox"/> Cables provided by customer (remark outside diameters below)	 <p style="text-align: center;"><i>Example: Multi-layer internal chain compartment</i></p>

Sketches, notes, specific features:

Quotation Order Date:

Project designation:		Project implementation in week/year:
Customer No.:	Customer information:	
Company:		
Department:		
Contact person:		
Address/PO Box:		
Address/PO Box:		
Phone and extension no.:		
Fax and extension no.:		
E-mail address:		

Environmental conditions of the cable drag chain application – required for the choice of cable types					
Bending radius:	inch	mm	<input type="checkbox"/> Oil-resistant		
Travel distance:	inch	mm	<input type="checkbox"/> UV resistant/outdoor application		
minimum temperature:	°F	°C	<input type="checkbox"/> UL/CSA authorisation requested (operation in the US/Canada)*		
maximum temperature:	°F	°C	* low stock, low options, long delivery times and minimum order quantity applicable		
Speed of travel:	ft/s	m/s	<input type="checkbox"/> corresponding drawing / data for wire connection attached		
Other:			<input type="checkbox"/> customisation: see MP wire connection form		

CDC assignment		<i>** cables without customisation are cut to total length only per cable one wire connection form is to be attached</i>					
Pos. No.	Cables/Conduits Description, number of wires, cross sections, reference type, item No.. etc.	External ø in mm	Shielding requested?	Customisation requested? ** (separate form)	Total-length in ft / in m	Overlap at fixed point in ft / in m	Overlap at moving point in ft / in m
			<input type="checkbox"/> yes	<input type="checkbox"/> yes			
			<input type="checkbox"/> yes	<input type="checkbox"/> yes			
			<input type="checkbox"/> yes	<input type="checkbox"/> yes			
			<input type="checkbox"/> yes	<input type="checkbox"/> yes			
			<input type="checkbox"/> yes	<input type="checkbox"/> yes			
			<input type="checkbox"/> yes	<input type="checkbox"/> yes			
			<input type="checkbox"/> yes	<input type="checkbox"/> yes			
			<input type="checkbox"/> yes	<input type="checkbox"/> yes			
			<input type="checkbox"/> yes	<input type="checkbox"/> yes			
			<input type="checkbox"/> yes	<input type="checkbox"/> yes			
			<input type="checkbox"/> yes	<input type="checkbox"/> yes			
			<input type="checkbox"/> yes	<input type="checkbox"/> yes			
			<input type="checkbox"/> yes	<input type="checkbox"/> yes			
			<input type="checkbox"/> yes	<input type="checkbox"/> yes			
			<input type="checkbox"/> yes	<input type="checkbox"/> yes			
			<input type="checkbox"/> yes	<input type="checkbox"/> yes			
			<input type="checkbox"/> yes	<input type="checkbox"/> yes			
			<input type="checkbox"/> yes	<input type="checkbox"/> yes			
			<input type="checkbox"/> yes	<input type="checkbox"/> yes			
			<input type="checkbox"/> yes	<input type="checkbox"/> yes			
			<input type="checkbox"/> yes	<input type="checkbox"/> yes			
			<input type="checkbox"/> yes	<input type="checkbox"/> yes			
			<input type="checkbox"/> yes	<input type="checkbox"/> yes			
			<input type="checkbox"/> yes	<input type="checkbox"/> yes			
			<input type="checkbox"/> yes	<input type="checkbox"/> yes			
			<input type="checkbox"/> yes	<input type="checkbox"/> yes			
			<input type="checkbox"/> yes	<input type="checkbox"/> yes			

Cables with green-yellow protective conductor (PE) are standard (exception: bus and data cables up to 0.75mm²).
 Cables with PE are often also marked with G, e.g. 3G1.5 means two normal conductors and 1 PE with a cross section of 1.5mm² each.
 Please identify cables without protective/ground conductor (PE)!

Cut out and fax/copy



Project designation:		
Position within CDC cable request form no.:		Features:
Cable reference type:		<input type="checkbox"/> No shielding
Conduit construction/design:		<input type="checkbox"/> shielded (see below: <i>Shield processing</i>)
Contact person:		<input type="checkbox"/> Cable without protective conductor PE
<p>Cables with green-yellow protective conductor (PE) are standard (exception: bus and data cables up to 0.75 mm²). Cables with PE are often also marked with G, e.g. 3G1.5 means two normal conductors and 1 PE with a cross section of 1.5mm² each.</p>		

Customisation of cable endings

FP aspect (fixed point connection)	MP aspect (moving point connection)
<input type="checkbox"/> Ending not processed – cable cut to total length only	<input type="checkbox"/> Ending not processed – cable cut to total length only

alternatively:

alternatively:

<input type="checkbox"/> Ending with connector		<input type="checkbox"/> Ending with connector	
Item No. of connector		Item No. of connector	
Description, supplier:		Description, supplier:	
Connections (quantity of contacts):		Connections (quantity of contacts):	
<input type="checkbox"/> Male connector		<input type="checkbox"/> Male connector	
<input type="checkbox"/> Female connector		<input type="checkbox"/> Female connector	
Item No. of contact:		Item No. of contact:	
Housing for connector:		Housing for connector:	
Item No. / design:		Item No. / design:	
Cable outlet on housing:	<input type="checkbox"/> straight <input type="checkbox"/> sideways	Cable outlet on housing:	<input type="checkbox"/> straight <input type="checkbox"/> sideways
Cable compression gland (type):		Cable compression gland (type):	

Wiring specifications

- Pin assignment: see enclosed plan or chart
 - Standard wiring as extension cord (pin 1 to 1, 2 to 2 etc.)
- When used as an extension the connectors are wired from pin 1. If there are not enough wires, the high contact pins will be unconnected.

alternatively:

alternatively:

<input type="checkbox"/> End processed (without housing)		<input type="checkbox"/> End processed (without housing)	
bared cable length (jacket free):		bared cable length (jacket free):	
Wire end ferrule:		Wire end ferrule:	
Contacts:		Contacts:	
Ring-type cable lugs:		Ring-type cable lugs:	
	(Type, supplier, item No., size, which wire?)		(Type, supplier, item No., size, which wire?)

<input type="checkbox"/> Shield processing	Entire shield	if nec. pair(s) of wire(s)	<input type="checkbox"/> Shield processing	Entire shield	if nec. pair(s) of wire(s)
cut:			cut:		
on housing:			on housing:		
shield connected to pin No.:			shield connected to pin No.:		
extended with wire/length:		ft mm	extended with wire/length:		ft mm
shield bent back on jacket:			shield bent back on jacket:		

<input type="checkbox"/> Labelling	Short text:	<input type="checkbox"/> Labelling	Short text:
<input type="checkbox"/> label cable jacket (sticker, ESL):		<input type="checkbox"/> label cable jacket (sticker, ESL):	
<input type="checkbox"/> label single wire(s) (e.g. KDE):		<input type="checkbox"/> label single wire(s) (e.g. KDE):	
Distance from jacket/cable end:	ft mm	Distance from jacket/cable end:	ft mm

Additional text for labelling: see attached circuit diagram:

Notes (attachments etc.):

Murrplastik Glossary – So that you know what we are talking about

We want to make our products and product components as accessible to you as possible. So what, then, are the actual names Murrplastik uses for specific components?

You'll find the answers in this Glossary. We have prepared some schematic drawings of sub-assemblies and individual components for you with the terms that we use for them.

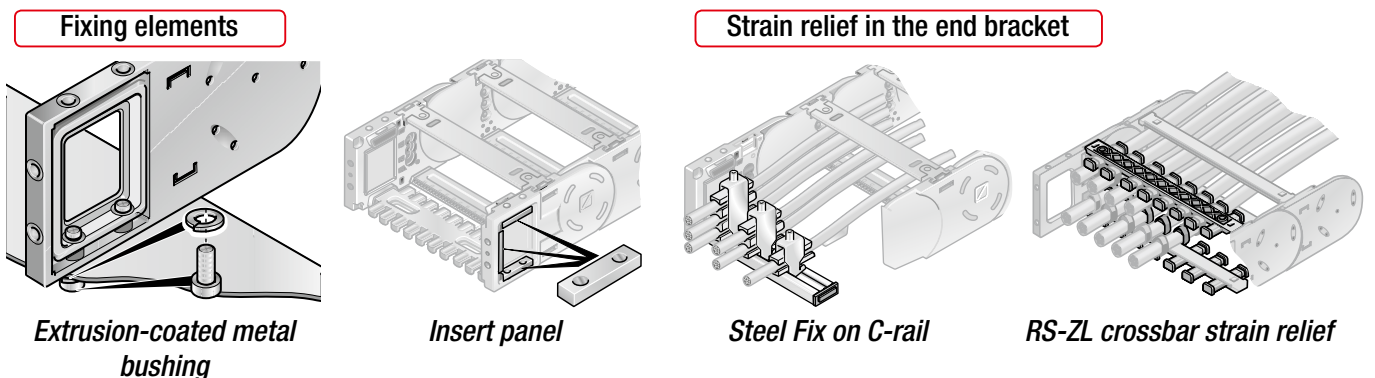
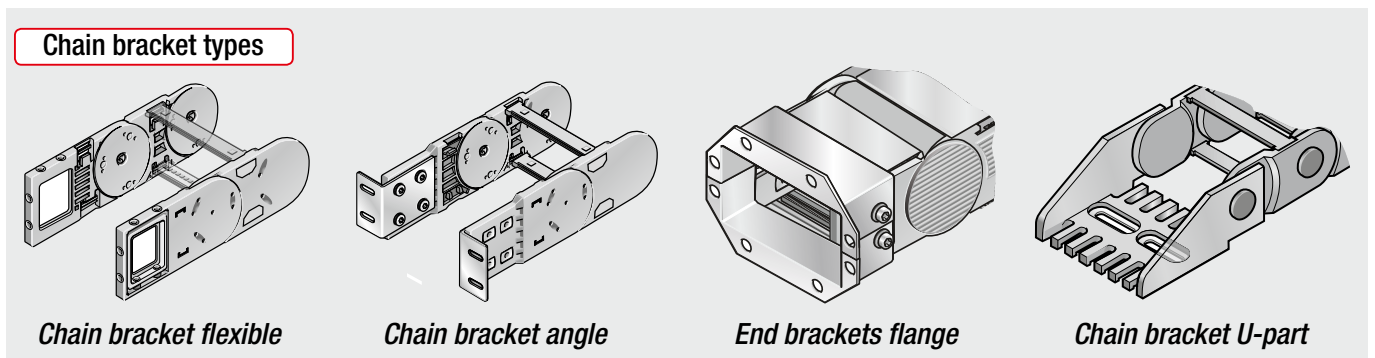
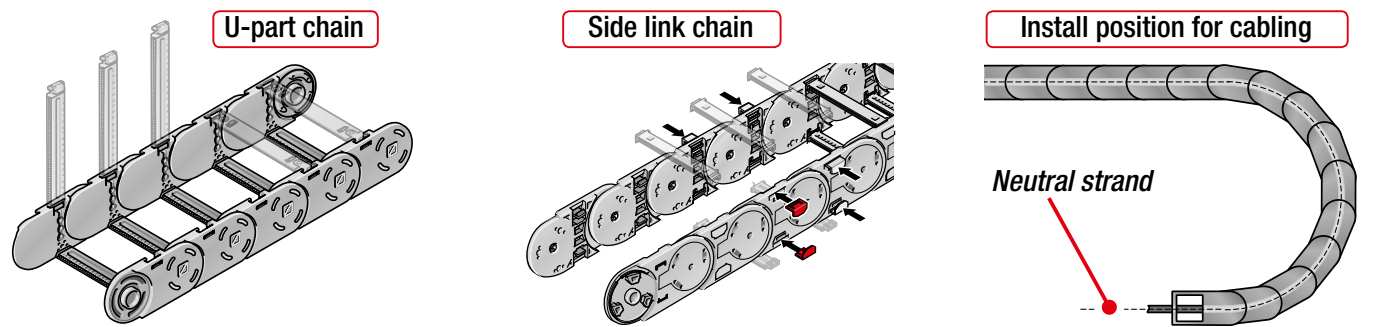
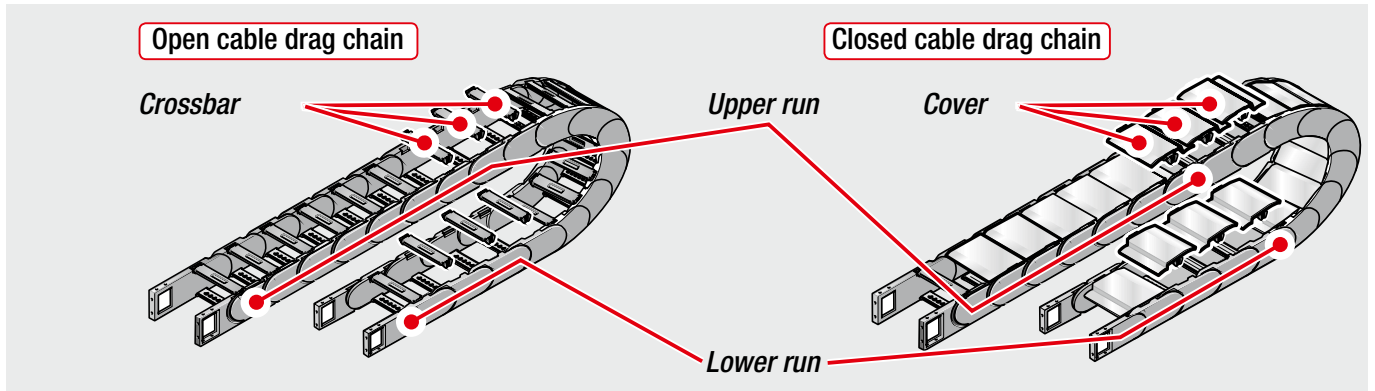

Murrplastik Glossary – So that you know what we are talking about

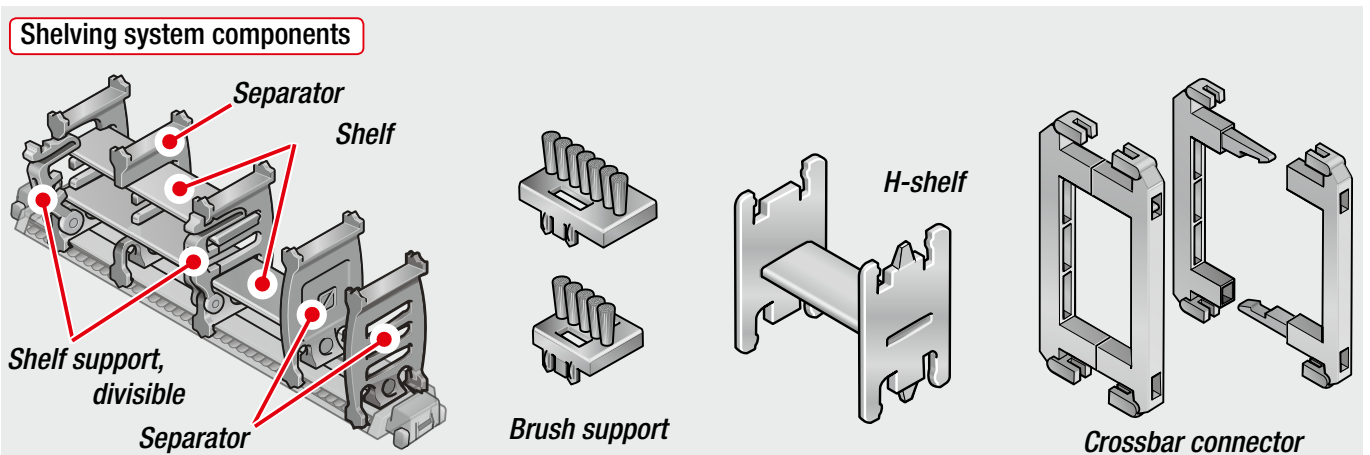
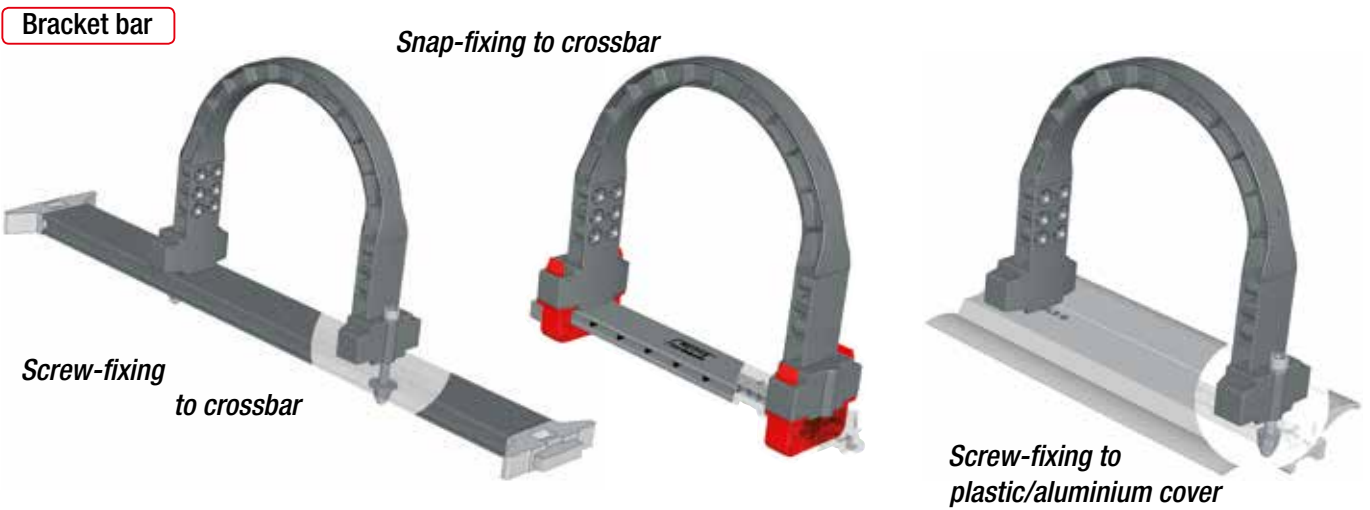
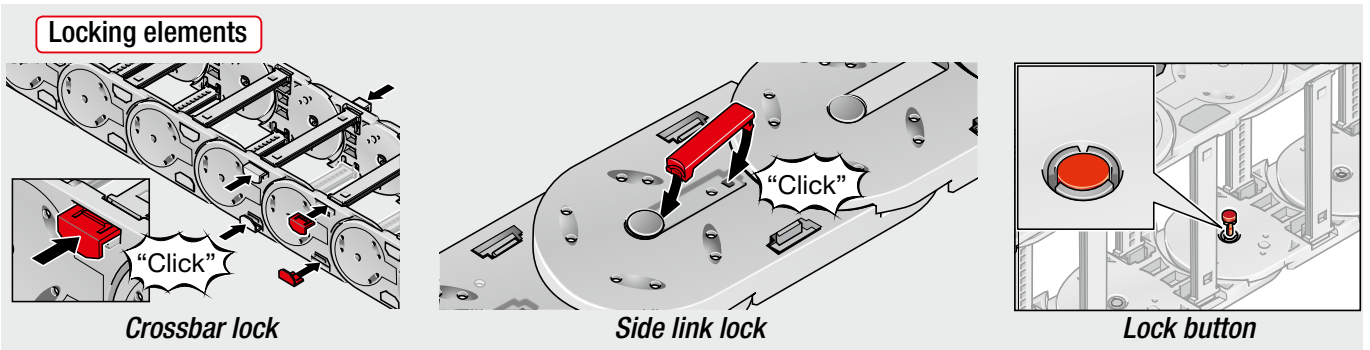
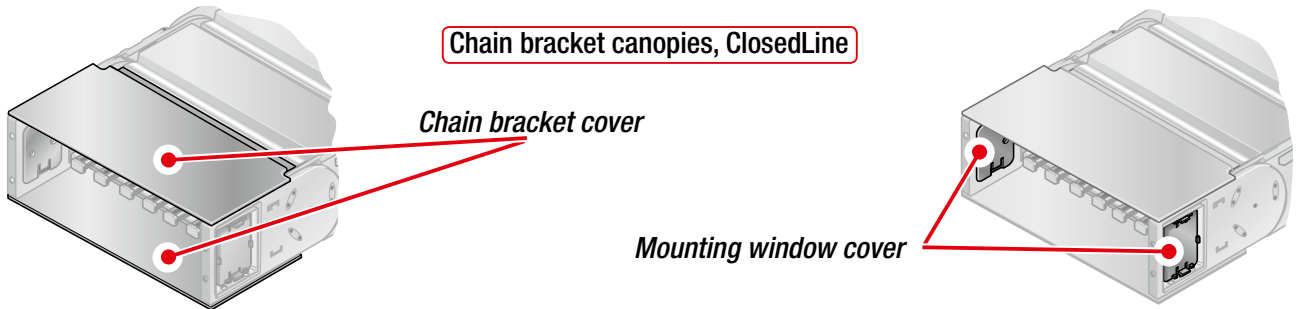

Murrplastik Glossary – So that you know what we are talking about

Our guide channel systems and their accessory parts are also given specific names. So what, then, are the names Murrplastik uses for specific components?

You'll find the answers in this Glossary. We have prepared some schematic drawings of sub-assemblies and individual components for you with the terms that we use for them.

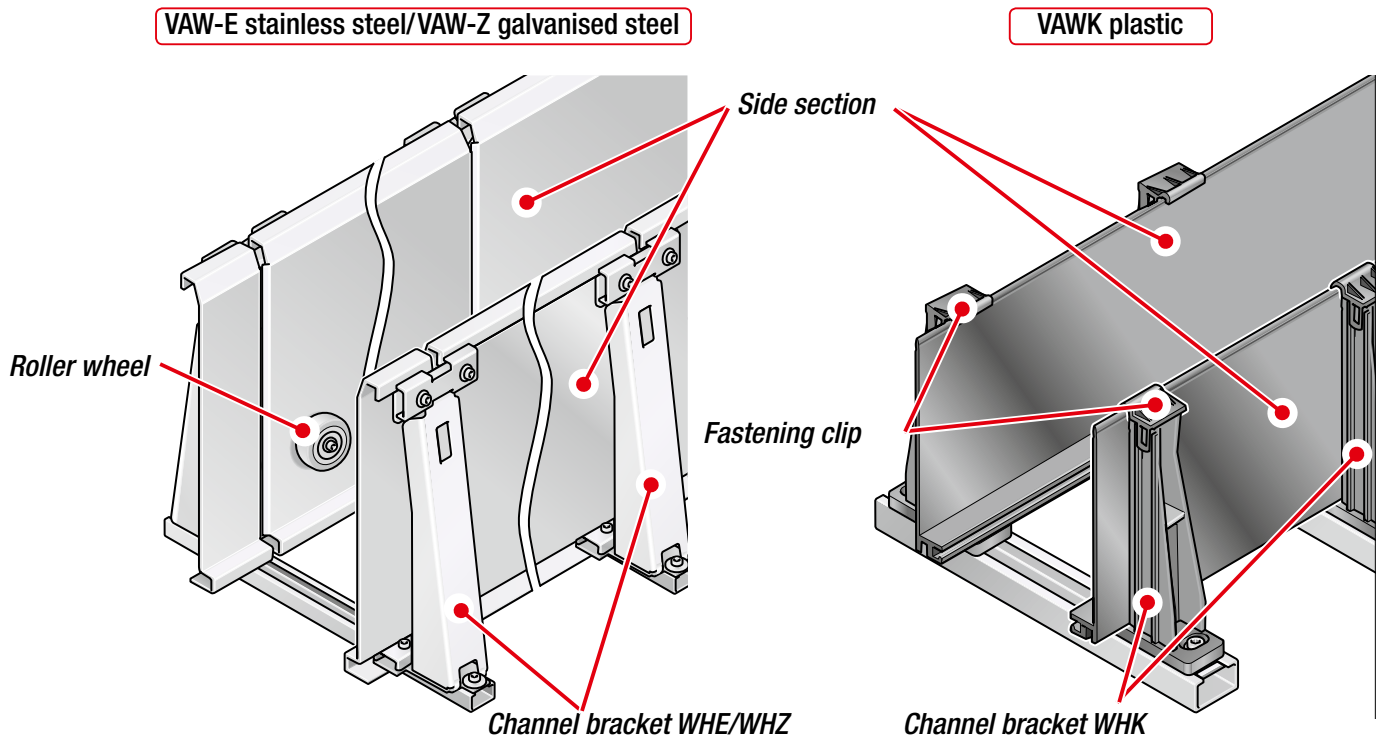
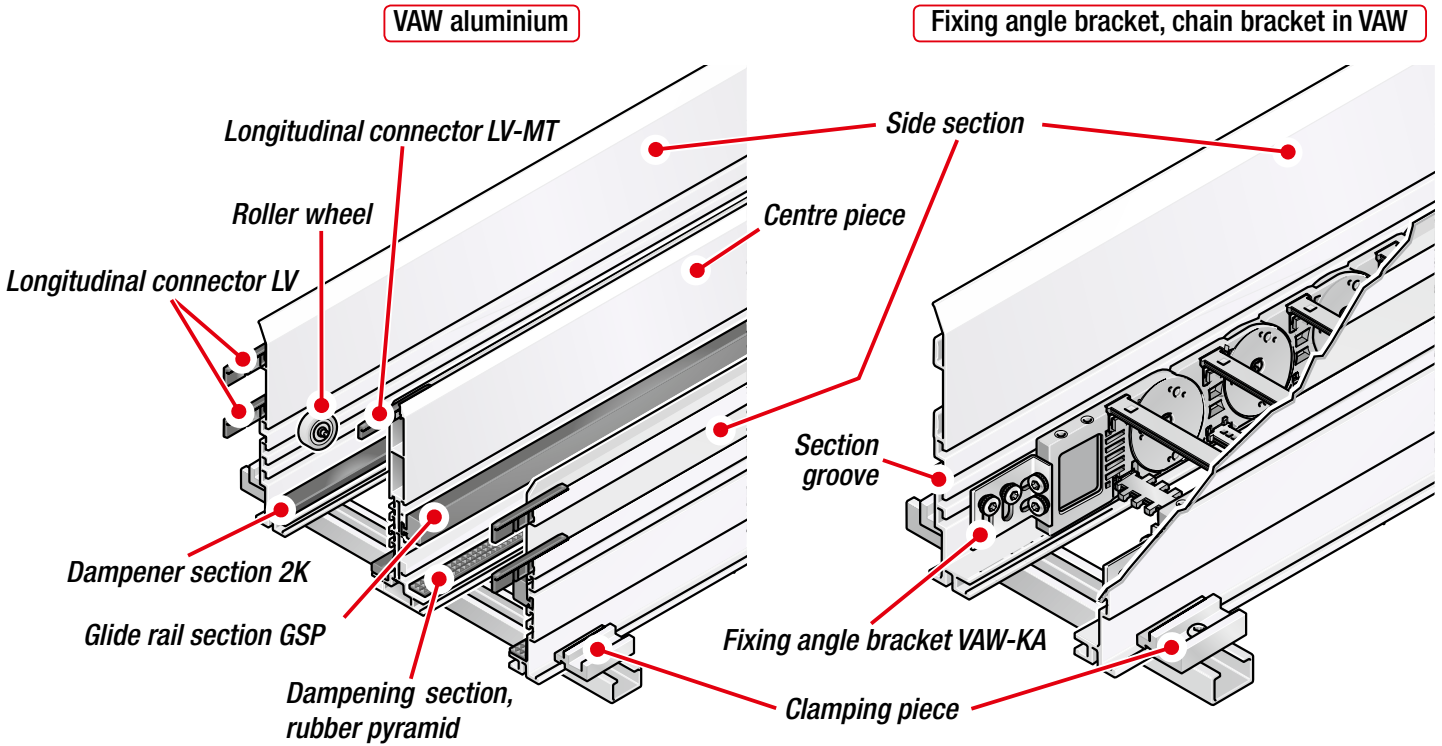

**EasyLine
MP 10.1**

open
Page 62

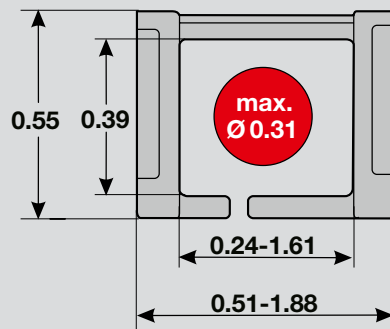

- Internal height: 0.39 inch
- Internal widths: 0.24 – 1.61 inch
- Radii: 0.71 – 2.28 inch
- Grid: 0.59 inch
- Links per foot: 21 qty.
- Loading side: Outside bend slitted

**MultiLine
MP 14**

open
Page 68

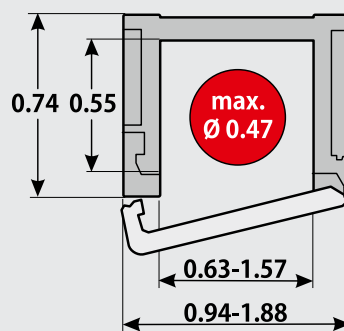

- Internal height: 0.55 inch
- Internal widths: 0.63 – 1.57 inch
- Radii: 0.98 – 2.95 inch
- Grid: 1.02 inch
- Links per foot: 12 qty.
- Loading side: Outside bend

**MultiLine
MP 15**

open
Page 74

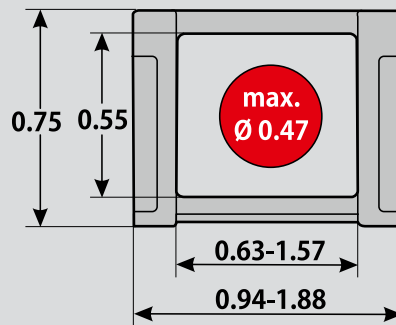

- Internal height: 0.55 inch
- Internal widths: 0.63 – 1.57 inch
- Radii: 0.98 – 2.95 inch
- Grid: 1.02 inch
- Links per foot: 12 qty.
- Loading side: Non-opening

**MultiLine
MP 18.1
MP 18.2**

**open
open**
Page 80

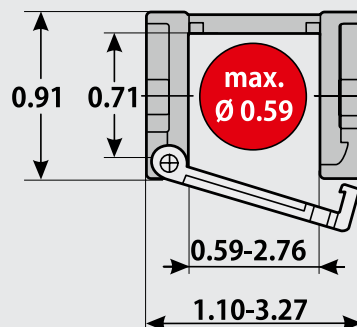

- Internal height: 0.71 inch
- Internal widths: 0.59 – 2.76 inch
- Radii: 1.1 – 3.07 inch
- Grid: 1.30 inch
- Links per foot: 10 qty.
- Loading side: Inside or outside bend

- Travel distance gliding L_g max.: 32.81 ft.
- Travel distance self-supporting L_f max.: see diagram on page 65
- Travel distance vertical, hanging L_{vh} max.: 6.56 ft.
- Travel distance vertical, upright L_{vs} max.: 3.28 ft.
- Rotated 90°, unsupported L_{90f} max.: not recommended
- Speed, gliding V_g max.: 6.56 ft/s
- Speed, self-supporting V_f max.: 13.12 ft/s
- Acceleration, gliding a_g max.: 6.56 ft/s²
- Acceleration, self-supporting a_f max.: 6.56 ft/s²

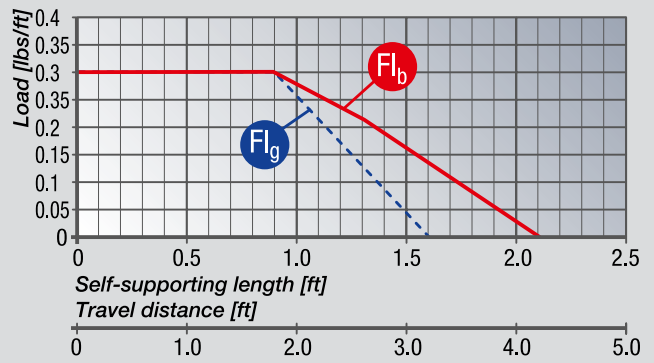

- Travel distance gliding L_g max.: 39.37 ft.
- Travel distance self-supporting L_f max.: see diagram on page 71
- Travel distance vertical, hanging L_{vh} max.: 9.84 ft.
- Travel distance vertical, upright L_{vs} max.: 6.56 ft.
- Rotated 90°, unsupported L_{90f} max.: not recommended
- Speed, gliding V_g max.: 6.56 ft/s
- Speed, self-supporting V_f max.: 13.12 ft/s
- Acceleration, gliding a_g max.: 6.56 ft/s²
- Acceleration, self-supporting a_f max.: 6.56 ft/s²

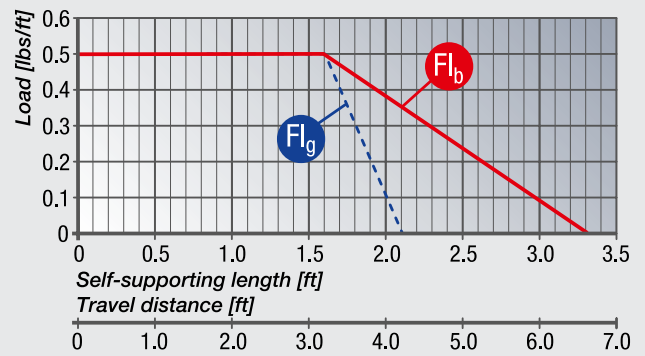

- Travel distance gliding L_g max.: 39.37 ft.
- Travel distance self-supporting L_f max.: see diagram on page 77
- Travel distance vertical, hanging L_{vh} max.: 9.84 ft.
- Travel distance vertical, upright L_{vs} max.: 6.56 ft.
- Rotated 90°, unsupported L_{90f} max.: not recommended
- Speed, gliding V_g max.: 6.56 ft/s
- Speed, self-supporting V_f max.: 13.12 ft/s
- Acceleration, gliding a_g max.: 6.56 ft/s²
- Acceleration, self-supporting a_f max.: 6.56 ft/s²

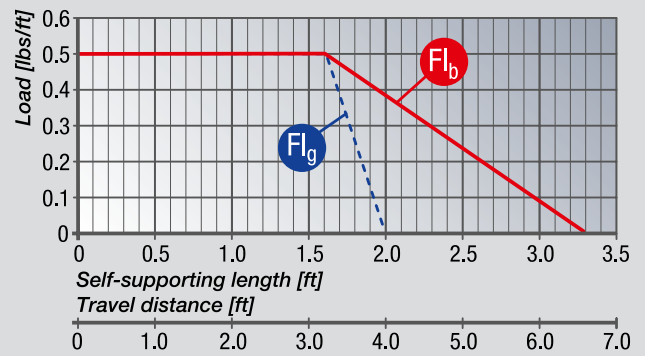

- Travel distance gliding L_g max.: 65.62 ft.
- Travel distance self-supporting L_f max.: see diagram on page 83
- Travel distance vertical, hanging L_{vh} max.: 26.25 ft.
- Travel distance vertical, upright L_{vs} max.: 9.84 ft.
- Rotated 90°, unsupported L_{90f} max.: 1.64 ft.
- Speed, gliding V_g max.: 6.56 ft/s
- Speed, self-supporting V_f max.: 16.40 ft/s
- Acceleration, gliding a_g max.: 16.40 ft/s²
- Acceleration, self-supporting a_f max.: 16.40 ft/s²

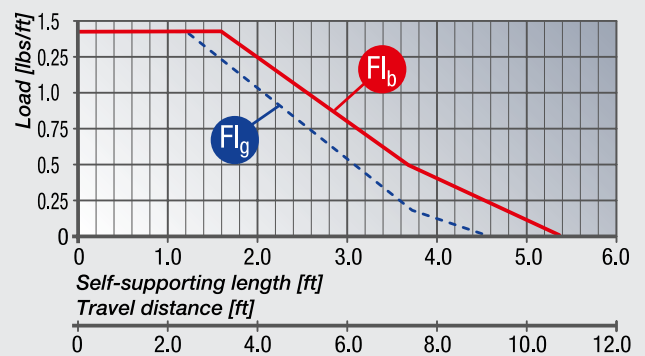

**MultiLine
MP 18.4**

open
Page 86

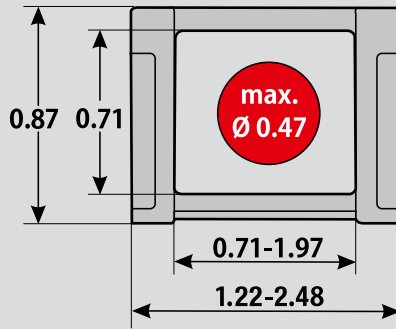

- Internal height: 0.71 inch
- Internal widths: 0.71 – 1.97 inch
- Radii: 1.57 – 3.15 inch
- Grid: 1.30 inch
- Links per foot: 11 qty.
- Loading side: Non-opening

**MultiLine
MP 20**

open
Page 92

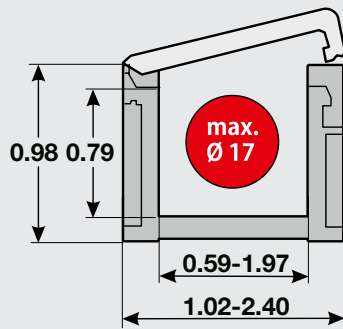

- Internal height: 0.79 inch
- Internal widths: 0.59 – 1.97 inch
- Radii: 1.5 – 4.92 inch
- Grid: 1.38 inch
- Links per foot: 9 qty.
- Loading side: Inside bend

**MultiLine
MP 25G**

closed
Page 106

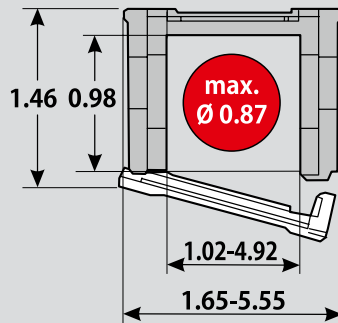

- Internal height: 0.98 inch
- Internal widths: 1.02 – 4.92 inch
- Radii: 2.36 – 9.84 inch
- Grid: 1.18 inch
- Links per foot: 11 qty.
- Loading side: Outside bend

**ModulLine
MP 25.1/.2
MP 25.3/.4**

**open
closed**
Page 162

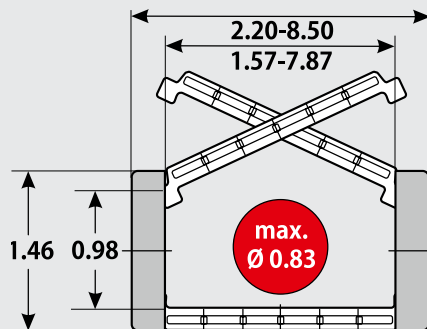

- Internal height: 0.98 inch
- Internal widths: 1.57 – 7.87 inch
- Radii: 1.97 – 11.81 inch
- Grid: 1.77 inch
- Links per foot: 7 qty.
- Loading side: Inside or outside bend

- Travel distance gliding L_g max.: 65.62 ft.
- Travel distance self-supporting L_f max.: see diagram on page 89
- Travel distance vertical, hanging L_{vh} max.: 26.25 ft.
- Travel distance vertical, upright L_{vs} max.: 9.84 ft.
- Rotated 90°, unsupported L_{90f} max.: 1.64 ft.
- Speed, gliding V_g max.: 6.56 ft/s
- Speed, self-supporting V_f max.: 16.40 ft/s
- Acceleration, gliding a_g max.: 16.40 ft/s²
- Acceleration, self-supporting a_f max.: 16.40 ft/s²

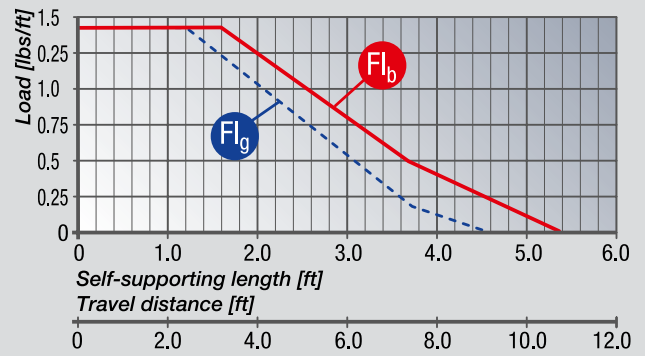

- Travel distance gliding L_g max.: not recommended
- Travel distance self-supporting L_f max.: see diagram on page 95
- Travel distance vertical, hanging L_{vh} max.: 26.25 ft.
- Travel distance vertical, upright L_{vs} max.: 9.84 ft.
- Rotated 90°, unsupported L_{90f} max.: 1.64 ft.
- Speed, self-supporting V_f max.: 32.81 ft/s
- Acceleration, self-supporting a_f max.: 32.81 ft/s²

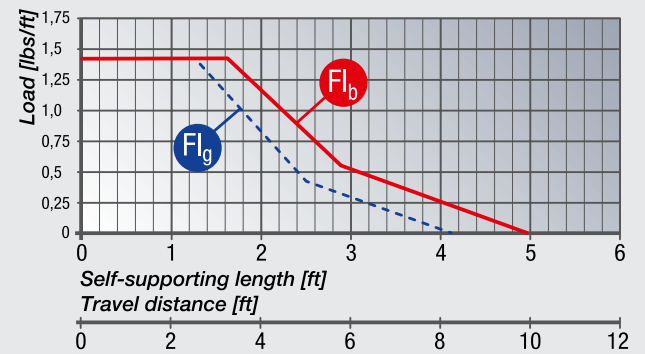

- Travel distance gliding L_g max.: 131.23 ft.
- Travel distance self-supporting L_f max.: see diagram on page 109
- Travel distance vertical, hanging L_{vh} max.: 82.02 ft.
- Travel distance vertical, upright L_{vs} max.: 9.84 ft.
- Rotated 90°, unsupported L_{90f} max.: 3.28 ft.
- Speed, gliding V_g max.: 9.84 ft/s
- Speed, self-supporting V_f max.: 19.69 ft/s
- Acceleration, gliding a_g max.: 32.81 ft/s²
- Acceleration, self-supporting a_f max.: 49.21 ft/s²

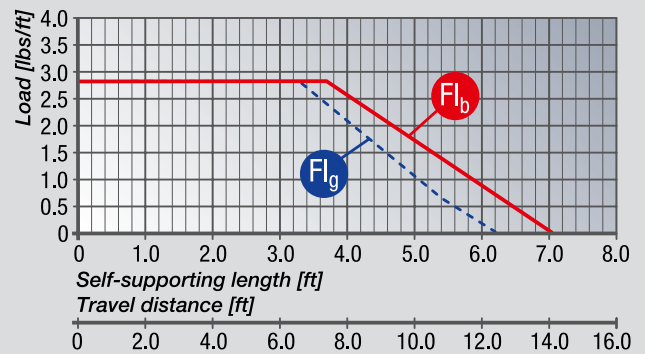

- Travel distance gliding L_g max.: 114.83 ft.
- Travel distance self-supporting L_f max.: see diagram on page 165
- Travel distance vertical, hanging L_{vh} max.: 82.02 ft.
- Travel distance vertical, upright L_{vs} max.: 9.84 ft.
- Rotated 90°, unsupported L_{90f} max.: 2.30 ft.
- Speed, gliding V_g max.: 9.84 ft/s
- Speed, self-supporting V_f max.: 32.81 ft/s
- Acceleration, gliding a_g max.: 32.81 ft/s²
- Acceleration, self-supporting a_f max.: 49.21 ft/s²

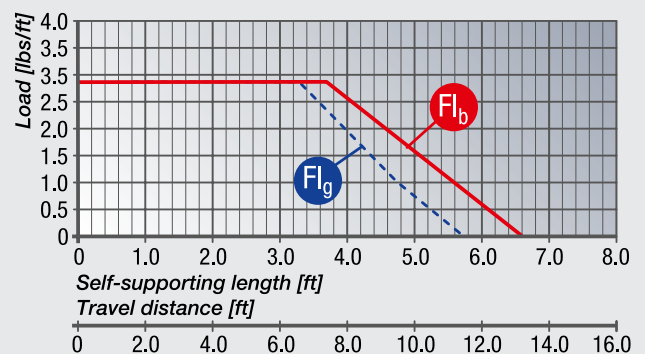

**MultiLine
MP 3000**

open
Page 98

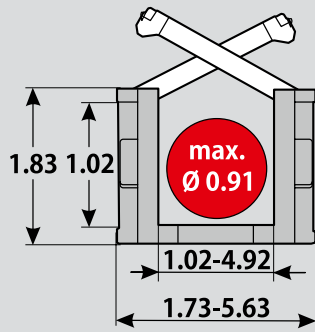

- Internal height: 1.02 inch
- Internal widths: 1.02 – 4.92 inch
- Radii: 1.97 – 11.81 inch
- Grid: 1.77 inch
- Links per foot: 7 qty.
- Loading side: Inside bend

**ModulLine
MP 30.1/.2
MP 30.3/.4**

**open
closed**
Page 174

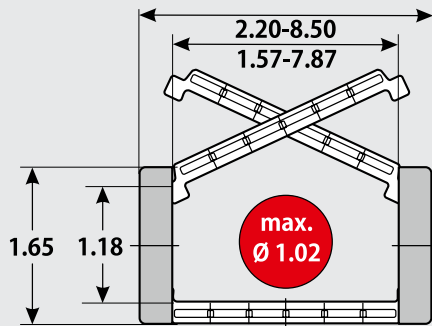

- Internal height: 1.18 inch
- Internal widths: 1.57 – 7.87 inch
- Radii: 2.36 – 11.81 inch
- Grid: 1.97 inch
- Links per foot: 7 qty.
- Loading side: Inside or outside bend

**PowerLine
MP 32.2
MP 32.3**

**open
closed**
Page 186

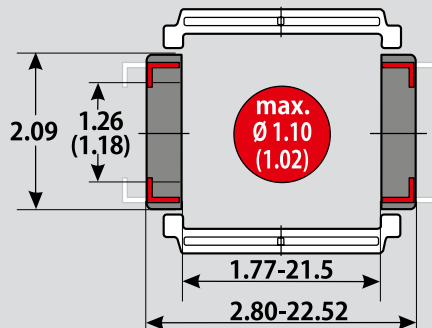

- Internal height: 1.26 inch
- Internal widths: 1.77 – 21.5 inch
- Radii: 3.15 – 9.84 inch
- Grid: 2.54 inch
- Links per foot: 5 qty.
- Loading side: Inside and outside bend
- MP 32.3 inner widths 2.44–13.62 in (62–346 mm), radii 4.72–9.84 in (120–250 mm), lower inner height (values in brackets)

**MP Legacy
MP 32**

open
Page 330

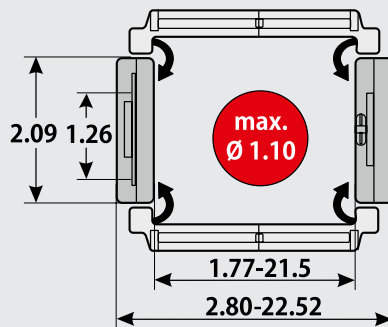

- Internal height: 1.26 inch
- Internal widths: 1.77 – 21.5 inch
- Radii: 3.15 – 9.84 inch
- Grid: 2.54 inch
- Links per foot: 5 qty.
- Loading side: Inside and outside bend

- Travel distance gliding L_g max.: 196.85 ft.
- Travel distance self-supporting L_f max.: see diagram on page 101
- Travel distance vertical, hanging L_{vh} max.: 131.23 ft.
- Travel distance vertical, upright L_{vs} max.: 9.84 ft.
- Rotated 90°, unsupported L_{90f} max.: 2.30 ft.
- Speed, gliding V_g max.: 9.84 ft/s
- Speed, self-supporting V_f max.: 19.69 ft/s
- Acceleration, gliding a_g max.: 32.81 ft/s²
- Acceleration, self-supporting a_f max.: 49.21 ft/s²

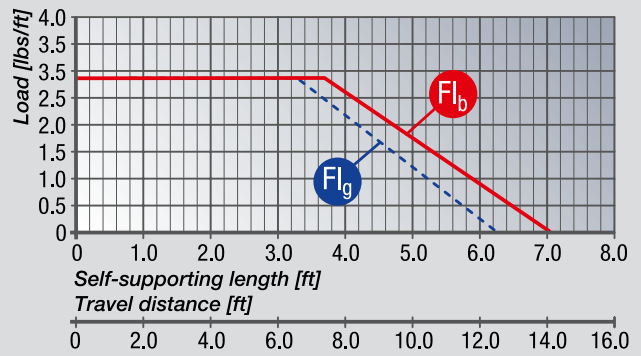

- Travel distance gliding L_g max.: 131.23 ft.
- Travel distance self-supporting L_f max.: see diagram on page 177
- Travel distance vertical, hanging L_{vh} max.: 98.43 ft.
- Travel distance vertical, upright L_{vs} max.: 9.84 ft.
- Rotated 90°, unsupported L_{90f} max.: 2.30 ft.
- Speed, gliding V_g max.: 9.84 ft/s
- Speed, self-supporting V_f max.: 32.81 ft/s
- Acceleration, gliding a_g max.: 32.81 ft/s²
- Acceleration, self-supporting a_f max.: 49.21 ft/s²

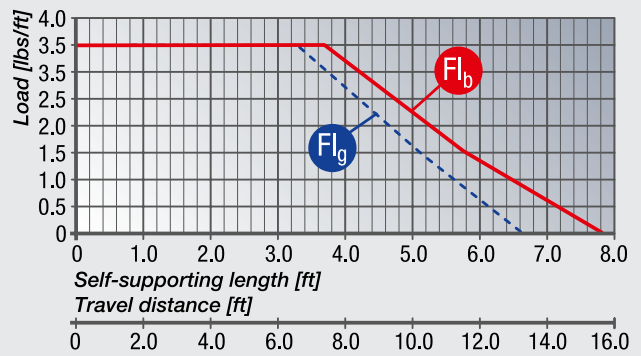

- Travel distance gliding L_g max.: 328.08 ft.
- Travel distance self-supporting L_f max.: see diagram on page 189
- Travel distance vertical, hanging L_{vh} max.: 131.23 ft.
- Travel distance vertical, upright L_{vs} max.: 16.40 ft.
- Rotated 90°, unsupported L_{90f} max.: 3.28 ft.
- Speed, gliding V_g max.: 16.40 ft/s
- Speed, self-supporting V_f max.: 65.62 ft/s
- Acceleration, gliding a_g max.: 82.02 ft/s²
- Acceleration, self-supporting a_f max.: 98.43 ft/s²

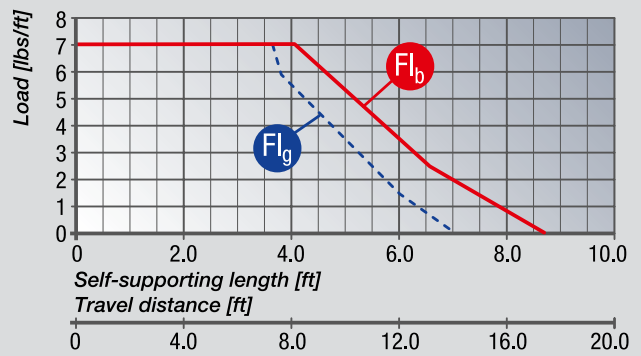

- Travel distance gliding L_g max.: 328.08 ft.
- Travel distance self-supporting L_f max.: see diagram on page 333
- Travel distance vertical, hanging L_{vh} max.: 131.23 ft.
- Travel distance vertical, upright L_{vs} max.: 16.40 ft.
- Rotated 90°, unsupported L_{90f} max.: 6.56 ft.
- Speed, gliding V_g max.: 16.40 ft/s
- Speed, self-supporting V_f max.: 65.62 ft/s
- Acceleration, gliding a_g max.: 82.02 ft/s²
- Acceleration, self-supporting a_f max.: 98.43 ft/s²

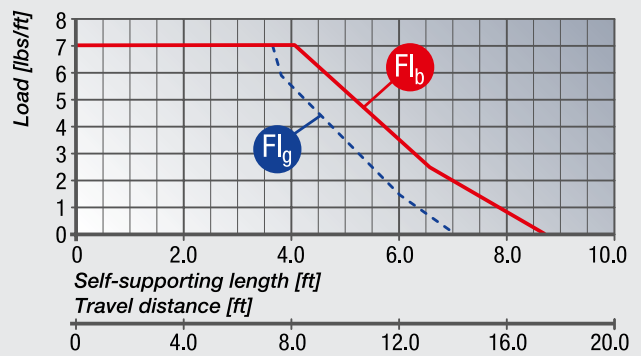

MP Legacy

MP 35

open

Page 344

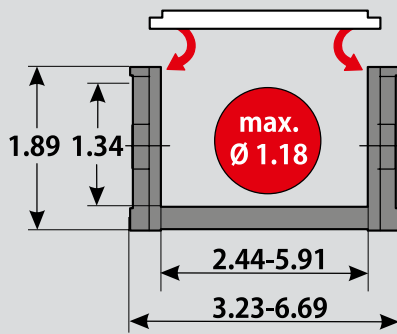

- Internal height: 1.34 inch
- Internal widths: 2.44 – 5.91 inch
- Radii: 2.76 – 11.81 inch
- Grid: 2.28 inch
- Links per foot: 6 qty.
- Loading side: Inside bend

MultiLine

MP 35.1

MP 35.2

open

open

Page 114

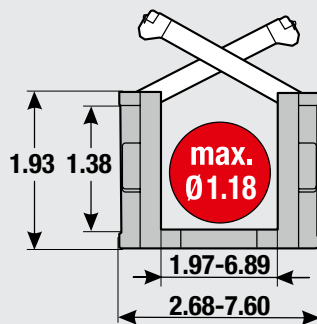

- Internal height: 1.38 inch
- Internal widths: 50.0 – 175.0
- Radii: 63.0 – 250.0
- Grid: 2.20 inch
- Links per foot: 6 qty.
- Loading side: Inside or outside bend

MultiLine

MP 36G

closed

Page 126

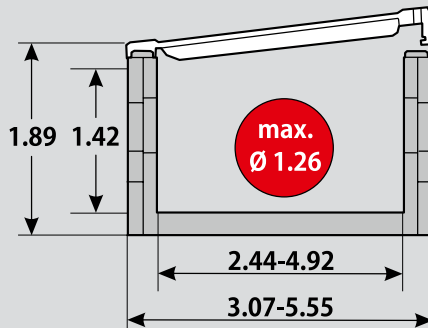

- Internal height: 1.42 inch
- Internal widths: 2.44 – 4.92 inch
- Radii: 3.15 – 7.87 inch
- Grid: 1.57 inch
- Links per foot: 8 qty.
- Loading side: Inside bend

MultiLine

MP 43G

closed

Page 134

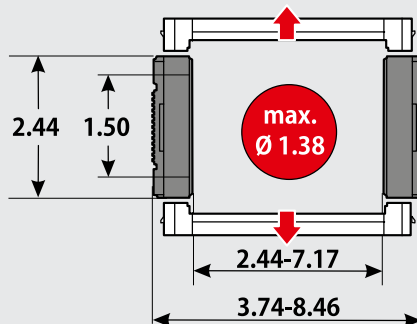

- Internal height: 1.50 inch
- Internal widths: 2.44 – 7.17 inch
- Radii: 4.92 – 15.75 inch
- Grid: 2.97 inch
- Links per foot: 4 qty.
- Loading side: Inside and outside bend

- Travel distance gliding L_g max.: 262.47 ft.
- Travel distance self-supporting L_f max.: see diagram on page 347
- Travel distance vertical, hanging L_{vh} max.: 131.23 ft.
- Travel distance vertical, upright L_{vs} max.: 9.84 ft.
- Rotated 90°, unsupported L_{90f} max.: 3.28 ft.
- Speed, gliding V_g max.: 9.84 ft/s
- Speed, self-supporting V_f max.: 32.81 ft/s
- Acceleration, gliding a_g max.: 49.21 ft/s²
- Acceleration, self-supporting a_f max.: 65.62 ft/s²

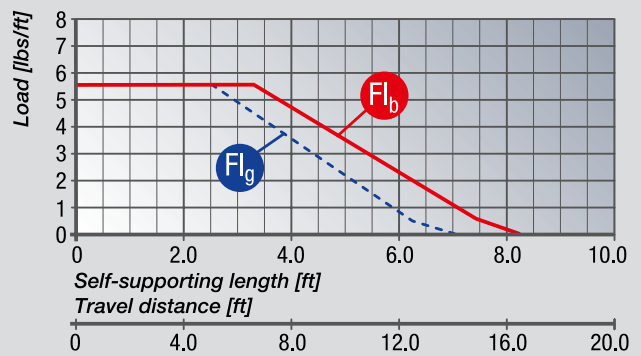

- Travel distance gliding L_g max.: 262.47 ft.
- Travel distance self-supporting L_f max.: see diagram on page 117
- Travel distance vertical, hanging L_{vh} max.: 164.04 ft.
- Travel distance vertical, upright L_{vs} max.: 9.84 ft.
- Rotated 90°, unsupported L_{90f} max.: 3.28 ft.
- Speed, gliding V_g max.: 16.40 ft/s
- Speed, self-supporting V_f max.: 65.62 ft/s
- Acceleration, gliding a_g max.: 49.21 ft/s²
- Acceleration, self-supporting a_f max.: 164.04 ft/s²

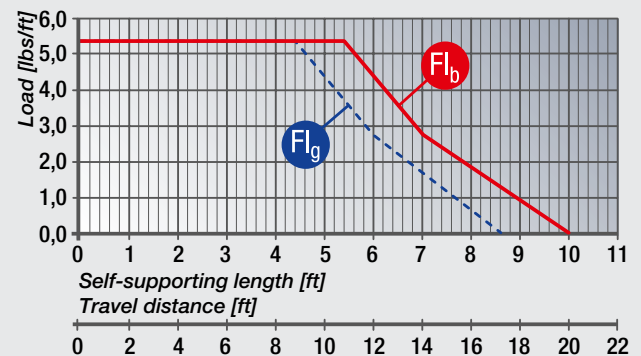

- Travel distance gliding L_g max.: 196.85 ft.
- Travel distance self-supporting L_f max.: see diagram on page 129
- Travel distance vertical, hanging L_{vh} max.: 98.43 ft.
- Travel distance vertical, upright L_{vs} max.: 9.84 ft.
- Rotated 90°, unsupported L_{90f} max.: 3.28 ft.
- Speed, gliding V_g max.: 9.84 ft/s
- Speed, self-supporting V_f max.: 32.81 ft/s
- Acceleration, gliding a_g max.: 49.21 ft/s²
- Acceleration, self-supporting a_f max.: 65.62 ft/s²

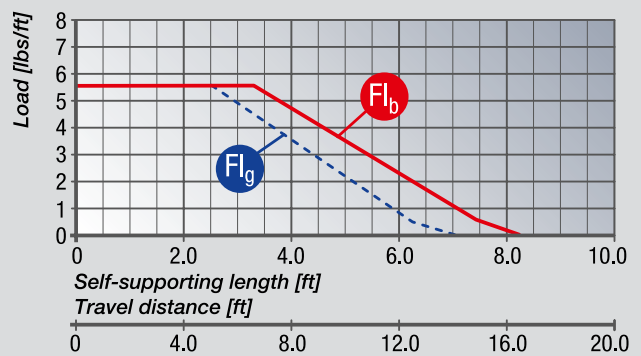

- Travel distance gliding L_g max.: 164.04 ft.
- Travel distance self-supporting L_f max.: see diagram on page 137
- Travel distance vertical, hanging L_{vh} max.: 131.23 ft.
- Travel distance vertical, upright L_{vs} max.: 9.84 ft.
- Rotated 90°, unsupported L_{90f} max.: 3.28 ft.
- Speed, gliding V_g max.: 16.40 ft/s
- Speed, self-supporting V_f max.: 49.21 ft/s
- Acceleration, gliding a_g max.: 49.21 ft/s²
- Acceleration, self-supporting a_f max.: 65.62 ft/s²

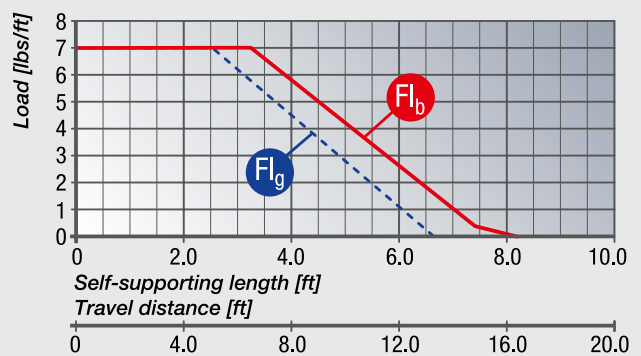

MP Legacy

MP 44

open

Page 366

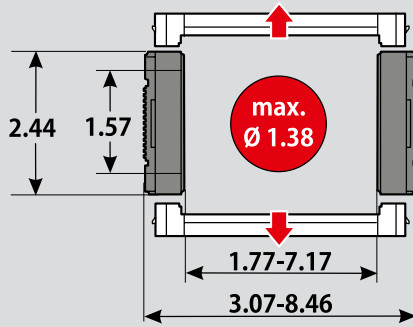

- Internal height: 1.57 inch
- Internal widths: 1.77 – 7.17 inch
- Radii: 3.54 – 15.75 inch
- Grid: 2.97 inch
- Links per foot: 4 qty.
- Loading side: Inside and outside bend

PowerLine

MP 41.2

MP 41.3

open

closed

Page 202

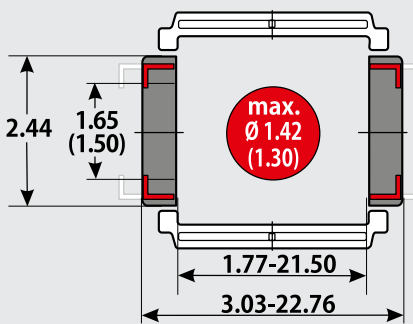

- Internal height: 1.65 inch
- Internal widths: 1.77 – 21.5 inch
- Radii: 3.54 – 13.78 inch
- Grid: 3.03 inch
- Links per foot: 4 qty.
- Loading side: Inside and outside bend
- MP 41.3 inner widths 71–346 mm, radii 150-300 mm, lower inner height (values in brackets)

MP Legacy

MP 41

open

Page 352

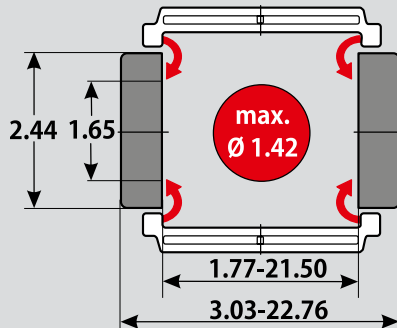

- Internal height: 1.65 inch
- Internal widths: 1.77 – 21.5 inch
- Radii: 3.54 – 13.78 inch
- Grid: 3.03 inch
- Links per foot: 4 qty.
- Loading side: Inside and outside bend

MultiLine

MP 45.1

MP 45.2

open

open

Page 142

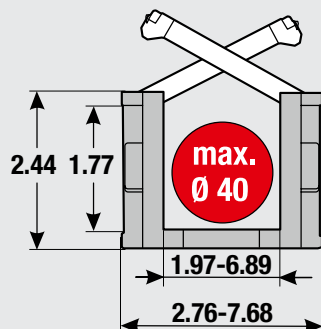

- Internal height: 1.77 inch
- Internal widths: 50.0 – 175.0
- Radii: 75.0 – 300.0
- Grid: 2.64 inch
- Links per foot: 5 qty.
- Loading side: Inside or outside bend

- Travel distance gliding L_g max.: 164.04 ft.
- Travel distance self-supporting L_f max.: see diagram on page 369
- Travel distance vertical, hanging L_{vh} max.: 131.23 ft.
- Travel distance vertical, upright L_{vs} max.: 9.84 ft.
- Rotated 90°, unsupported L_{90f} max.: 3.28 ft.
- Speed, gliding V_g max.: 16.40 ft/s
- Speed, self-supporting V_f max.: 49.21 ft/s
- Acceleration, gliding a_g max.: 49.21 ft/s²
- Acceleration, self-supporting a_f max.: 65.62 ft/s²

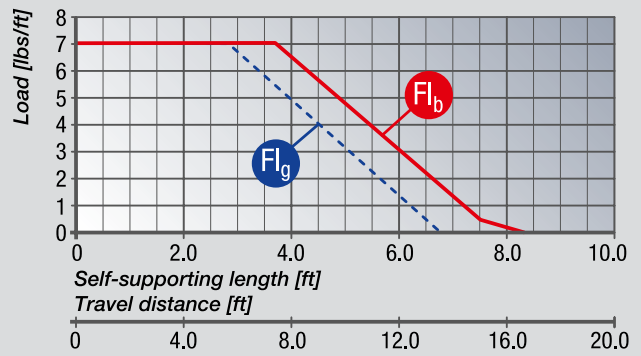

- Travel distance gliding L_g max.: 393.70 ft.
- Travel distance self-supporting L_f max.: see diagram on page 205
- Travel distance vertical, hanging L_{vh} max.: 164.04 ft.
- Travel distance vertical, upright L_{vs} max.: 19.69 ft.
- Rotated 90°, unsupported L_{90f} max.: 3.28 ft.
- Speed, gliding V_g max.: 16.40 ft/s
- Speed, self-supporting V_f max.: 65.62 ft/s
- Acceleration, gliding a_g max.: 82.02 ft/s²
- Acceleration, self-supporting a_f max.: 98.43 ft/s²

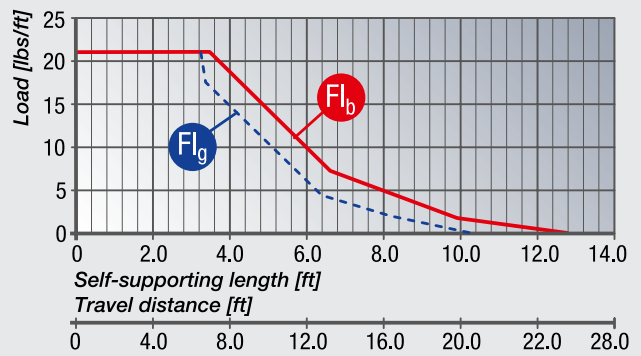

- Travel distance gliding L_g max.: 393.70 ft.
- Travel distance self-supporting L_f max.: see diagram on page 355
- Travel distance vertical, hanging L_{vh} max.: 164.04 ft.
- Travel distance vertical, upright L_{vs} max.: 19.69 ft.
- Rotated 90°, unsupported L_{90f} max.: 6.56 ft.
- Speed, gliding V_g max.: 16.40 ft/s
- Speed, self-supporting V_f max.: 65.62 ft/s
- Acceleration, gliding a_g max.: 82.02 ft/s²
- Acceleration, self-supporting a_f max.: 98.43 ft/s²

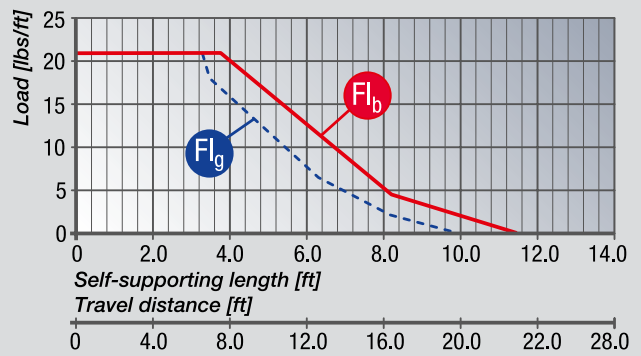

- Travel distance gliding L_g max.: 262.47 ft.
- Travel distance self-supporting L_f max.: see diagram on page 145
- Travel distance vertical, hanging L_{vh} max.: 196.85 ft.
- Travel distance vertical, upright L_{vs} max.: 13.12 ft.
- Rotated 90°, unsupported L_{90f} max.: 3.28 ft.
- Speed, gliding V_g max.: 16.40 ft/s
- Speed, self-supporting V_f max.: 65.62 ft/s
- Acceleration, gliding a_g max.: 49.21 ft/s²
- Acceleration, self-supporting a_f max.: 164.04 ft/s²

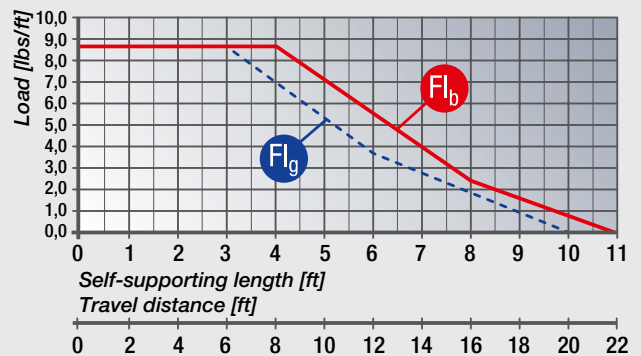

PowerLine
MP 52.2
MP 52.3
open
closed

Page 218

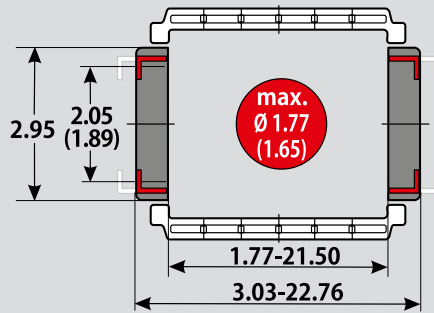

- Internal height: 2.05 inch
- Internal widths: 1.77 – 21.5 inch
- Radii: 3.94 – 13.78 inch
- Grid: 3.58 inch
- Links per foot: 4 qty.
- Loading side: Inside and outside bend
- MP 52.3 inner widths 71–346 mm, radii 150-350 mm, lower inner height (values in brackets)

PowerLine
MP 52.2-D
MP 52.3-D
open
closed

Page 234

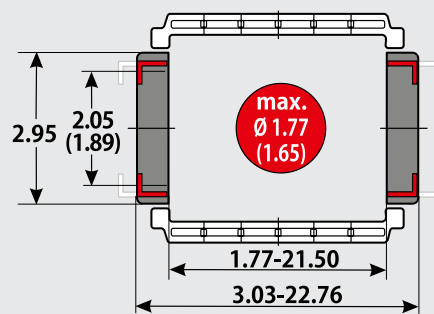

- Internal height: 2.05 inch
- Internal widths: 45.0 – 546.0
- Radii: 200.0
- Grid: 3.58 inch
- Links per foot: 4 qty.
- Loading side: Inside and outside bend

PowerLine
MP 52.4
MP 52.5
open
closed

Page 250

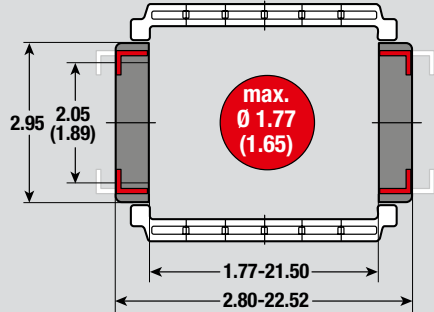

- Internal height: 2.05 inch
- Internal widths: 45.0 – 546.0
- Radii: 125.0 – 300.0
- Grid: 3.58 inch
- Links per foot: 4 qty.
- Loading side: Inside and outside bend

PowerLine
MP 52.6
MP 52.7
open
closed

Page 266

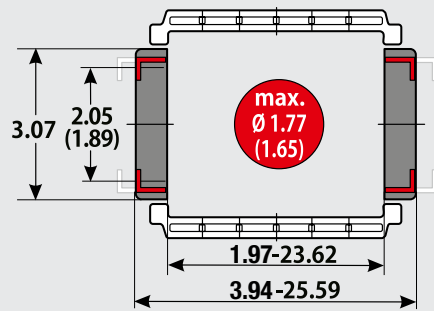

- Internal height: 2.05 inch
- Internal widths: 50.0 – 23.62 inch
- Radii: 150.0 – 11.81 inch
- Grid: 3.58 inch
- Links per foot: 4 qty.
- Loading side: Inside and outside bend

- Travel distance gliding L_g max.: 492.13 ft.
- Travel distance self-supporting L_f max.: see diagram on page 221
- Travel distance vertical, hanging L_{vh} max.: 196.85 ft.
- Travel distance vertical, upright L_{vs} max.: 19.69 ft.
- Rotated 90°, unsupported L_{90f} max.: 6.56 ft.
- Speed, gliding V_g max.: 16.40 ft/s
- Speed, self-supporting V_f max.: 65.62 ft/s
- Acceleration, gliding a_g max.: 82.02 ft/s²
- Acceleration, self-supporting a_f max.: 98.43 ft/s²

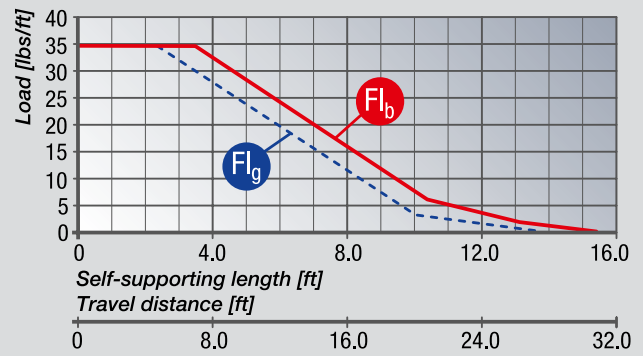

- Travel distance gliding L_g max.: 492.13 ft.
- Travel distance self-supporting L_f max.: see diagram on page 237
- Travel distance vertical, hanging L_{vh} max.: 196.85 ft.
- Travel distance vertical, upright L_{vs} max.: 19.69 ft.
- Rotated 90°, unsupported L_{90f} max.: 6.56 ft.
- Speed, gliding V_g max.: 16.40 ft/s
- Speed, self-supporting V_f max.: 65.62 ft/s
- Acceleration, gliding a_g max.: 82.02 ft/s²
- Acceleration, self-supporting a_f max.: 98.43 ft/s²

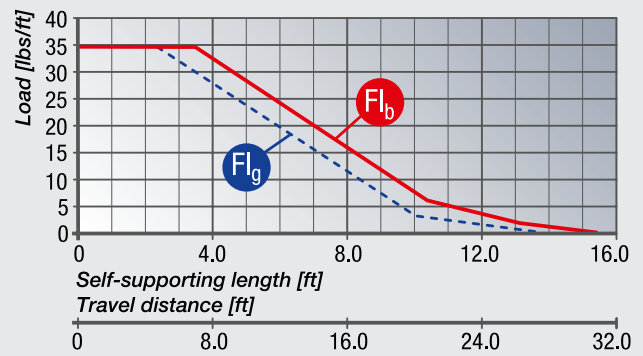

- Travel distance gliding L_g max.: 164.04 ft.
- Travel distance self-supporting L_f max.: see diagram on page 255
- Travel distance vertical, hanging L_{vh} max.: 164.04 ft.
- Travel distance vertical, upright L_{vs} max.: 13.12 ft.
- Rotated 90°, unsupported L_{90f} max.: 3.28 ft.
- Speed, gliding V_g max.: 16.40 ft/s
- Speed, self-supporting V_f max.: 65.62 ft/s
- Acceleration, gliding a_g max.: 82.02 ft/s²
- Acceleration, self-supporting a_f max.: 98.43 ft/s²

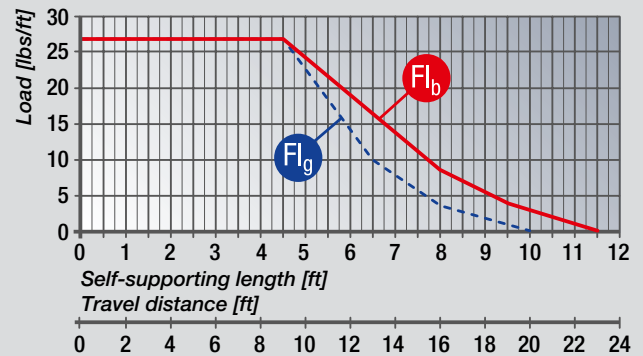

- Travel distance gliding L_g max.: 492.13 ft.
- Travel distance vertical, hanging L_{vh} max.: 262.47 ft.
- Travel distance vertical, upright L_{vs} max.: 19.69 ft.
- Rotated 90°, unsupported L_{90f} max.: 4.92 ft.
- Speed, gliding V_g max.: 19.69 ft/s
- Acceleration, gliding a_g max.: 32.81 ft/s²

MP Legacy

MP 52.1

open

Page 374

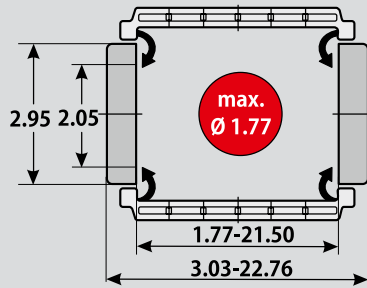

- Internal height: 2.05 inch
- Internal widths: 1.77 – 21.5 inch
- Radii: 3.94 – 13.78 inch
- Grid: 3.58 inch
- Links per foot: 4 qty.
- Loading side: Inside and outside bend

MultiLine

MP 65G

closed

Page 154

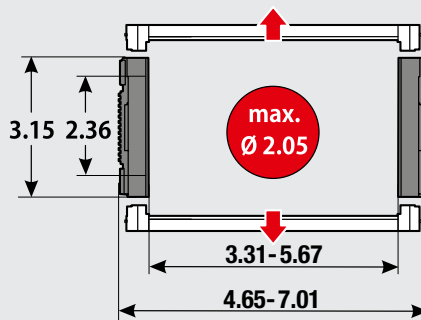

- Internal height: 2.36 inch
- Internal widths: 3.31 – 5.67 inch
- Radii: 7.87 – 15.75 inch
- Grid: 3.60 inch
- Links per foot: 4 qty.
- Loading side: Inside and outside bend

MP Legacy

MP 66

open

Page 400

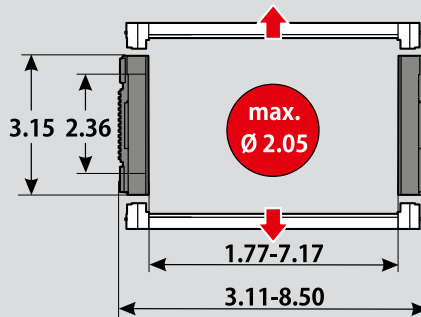

- Internal height: 2.36 inch
- Internal widths: 1.77 – 7.17 inch
- Radii: 5.91 – 15.75 inch
- Grid: 3.60 inch
- Links per foot: 4 qty.
- Loading side: Inside and outside bend

PowerLine

MP 62.4

open

Page 276

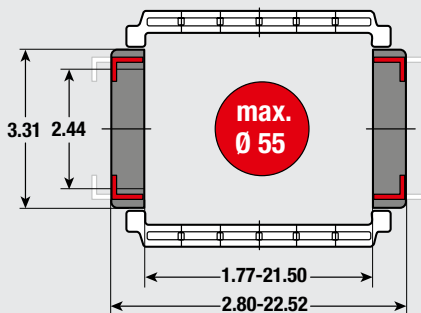

- Internal height: 2.44 inch
- Internal widths: 45.0 – 546.0
- Radii: 135.0 – 300.0
- Grid: 3.58 inch
- Links per foot: 4 qty.
- Loading side: Inside and outside bend

- Travel distance gliding L_g max.: 492.13 ft.
- Travel distance self-supporting L_f max.: see diagram on page 377
- Travel distance vertical, hanging L_{vh} max.: 196.85 ft.
- Travel distance vertical, upright L_{vs} max.: 19.69 ft.
- Rotated 90°, unsupported L_{90f} max.: 9.84 ft.
- Speed, gliding V_g max.: 16.40 ft/s
- Speed, self-supporting V_f max.: 65.62 ft/s
- Acceleration, gliding a_g max.: 82.02 ft/s²
- Acceleration, self-supporting a_f max.: 98.43 ft/s²

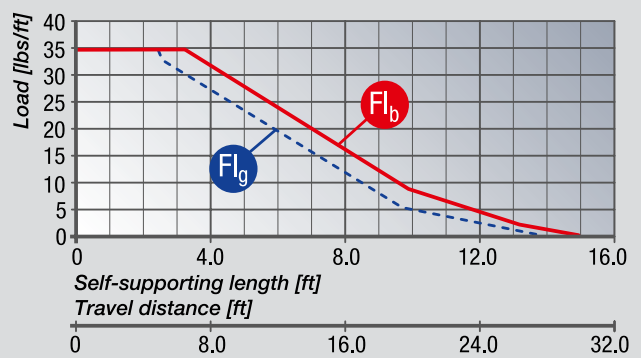

- Travel distance gliding L_g max.: 196.85 ft.
- Travel distance self-supporting L_f max.: see diagram on page 157
- Travel distance vertical, hanging L_{vh} max.: 164.04 ft.
- Travel distance vertical, upright L_{vs} max.: 16.40 ft.
- Rotated 90°, unsupported L_{90f} max.: 6.56 ft.
- Speed, gliding V_g max.: 16.40 ft/s
- Speed, self-supporting V_f max.: 49.21 ft/s
- Acceleration, gliding a_g max.: 49.21 ft/s²
- Acceleration, self-supporting a_f max.: 65.62 ft/s²

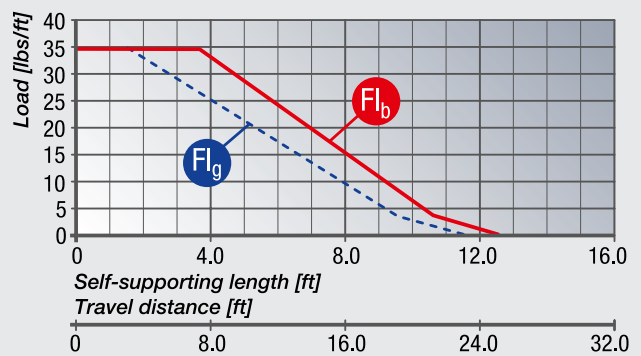

- Travel distance gliding L_g max.: 196.85 ft.
- Travel distance self-supporting L_f max.: see diagram on page 403
- Travel distance vertical, hanging L_{vh} max.: 164.04 ft.
- Travel distance vertical, upright L_{vs} max.: 16.40 ft.
- Rotated 90°, unsupported L_{90f} max.: 6.56 ft.
- Speed, gliding V_g max.: 16.40 ft/s
- Speed, self-supporting V_f max.: 49.21 ft/s
- Acceleration, gliding a_g max.: 49.21 ft/s²
- Acceleration, self-supporting a_f max.: 65.62 ft/s²

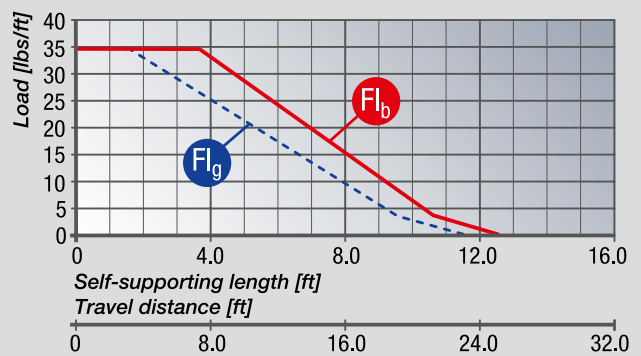

- Travel distance gliding L_g max.: 164.04 ft.
- Travel distance self-supporting L_f max.: see diagram on page 279
- Travel distance vertical, hanging L_{vh} max.: 164.04 ft.
- Travel distance vertical, upright L_{vs} max.: 13.12 ft.
- Rotated 90°, unsupported L_{90f} max.: 3.28 ft.
- Speed, gliding V_g max.: 16.40 ft/s
- Speed, self-supporting V_f max.: 65.62 ft/s
- Acceleration, gliding a_g max.: 82.02 ft/s²
- Acceleration, self-supporting a_f max.: 98.43 ft/s²

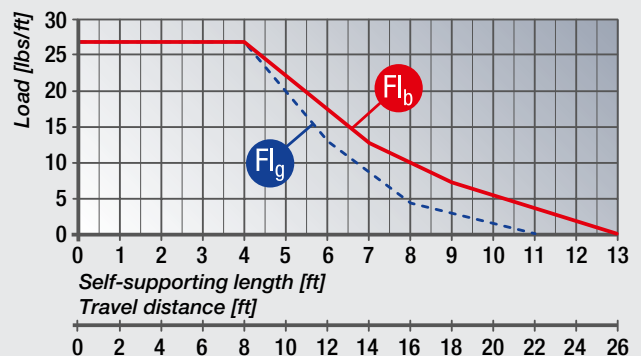

HeavyLine

MP 62.2

MP 62.3

open

closed

Page 290

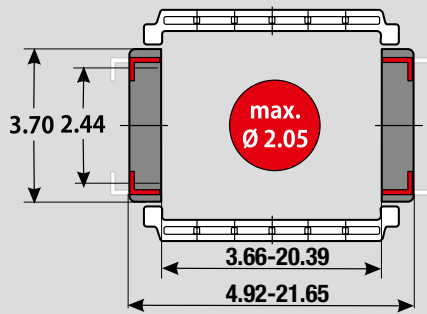

- Internal height: 2.44 inch
- Internal widths: 3.66 – 20.39 inch
- Radii: 5.91 – 19.69 inch
- Grid: 3.94 inch
- Links per foot: 3 qty.
- Loading side: Inside and outside bend
- MP 62.3 inner widths 118–418 mm, radii 200–500 mm

MP Legacy

MP 62.1

open

Page 388

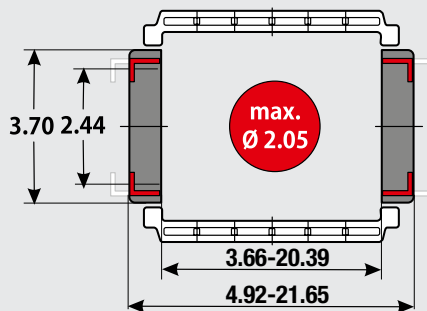

- Internal height: 2.44 inch
- Internal widths: 3.66 – 20.39 inch
- Radii: 5.91 – 19.69 inch
- Grid: 3.94 inch
- Links per foot: 3 qty.
- Loading side: Inside and outside bend

MP Legacy

MP 72

open

Page 408

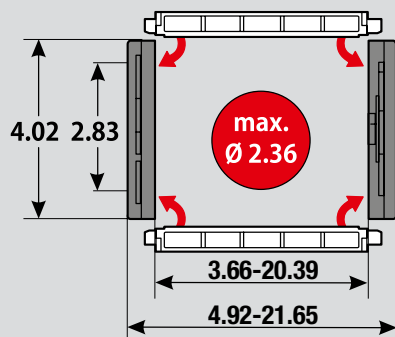

- Internal height: 2.83 inch
- Internal widths: 3.66 – 20.39 inch
- Radii: 5.91 – 19.69 inch
- Grid: 3.94 inch
- Links per foot: 3 qty.
- Loading side: Inside and outside bend

HeavyLine

MP 82.2

MP 82.3

open

closed

Page 304

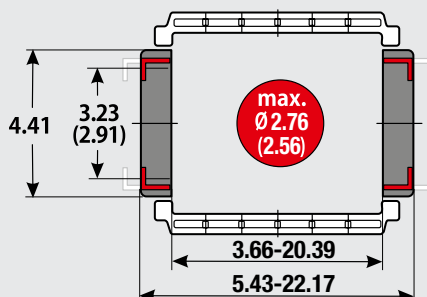

- Internal height: 3.23 inch
- Internal widths: 3.66 – 20.39 inch
- Radii: 5.91 – 25.59 inch
- Grid: 4.65 inch
- Links per foot: 3 qty.
- Loading side: Inside and outside bend
- MP 82.3 inner widths 118–418 mm, radii 200–650 mm, lower inner height (values in brackets)

- Travel distance gliding L_g max.: 492.13 ft.
- Travel distance self-supporting L_f max.: see diagram on page 293
- Travel distance vertical, hanging L_{vh} max.: 213.25 ft.
- Travel distance vertical, upright L_{vs} max.: 19.69 ft.
- Rotated 90°, unsupported L_{90f} max.: 13.12 ft.
- Speed, gliding V_g max.: 16.40 ft/s
- Speed, self-supporting V_f max.: 65.62 ft/s
- Acceleration, gliding a_g max.: 82.02 ft/s²
- Acceleration, self-supporting a_f max.: 131.23 ft/s²

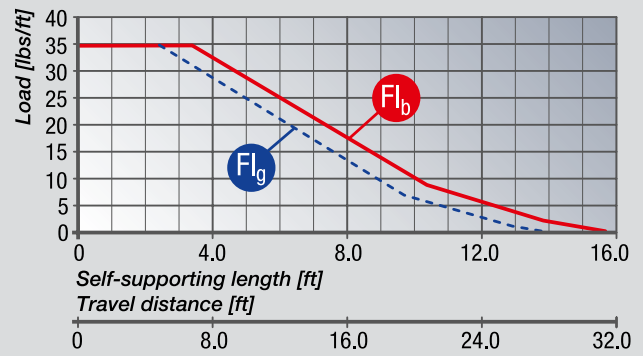

- Travel distance gliding L_g max.: 492.13 ft.
- Travel distance self-supporting L_f max.: see diagram on page 391
- Travel distance vertical, hanging L_{vh} max.: 213.25 ft.
- Travel distance vertical, upright L_{vs} max.: 19.69 ft.
- Rotated 90°, unsupported L_{90f} max.: 13.12 ft.
- Speed, gliding V_g max.: 16.40 ft/s
- Speed, self-supporting V_f max.: 65.62 ft/s
- Acceleration, gliding a_g max.: 82.02 ft/s²
- Acceleration, self-supporting a_f max.: 131.23 ft/s²

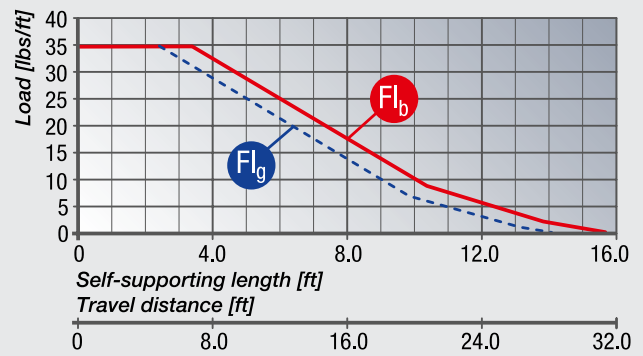

- Travel distance gliding L_g max.: 492.13 ft.
- Travel distance self-supporting L_f max.: see diagram on page 411
- Travel distance vertical, hanging L_{vh} max.: 262.47 ft.
- Travel distance vertical, upright L_{vs} max.: 19.69 ft.
- Rotated 90°, unsupported L_{90f} max.: 19.69 ft.
- Speed, gliding V_g max.: 16.40 ft/s
- Speed, self-supporting V_f max.: 65.62 ft/s
- Acceleration, gliding a_g max.: 82.02 ft/s²
- Acceleration, self-supporting a_f max.: 131.23 ft/s²

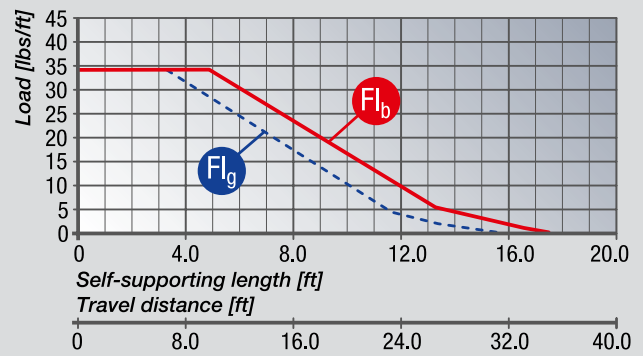

- Travel distance gliding L_g max.: 492.13 ft.
- Travel distance self-supporting L_f max.: see diagram on page 307
- Travel distance vertical, hanging L_{vh} max.: 262.47 ft.
- Travel distance vertical, upright L_{vs} max.: 19.69 ft.
- Rotated 90°, unsupported L_{90f} max.: 9.84 ft.
- Speed, gliding V_g max.: 16.40 ft/s
- Speed, self-supporting V_f max.: 65.62 ft/s
- Acceleration, gliding a_g max.: 82.02 ft/s²
- Acceleration, self-supporting a_f max.: 131.23 ft/s²

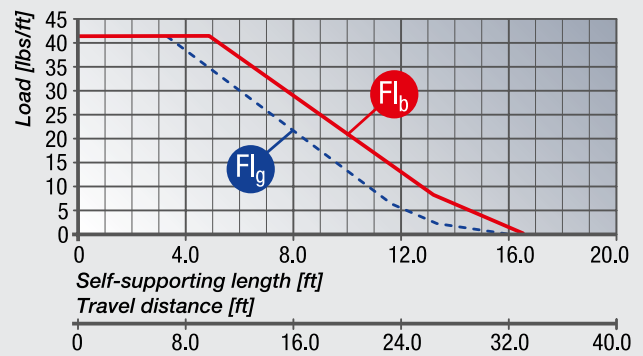

HeavyLine
MP 102.2
open
 Page 318

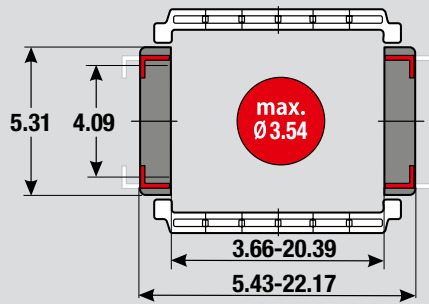

- Internal height: 4.09 inch
- Internal widths: 3.66 – 20.39 inch
- Radii: 9.84 – 19.69 inch
- Grid: 5.55 inch
- Links per foot: 3 qty.
- Loading side: Inside and outside bend

- Travel distance gliding L_g max.: 492.13 ft.
- Travel distance self-supporting L_f max.: see diagram on page 321
- Travel distance vertical, hanging L_{vh} max.: 262.47 ft.
- Travel distance vertical, upright L_{vs} max.: 26.25 ft.
- Rotated 90°, unsupported L_{90f} max.: 26.25 ft.
- Speed, gliding V_g max.: 16.40 ft/s
- Speed, self-supporting V_f max.: 65.62 ft/s
- Acceleration, gliding a_g max.: 82.02 ft/s²
- Acceleration, self-supporting a_f max.: 131.23 ft/s²

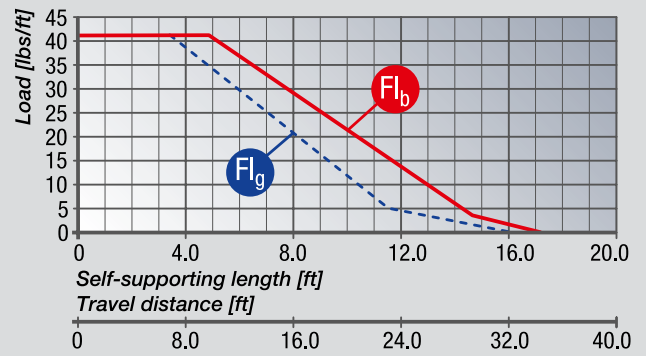

MP 10.1 OPEN



- EASY (FILL) MECHANISM
- CHAIN BRACKET WITH INTEGRATED STRAIN RELIEF
- CAN BE EASILY SHORTENED AND LENGTHENED
- VERY FLEXIBLE, HIGH TORSION

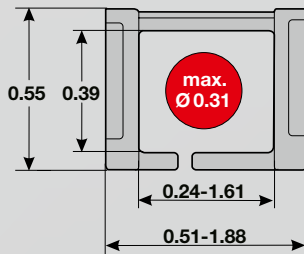

TECHNICAL DATA

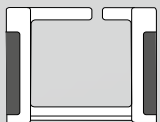

Loading side
Outside bend slitted

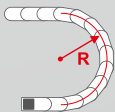

Available radii
0.71 – 2.28 inch

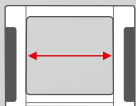

Available interior widths
With plastic crossbar
0.24 – 1.61 inch

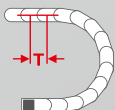

Grid
T = 0.59 inch



TECHNICAL SPECIFICATIONS

Travel distance gliding L_g max.	32.81 ft.
Travel distance self-supporting L_s max.	see diagram on page 65
Travel distance vertical, hanging L_{vh} max.	6.56 ft.
Travel distance vertical, upright L_{vs} max.	3.28 ft.
Rotated 90°, unsupported L_{90f} max.	not recommended
Speed, gliding V_g max.	6.56 ft/s
Speed, self-supporting V_s max.	13.12 ft/s
Acceleration, gliding a_g max.	6.56 ft/s ²
Acceleration, self-supporting a_s max.	6.56 ft/s ²

Contact our engineering department to meet any higher requirements: efk@murrplastik.de



MATERIAL PROPERTIES

Standard material	Polyamide (PA) black
Service temperature	-22.00 – 248.00 °F
Gliding friction factor	0.30
Static friction factor	0.45
Fire classification	Based on UL 94 HB

Other material properties on request

CHAIN BRACKET

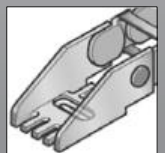

Chain bracket U-part

ORDERING KEY

Dimensions in mm [US inch]

Type code	Variation	Inside width	Outside width	Inside width	Outside width	Radius	Rail variant	Material	Chain length
0101 22	Crossbar on outside bend Crossbar on inside bend Slotted on outside bend	006 ¹⁾ [0.24]	013 [0.51]			018 [0.71]	0 Plastic, full-ridged with bias	0 Polyamide (PA): standard (PA/black)	
		009 [0.35]	016 [0.63]						
		015 [0.59]	022 [0.87]						
		021 [0.83]	028 [1.10]			028 [1.10]		1 UL94 / V0 (PA/oxide red)	
		031 [1.22]	038 [1.50]			038 [1.50]		7 ESD (PA/light gray)	
		041 [1.61]	048 [1.89]			048 [1.89]		9 Special version (on request)	
						058 [2.28]			

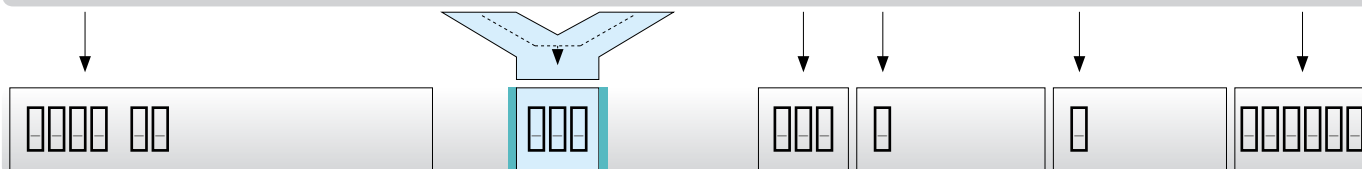

ORDERING EXAMPLE: 0101 006 018 0 0 000041

Crossbar on outside bend, crossbar on inside bend, slotted on outside bend
 Inside width 0.24 in.; radius 0.71 in.
 Plastic crossbar, full-ridged with bias, material black-colored polyamide
 Chain length 41 in. (70 links)

¹⁾ max. line diameter 0.20 in. (5 mm)

SELF-SUPPORTING LENGTH

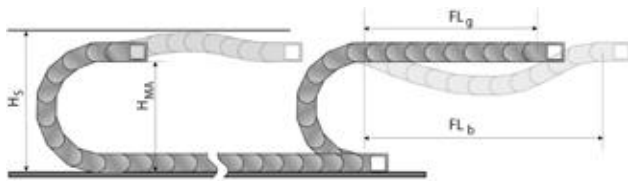

The self-supporting length is the distance between the chain bracket on the moving end and the start of the chain arch.
 The installation variant FL_g offers the lowest load and wear for the cable drag chain.
 The maximum travel parameters (speed and acceleration) can be applied for this variant.

- H_S = Installation height plus safety
- H_{MA} = Height of moving end connection
- FL_g = Self-supporting length, upper run straight
- FL_b = Self-supporting length, upper run bent

LOAD DIAGRAM FOR SELF-SUPPORTING APPLICATIONS

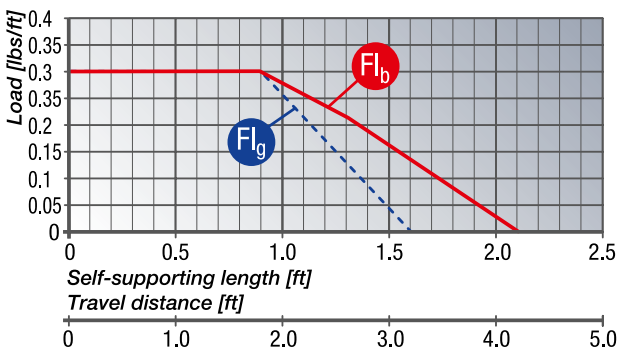

FL_g Self-supporting length, upper run straight
 In the FL_g range, the chain upper run still has a bias, is straight or has a maximum sag of 1.18 inch.

FL_b Self-supporting length, upper run bent
 In the FL_b range, the chain upper run has a sag of more than 1.18 inch, but this is still less than the maximum sag. Where the sag is greater than that permitted in the FL_b range, the application is critical and should be avoided. The self-supporting length can be optimized by using a support for the upper run or a more stable cable drag chain.

DETERMINING THE CHAIN LENGTH

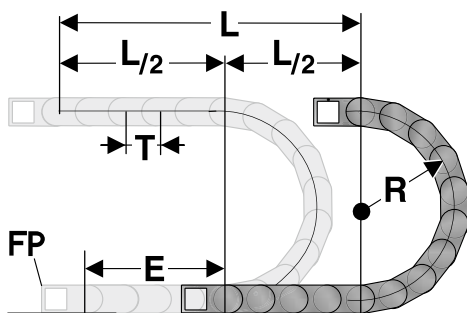

The fixed point of the cable drag chain should be connected in the middle of the travel distance.
 This arrangement gives the shortest connection between the fixed point and the moving bracket and thus the most efficient chain length.

Chain length calculation = $L/2 + \pi * R + 2 * T + E$
 $\approx 1 \text{ ft chain} = 21 \text{ qty.} \times 0.59 \text{ inch.}$

- E = Distance between entry point and middle of travel distance
- L = Travel distance
- R = Radius
- P = Grid 0.59 inch

INSTALLATION DIMENSIONS

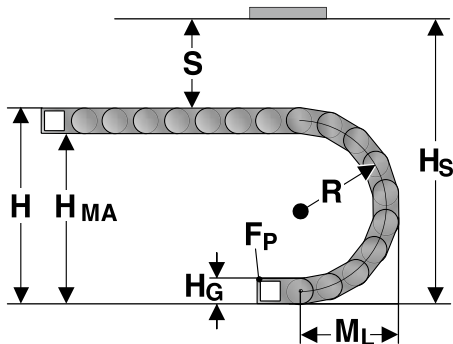

The moving end chain connection is to be screw fixed at height H_{MA} for the respective radius.
For the installed dimension the “Installed height H_S ” value has to be taken into account.

Radius R	0.71	1.10	1.50	1.89	2.28
Outside height of chain link (H_G)	0.55	0.55	0.55	0.55	0.55
Height of bend (H)	1.97	2.75	3.55	4.33	5.11
Height of moving end connection (H_{MA})	1.42	2.20	3.00	3.78	4.56
Safety margin (S)	0.39	0.39	0.39	0.39	0.39
Installation height (H_S)	2.36	3.14	3.94	4.72	5.50
Arc projection (M_L)	1.58	1.97	2.36	2.76	3.14

MP 10.1 CHAMBER SIZE

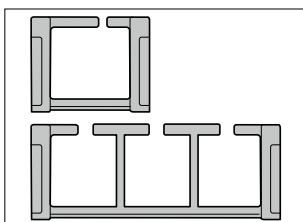

Chamber configuration

Depending on chain width, the MP10.1 is fitted with one, two, three or four chambers. This system of chambers enables cabling to be laid separately.

Type	Number of chambers qty.	Chamber width inch
10.1 006	1	0.26
10.1 009	1	0.37
10.1 015	1	0.61
10.1 021	2	0.37
10.1 031	3	0.37
10.1 041	4	0.35

WIRE INSERTION AID

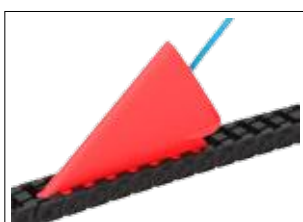

Wire insertion aid

The wire insertion tool allows for quick and simple installation of cables and conduits into the cable drag chain.

Type	Order No.
KE	83729010

KA 10.1 CHAIN BRACKET U-PART

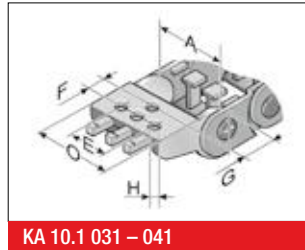
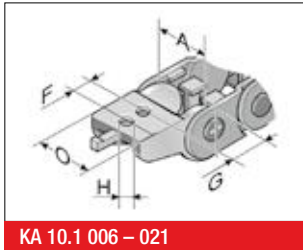

The chain bracket is an all-plastic part. The bracket is precisely adjusted to the respective chain width and only needs to be snapped in at the chain link. Please order one male and one female end bracket for each chain. The brackets should be fastened with M3 screws. The cables or conduits may be fastened with cable ties on the integrated strain relief of the chain bracket.

Type	Order No.	Material	Inside width					Outside width of KA 0 inch
			A inch	E inch	F inch	G inch	HØ inch	
KA 10.1 006 Female end	010100005000	Plastic	0.24		0.31	0.43	0.13	A+0.28
KA 10.1 006 Male end	010100005100	Plastic	0.24		0.31	0.43	0.13	A+0.28
KA 10.1 009 Female end	010100005200	Plastic	0.35		0.31	0.43	0.13	A+0.28
KA 10.1 009 Male end	010100005300	Plastic	0.35		0.31	0.43	0.13	A+0.28
KA 10.1 015 Female end	010100005400	Plastic	0.59		0.31	0.43	0.13	A+0.28
KA 10.1 015 Male end	010100005500	Plastic	0.59		0.31	0.43	0.13	A+0.28
KA 10.1 021 Female end	010100005600	Plastic	0.83		0.31	0.43	0.13	A+0.28
KA 10.1 021 Male end	010100005700	Plastic	0.83		0.31	0.43	0.13	A+0.28
KA 10.1 031 Female end	010100005800	Plastic	1.22	A-0.35	0.31	0.43	0.13	A+0.28
KA 10.1 031 Male end	010100005900	Plastic	1.22	A-0.35	0.31	0.43	0.13	A+0.28
KA 10.1 041 Female end	010100006000	Plastic	1.61	A-0.35	0.31	0.43	0.13	A+0.28
KA 10.1 041 Male end	010100006100	Plastic	1.61	A-0.35	0.31	0.43	0.13	A+0.28

ASSEMBLY

DISASSEMBLY

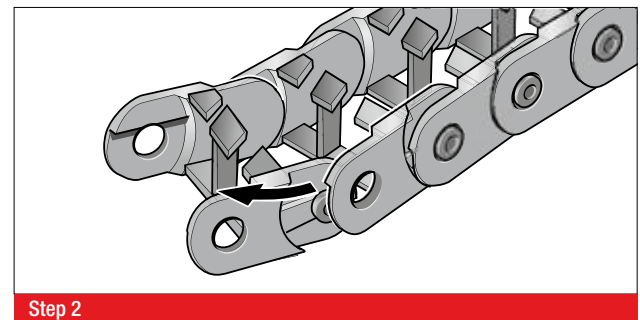
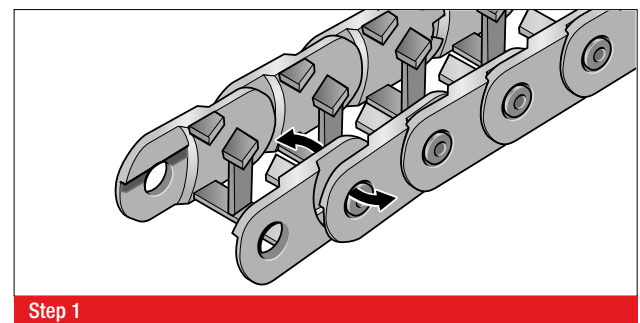
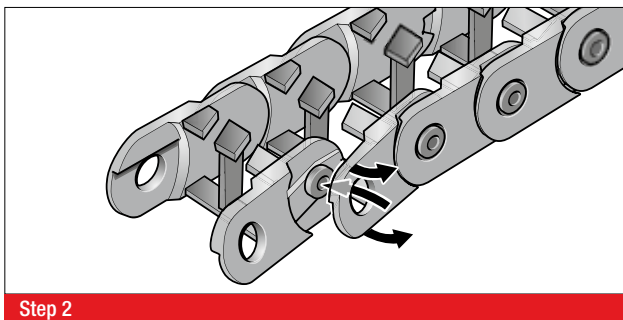
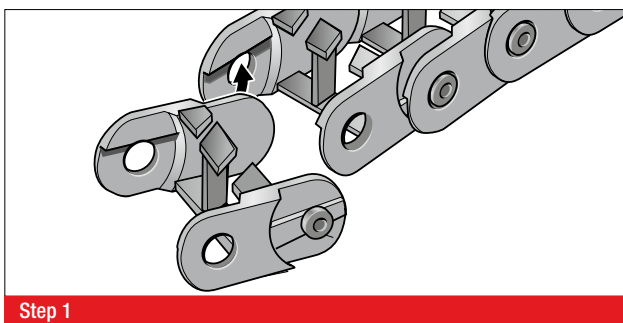

MP 14 OPEN



- LOW-COST VARIANT
- CHAIN BRACKET WITH INTEGRATED STRAIN RELIEF
- CAN BE EASILY SHORTENED AND LENGTHENED

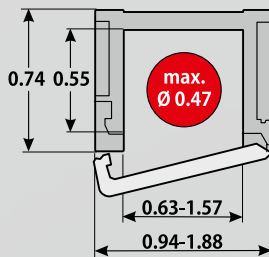

TECHNICAL DATA

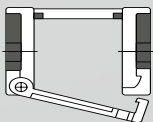

Loading side
Outside bend

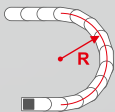

Available radii
0.98 – 2.95 inch

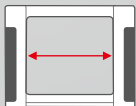

Available interior widths
With plastic crossbar
0.63 – 1.57 inch

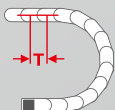

Grid
T = 1.02 inch

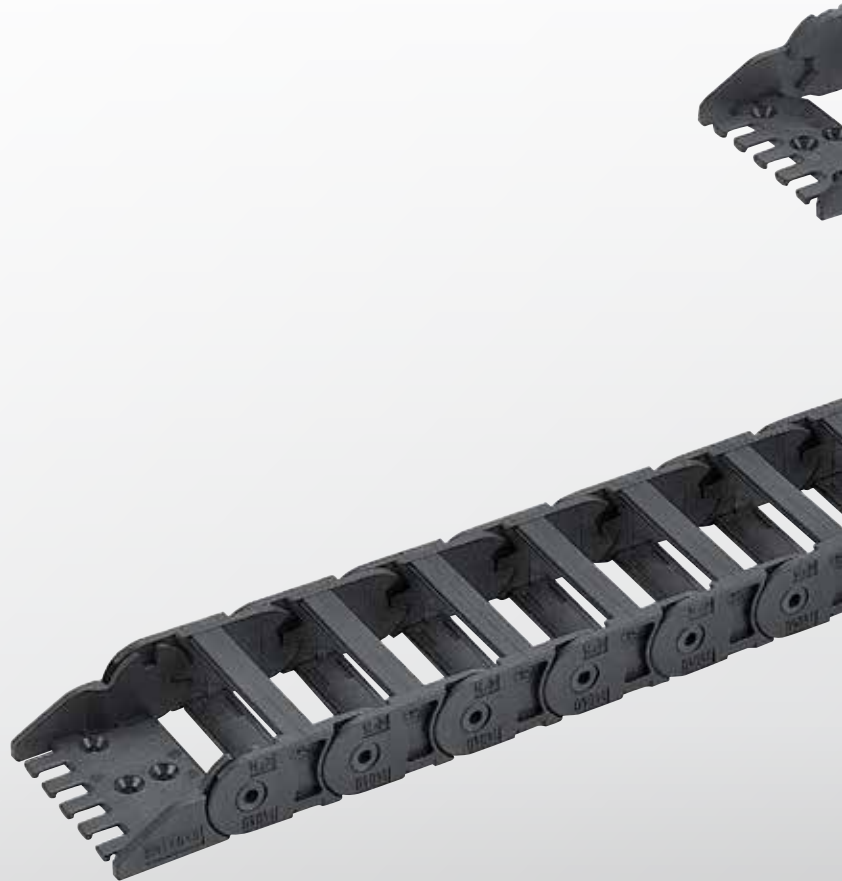

TECHNICAL SPECIFICATIONS

Travel distance gliding L_g max.	39.37 ft.
Travel distance self-supporting L_s max.	see diagram on page 71
Travel distance vertical, hanging L_{vh} max.	9.84 ft.
Travel distance vertical, upright L_{vs} max.	6.56 ft.
Rotated 90°, unsupported L_{90f} max.	not recommended
Speed, gliding V_g max.	6.56 ft/s
Speed, self-supporting V_f max.	13.12 ft/s
Acceleration, gliding a_g max.	6.56 ft/s ²
Acceleration, self-supporting a_s max.	6.56 ft/s ²

Contact our engineering department to meet any higher requirements: efk@murrplastik.de



MATERIAL PROPERTIES

Standard material	Polyamide (PA) black
Service temperature	-22.00 – 248.00 °F
Gliding friction factor	0.30
Static friction factor	0.45
Fire classification	Based on UL 94 HB

Other material properties on request

CHAIN BRACKET

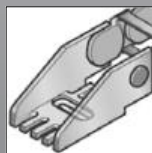

Chain bracket U-part

SHELVING SYSTEM

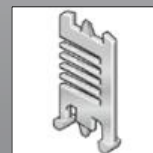

Separator TR

GUIDE CHANNELS



VAW aluminum

ORDERING KEY

Dimensions in mm [US inch]

Type code	Variation	Inside width	Outside width	Inside width	Outside width	Radius	Rail variant	Material	Chain length
0140 01	Crossbar on outside bend Crossbar on inside bend Opens on outside bend	016 [0.63]	024 [0.94]			025 [0.98]	0 Plastic, full-ridged with bias	0 Polyamide (PA): standard (PA/black)	
		020 [0.79]	028 [1.10]						
		030 [1.18]	038 [1.50]						
		040 [1.57]	048 [1.89]			038 [1.50]			
						048 [1.89]			
						075 [2.95]			

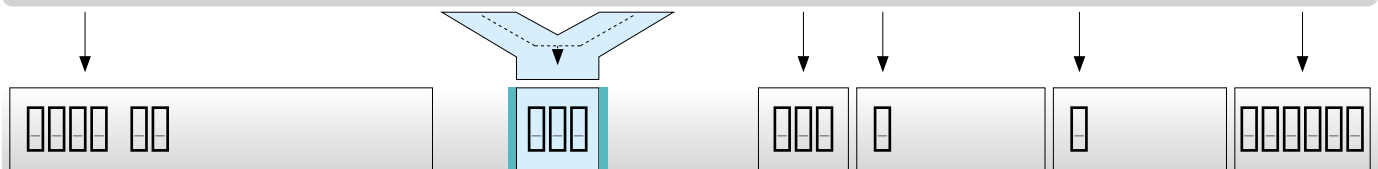

ORDERING EXAMPLE: 0140 01 020 048 0 0 988

Crossbar in inside and outside bend; can be opened in outside bend
 Inside width 0.79 in. (20.00 mm); 1.89 in. (48.00 mm)
 Full-ridged with bias, material black-colored polyamide
 Chain length 38.9 in. (988.00 mm) (38 links)

SELF-SUPPORTING LENGTH

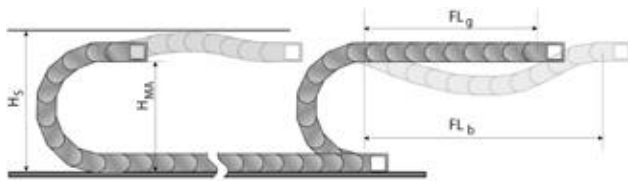

The self-supporting length is the distance between the chain bracket on the moving end and the start of the chain arch.
 The installation variant FL_g offers the lowest load and wear for the cable drag chain.
 The maximum travel parameters (speed and acceleration) can be applied for this variant.

- H_s = Installation height plus safety
- H_{MA} = Height of moving end connection
- FL_g = Self-supporting length, upper run straight
- FL_b = Self-supporting length, upper run bent

LOAD DIAGRAM FOR SELF-SUPPORTING APPLICATIONS

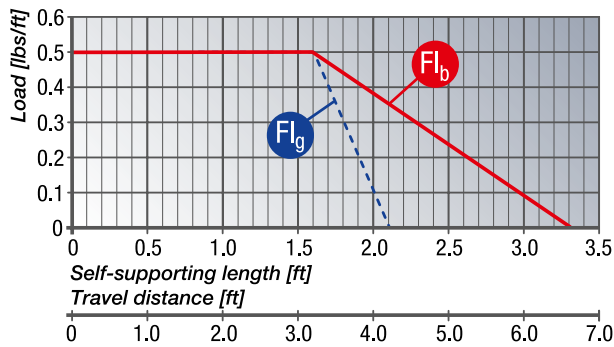

FL_g Self-supporting length, upper run straight
 In the FL_g range, the chain upper run still has a bias, is straight or has a maximum sag of 1.18 inch.

FL_b Self-supporting length, upper run bent
 In the FL_b range, the chain upper run has a sag of more than 1.18 inch, but this is still less than the maximum sag. Where the sag is greater than that permitted in the FL_b range, the application is critical and should be avoided. The self-supporting length can be optimized by using a support for the upper run or a more stable cable drag chain.

DETERMINING THE CHAIN LENGTH

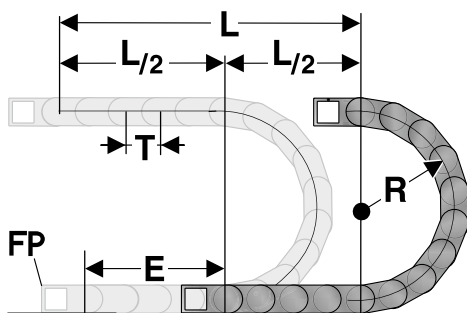

The fixed point of the cable drag chain should be connected in the middle of the travel distance.
 This arrangement gives the shortest connection between the fixed point and the moving bracket and thus the most efficient chain length.

Chain length calculation = $L/2 + \pi * R + 2 * T + E$
 $\approx 1 \text{ ft chain} = 12 \text{ qty.} \times 1.02 \text{ inch.}$

- E = Distance between entry point and middle of travel distance
- L = Travel distance
- R = Radius
- P = Grid 1.02 inch

INSTALLATION DIMENSIONS

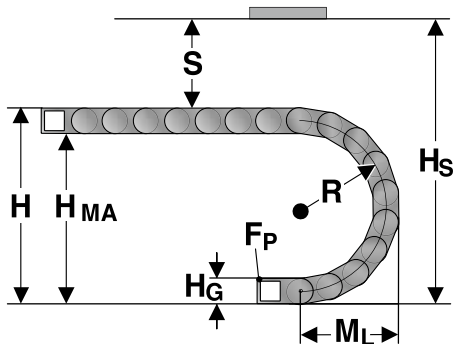

The moving end chain connection is to be screw fixed at height H_{MA} for the respective radius.
For the installed dimension the "Installed height H_S " value has to be taken into account.

Radius R	0.98	1.50	1.89	2.95
Outside height of chain link (H_G)	0.75	0.75	0.75	0.75
Height of bend (H)	2.71	3.75	4.53	6.65
Height of moving end connection (H_{MA})	1.96	3.00	3.78	5.90
Safety margin (S)	0.79	0.79	0.79	0.79
Installation height (H_S)	3.50	4.54	5.32	7.44
Arc projection (M_L)	2.38	2.90	3.28	4.35

KA 14/15 CHAIN BRACKET U-PART

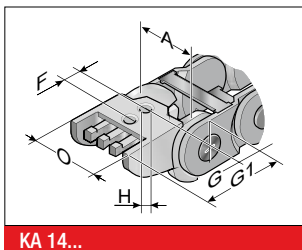

KA 14...

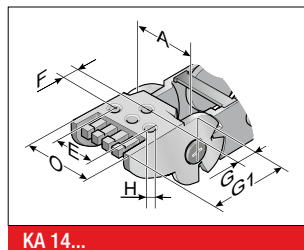

KA 14...

The chain bracket is an all-plastic part. The bracket is precisely adjusted to the respective chain width and only needs to be snapped in at the chain link. Please order one male and one female end bracket for each chain. The brackets should be fastened with M3 screws. The cables or conduits may be fastened with cable ties on the integrated strain relief of the chain bracket.

Type	Order No.	Material	Inside width						Outside width of KA 0
			A inch	E inch	F inch	G inch	G1 inch	HØ inch	
KA 14016 Female end	014000005000	Plastic	0.63		0.31	0.43	1.20	0.13	A+0.31
KA 14016 Male end	014000005100	Plastic	0.63		0.31	0.30	1.20	0.13	A+0.31
KA 14020 Female end	014000005200	Plastic	0.79		0.31	0.43	1.20	0.13	A+0.31
KA 14020 Male end	014000005300	Plastic	0.79		0.31	0.30	1.20	0.13	A+0.31
KA 14030 Female end	014000005400	Plastic	1.18	A-0.31	0.31	0.43	1.20	0.13	A+0.31
KA 14030 Male end	014000005500	Plastic	1.18	A-0.31	0.31	0.30	1.20	0.13	A+0.31
KA 14040 Female end	014000005600	Plastic	1.57	A-0.31	0.31	0.43	1.20	0.13	A+0.31
KA 14040 Male end	014000005700	Plastic	1.57	A-0.31	0.31	0.30	1.20	0.13	A+0.31

MP 14 OPEN

TR 14 SEPARATOR

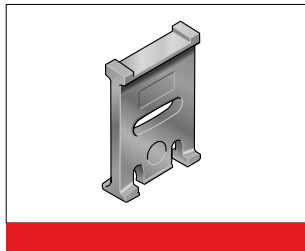
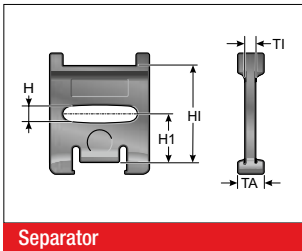

We recommend that separators be used if multiple round cables or conduits with differing diameters are to be installed.

Type	Order No.	Description	Version	TI inch	TA inch	HI inch
TR 14	014000009200	Separator	movable	0.06	0.24	0.55

VAW GUIDE CHANNEL (ALUMINUM)

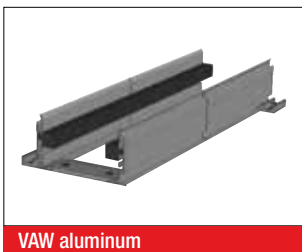

A variable guide channel system, constructed from aluminum sections, is available for this cable drag chain. The variable guide channel ensures that the cable drag chain is supported and guided securely.

ASSEMBLY

DISASSEMBLY

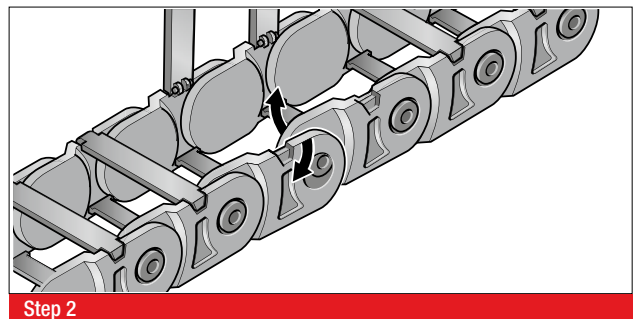
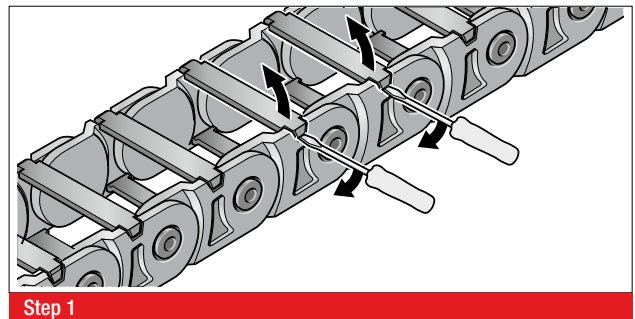
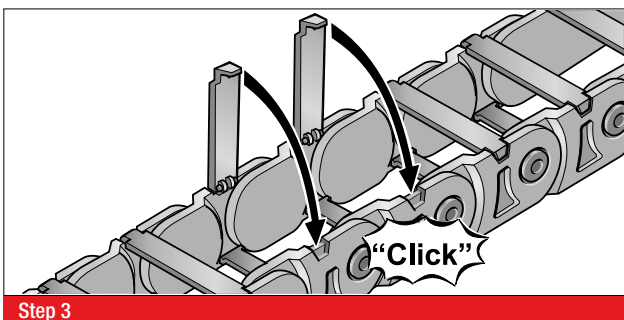
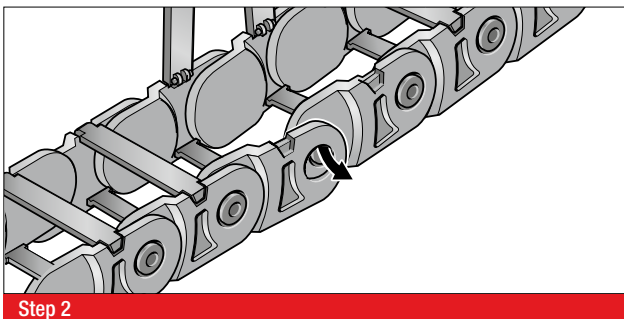
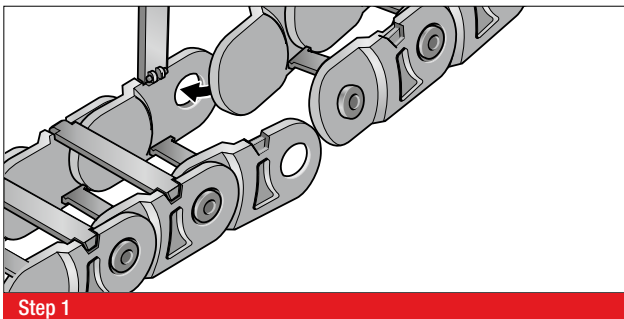

MP 15 OPEN



- LOW-COST VARIANT
- COMPACT DESIGN (NON-OPENING)
- CHAIN BRACKET WITH INTEGRATED STRAIN RELIEF
- CAN BE EASILY SHORTENED AND LENGTHENED
- NON-OPENING

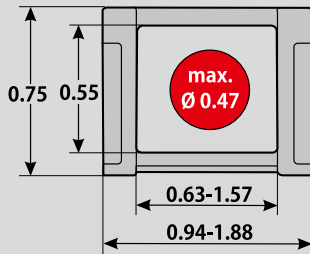

TECHNICAL DATA

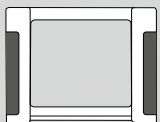

Loading side
Non-opening

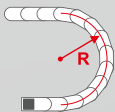

Available radii
0.98 – 2.95 inch

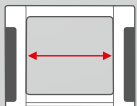

Available interior widths
With plastic crossbar
0.63 – 1.57 inch

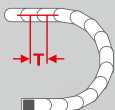

Grid
T = 1.02 inch



TECHNICAL SPECIFICATIONS

Travel distance gliding L_g max.	39.37 ft.
Travel distance self-supporting L_s max.	see diagram on page 77
Travel distance vertical, hanging L_{vh} max.	9.84 ft.
Travel distance vertical, upright L_{vs} max.	6.56 ft.
Rotated 90°, unsupported L_{90f} max.	not recommended
Speed, gliding V_g max.	6.56 ft/s
Speed, self-supporting V_s max.	13.12 ft/s
Acceleration, gliding a_g max.	6.56 ft/s ²
Acceleration, self-supporting a_s max.	6.56 ft/s ²

Contact our engineering department to meet any higher requirements: efk@murrplastik.de



MATERIAL PROPERTIES

Standard material	Polyamide (PA) black
Service temperature	-22.00 – 248.00 °F
Gliding friction factor	0.30
Static friction factor	0.45
Fire classification	Based on UL 94 HB

Other material properties on request

CHAIN BRACKET

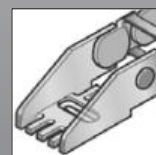

Chain bracket U-part

GUIDE CHANNELS



VAW aluminum

ORDERING KEY

Dimensions in mm [US inch]

Type code	Variation	Inside width	Outside width	Inside width	Outside width	Radius	Rail variant	Material	Chain length
0150 34	Crossbar on outside bend Crossbar on inside bend non-opening	016 [0.63]	024 [0.94]			025 [0.98]	0 Plastic, full-ridged with bias	0 Polyamide (PA): standard (PA/black)	
		020 [0.79]	028 [1.10]						
		030 [1.18]	038 [1.50]			038 [1.50]		1 UL94 / V0 (PA/oxide red)	
		040 [1.57]	048 [1.89]						
						048 [1.89]		7 ESD (PA/light gray)	
						075 [2.95]		9 Special version (on request)	

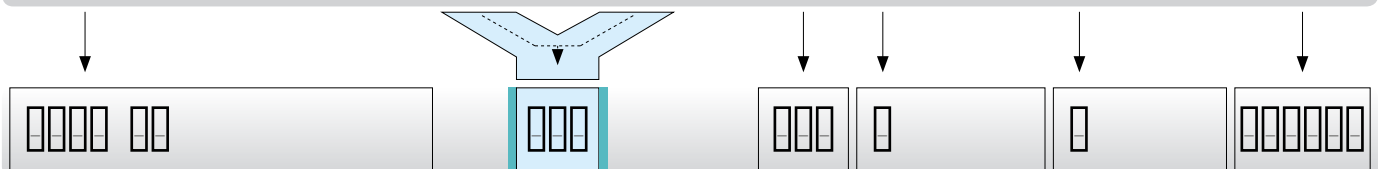

ORDERING EXAMPLE: 0150 016 025 0 0 000042

Crossbar on outside bend, crossbar on inside bend, cannot be opened
 Inside width 0.63 in.; radius 0.98 in.
 Plastic crossbar, full-ridged with bias, material black-colored polyamide
 Chain length 42 in. (42 links)

SELF-SUPPORTING LENGTH

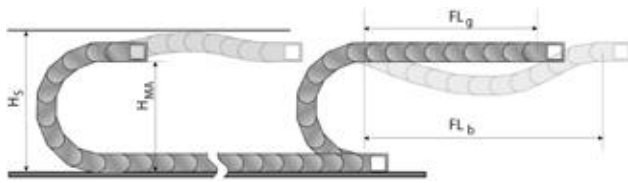

The self-supporting length is the distance between the chain bracket on the moving end and the start of the chain arch.
 The installation variant FL_g offers the lowest load and wear for the cable drag chain.
 The maximum travel parameters (speed and acceleration) can be applied for this variant.

- H_S = Installation height plus safety
- H_{MA} = Height of moving end connection
- FL_g = Self-supporting length, upper run straight
- FL_b = Self-supporting length, upper run bent

LOAD DIAGRAM FOR SELF-SUPPORTING APPLICATIONS

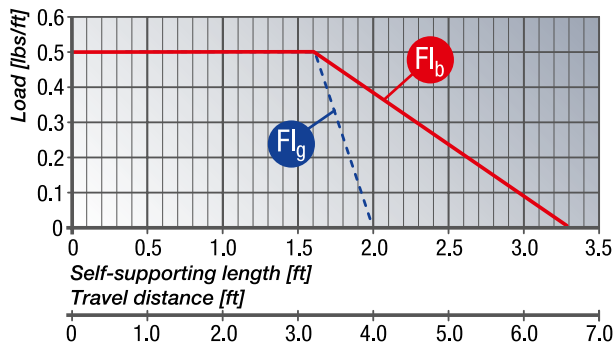

FL_g Self-supporting length, upper run straight

In the FL_g range, the chain upper run still has a bias, is straight or has a maximum sag of 1.18 inch.

FL_b Self-supporting length, upper run bent

In the FL_b range, the chain upper run has a sag of more than 1.18 inch, but this is still less than the maximum sag. Where the sag is greater than that permitted in the FL_b range, the application is critical and should be avoided. The self-supporting length can be optimized by using a support for the upper run or a more stable cable drag chain.

DETERMINING THE CHAIN LENGTH

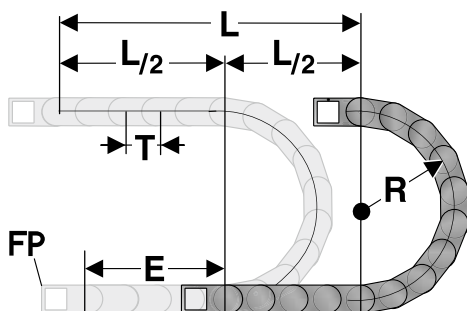

The fixed point of the cable drag chain should be connected in the middle of the travel distance.
 This arrangement gives the shortest connection between the fixed point and the moving bracket and thus the most efficient chain length.

Chain length calculation = $L/2 + \pi * R + 2 * T + E$
 $\approx 1 \text{ ft chain} = 12 \text{ qty.} \times 1.02 \text{ inch.}$

- E = Distance between entry point and middle of travel distance
- L = Travel distance
- R = Radius
- P = Grid 1.02 inch

INSTALLATION DIMENSIONS

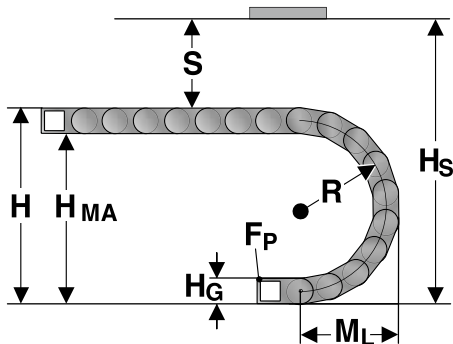

The moving end chain connection is to be screw fixed at height H_{MA} for the respective radius.
For the installed dimension the "Installed height H_s " value has to be taken into account.

Radius R	0.98	1.50	1.89	2.95
Outside height of chain link (H_G)	0.75	0.75	0.75	0.75
Height of bend (H)	2.71	3.75	4.53	6.65
Height of moving end connection (H_{MA})	1.96	3.00	3.78	5.90
Safety margin (S)	0.79	0.79	0.79	0.79
Installation height (H_s)	3.50	4.54	5.32	7.44
Arc projection (M_L)	2.38	2.90	3.28	4.35

KA 14 / 15 CHAIN BRACKET U-PART

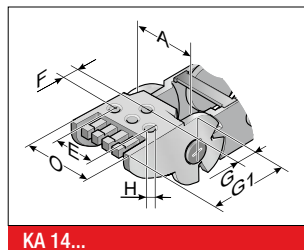
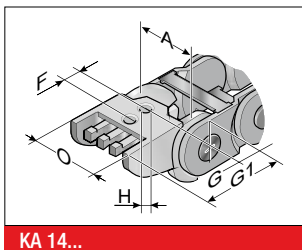

The chain bracket is an all-plastic part. The bracket is precisely adjusted to the respective chain width and only needs to be snapped in at the chain link. Please order one male and one female end bracket for each chain. The brackets should be fastened with M3 screws. The cables or conduits may be fastened with cable ties on the integrated strain relief of the chain bracket.

Type	Order No.	Material	Inside width						Outside width of KA 0 inch
			A inch	E inch	F inch	G inch	G1 inch	HØ inch	
KA 14016 Female end	014000005000	Plastic	0.63		0.31	0.43	1.20	0.13	A+0.31
KA 14016 Male end	014000005100	Plastic	0.63		0.31	0.30	1.20	0.13	A+0.31
KA 14020 Female end	014000005200	Plastic	0.79		0.31	0.43	1.20	0.13	A+0.31
KA 14020 Male end	014000005300	Plastic	0.79		0.31	0.30	1.20	0.13	A+0.31
KA 14030 Female end	014000005400	Plastic	1.18	A-0.31	0.31	0.43	1.20	0.13	A+0.31
KA 14030 Male end	014000005500	Plastic	1.18	A-0.31	0.31	0.30	1.20	0.13	A+0.31
KA 14040 Female end	014000005600	Plastic	1.57	A-0.31	0.31	0.43	1.20	0.13	A+0.31
KA 14040 Male end	014000005700	Plastic	1.57	A-0.31	0.31	0.30	1.20	0.13	A+0.31

VAW GUIDE CHANNEL



A variable guide channel system, constructed from aluminum sections, is available for this cable drag chain. The variable guide channel ensures that the cable drag chain is supported and guided securely.

ASSEMBLY

DISASSEMBLY

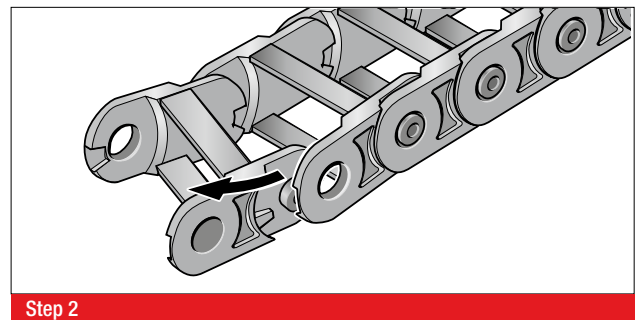
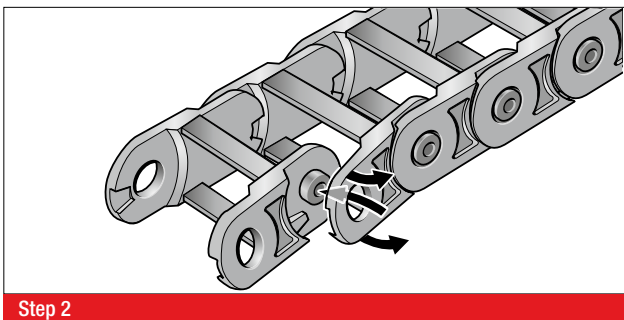
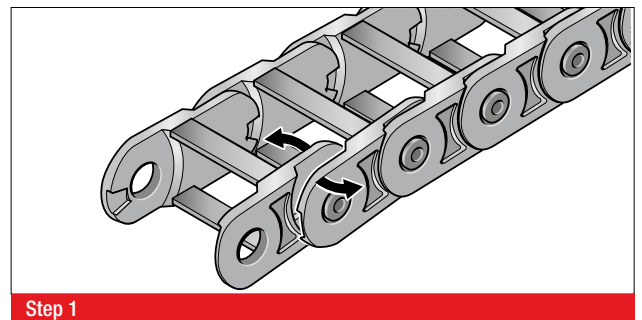
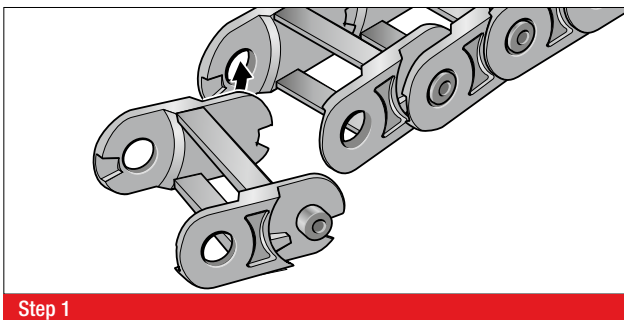

MP 18.1
OPEN



MP 18.2
OPEN



- CHAIN BRACKET WITH INTEGRATED STRAIN RELIEF
- CAN BE EASILY SHORTENED AND LENGTHENED

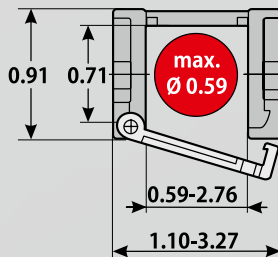

TECHNICAL DATA

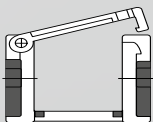

Loading side
Inside or outside bend

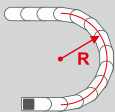

Available radii
1.1 – 3.07 inch

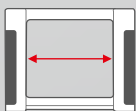

Available interior widths
With plastic crossbar
0.59 – 2.76 inch

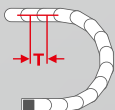

Grid
T = 1.30 inch



TECHNICAL SPECIFICATIONS

Travel distance gliding L_g max.	65.62 ft.
Travel distance self-supporting L_s max.	see diagram on page 83
Travel distance vertical, hanging L_{vh} max.	26.25 ft.
Travel distance vertical, upright L_{vs} max.	9.84 ft.
Rotated 90°, unsupported L_{90f} max.	1.64 ft.
Speed, gliding V_g max.	6.56 ft/s
Speed, self-supporting V_f max.	16.40 ft/s
Acceleration, gliding a_g max.	16.40 ft/s ²
Acceleration, self-supporting a_s max.	16.40 ft/s ²

Contact our engineering department to meet any higher requirements: efk@murrplastik.de



MATERIAL PROPERTIES

Standard material	Polyamide (PA) black
Service temperature	-22.00 – 248.00 °F
Gliding friction factor	0.30
Static friction factor	0.45
Fire classification	UL 94 HB

Other material properties on request

CHAIN BRACKET

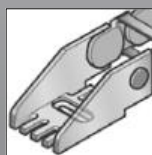

Chain bracket U-part

SHELVING SYSTEM

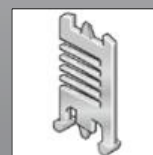

Separator TR

GUIDE CHANNELS



VAW aluminum

ORDERING KEY

Dimensions in mm [US inch]

Type code	Variation	Inside width	Outside width	Inside width	Outside width	Radius	Rail variant	Material	Chain length																																						
0181 01 ¹⁾	MP 18.1 open Crossbar on outside bend Crossbar on inside bend Opens on outside bend	015 ³⁾ [0.59]	028 [1.10]			028 [1.10]	0 Plastic, full-ridged with bias	0 Polyamide (PA): standard (PA/black)																																							
		018 [0.71]	031 [1.22]							0182 02 ²⁾	MP 18.2 open Crossbar on outside bend Crossbar on inside bend Opens on inside of bend	025 [0.98]	038 [1.50]			038 [1.50]		1 UL94 / V0 (PA/oxide red)		037 [1.46]	050 [1.97]					050 [1.97]	063 [2.48]			048 [1.89]		5 Polypropylene (PP/blue)				070 [2.76]	083 [3.27]			078 [3.07]		7 ESD (PA/light gray)					
0182 02 ²⁾	MP 18.2 open Crossbar on outside bend Crossbar on inside bend Opens on inside of bend	025 [0.98]	038 [1.50]			038 [1.50]		1 UL94 / V0 (PA/oxide red)																																							
		037 [1.46]	050 [1.97]									050 [1.97]	063 [2.48]			048 [1.89]		5 Polypropylene (PP/blue)				070 [2.76]	083 [3.27]			078 [3.07]		7 ESD (PA/light gray)										9 Special version (on request)									
		050 [1.97]	063 [2.48]			048 [1.89]		5 Polypropylene (PP/blue)																																							
		070 [2.76]	083 [3.27]			078 [3.07]		7 ESD (PA/light gray)																																							
								9 Special version (on request)																																							

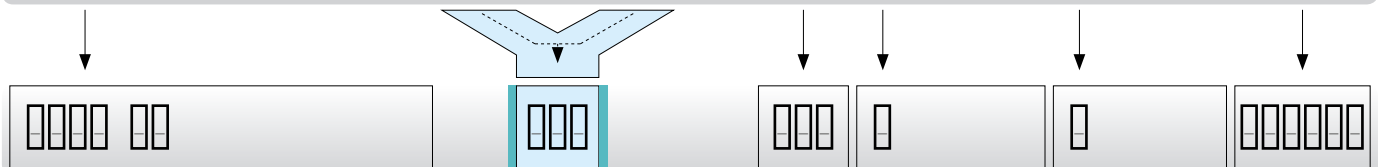

ORDERING EXAMPLE: 0181 015 028 0 0 000044

Crossbar on outside bend, crossbar on inside bend, can be opened from outside bend
 Inside width 0.59 in.; radius 1.10 in.
 Plastic crossbar, full-ridged with bias, material black-colored polyamide
 Chain length 44 in. (34 links)

¹⁾ for Type 0181 only
²⁾ for Type 0182 only
³⁾ max. line diameter 0.51 in. (13.00 mm)

SELF-SUPPORTING LENGTH

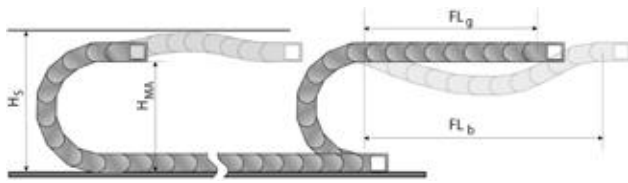

The self-supporting length is the distance between the chain bracket on the moving end and the start of the chain arch.
 The installation variant FL_g offers the lowest load and wear for the cable drag chain.
 The maximum travel parameters (speed and acceleration) can be applied for this variant.

- H_S = Installation height plus safety
- H_{MA} = Height of moving end connection
- FL_g = Self-supporting length, upper run straight
- FL_b = Self-supporting length, upper run bent

LOAD DIAGRAM FOR SELF-SUPPORTING APPLICATIONS

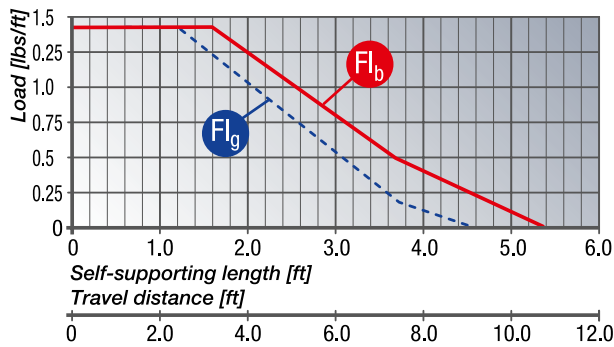

FL_g Self-supporting length, upper run straight
 In the FL_g range, the chain upper run still has a bias, is straight or has a maximum sag of 1.57 inch.

FL_b Self-supporting length, upper run bent
 In the FL_b range, the chain upper run has a sag of more than 1.57 inch, but this is still less than the maximum sag. Where the sag is greater than that permitted in the FL_b range, the application is critical and should be avoided. The self-supporting length can be optimized by using a support for the upper run or a more stable cable drag chain.

DETERMINING THE CHAIN LENGTH

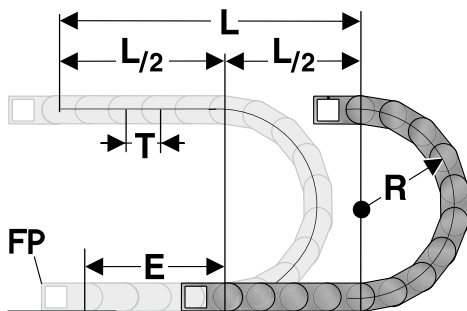

The fixed point of the cable drag chain should be connected in the middle of the travel distance.
 This arrangement gives the shortest connection between the fixed point and the moving bracket and thus the most efficient chain length.

Chain length calculation = $L/2 + \pi * R + 2 * T + E$
 $\approx 1 \text{ ft chain} = 10 \text{ qty.} \times 1.30 \text{ inch.}$

- E = Distance between entry point and middle of travel distance
- L = Travel distance
- R = Radius
- P = Grid 1.30 inch

INSTALLATION DIMENSIONS

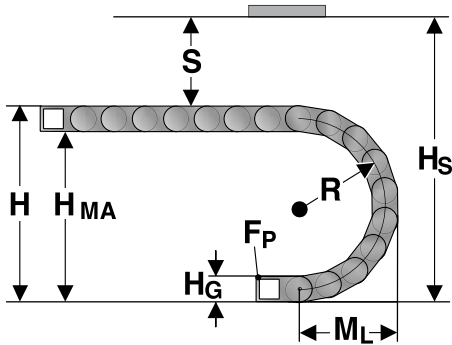

The moving end chain connection is to be screw fixed at height H_{MA} for the respective radius.
For the installed dimension the “Installed height H_S ” value has to be taken into account.

Radius R	1.10	1.50	1.89	3.07
Outside height of chain link (H_G)	0.91	0.91	0.91	0.91
Height of bend (H)	3.11	3.91	4.69	7.05
Height of moving end connection (H_{MA})	2.20	3.00	3.78	6.14
Safety margin (S)	1.18	1.18	1.18	1.18
Installation height (H_S)	4.29	5.09	5.87	8.23
Arc projection (M_L)	2.86	3.26	3.64	4.83

KA 18.1 / 18.2 CHAIN BRACKET U-PART

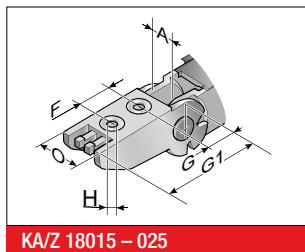

KA/Z 18015 – 025

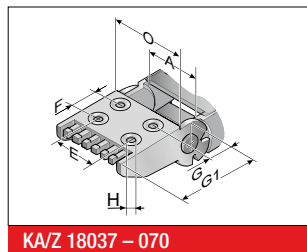

KA/Z 18037 – 070

The chain bracket is an all-plastic part. The bracket is precisely adjusted to the respective chain width and only needs to be snapped in at the chain link. Please order one male and one female end bracket for each chain. The brackets should be fastened with M5 screws. The cables or conduits may be fastened with cable ties on the integrated strain relief of the chain bracket.

Type	Order No.	Material	Inside width						Outside width of KA O inch
			A inch	E inch	F inch	G inch	G1 inch	H0 inch	
KA/Z 18015 Female end	018100004800	Plastic	0.61		0.75	0.41	2.09	0.22	A+0.51
KA/Z 18015 male end	018100004900	Plastic	0.61		0.75	0.33	2.09	0.22	A+0.51
KA/Z 18018 Female end	018100005000	Plastic	0.72		0.75	0.41	2.09	0.22	A+0.51
KA/Z 18018 male end	018100005100	Plastic	0.72		0.75	0.33	2.09	0.22	A+0.51
KA/Z 18025 Female end	018100005200	Plastic	1.00		0.75	0.41	2.09	0.22	A+0.51
KA/Z 18025 male end	018100005300	Plastic	1.00		0.75	0.33	2.09	0.22	A+0.51
KA/Z 18037 Female end	018100005400	Plastic	1.47	A-0.69	0.75	0.41	2.09	0.22	A+0.51
KA/Z 18037 male end	018100005500	Plastic	1.47	A-0.69	0.75	0.33	2.09	0.22	A+0.51
KA/Z 18050 Female end	018100005600	Plastic	1.98	A-0.65	0.75	0.41	2.09	0.22	A+0.51
KA/Z 18050 male end	018100005700	Plastic	1.98	A-0.65	0.75	0.33	2.09	0.22	A+0.51
KA/Z 18070 Female end	018100005800	Plastic	2.77	A-0.88	0.75	0.41	2.09	0.22	A+0.51
KA/Z 18070 male end	018100005900	Plastic	2.77	A-0.88	0.75	0.33	2.09	0.22	A+0.51

TR 18.1/2 SEPARATOR

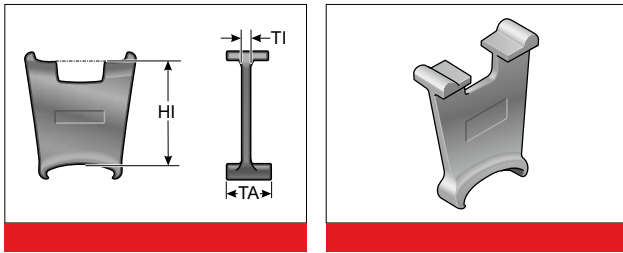

We recommend that separators be used if multiple round cables or conduits with differing diameters are to be installed.

Type	Order No.	Description	T1 inch	HI inch
TR 14/18	018200009000	Separator	0.06	0.71

VAW GUIDE CHANNEL

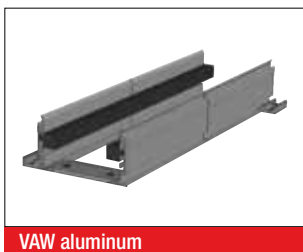

A variable guide channel system, constructed from aluminum sections, is available for this cable drag chain. The variable guide channel ensures that the cable drag chain is supported and guided securely.

ASSEMBLY

DISASSEMBLY

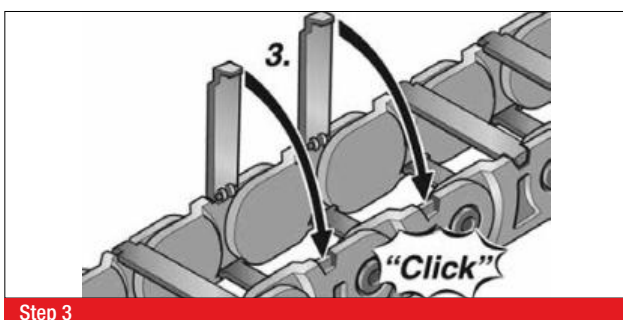
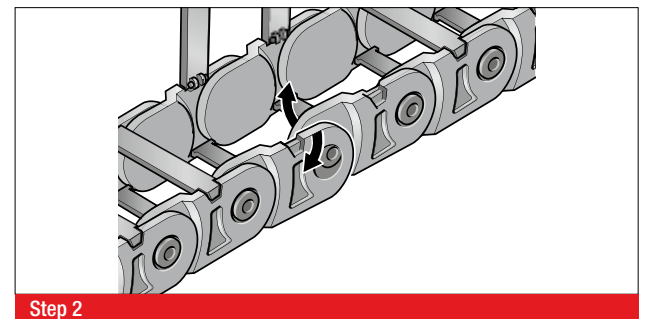
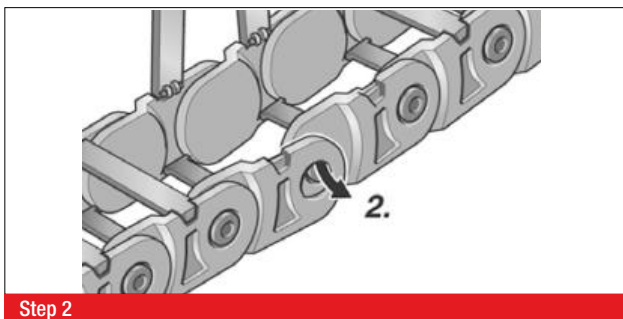
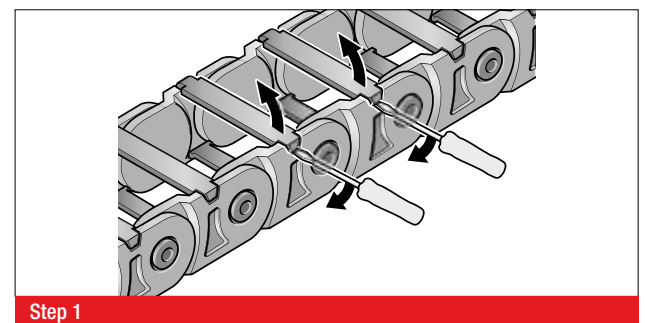
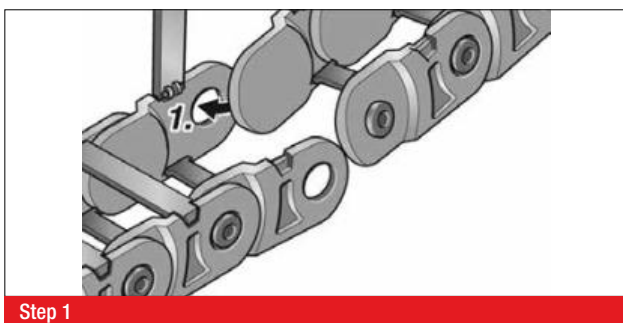

MP 18.4 OPEN



- HIGH LEVEL OF STABILITY
- CHAIN BRACKET WITH INTEGRATED STRAIN RELIEF
- VERY FLEXIBLE, HIGH TORSION
- NON-OPENING

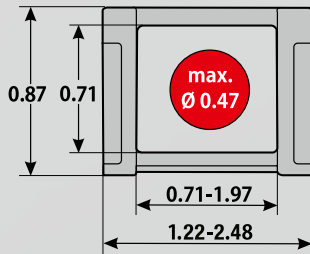

TECHNICAL DATA

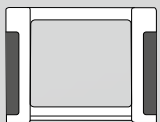

Loading side
Non-opening

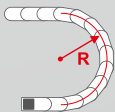

Available radii
1.57 – 3.15 inch

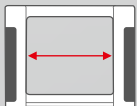

Available interior widths
With plastic crossbar
0.71 – 1.97 inch

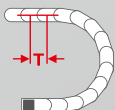

Grid
T = 1.30 inch

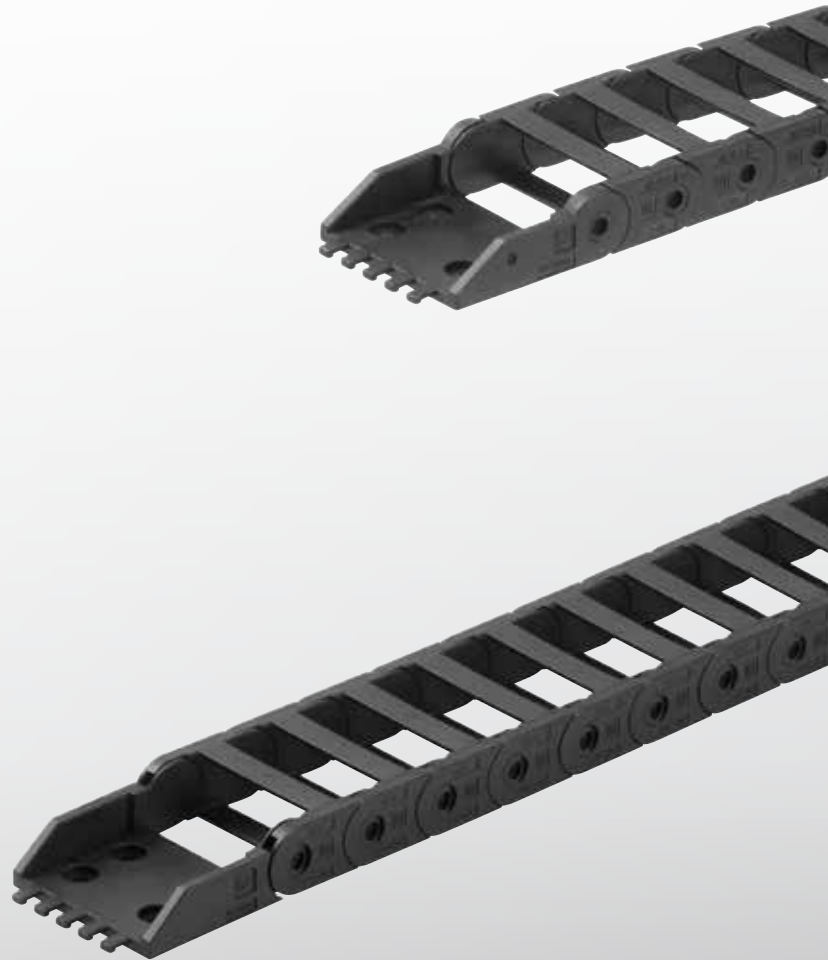



TECHNICAL SPECIFICATIONS

Travel distance gliding L_g max.	65.62 ft.
Travel distance self-supporting L_s max.	see diagram on page 89
Travel distance vertical, hanging L_{vh} max.	26.25 ft.
Travel distance vertical, upright L_{vs} max.	9.84 ft.
Rotated 90°, unsupported L_{90f} max.	1.64 ft.
Speed, gliding V_g max.	6.56 ft/s
Speed, self-supporting V_f max.	16.40 ft/s
Acceleration, gliding a_g max.	16.40 ft/s ²
Acceleration, self-supporting a_s max.	16.40 ft/s ²

Contact our engineering department to meet any higher requirements: efk@murrplastik.de

MATERIAL PROPERTIES

Standard material	Polyamide (PA) black
Service temperature	-22.00 – 248.00 °F
Gliding friction factor	0.30
Static friction factor	0.45
Fire classification	UL 94 HB

Other material properties on request

CHAIN BRACKET

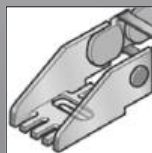

Chain bracket U-part

SHELVING SYSTEM

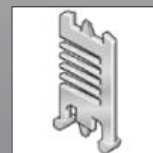

Separator TR

GUIDE CHANNELS



VAW aluminum

ORDERING KEY

Dimensions in mm [US inch]

Type code	Variation	Inside width	Outside width	Inside width	Outside width	Radius	Rail variant	Material	Chain length
0184 34	Crossbar on outside bend Crossbar on inside bend non-opening	018 [0.71]	031 [1.22]			040¹⁾ [1.57]	0 Plastic, full-ridged with bias	0 Polyamide (PA): standard (PA/black)	
		025 [0.98]	038 [1.50]						
		037 [1.46]	050 [1.97]			050²⁾ [1.97]			
		050 [1.97]	063 [2.48]						
						080³⁾ [3.15]			

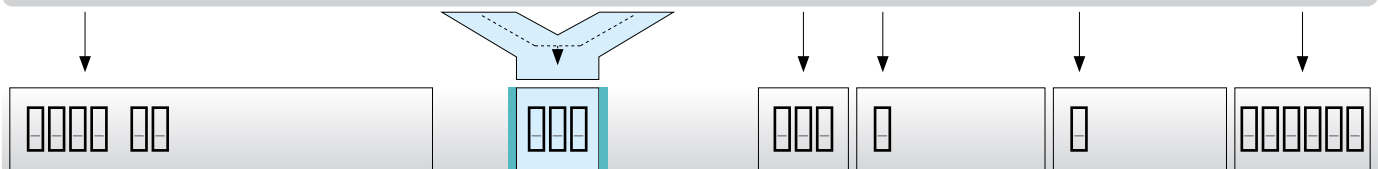

ORDERING EXAMPLE: 0184 34 025 050 0 0 1020

Crossbar on outside bend, crossbar on inside bend, cannot be opened
 Inside width 0,98 in. (25,00 mm); radius 1,97 in. (50,00 mm)
 Plastic crossbar, full-ridged with bias, material black-colored polyamide
 Chain length 40,16 in. (1020,00 mm) (34 links)

¹⁾ only for inner width of 0.71, 0.98, 1.47 in. (18, 25, 37 mm)
²⁾ only for inner width of 0.71 in. (18 mm)
³⁾ only for inner width of 0.98, 1.97 in. (25, 50 mm)

SELF-SUPPORTING LENGTH

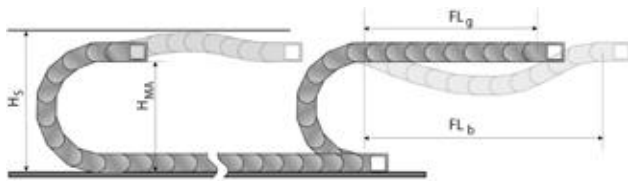

The self-supporting length is the distance between the chain bracket on the moving end and the start of the chain arch.
 The installation variant FL_g offers the lowest load and wear for the cable drag chain.
 The maximum travel parameters (speed and acceleration) can be applied for this variant.

- H_S = Installation height plus safety
- H_{MA} = Height of moving end connection
- FL_g = Self-supporting length, upper run straight
- FL_b = Self-supporting length, upper run bent

LOAD DIAGRAM FOR SELF-SUPPORTING APPLICATIONS

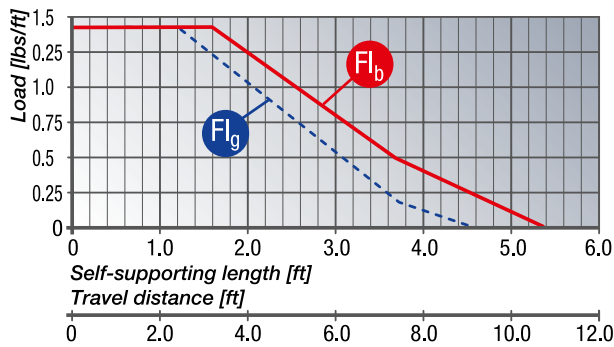

FL_g Self-supporting length, upper run straight

In the FL_g range, the chain upper run still has a bias, is straight or has a maximum sag of 1.57 inch.

FL_b Self-supporting length, upper run bent

In the FL_b range, the chain upper run has a sag of more than 1.57 inch, but this is still less than the maximum sag. Where the sag is greater than that permitted in the FL_b range, the application is critical and should be avoided. The self-supporting length can be optimized by using a support for the upper run or a more stable cable drag chain.

DETERMINING THE CHAIN LENGTH

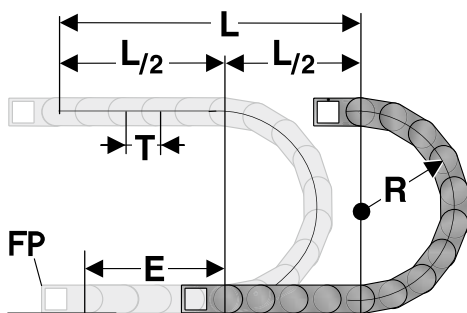

The fixed point of the cable drag chain should be connected in the middle of the travel distance.
 This arrangement gives the shortest connection between the fixed point and the moving bracket and thus the most efficient chain length.

$$\text{Chain length calculation} = L/2 + \pi * R + 2 * T + E$$

$$\approx 1 \text{ ft chain} = 11 \text{ qty.} \times 1.30 \text{ inch.}$$

- E = Distance between entry point and middle of travel distance
- L = Travel distance
- R = Radius
- P = Grid 1.30 inch

INSTALLATION DIMENSIONS

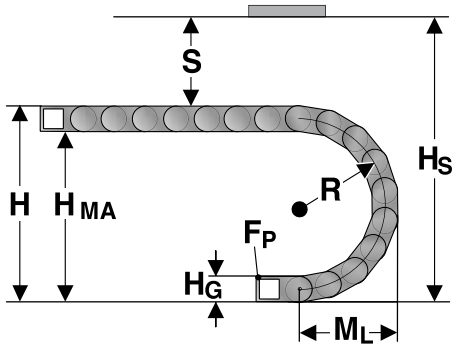

The moving end chain connection is to be screw fixed at height H_{MA} for the respective radius.
For the installed dimension the “Installed height H_S ” value has to be taken into account.

Radius R	1.57	1.97	3.15
Outside height of chain link (H_G)	0.91	0.91	0.91
Height of bend (H)	4.05	4.85	7.21
Height of moving end connection (H_{MA})	3.14	3.94	6.30
Safety margin (S)	1.18	1.18	1.18
Installation height (H_S)	5.23	6.03	8.39
Arc projection (M_L)	3.33	3.72	4.91

KA 18.4 CHAIN BRACKET U-PART

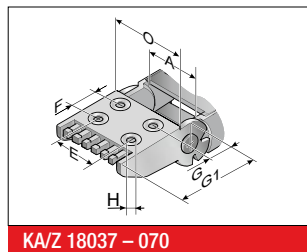
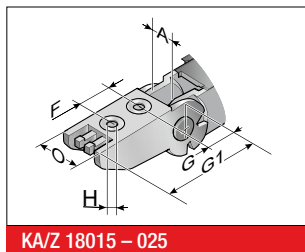

The chain bracket is an all-plastic part. The bracket is precisely adjusted to the respective chain width and only needs to be snapped in at the chain link. Please order one male and one female end bracket for each chain. The brackets should be fastened with M5 screws. The cables or conduits may be fastened with cable ties on the integrated strain relief of the chain bracket.

Type	Order No.	Material	Inside width						Outside width of KA 0 inch
			A inch	E inch	F inch	G inch	G1 inch	HØ inch	
KA/Z 18.4 018 Female end	018400005000	Plastic	0.71		0.75	0.91	2.24	0.22	A+0.51
KA/Z 18.4 018 Male end	018400005100	Plastic	0.71		0.75	0.91	2.24	0.22	A+0.51
KA/Z 18.4 025 Female end	018400005200	Plastic	0.98		0.75	0.91	2.24	0.22	A+0.51
KA/Z 18.4 025 Male end	018400005300	Plastic	0.98		0.75	0.98	2.32	0.22	A+0.51
KA/Z 18.4 037 Female end	018400005400	Plastic	1.46	A-0.67	0.75	0.91	2.24	0.22	A+0.51
KA/Z 18.4 037 Male end	018400005500	Plastic	1.46	A-0.67	0.75	0.98	2.32	0.22	A+0.51
KA/Z 18.4 050 Female end	018400005600	Plastic	1.97	A-0.63	0.75	0.91	2.24	0.22	A+0.51
KA/Z 18.4 050 Male end	018400005700	Plastic	1.97	A-0.63	0.75	0.98	2.32	0.22	A+0.51

TR 18.1/2 SEPARATOR

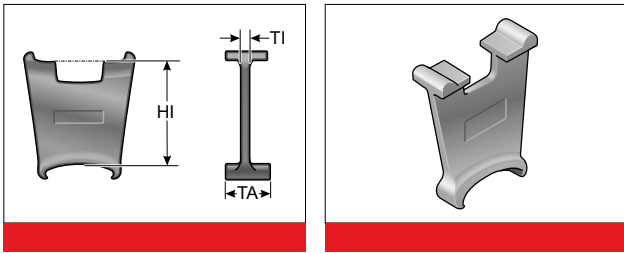

We recommend that separators be used if multiple round cables or conduits with differing diameters are to be installed.

Type	Order No.	Description	TI inch	HI inch
TR 14/18	018200009000	Separator	0.06	0.71

VAW GUIDE CHANNEL



A variable guide channel system, constructed from aluminum sections, is available for this cable drag chain. The variable guide channel ensures that the cable drag chain is supported and guided securely.

ASSEMBLY

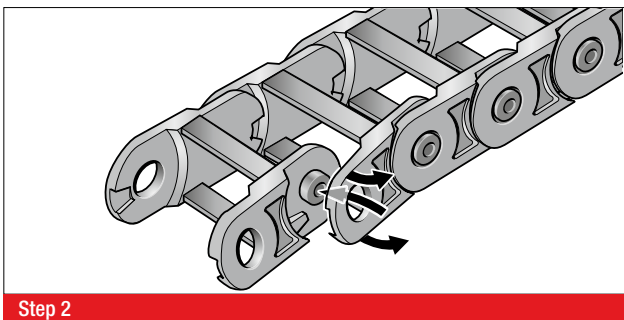
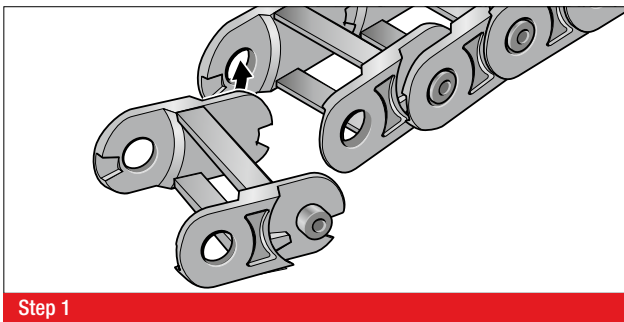

DISASSEMBLY

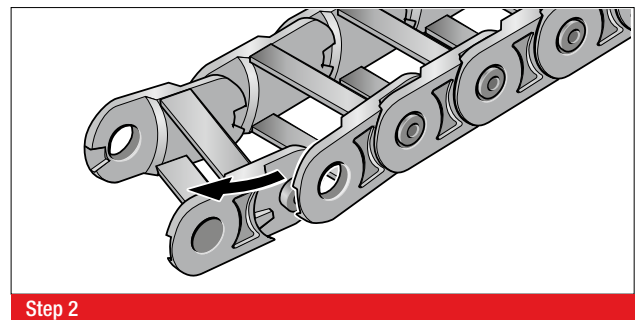
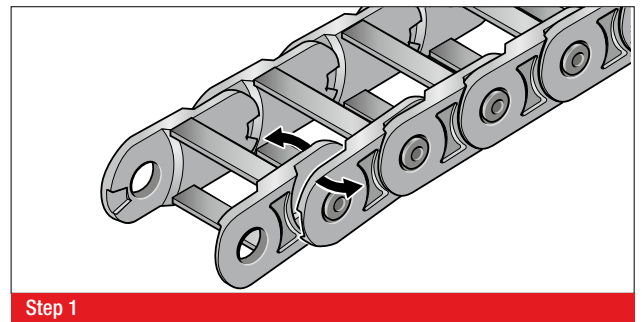

MP 20 OPEN



- LOW-COST VARIANT
- CHAIN BRACKET WITH INTEGRATED STRAIN RELIEF
- CROSSBAR WITH INTEGRAL HINGE

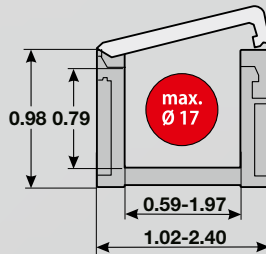

TECHNICAL DATA

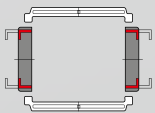

Loading side
Inside bend

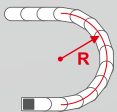

Available radii
1.5 – 4.92 inch

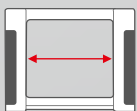

Available interior widths
With plastic crossbar
0.59 – 1.97 inch

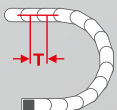

Grid
T = 1.38 inch



TECHNICAL SPECIFICATIONS

Travel distance gliding L_g max.	not recommended
Travel distance self-supporting L_r max.	see diagram on page 95
Travel distance vertical, hanging L_{vh} max.	26.25 ft.
Travel distance vertical, upright L_{vs} max.	9.84 ft.
Rotated 90°, unsupported L_{90f} max.	1.64 ft.
Speed, self-supporting V_f max.	32.81 ft/s
Acceleration, self-supporting a max.	32.81 ft/s ²

Contact our engineering department to meet any higher requirements: efk@murrplastik.de



MATERIAL PROPERTIES

Standard material	Polyamide (PA) black
Service temperature	-22.00 – 248.00 °F
Gliding friction factor	0.30
Static friction factor	0.45
Fire classification	UL 94 HB

Other material properties on request

CHAIN BRACKET

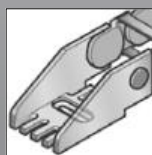

Chain bracket U-part

SHELVING SYSTEM

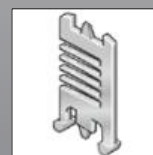

Separator TR

GUIDE CHANNELS



VAW aluminum

ORDERING KEY

Dimensions in mm [US inch]

Type code	Variation	Inside width	Outside width	Inside width	Outside width	Radius	Rail variant	Material	Chain length
0202 02	Crossbar on outside bend Crossbar on inside bend Opens on inside of bend	015¹⁾ [0.59]	026 [1.02]			038 [1.50]	0 Plastic, full-ridged with bias	0 Polyamide (PA): standard (PA/black)	
		025 [0.98]	036 [1.42]						
		038 [1.50]	049 [1.93]			048 [1.89]			
		050 [1.97]	061 [2.40]			075 [2.95]			
						100 [3.94]			
						125 [4.92]			

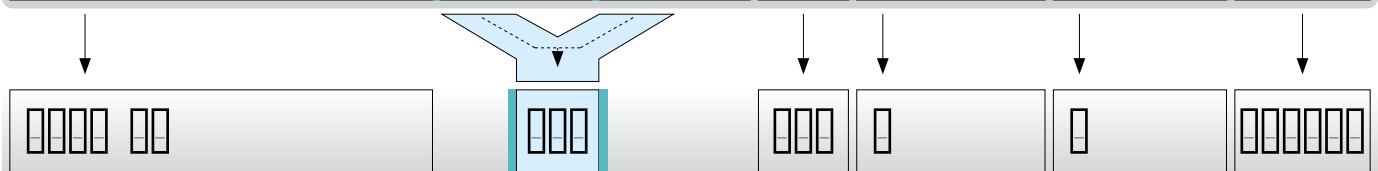

ORDERING EXAMPLE: 0202 02 025 048 0 0 770

Crossbar in inside and outside bend; can be opened in outside bend
 Inside width 0.98 in. (25 mm); radius 1.89 in. (48 mm)
 Full-ridged with bias, material black-colored polyamide
 Chain length 30.31 in. (770 mm) (22 links)

¹⁾ max. line diameter 0.51 in. (13.00 mm)

SELF-SUPPORTING LENGTH

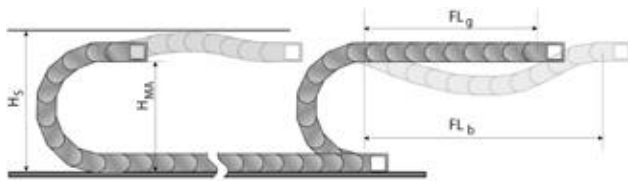

The self-supporting length is the distance between the chain bracket on the moving end and the start of the chain arch.
 The installation variant FL_g offers the lowest load and wear for the cable drag chain.
 The maximum travel parameters (speed and acceleration) can be applied for this variant.

- H_S = Installation height plus safety
- H_{MA} = Height of moving end connection
- FL_g = Self-supporting length, upper run straight
- FL_b = Self-supporting length, upper run bent

LOAD DIAGRAM FOR SELF-SUPPORTING APPLICATIONS

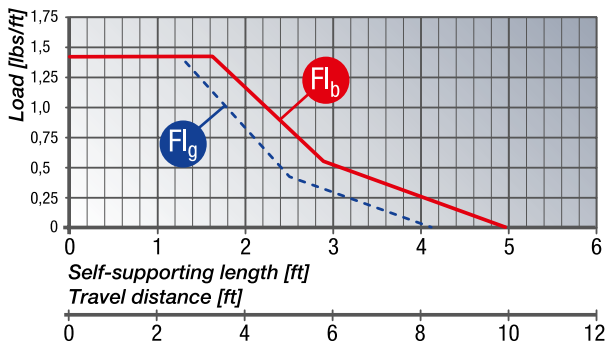

FL_g Self-supporting length, upper run straight

In the FL_g range, the chain upper run still has a bias, is straight or has a maximum sag of 1.57 inch.

FL_b Self-supporting length, upper run bent

In the FL_b range, the chain upper run has a sag of more than 1.57 inch, but this is still less than the maximum sag. Where the sag is greater than that permitted in the FL_b range, the application is critical and should be avoided. The self-supporting length can be optimized by using a support for the upper run or a more stable cable drag chain.

DETERMINING THE CHAIN LENGTH

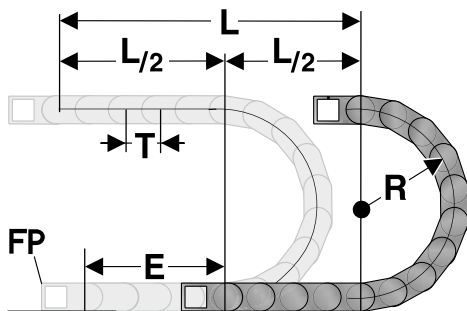

The fixed point of the cable drag chain should be connected in the middle of the travel distance.
 This arrangement gives the shortest connection between the fixed point and the moving bracket and thus the most efficient chain length.

Chain length calculation = $L/2 + \pi * R + 2 * T + E$
 $\approx 1 \text{ ft chain} = 9 \text{ qty.} \times 1.38 \text{ inch.}$

- E = Distance between entry point and middle of travel distance
- L = Travel distance
- R = Radius
- P = Grid 1.38 inch

INSTALLATION DIMENSIONS

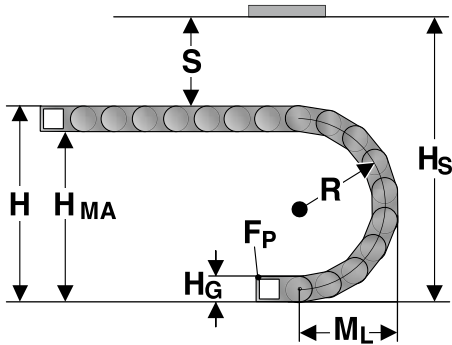

The moving end chain connection is to be screw fixed at height H_{MA} for the respective radius.
For the installed dimension the “Installed height H_s ” value has to be taken into account.

Radius R	1.50	1.89	2.95	3.94	4.92
Outside height of chain link (H_G)	0.98	0.98	0.98	0.98	0.98
Height of bend (H)	3.98	4.76	6.88	8.86	10.82
Height of moving end connection (H_{MA})	3.00	3.78	5.90	7.88	9.84
Safety margin (S)	0.79	0.79	0.79	0.79	0.79
Installation height (H_s)	4.77	5.55	7.67	9.65	11.61
Arc projection (M_L)	3.37	3.76	4.82	5.81	6.79

KA 20 CHAIN BRACKET U-PART

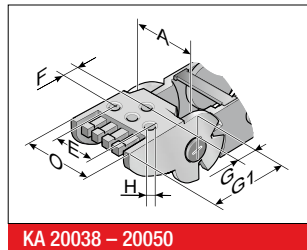
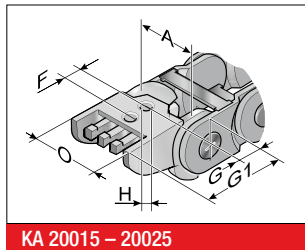

The chain bracket is an all-plastic part. The bracket is precisely adjusted to the respective chain width and only needs to be snapped in at the chain link. Please order one male and one female end bracket for each chain. The brackets should be fastened with M5 screws. The cables or conduits may be fastened with cable ties on the integrated strain relief of the chain bracket.

Type	Order No.	Material	Inside width						Outside width of KA O inch
			A inch	E inch	F inch	G inch	G1 inch	HØ inch	
KA 20015 Female end	020200005000	Plastic	0.59		0.75	0.65	1.65	0.22	A+0.43
KA 20015 Male end	020200005100	Plastic	0.59		0.75	0.65	1.65	0.22	A+0.43
KA 20025 Female end	020200005200	Plastic	0.98		0.75	0.65	1.65	0.22	A+0.43
KA 20025 Male end	020200005300	Plastic	0.98		0.75	0.65	1.65	0.22	A+0.43
KA 20038 Female end	020200005400	Plastic	1.50	A-0.71	0.75	0.65	1.65	0.22	A+0.43
KA 20038 Male end	020200005500	Plastic	1.50	A-0.71	0.75	0.65	1.65	0.22	A+0.43
KA 20050 Female end	020200005600	Plastic	1.97	A-0.63	0.75	0.65	1.65	0.22	A+0.43
KA 20050 Male end	020200005700	Plastic	1.97	A-0.63	0.75	0.65	1.65	0.22	A+0.43

TR 20 SEPARATOR

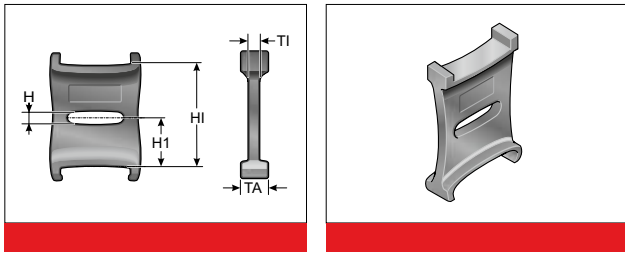

We recommend that separators be used if multiple round cables or conduits with differing diameters are to be installed.

Type	Order No.	Description	Version	TI inch	TA inch	H inch	H1 inch	H2 inch
TR 20	020000009000	Separator	movable	0.06	0.31	0.10	0.39	0.39

VAW GUIDE CHANNEL



A variable guide channel system, constructed from aluminum sections, is available for this cable drag chain. The variable guide channel ensures that the cable drag chain is supported and guided securely.

ASSEMBLY

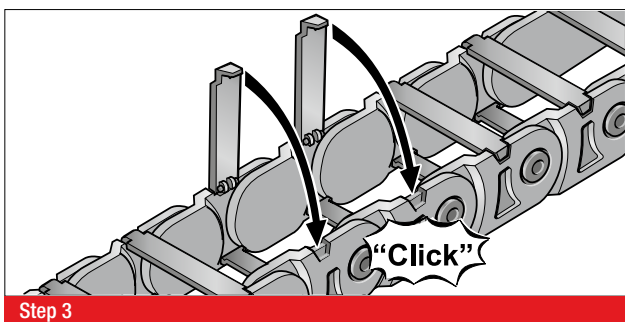
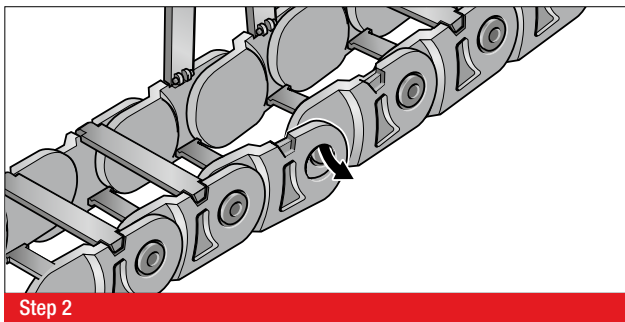

DISASSEMBLY

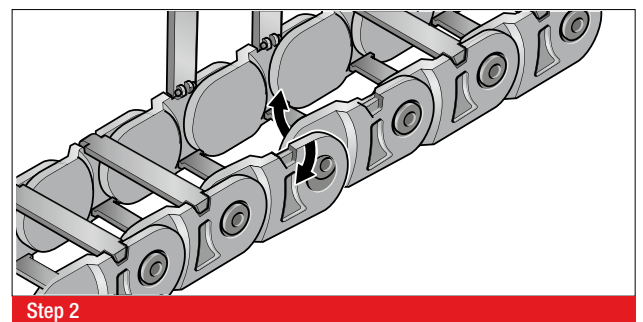
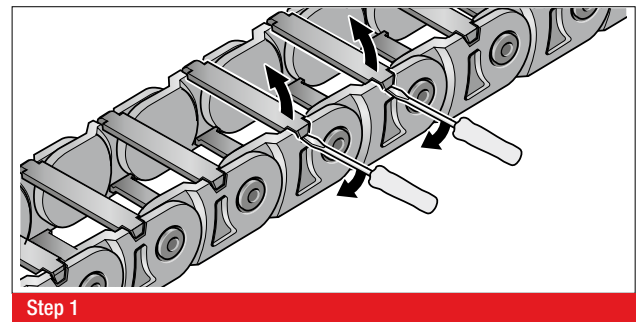

MP 3000 OPEN



- LOW-COST VARIANT
- CHAIN BRACKET WITH INTEGRATED STRAIN RELIEF

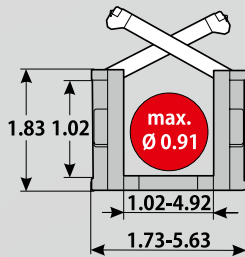

TECHNICAL DATA

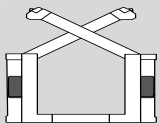

Loading side
Inside bend

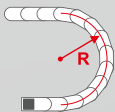

Available radii
1.97 – 11.81 inch

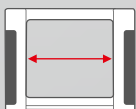

Available interior widths
With plastic crossbar
1.02 – 4.92 inch

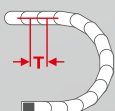

Grid
T = 1.77 inch

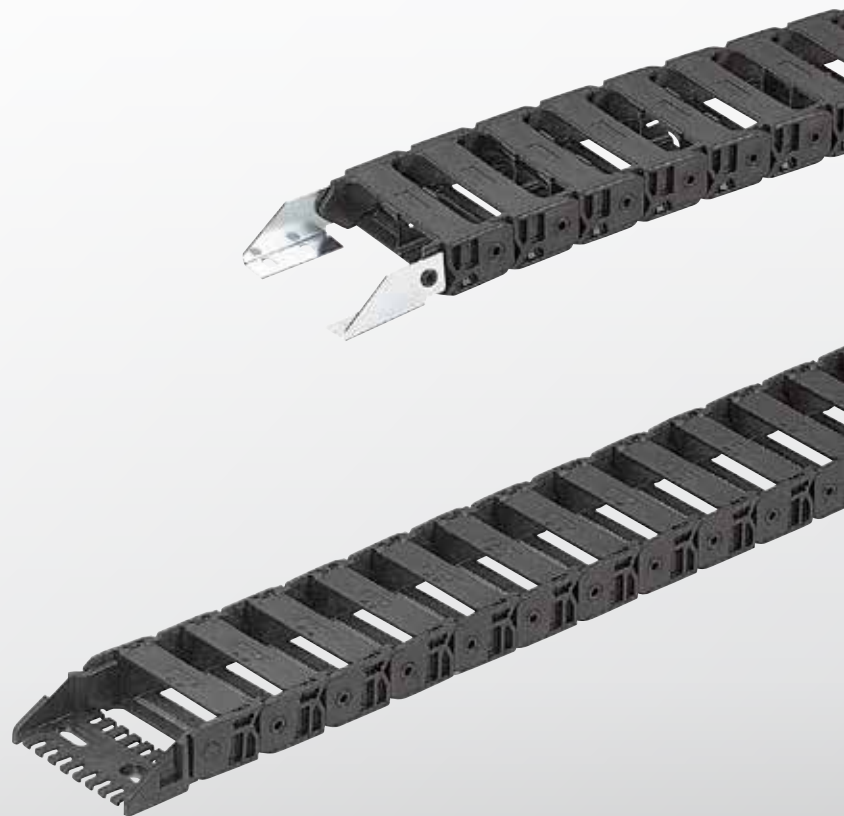

TECHNICAL SPECIFICATIONS

Travel distance gliding L_g max.	196.85 ft.
Travel distance self-supporting L_s max.	see diagram on page 101
Travel distance vertical, hanging L_{vh} max.	131.23 ft.
Travel distance vertical, upright L_{vs} max.	9.84 ft.
Rotated 90°, unsupported L_{90f} max.	2.30 ft.
Speed, gliding V_g max.	9.84 ft/s
Speed, self-supporting V_s max.	19.69 ft/s
Acceleration, gliding a_g max.	32.81 ft/s ²
Acceleration, self-supporting a_s max.	49.21 ft/s ²

Contact our engineering department to meet any higher requirements: efk@murrplastik.de



MATERIAL PROPERTIES

Standard material	Polyamide (PA) black
Service temperature	-22.00 – 248.00 °F
Gliding friction factor	0.30
Static friction factor	0.45
Fire classification	UL 94 HB

Other material properties on request

SHELVING SYSTEM

CHAIN BRACKET

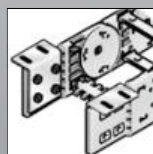

Chain bracket angle

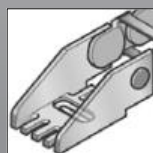

Chain bracket U-part

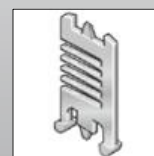

Separator TR



RS shelving system



H-shaped shelf unit RE

GUIDE CHANNELS



VAW steel galvanized / stainless steel



VAW aluminum

ORDERING KEY

Dimensions in mm [US inch]

Type code	Variation	Inside width	Outside width	Inside width	Outside width	Radius	Rail variant	Material	Chain length
0300 02	Crossbar on outside bend Crossbar on inside bend Opens on inside of bend	026 [1.02]	044 [1.73]			050 [1.97]	0 Plastic, full-ridged with bias	0 Polyamide (PA): standard (PA/black)	
		037 [1.46]	055 [2.17]						
		056 [2.20]	074 [2.91]						
		062 [2.44]	080 [3.15]			070 [2.76]	1 Plastic, full-ridged without bias	1 UL94 / V0 (PA/oxide red)	
		076 [2.99]	094 [3.70]			095 [3.74]		5 Polypropylene (PP/blue)	
		087 [3.43]	105 [4.13]						
		101 [3.98]	119 [4.69]			120 [4.72]		7 ESD (PA/light gray)	
		125 [4.92]	143 [5.63]						
						150 [5.91]		9 Special version (on request)	
						200 [7.87]			
						300 [11.81]			

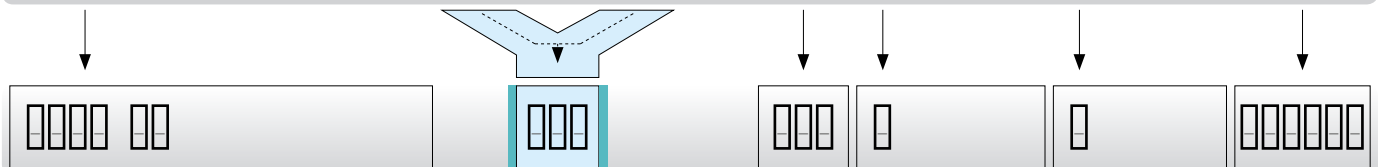

ORDERING EXAMPLE: 0300 026 050 0 0 000047

Crossbar on outside bend, crossbar on inside bend, can be opened from inside bend
 Inside width 1.02 in.; radius 1.97 in.
 Plastic crossbar, full-ridged with bias, material black-colored polyamide
 Chain length 47 in. (27 links)

SELF-SUPPORTING LENGTH

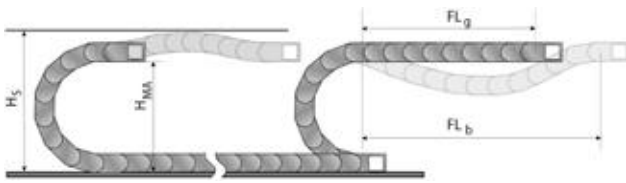

The self-supporting length is the distance between the chain bracket on the moving end and the start of the chain arch.
 The installation variant FL_g offers the lowest load and wear for the cable drag chain.
 The maximum travel parameters (speed and acceleration) can be applied for this variant.

- H_s = Installation height plus safety
- H_{MA} = Height of moving end connection
- FL_g = Self-supporting length, upper run straight
- FL_b = Self-supporting length, upper run bent

LOAD DIAGRAM FOR SELF-SUPPORTING APPLICATIONS

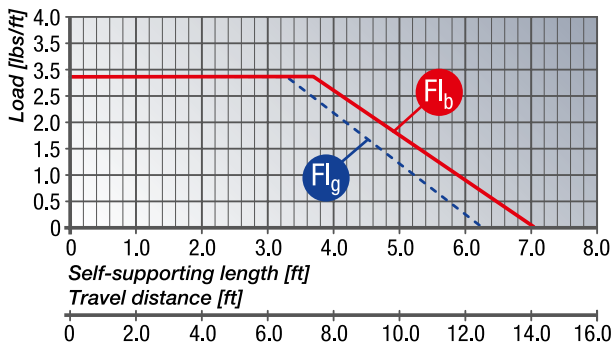

FL_g Self-supporting length, upper run straight
 In the FL_g range, the chain upper run still has a bias, is straight or has a maximum sag of 2.36 inch.

FL_b Self-supporting length, upper run bent
 In the FL_b range, the chain upper run has a sag of more than 2.36 inch, but this is still less than the maximum sag. Where the sag is greater than that permitted in the FL_b range, the application is critical and should be avoided. The self-supporting length can be optimized by using a support for the upper run or a more stable cable drag chain.

DETERMINING THE CHAIN LENGTH

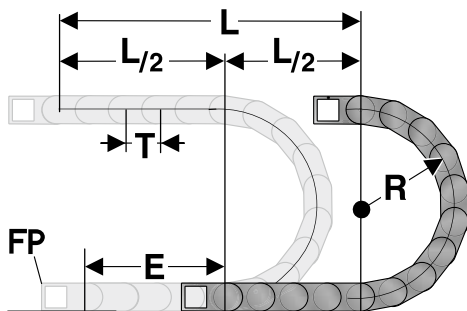

The fixed point of the cable drag chain should be connected in the middle of the travel distance.
 This arrangement gives the shortest connection between the fixed point and the moving bracket and thus the most efficient chain length.

Chain length calculation = $L/2 + \pi * R + 2 * T + E$
 $\approx 1 \text{ ft chain} = 7 \text{ qty.} \times 1.77 \text{ inch.}$

- E = Distance between entry point and middle of travel distance
- L = Travel distance
- R = Radius
- P = Grid 1.77 inch

INSTALLATION DIMENSIONS

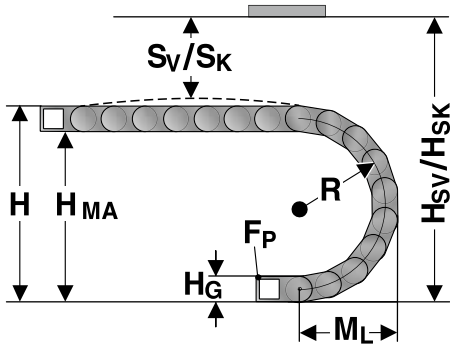

The moving end chain connection is to be screw fixed at height H_{MA} for the respective radius.

Concerning the installed dimensions, you must take into account whether the chain links are equipped with or without bias. For chain links without bias, the “Installed height without bias H_{SK} ” value has to be taken into account.

If the chain links are equipped with a bias, the value “Installed height with bias H_{SV} ” has to be taken into account.

Radius R	1.97	2.76	3.74	4.72	5.91	7.87	11.81
Outside height of chain link (H_G)	1.38	1.38	1.38	1.38	1.38	1.38	1.38
Height of bend (H)	5.32	6.90	8.86	10.82	13.20	17.12	25.00
Height of moving end connection (H_{MA})	3.94	5.52	7.48	9.44	11.82	15.74	23.62
Safety margin with bias (S_V)	1.77	1.77	1.77	1.77	1.77	1.77	1.77
Installation height with bias (H_{SV})	7.09	8.67	10.63	12.59	14.97	18.89	26.77
Safety margin without bias (S_K)	0.39	0.39	0.39	0.39	0.39	0.39	0.39
Installation height without bias (H_{SK})	5.71	7.29	9.25	11.21	13.59	17.51	25.39
Arc projection (M_L)	4.43	5.22	6.20	7.18	8.37	10.33	14.27

KA 3000 CHAIN BRACKET ANGLE

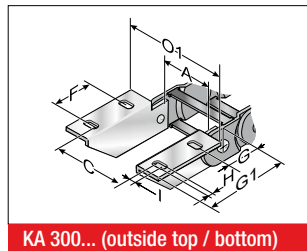
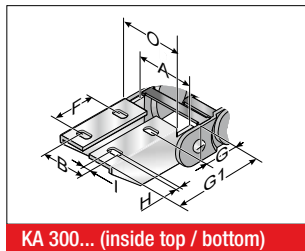

The chain bracket can be supplied either in galvanized sheet steel or stainless steel. To secure one cable drag chain, you will need two angle brackets (left and right) with a drilled hole and two angle brackets (left and right) with a bolt. The Order No.s given below each comprise a left and right angle bracket.

Type	Order No.	Material	Inside width								Outside width of KA 0	Outside width of KA 01
			A inch	B inch	C inch	F inch	G inch	G1 inch	HØ inch	I inch		
KA 3008 Female end	0300000052	Sheet steel	1.02 – 4.92	A-0.33	A+0.89	0.98	0.83	2.28	0.26	0.18	A+0.71	A+1.57
KA 3008 Male end	0300000053	Sheet steel	1.02 – 4.92	A-0.14	A+1.22	0.98	0.83	2.24	0.26	0.18	A+0.35	A+1.57
KA 3009 Female end	0300000054	Stainless steel 1.4301	1.02 – 4.92	A-0.33	A+0.89	0.98	0.83	2.28	0.26	0.18	A+0.71	A+1.57
KA 3009 Male end	0300000055	Stainless steel 1.4301	1.02 – 4.92	A-0.14	A+1.22	0.98	0.83	2.24	0.26	0.18	A+0.35	A+1.57

KA 3000 CHAIN BRACKET U-PART

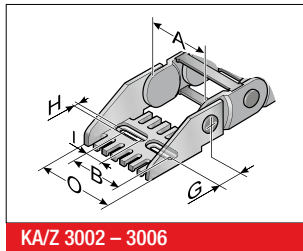
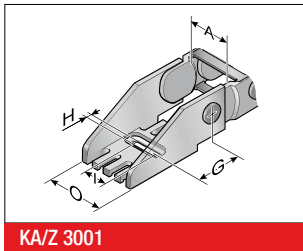

The type KA/Z 3001 – 3006 chain bracket is a plastic part with an extrusion-coated metal insert. The bracket is precisely adjusted to the respective chain width and only needs to be snapped in at the chain link. Please order one male and one female end bracket for each chain. The brackets should be fastened with M6 screws. The cables or tubes may be fastened with cable ties at the integrated strain relief of the chain bracket.

Type	Order No.	Material	Inside width					Outside width of KA 0 inch
			A inch	B inch	G inch	HØ inch	I inch	
KA/Z 3001 Female end	030000008000	Relief plate with metal inserts	1.02		1.24	0.26	0.73	A+0.71
KA/Z 3001 male end	030000008100	Relief plate with metal inserts	1.02		1.24	0.26	0.73	A+0.71
KA/Z 3002 Female end	030000008200	Relief plate with metal inserts	1.46	A-0.28	1.24	0.26	0.30	A+0.71
KA/Z 3002 male end	030000008300	Relief plate with metal inserts	1.46	A-0.28	1.24	0.26	0.30	A+0.71
KA/Z 3002.5 Female end	030000007600	Relief plate with metal inserts	2.20	A-0.31	1.24	0.26	0.30	A+0.71
KA/Z 3002.5 male end	030000007700	Relief plate with metal inserts	2.20	A-0.31	1.24	0.26	0.30	A+0.71
KA/Z 3003 Female end	030000008400	Relief plate with metal inserts	2.44	A-0.28	1.24	0.26	0.73	A+0.71
KA/Z 3003 male end	030000008500	Relief plate with metal inserts	2.44	A-0.28	1.24	0.26	0.73	A+0.71
KA/Z 3003.5 Female end	030000007800	Relief plate with metal inserts	2.99	A-0.31	1.24	0.26	0.73	A+0.71
KA/Z 3003.5 male end	030000007900	Relief plate with metal inserts	2.99	A-0.31	1.24	0.26	0.73	A+0.71
KA/Z 3004 Female end	030000008600	Relief plate with metal inserts	3.43	A-0.28	1.24	0.26	0.73	A+0.71
KA/Z 3004 male end	030000008700	Relief plate with metal inserts	3.43	A-0.28	1.24	0.26	0.73	A+0.71
KA/Z 3005 Female end	030000008800	Relief plate with metal inserts	3.98	A-0.28	1.24	0.26	0.73	A+0.71
KA/Z 3005 male end	030000008900	Relief plate with metal inserts	3.98	A-0.28	1.24	0.26	0.73	A+0.71
KA/Z 3006 Female end	030000009300	Relief plate with metal inserts	4.92	A-0.26	1.24	0.26	0.73	A+0.71
KA/Z 3006 male end	030000009400	Relief plate with metal inserts	4.92	A-0.26	1.24	0.26	0.73	A+0.71

MP 3000 SEPARATOR

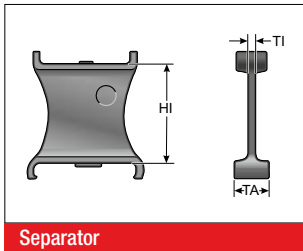

Separator

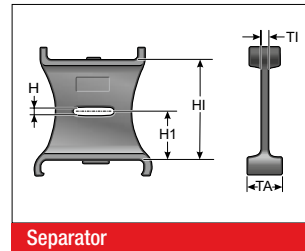
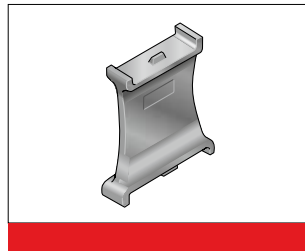

Separator

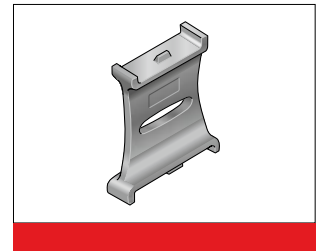

We recommend that separators be used if multiple round cables or conduits with differing diameters are to be installed. For

cable drag chains that need to be side mounted, the lockable (unmovable) separator must be used.

Type	Order No.	Description	Version	TI inch	TA inch	H inch	H1 inch	H2 inch	HI inch
TR 3000	030000009000	Separator	movable	0.06	0.51	0.10	0.51	0.51	1.02
TR 3001	030000009200	Separator	lockable	0.06	0.51	0.10	0.51	0.51	1.02
TR 3002	030000009500	Separator, closed	lockable	0.06	0.51				1.02

MP 3000 SHELVING SYSTEM

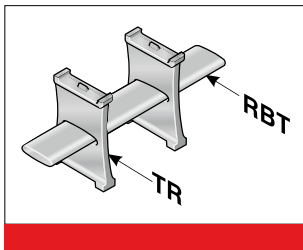

The shelf must be used with a minimum of two separators to create a shelving system. The additional levels prevent cables from criss-crossing and minimize the friction between them. The shelves are matched to the available chain widths.

Type	Order No.	Description	Width inch	Lock grid spacing inch
RBT 037	100000003700	Shelf	1.46	0.12
RBT 062	100000006200	Shelf	2.44	0.12
RBT 086	100000008600	Shelf	3.39	0.12
RBT 101	100000010100	Shelf	3.98	0.12
RBT 125	100000012500	Shelf	4.92	0.12

RE 26 H-SHAPED SHELF UNIT

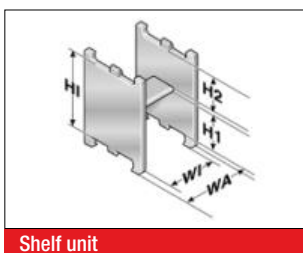

Shelf unit

One-piece shelving system, the shelf cannot be varied in height.

Type	Order No.	Description	WA inch	WI inch	H1 inch	H2 inch	HI inch
RE 26/15	100000261510	H-shaped shelf unit	0.69	0.49	0.54	0.38	1.02
RE 26/27	100000262710	H-shaped shelf unit	1.16	0.96	0.54	0.38	1.02
RE 26/32	100000263210	H-shaped shelf unit	1.36	1.16	0.54	0.38	1.02
RE 26/51	100000265110	H-shaped shelf unit	2.11	1.91	0.54	0.38	1.02

GUIDE CHANNEL VAW (ALUMINUM / STAINLESS STEEL)



A range of variable guide channel systems, constructed from aluminum or stainless steel sections, is available for this cable drag chain.

The variable guide channel ensures that the cable drag chain is supported and guided securely.

ASSEMBLY

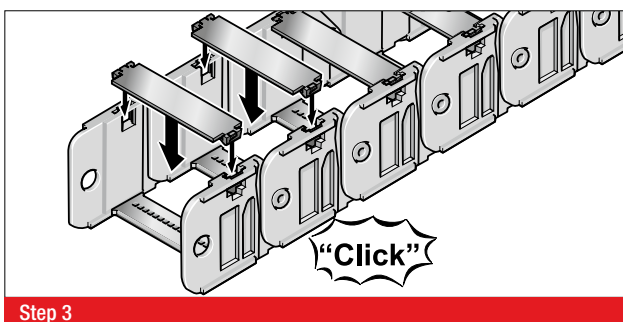
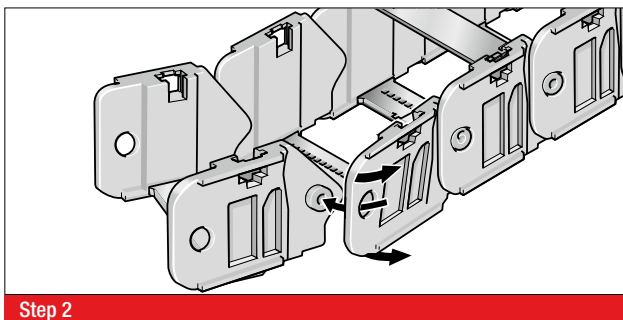
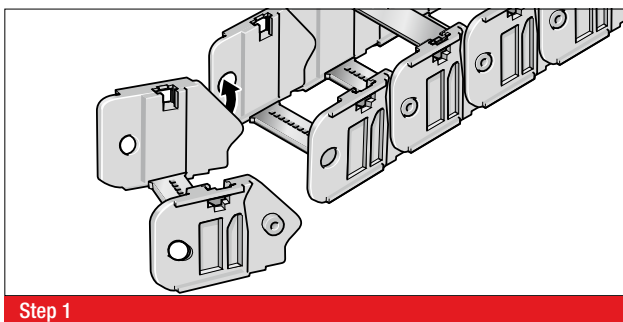

DISASSEMBLY

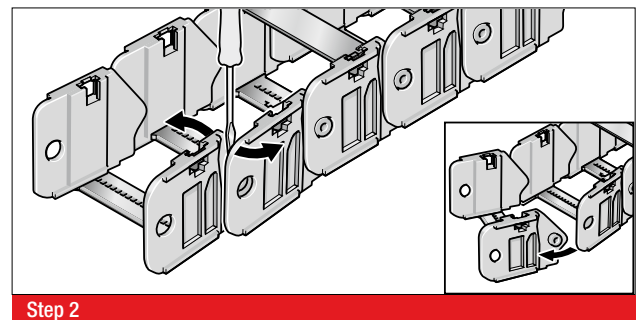
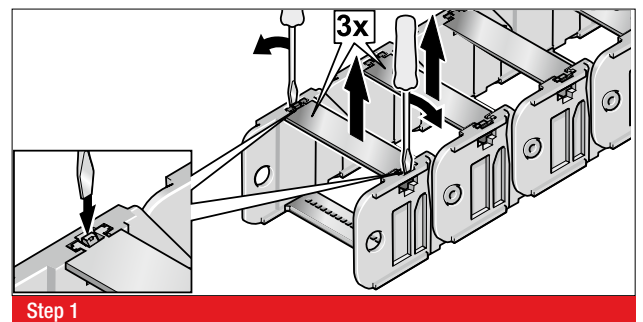

MP 25G CLOSED



- CLOSED VARIANTS, STARTING WITH R60
- COMPACT DESIGN

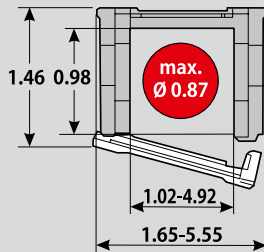

TECHNICAL DATA

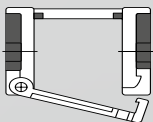

Loading side
Outside bend

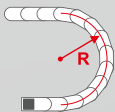

Available radii
2.36 – 9.84 inch

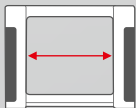

Available interior widths
With plastic crossbar
1.02 – 4.92 inch

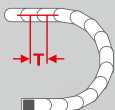

Grid
T = 1.18 inch

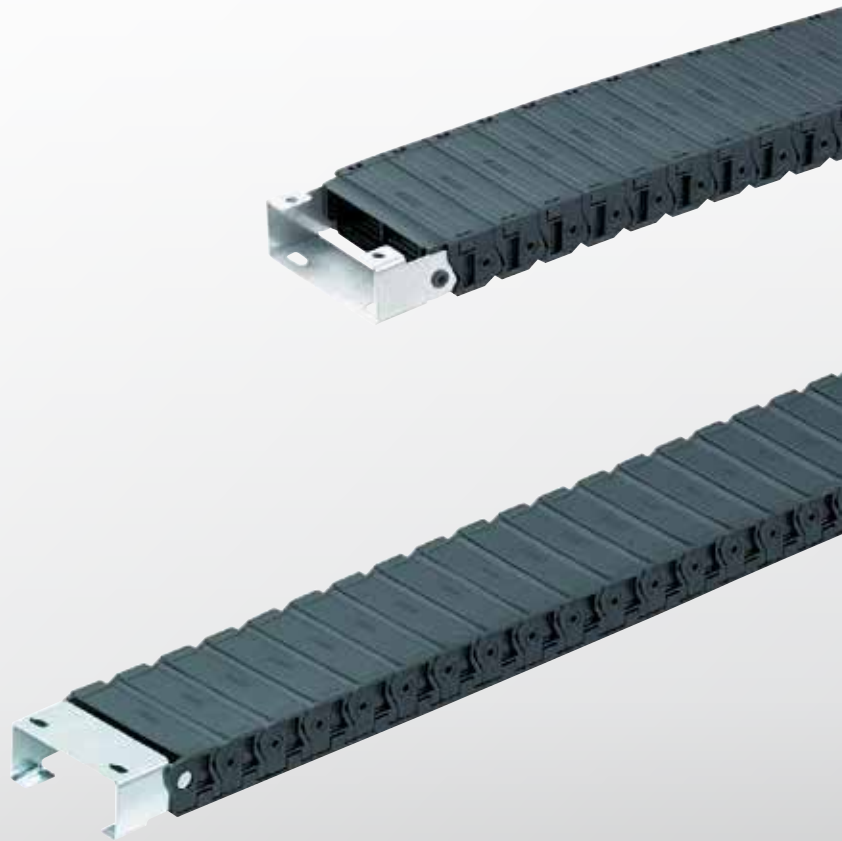

TECHNICAL SPECIFICATIONS

Travel distance gliding L_g max.	131.23 ft.
Travel distance self-supporting L_r max.	see diagram on page 109
Travel distance vertical, hanging L_{vh} max.	82.02 ft.
Travel distance vertical, upright L_{vs} max.	9.84 ft.
Rotated 90°, unsupported L_{90f} max.	3.28 ft.
Speed, gliding V_g max.	9.84 ft/s
Speed, self-supporting V_f max.	19.69 ft/s
Acceleration, gliding a_g max.	32.81 ft/s ²
Acceleration, self-supporting a_f max.	49.21 ft/s ²

Contact our engineering department to meet any higher requirements: efk@murrplastik.de



MATERIAL PROPERTIES

Standard material	Polyamide (PA) black
Service temperature	-22.00 – 248.00 °F
Gliding friction factor	0.30
Static friction factor	0.45
Fire classification	Based on UL 94 HB

Other material properties on request

SHELVING SYSTEM

GUIDE CHANNELS

CHAIN BRACKET



Separator TR



VAW steel galvanized / stainless steel

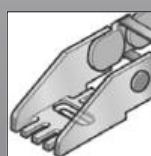

Chain bracket U-part



RS shelving system



VAW aluminum

ORDERING KEY

Dimensions in mm [US inch]

Type code	Variation	Inside width	Outside width	Inside width	Outside width	Radius	Rail variant	Material	Chain length
0250 03	Cover on outside of bend Cover on inside of bend Opens on outside bend	026 [1.02]	042 [1.65]			060 [2.36]	0 Plastic, full-ridged with bias	0 Polyamide (PA): standard (PA/black)	
		037 [1.46]	053 [2.09]						
		062 [2.44]	078 [3.07]			075 [2.95]		7 ESD (PA/light gray)	
		087 [3.43]	103 [4.06]						
		101 [3.98]	117 [4.61]			100 [3.94]		9 Special version (on request)	
		125 [4.92]	141 [5.55]						
						125 [4.92]			
						150 [5.91]			
						200 [7.87]			
						250 [9.84]			

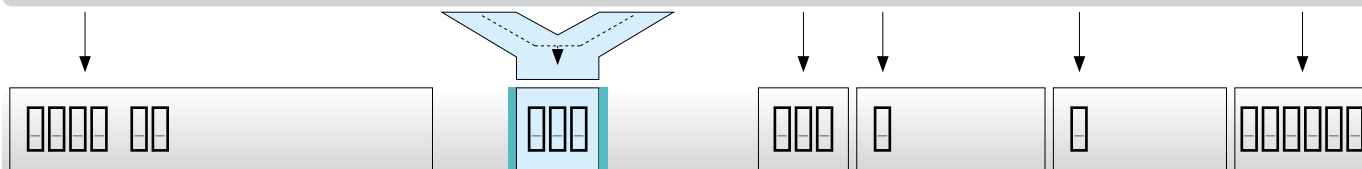

ORDERING EXAMPLE: 0250 026 060 0 0 000048

Cover in outside bend, cover in inside bend, can be opened from outside bend
 Inside width 1.02 in.; radius 2.36 in.
 Plastic crossbar, full-ridged with bias, material black-colored polyamide
 Chain length 48 in. (41 links)

SELF-SUPPORTING LENGTH

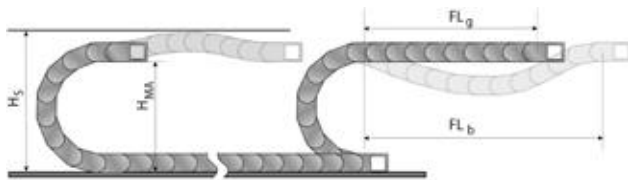

The self-supporting length is the distance between the chain bracket on the moving end and the start of the chain arch.
 The installation variant FL_g offers the lowest load and wear for the cable drag chain.
 The maximum travel parameters (speed and acceleration) can be applied for this variant.

- H_S = Installation height plus safety
- H_{MA} = Height of moving end connection
- FL_g = Self-supporting length, upper run straight
- FL_b = Self-supporting length, upper run bent

LOAD DIAGRAM FOR SELF-SUPPORTING APPLICATIONS

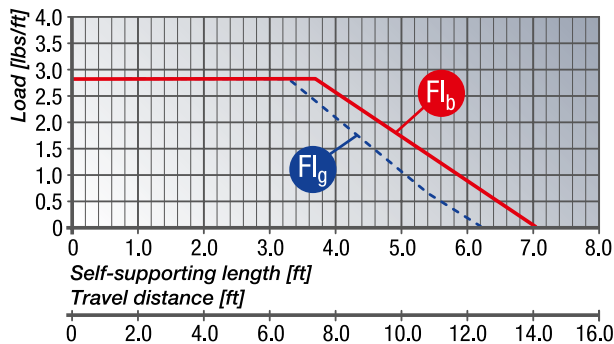

FL_g Self-supporting length, upper run straight
 In the FL_g range, the chain upper run still has a bias, is straight or has a maximum sag of 2.36 inch.

FL_b Self-supporting length, upper run bent
 In the FL_b range, the chain upper run has a sag of more than 2.36 inch, but this is still less than the maximum sag. Where the sag is greater than that permitted in the FL_b range, the application is critical and should be avoided. The self-supporting length can be optimized by using a support for the upper run or a more stable cable drag chain.

DETERMINING THE CHAIN LENGTH

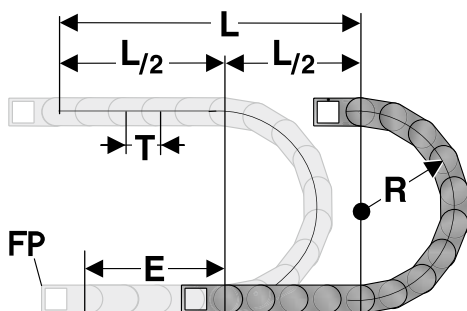

The fixed point of the cable drag chain should be connected in the middle of the travel distance.
 This arrangement gives the shortest connection between the fixed point and the moving bracket and thus the most efficient chain length.

Chain length calculation = $L/2 + \pi * R + 2 * T + E$
 $\approx 1 \text{ ft chain} = 11 \text{ qty.} \times 1.18 \text{ inch.}$

- E = Distance between entry point and middle of travel distance
- L = Travel distance
- R = Radius
- P = Grid 1.18 inch

INSTALLATION DIMENSIONS

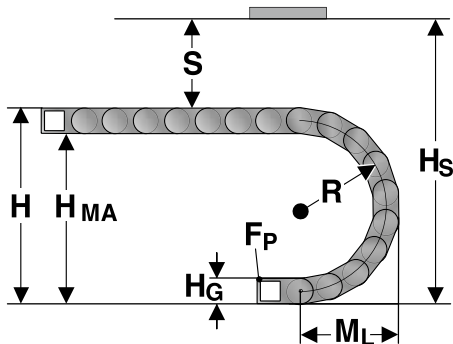

The moving end chain connection is to be screw fixed at height H_{MA} for the respective radius.
For the installed dimension the "Installed height H_S " value has to be taken into account.

Radius R	2.36	2.95	3.94	4.92	5.91	7.87	9.84
Outside height of chain link (H_G)	1.46	1.46	1.46	1.46	1.46	1.46	1.46
Height of bend (H)	6.18	7.36	9.34	11.30	13.28	17.20	21.14
Height of moving end connection (H_{MA})	4.72	5.90	7.88	9.84	11.82	15.74	19.68
Safety margin (S)	1.30	1.30	1.30	1.30	1.30	1.30	1.30
Installation height (H_S)	7.48	8.66	10.64	12.60	14.58	18.50	22.44
Arc projection (M_L)	4.27	4.86	5.85	6.83	7.82	9.78	11.75

KA 25 G CHAIN BRACKET U-PART

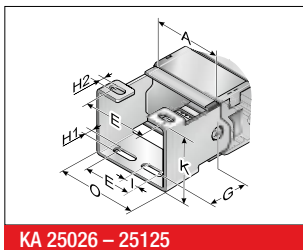

The chain bracket can be supplied either in galvanized sheet steel or stainless steel. To secure one cable drag chain, you will need a bracket with a drilled hole and a bracket with a bolt.

KA 25026 – 25125

Type	Order No.	Material	Inside width							Outside width of KA 0
			A inch	E inch	G inch	H1 inch	H2 inch	I inch	K inch	
KA 25026 C Female end	025000001000	Sheet steel	1.02	A-0.39	1.65	0.26	0.26	0.26	1.42	A+0.43
KA 25026 C Male end	025000001100	Sheet steel	1.02	A-0.39	1.65	0.26	0.26	0.26	1.42	A+0.31
KA 25037 C Female end	025000001200	Sheet steel	1.46	A-0.39	1.65	0.26	0.26	0.26	1.42	A+0.43
KA 25037 C Male end	025000001300	Sheet steel	1.46	A-0.39	1.65	0.26	0.26	0.26	1.42	A+0.31
KA 25062 C Female end	025000001400	Sheet steel	2.44	A-0.39	1.65	0.26	0.26	0.26	1.42	A+0.43
KA 25062 C Male end	025000001500	Sheet steel	2.44	A-0.39	1.65	0.26	0.26	0.26	1.42	A+0.31
KA 25087 C Female end	025000001600	Sheet steel	3.43	A-0.39	1.65	0.26	0.26	0.26	1.42	A+0.43
KA 25087 C Male end	025000001700	Sheet steel	3.43	A-0.39	1.65	0.26	0.26	0.26	1.42	A+0.31
KA 25101 C Female end	025000001800	Sheet steel	3.98	A-0.39	1.65	0.26	0.26	0.26	1.42	A+0.43
KA 25101 C Male end	025000001900	Sheet steel	3.98	A-0.39	1.65	0.26	0.26	0.26	1.42	A+0.31
KA 25125 C Female end	025000002000	Sheet steel	4.92	A-0.39	1.65	0.26	0.26	0.26	1.42	A+0.43
KA 25125 C Male end	025000002100	Sheet steel	4.92	A-0.39	1.65	0.26	0.26	0.26	1.42	A+0.31
KA 25026 C Female end	025000003000	Stainless steel 1.4301	1.02	A-0.39	1.65	0.26	0.26	0.26	1.42	A+0.43
KA 25026 C Male end	025000003100	Stainless steel 1.4301	1.02	A-0.39	1.65	0.26	0.26	0.26	1.42	A+0.31
KA 25037 C Female end	025000003200	Stainless steel 1.4301	1.46	A-0.39	1.65	0.26	0.26	0.26	1.42	A+0.43

KA 25 G CHAIN BRACKET U-PART

Type	Order No.	Material	Inside width								Outside width of KA 0 inch
			A inch	E inch	G inch	H1 inch	H2 inch	I inch	K inch		
KA 25037 C Male end	025000003300	Stainless steel 1.4301	1.46	A-0.39	1.65	0.26	0.26	0.26	1.42	A+0.31	
KA 25062 C Female end	025000003400	Stainless steel 1.4301	2.44	A-0.39	1.65	0.26	0.26	0.26	1.42	A+0.43	
KA 25062 C Male end	025000003500	Stainless steel 1.4301	2.44	A-0.39	1.65	0.26	0.26	0.26	1.42	A+0.31	
KA 25087 C Female end	025000003600	Stainless steel 1.4301	3.43	A-0.39	1.65	0.26	0.26	0.26	1.42	A+0.43	
KA 25087 C Male end	025000003700	Stainless steel 1.4301	3.43	A-0.39	1.65	0.26	0.26	0.26	1.42	A+0.31	
KA 25101 C Female end	025000003800	Stainless steel 1.4301	3.98	A-0.39	1.65	0.26	0.26	0.26	1.42	A+0.43	
KA 25101 C Male end	025000003900	Stainless steel 1.4301	3.98	A-0.39	1.65	0.26	0.26	0.26	1.42	A+0.31	
KA 25125 C Female end	025000004000	Stainless steel 1.4301	4.92	A-0.39	1.65	0.26	0.26	0.26	1.42	A+0.43	
KA 25125 C Male end	025000004100	Stainless steel 1.4301	4.92	A-0.39	1.65	0.26	0.26	0.26	1.42	A+0.31	

TR 25G SEPARATOR

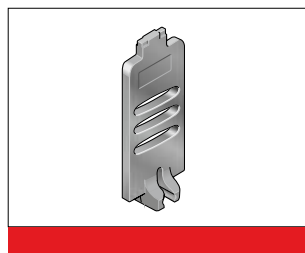
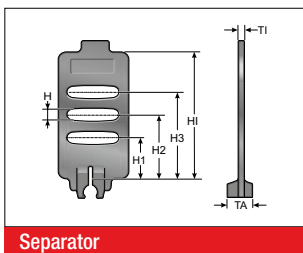

We recommend that separators be used if multiple round cables or conduits with differing diameters are to be installed.

Type	Order No.	Description	Version	TI inch	TA inch	H inch	H1 inch	H2 inch	H3 inch	HI inch
TR 25G	025000009200	Separator	lockable	0.08	0.31	0.10	0.33	0.50	0.68	0.98

MP 25G SHELVING SYSTEM



The shelf must be used with a minimum of two separators to create a shelving system. The additional levels prevent cables from criss-crossing and minimize the friction between them. The shelves are matched to the available chain widths.

Type	Order No.	Description	Width inch	Lock grid spacing inch
RBT 037	100000003700	Shelf	1.46	0.10
RBT 062	100000006200	Shelf	2.44	0.10
RBT 086	100000008600	Shelf	3.39	0.10
RBT 101	100000010100	Shelf	3.98	0.10
RBT 125	100000012500	Shelf	4.92	0.10

GUIDE CHANNEL VAW (ALUMINUM / STAINLESS STEEL)



A range of variable guide channel systems, constructed from aluminum or stainless steel sections, is available for this cable drag chain.

The variable guide channel ensures that the cable drag chain is supported and guided securely.

ASSEMBLY

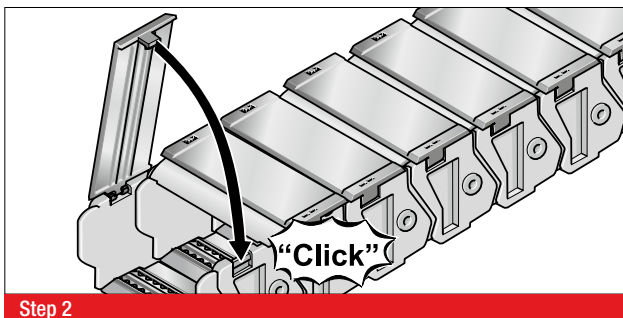
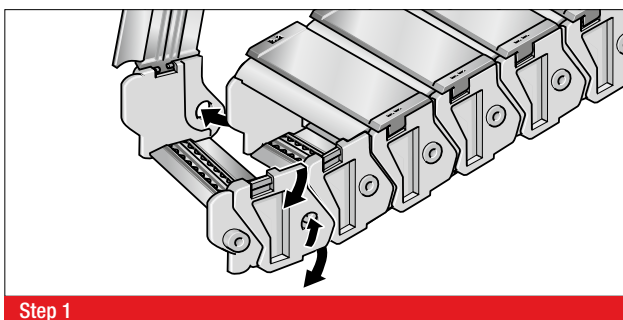

DISASSEMBLY

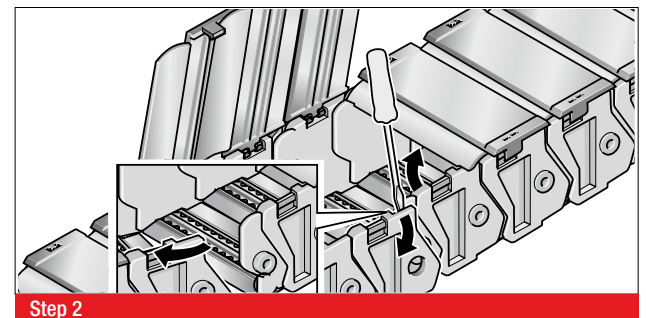
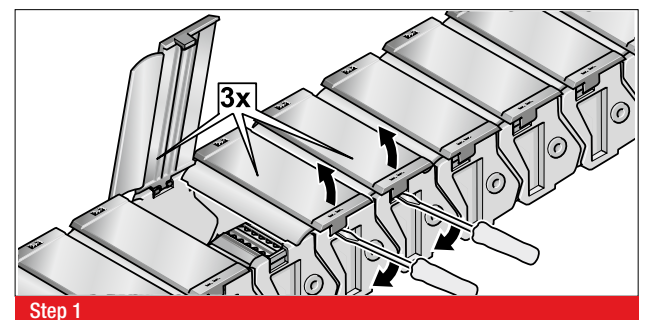

MP 35.1
OPEN



MP 35.2
OPEN



- LOW-COST VARIANT
- SOFT-STOP SYSTEM
- SUITABLE FOR UNIVERSAL USE
- CHAIN BRACKET WITH INTEGRATED STRAIN RELIEF
- EXTENSIVE AND EASY TO INSTALL INTERIOR LAYOUT

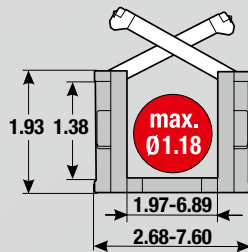

TECHNICAL DATA

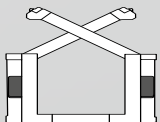

Loading side
Inside or outside bend

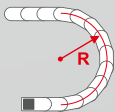

Available radii
63.0 – 250.0

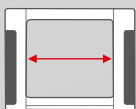

Available interior widths
With plastic crossbar
50.0 – 175.0

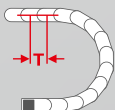

Grid
T = 2.20 inch



Noise attenuator



TECHNICAL SPECIFICATIONS

Travel distance gliding L_g max.	262.47 ft.
Travel distance self-supporting L_s max.	see diagram on page 117
Travel distance vertical, hanging L_{vh} max.	164.04 ft.
Travel distance vertical, upright L_{vs} max.	9.84 ft.
Rotated 90°, unsupported L_{90f} max.	3.28 ft.
Speed, gliding V_g max.	16.40 ft/s
Speed, self-supporting V_f max.	65.62 ft/s
Acceleration, gliding a_g max.	49.21 ft/s ²
Acceleration, self-supporting a_s max.	164.04 ft/s ²

Contact our engineering department to meet any higher requirements: efk@murrplastik.de



MATERIAL PROPERTIES

Standard material	Polyamide (PA) black
Service temperature	-22.00 – 248.00 °F
Gliding friction factor	0.30
Static friction factor	0.45
Fire classification	UL 94 HB

Other material properties on request

CHAIN BRACKET

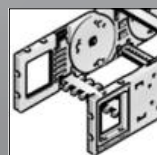

Chain bracket flexible

SHELVING SYSTEM

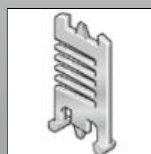

Separator TR

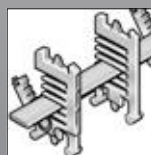

RS shelving system

GUIDE CHANNELS



VAW steel galvanized / stainless steel

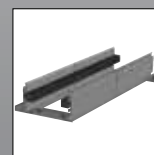

VAW aluminum

STRAIN RELIEF

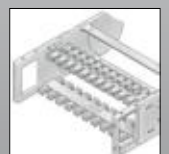

RS-ZL crossbar strain relief



STF Steel Fix

ORDERING KEY

Dimensions in mm [US inch]

Type code	Variation	Inside width	Outside width	Inside width	Outside width	Radius	Rail variant	Material	Chain length																																																																																																								
0351 01	MP 35.1 open Crossbar on outside bend Crossbar on inside bend Opens on outside bend	050 [1.97]	068 [2.68]			063 [2.48]	0 Plastic, full-ridged with bias	2 Polyamide without attenuator (PA/black)																																																																																																									
		065 ¹⁾ [2.56]	083 ¹⁾ [3.27]							0352 02	MP 35.2 open Crossbar on outside bend Crossbar on inside bend Opens on inside of bend	075 [2.95]	093 [3.66]			075 [2.95]	1 Plastic, full-ridged without bias	3 Polyamide with attenuator (PA/black)		090 ¹⁾ [3.54]	108 ¹⁾ [4.25]					100 [3.94]	118 [4.65]			100 [3.94]		9 Special version (on request)				125 [4.92]	143 [5.63]					150 [5.91]	168 [6.61]			125 [4.92]						175 [6.89]	193 [7.60]									150 [5.91]																175 [6.89]																200 [7.87]																250 [9.84]			
0352 02	MP 35.2 open Crossbar on outside bend Crossbar on inside bend Opens on inside of bend	075 [2.95]	093 [3.66]			075 [2.95]	1 Plastic, full-ridged without bias	3 Polyamide with attenuator (PA/black)																																																																																																									
		090 ¹⁾ [3.54]	108 ¹⁾ [4.25]									100 [3.94]	118 [4.65]			100 [3.94]		9 Special version (on request)				125 [4.92]	143 [5.63]					150 [5.91]	168 [6.61]			125 [4.92]						175 [6.89]	193 [7.60]									150 [5.91]																175 [6.89]																200 [7.87]																250 [9.84]																	
		100 [3.94]	118 [4.65]			100 [3.94]		9 Special version (on request)																																																																																																									
		125 [4.92]	143 [5.63]									150 [5.91]	168 [6.61]			125 [4.92]						175 [6.89]	193 [7.60]									150 [5.91]																175 [6.89]																200 [7.87]																250 [9.84]																																	
		150 [5.91]	168 [6.61]			125 [4.92]																																																																																																											
		175 [6.89]	193 [7.60]													150 [5.91]																175 [6.89]																200 [7.87]																250 [9.84]																																																	
						150 [5.91]																																																																																																											
																175 [6.89]																200 [7.87]																250 [9.84]																																																																	
						175 [6.89]																																																																																																											
																200 [7.87]																250 [9.84]																																																																																	
						200 [7.87]																																																																																																											
																250 [9.84]																																																																																																	
						250 [9.84]																																																																																																											

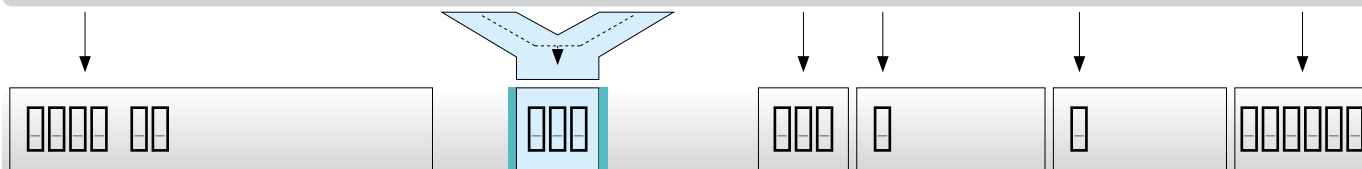

ORDERING EXAMPLE: 0352 02 075 100 0 3 2000

Crossbar on outside bend, crossbar on inside bend, can be opened from inside bend
 Inside width 2.95 in. (075 mm), radius 3.94 in. (100 mm)
 Plastic, full-ridged with bias, material polyamide with damper (PA/black)
 Chain length 2000 mm (36 links)

¹⁾ available from Q 4/2018

SELF-SUPPORTING LENGTH

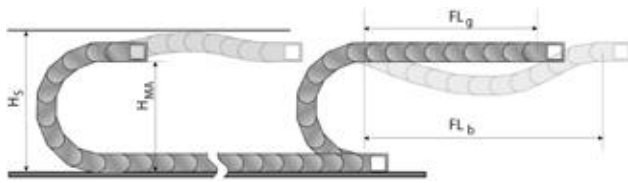

The self-supporting length is the distance between the chain bracket on the moving end and the start of the chain arch.
 The installation variant FL_g offers the lowest load and wear for the cable drag chain.
 The maximum travel parameters (speed and acceleration) can be applied for this variant.

- H_s = Installation height plus safety
- H_{MA} = Height of moving end connection
- FL_g = Self-supporting length, upper run straight
- FL_b = Self-supporting length, upper run bent

LOAD DIAGRAM FOR SELF-SUPPORTING APPLICATIONS

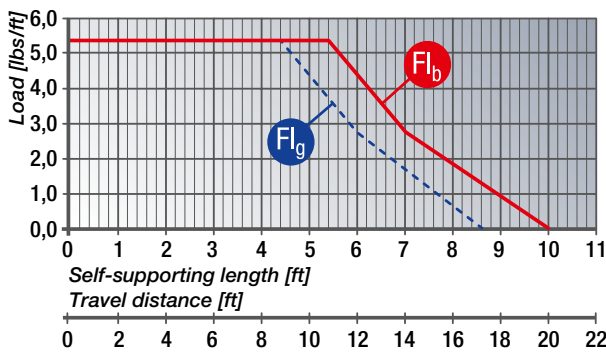

FL_g Self-supporting length, upper run straight

In the FL_g range, the chain upper run still has a bias, is straight or has a maximum sag of 2.36 inch.

FL_b Self-supporting length, upper run bent

In the FL_b range, the chain upper run has a sag of more than 2.36 inch, but this is still less than the maximum sag. Where the sag is greater than that permitted in the FL_b range, the application is critical and should be avoided. The self-supporting length can be optimized by using a support for the upper run or a more stable cable drag chain.

DETERMINING THE CHAIN LENGTH

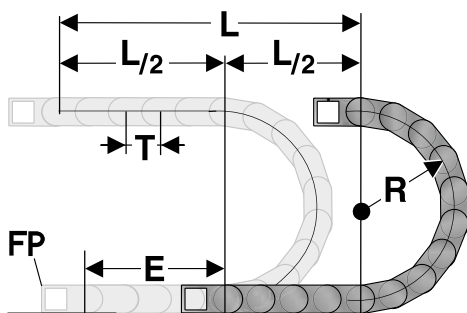

The fixed point of the cable drag chain should be connected in the middle of the travel distance.
 This arrangement gives the shortest connection between the fixed point (FP) and the moving bracket and thus the most efficient chain length.

Chain length calculation = $L/2 + \pi * R + E$
 $\approx 1 \text{ ft chain} = 6 \text{ qty.} \times 2.20 \text{ inch.}$

- E = Distance between entry point and middle of travel distance
- L = Travel distance
- R = Radius
- P = Grid 2.20 inch

INSTALLATION DIMENSIONS

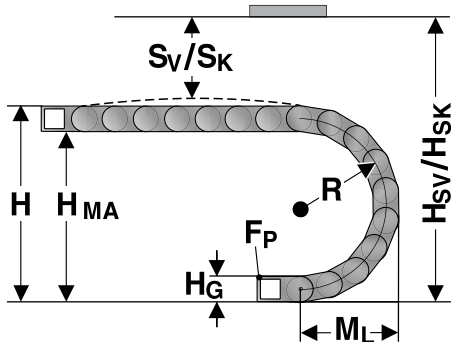

The moving end chain connection is to be screw fixed at height H_{MA} for the respective radius.

Concerning the installed dimensions, you must take into account whether the chain links are equipped with or without bias. For chain links without bias, the “Installed height without bias H_{SK} ” value has to be taken into account.

If the chain links are equipped with a bias, the value “Installed height with bias H_{SV} ” has to be taken into account.

Radius R	63	75	100	125	150	175	200	250
Outside height of chain link (H_G)	1.93	1.93	1.93	1.93	1.93	1.93	1.93	1.93
Height of bend (H)	127.93	151.93	201.93	251.93	301.93	351.93	401.93	501.93
Height of moving end connection (H_{MA})	126.00	150.00	200.00	250.00	300.00	350.00	400.00	500.00
Safety margin with bias (S_V)	0.79	0.79	0.79	0.79	0.79	0.79	0.79	0.79
Installation height with bias (H_{SV}) without damper	130.69	154.69	204.69	254.69	304.69	354.69	404.69	504.69
Installation height with bias (H_{SV}) with damper	131.48	155.48	205.48	255.48	305.48	355.48	405.48	505.48
Safety margin without bias (S_K)	0.79	0.79	0.79	0.79	0.79	0.79	0.79	0.79
Installation height without bias (H_{SK}) without damper	128.72	152.72	202.72	252.72	302.72	352.72	402.72	502.72
Installation height without bias (H_{SK}) with damper	129.51	153.51	203.51	253.51	303.51	353.51	403.51	503.51
Arc projection (M_L)	66.17	78.17	103.17	128.17	153.17	178.17	203.17	253.17

DAMPING ELEMENT FOR THE CHAIN LINKS

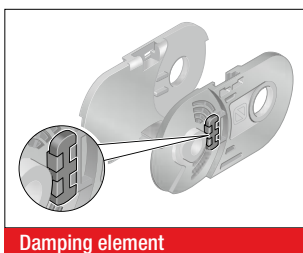

Damping element

The dampening elements in the stops make for a significantly quieter unrolling of the chain links. The dampers can be chosen optionally.

A reduction of the noise emission by up to 10 dB(A) comparing to the variants without the use of damping elements is possible.

CHAIN BRACKET KA 35

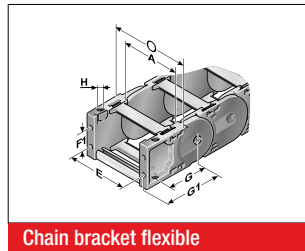
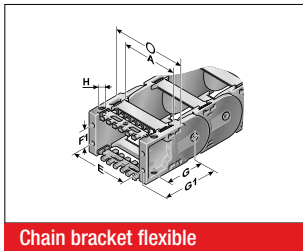

This chain bracket offers universal connection options (top, bottom and front) and is attached to the ends of the cable drag chain like a side link. This allows the chain to move right up to the bracket. Each cable drag chain requires one male and one female bracket. M5 screws are used to secure the brackets in place. Press-in metal bushes with a through-hole ensure the permanent, high-strength transmission of even extreme forces onto the cable drag chain.

By default, the chain bracket is supplied with crossbars.

The chain bracket can then be optionally fitted with crossbar strain relief plates (RS-ZL) or with strain relief using C-rails and type STF bow clamps.

Type	Order No.	Material	Inside width								Outside width of KA O inch
			A inch	E inch	F1 inch	G inch	G1 inch	H inch	H0 inch		
KA 35-FB Female end, 050, complete	0350005050	Plastic	1.97	A+0.31	0.75	1.93	3.06	M5	0.22	A+0.75	
KA 35-FB Female end, 050, pendular, complete	0350005052	Plastic	1.97	A+0.31	0.75	1.93	3.06	M5	0.22	A+0.75	
KA 35-FB Male end, 050, complete	0350005051	Plastic	1.97	A+0.31	0.75	1.93	3.06	M5	0.22	A+0.75	
KA 35-FB Male end, 050, pendular, complete	0350005053	Plastic	1.97	A+0.31	0.75	1.93	3.06	M5	0.22	A+0.75	
KA 35-FB Female end, 065, complete	0350006550	Plastic	2.56	A+0.31	0.75	1.93	3.06	M5	0.22	A+0.75	
KA 35-FB Female end, 065, pendular, complete	0350006552	Plastic	2.56	A+0.31	0.75	1.93	3.06	M5	0.22	A+0.75	
KA 35-FB Male end, 065, complete	0350006551	Plastic	2.56	A+0.31	0.75	1.93	3.06	M5	0.22	A+0.75	
KA 35-FB Male end, 065, pendular, complete	0350006553	Plastic	2.56	A+0.31	0.75	1.93	3.06	M5	0.22	A+0.75	
KA 35-FB Female end, 075, complete	0350007550	Plastic	2.95	A+0.31	0.75	1.93	3.06	M5	0.22	A+0.75	
KA 35-FB Female end, 075, pendular, complete	0350007552	Plastic	2.95	A+0.31	0.75	1.93	3.06	M5	0.22	A+0.75	
KA 35-FB Male end, 075, complete	0350007551	Plastic	2.95	A+0.31	0.75	1.93	3.06	M5	0.22	A+0.75	
KA 35-FB Male end, 075, pendular, complete	0350007553	Plastic	2.95	A+0.31	0.75	1.93	3.06	M5	0.22	A+0.75	
KA 35-FB Female end, 090, complete	0350009050	Plastic	3.54	A+0.31	0.75	1.93	3.06	M5	0.22	A+0.75	
KA 35-FB Female end, 090, pendular, complete	0350009052	Plastic	3.54	A+0.31	0.75	1.93	3.06	M5	0.22	A+0.75	
KA 35-FB Male end, 090, complete	0350009051	Plastic	3.54	A+0.31	0.75	1.93	3.06	M5	0.22	A+0.75	
KA 35-FB Male end, 090, pendular, complete	0350009053	Plastic	3.54	A+0.31	0.75	1.93	3.06	M5	0.22	A+0.75	
KA 35-FB Female end, 100, complete	0350010050	Plastic	3.94	A+0.31	0.75	1.93	3.06	M5	0.22	A+0.75	
KA 35-FB Female end, 100, pendular, complete	0350010052	Plastic	3.94	A+0.31	0.75	1.93	3.06	M5	0.22	A+0.75	
KA 35-FB Male end, 100, complete	0350010051	Plastic	3.94	A+0.31	0.75	1.93	3.06	M5	0.22	A+0.75	
KA 35-FB Male end, 100, pendular, complete	0350010053	Plastic	3.94	A+0.31	0.75	1.93	3.06	M5	0.22	A+0.75	
KA 35-FB Female end, 125, complete	0350012550	Plastic	4.92	A+0.31	0.75	1.93	3.06	M5	0.22	A+0.75	
KA 35-FB Female end, 125, pendular, complete	0350012552	Plastic	4.92	A+0.31	0.75	1.93	3.06	M5	0.22	A+0.75	
KA 35-FB Male end, 125, complete	0350012551	Plastic	4.92	A+0.31	0.75	1.93	3.06	M5	0.22	A+0.75	
KA 35-FB Male end, 125, pendular, complete	0350012553	Plastic	4.92	A+0.31	0.75	1.93	3.06	M5	0.22	A+0.75	
KA 35-FB Female end, 150, complete	0350015050	Plastic	5.91	A+0.31	0.75	1.93	3.06	M5	0.22	A+0.75	
KA 35-FB Female end, 150, pendular, complete	0350015052	Plastic	5.91	A+0.31	0.75	1.93	3.06	M5	0.22	A+0.75	
KA 35-FB Male end, 150, complete	0350015051	Plastic	5.91	A+0.31	0.75	1.93	3.06	M5	0.22	A+0.75	
KA 35-FB Male end, 150, pendular, complete	0350015053	Plastic	5.91	A+0.31	0.75	1.93	3.06	M5	0.22	A+0.75	
KA 35-FB Female end, 175, complete	0350017550	Plastic	6.89	A+0.31	0.75	1.93	3.06	M5	0.22	A+0.75	
KA 35-FB Female end, 175, pendular, complete	0350017552	Plastic	6.89	A+0.31	0.75	1.93	3.06	M5	0.22	A+0.75	
KA 35-FB Male end, 175, complete	0350017551	Plastic	6.89	A+0.31	0.75	1.93	3.06	M5	0.22	A+0.75	
KA 35-FB Male end, 175, pendular, complete	0350017553	Plastic	6.89	A+0.31	0.75	1.93	3.06	M5	0.22	A+0.75	

TRT 35 DIVISIBLE SEPARATOR

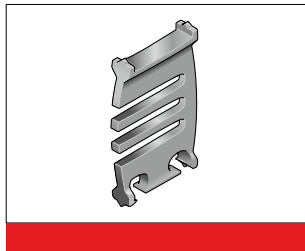
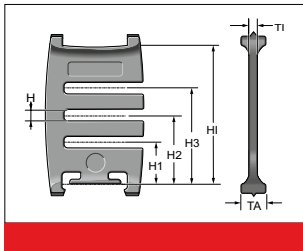

We recommend that separators be used if multiple round cables or conduits with differing diameters are to be installed.

Type	Order No.	Description	Version	TI inch	TA inch	H inch	H1 inch	H2 inch	H3 inch	H4 inch
TRT 35	035000009400	TRT 35, separator, divisible	lockable	0.12	0.31	0.13	0.41	0.69	0.96	1.38

TR 35-V SEPARATOR

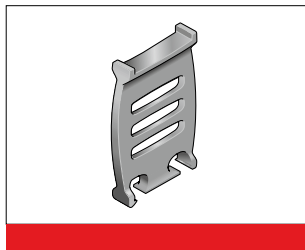
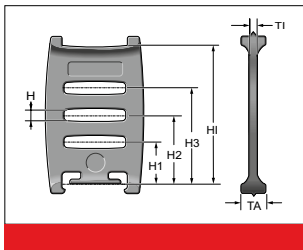

We recommend that separators be used if multiple round cables or conduits with differing diameters are to be installed.

Type	Order No.	Description	Version	TI inch	TA inch	H inch	H1 inch	H2 inch	H3 inch	H4 inch
TR 35-V	035000009300	TR 35-V Separator	movable	0.12	0.31	0.13	0.41	0.69	0.96	1.38

RTT 35 SHELF SUPPORT, DIVISIBLE

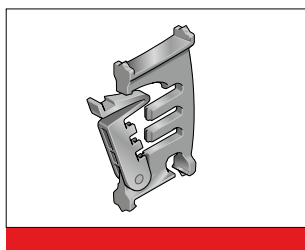
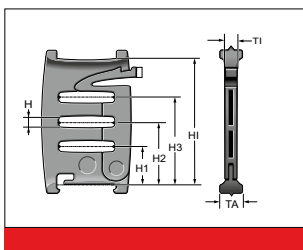

In connection with two separable shelf supports (RTT) with at least one end-to-end shelf (RB) the shelf becomes an easy to fill shelving system. The additional levels prevent cables from criss-crossing and minimize the friction between them.

Type	Order No.	Description	Version	TI inch	TA inch	H inch	H1 inch	H2 inch	H3 inch	H4 inch
RTT 35	100090350000	Shelf support, divisible	lockable	0.20	0.31	0.13	0.41	0.69	0.96	1.38

RB-3 SHELF

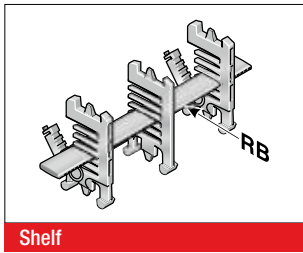

In connection with at least two separable shelf supports (RTT), the shelf becomes a shelving system. The additional levels prevent cables from criss-crossing and minimize the friction between them.

Type	Order No.	Description	Width inch	Inside width inch
RB 039-3	030100003900	Shelf	1.52	1.57
RB 041-3	1000004103	Shelf	1.62	1.97
RB 044-3	1000004403	Shelf	1.72	1.97
RB 046-3	1000004603	Shelf	1.81	1.97
RB 049-3	030100004900	Shelf	1.91	1.97
RB 051-3	1000005103	Shelf	2.01	2.36
RB 054-3	1000005403	Shelf	2.11	2.36
RB 056-3	1000005603	Shelf	2.21	2.36
RB 059-3	030100005900	Shelf	2.31	2.36
RB 061-3	1000006103	Shelf	2.41	2.95
RB 064-3	1000006403	Shelf	2.50	2.95
RB 066-3	1000006603	Shelf	2.60	2.95
RB 069-3	1000006903	Shelf	2.70	2.95
RB 071-3	1000007103	Shelf	2.80	2.95
RB 074-3	030100007400	Shelf	2.90	2.95
RB 076-3	1000007603	Shelf	3.00	3.35
RB 079-3	1000007903	Shelf	3.09	3.35
RB 081-3	1000008103	Shelf	3.19	3.35
RB 084-3	030100008400	Shelf	3.29	3.35
RB 086-3	1000008603	Shelf	3.39	3.94
RB 089-3	1000008903	Shelf	3.49	3.94
RB 091-3	1000009103	Shelf	3.59	3.94
RB 094-3	1000009403	Shelf	3.69	3.94
RB 096-3	1000009603	Shelf	3.78	3.94
RB 099-3	030100009900	Shelf	3.88	3.94
RB 101-3	1000010103	Shelf	3.98	4.53
RB 104-3	1000010403	Shelf	4.08	4.53
RB 106-3	1000010603	Shelf	4.18	4.53
RB 109-3	1000010903	Shelf	4.28	4.53
RB 111-3	1000011103	Shelf	4.37	4.53
RB 114-3	030100011400	Shelf	4.47	4.53
RB 116-3	1000011603	Shelf	4.57	4.92
RB 119-3	1000011903	Shelf	4.67	4.92
RB 121-3	1000012103	Shelf	4.77	4.92
RB 124-3	030100012400	Shelf	4.87	4.92
RB 126-3	1000012603	Shelf	4.96	5.91

RB-3 SHELF

Type	Order No.	Description	Width inch	Inside width inch
RB 129-3	1000012903	Shelf	5.06	5.91
RB 131-3	1000013103	Shelf	5.16	5.91
RB 134-3	1000013403	Shelf	5.26	5.91
RB 136-3	1000013603	Shelf	5.36	5.91
RB 139-3	1000013903	Shelf	5.46	5.91
RB 141-3	1000014103	Shelf	5.56	5.91
RB 144-3	1000014403	Shelf	5.65	5.91
RB 146-3	1000014603	Shelf	5.75	5.91
RB 149-3	030100014900	Shelf	5.85	5.91
RB 151-3	1000015103	Shelf	5.95	6.89
RB 154-3	1000015403	Shelf	6.05	6.89
RB 156-3	1000015603	Shelf	6.15	6.89
RB 159-3	1000015903	Shelf	6.24	6.89
RB 161-3	1000016103	Shelf	6.34	6.89
RB 164-3	1000016403	Shelf	6.44	6.89
RB 166-3	1000016603	Shelf	6.54	6.89
RB 169-3	1000016903	Shelf	6.64	6.89
RB 174-3	030100017400	Shelf	6.83	6.89

RS-ZL-3 ZLA MP 35 CROSSBAR STRAIN RELIEF PLATE

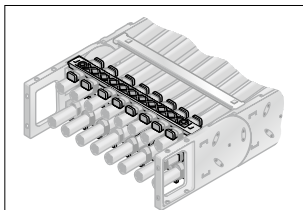

Crossbar strain relief plate

Fixed integrated crossbar strain relief plates in the chain brackets. Tailored to all crossbars widths up to 6.89 inch (175 mm). May be assembled on the inside and outside bends at both chain endings.

Type	Order No.	Description	Inside width inch
RS-ZL 050-3 ZLA MP 35	0351050010	Crossbar strain relief plate	1.97
RS-ZL 075-3 ZLA MP 35	0351075010	Crossbar strain relief plate	2.95
RS-ZL 100-3 ZLA MP 35	0351100010	Crossbar strain relief plate	3.94
RS-ZL 125-3 ZLA MP 35	0351125010	Crossbar strain relief plate	4.92
RS-ZL 150-3 ZLA MP 35	0351150010	Crossbar strain relief plate	5.91
RS-ZL 175-3 ZLA MP 35	0351175010	Crossbar strain relief plate	6.89

STRAIN RELIEF WITH STEEL FIX

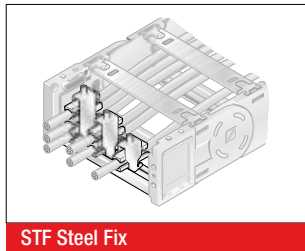
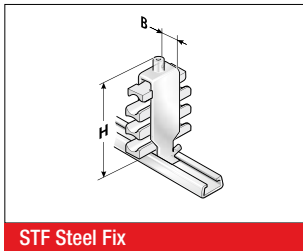

C-rails (galvanized) for permanent integration, for accommodating the Steel Fix bow clamps in the chain brackets. The bow clamps can take up to 3 cables and are suitable for C-rails with a groove width of 0.43 in (11 mm). Due to the design of the trough elements, a cable preserving cable guidance is ensured. May be assembled on the inside and outside bends at both chain endings. The overall height stated is a guide only. The actual height is, amongst other things, dependent on the diameter and the quality of the cable. A safety distance of 0.39 in (10 mm) at the fixed point above the strain relief must be kept during gliding applications.

Type	Order No.	Description	Seats qty.	Cable Ø inch	Width (B) inch	Total height (H) inch
Single clamp (for one cable)						
STF 12-1 Steel Fix	81661801	Hooped clamp	1	0.24 – 0.47	0.63	2.17
STF 14-1 Steel Fix	81661802	Hooped clamp	1	0.47 – 0.55	0.71	2.05
STF 16-1 Steel Fix	81661803	Hooped clamp	1	0.55 – 0.63	0.79	2.13
STF 18-1 Steel Fix	81661804	Hooped clamp	1	0.63 – 0.71	0.87	2.20
STF 20-1 Steel Fix	81661805	Hooped clamp	1	0.71 – 0.79	0.94	2.32
STF 22-1 Steel Fix	81661806	Hooped clamp	1	0.79 – 0.87	1.02	2.40
STF 26-1 Steel Fix	81661807	Hooped clamp	1	0.87 – 1.02	1.18	2.76
STF 30-1 Steel Fix	81661808	Hooped clamp	1	1.02 – 1.18	1.34	2.91
STF 34-1 Steel Fix	81661809	Hooped clamp	1	1.18 – 1.34	1.50	3.07
STF 38-1 Steel Fix	81661810	Hooped clamp	1	1.34 – 1.50	1.65	3.23
STF 42-1 Steel Fix	81661811	Hooped clamp	1	1.50 – 1.65	1.81	3.58
Double clamp (for two cables)						
STF 12-2 Steel Fix	81661821	Hooped clamp	2	0.24 – 0.47	0.63	2.87
STF 14-2 Steel Fix	81661822	Hooped clamp	2	0.47 – 0.55	0.71	2.91
STF 16-2 Steel Fix	81661823	Hooped clamp	2	0.55 – 0.63	0.79	3.23
STF 18-2 Steel Fix	81661824	Hooped clamp	2	0.63 – 0.71	0.87	3.39
STF 20-2 Steel Fix	81661825	Hooped clamp	2	0.71 – 0.79	0.94	3.58
STF 22-2 Steel Fix	81661826	Hooped clamp	2	0.79 – 0.87	1.02	3.74
STF 26-2 Steel Fix	81661827	Hooped clamp	2	0.87 – 1.02	1.18	4.25
STF 30-2 Steel Fix	81661828	Hooped clamp	2	1.02 – 1.18	1.34	4.76
STF 34-2 Steel Fix	81661829	Hooped clamp	2	1.18 – 1.34	1.50	5.08
Triple clamp (for three cables)						
STF 12-3 Steel Fix	81661841	Hooped clamp	3	0.24 – 0.47	0.63	3.86
STF 14-3 Steel Fix	81661842	Hooped clamp	3	0.47 – 0.55	0.71	3.86
STF 16-3 Steel Fix	81661843	Hooped clamp	3	0.55 – 0.63	0.79	4.13
STF 18-3 Steel Fix	81661844	Hooped clamp	3	0.63 – 0.71	0.87	4.37
STF 20-3 Steel Fix	81661845	Hooped clamp	3	0.71 – 0.79	0.94	4.65
STF 22-3 Steel Fix	81661846	Hooped clamp	3	0.79 – 0.87	1.02	5.12

LOWERED FIXING POINT MP 35

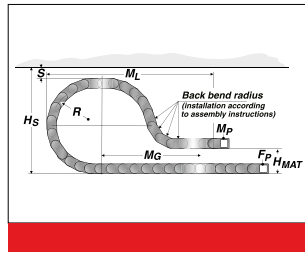
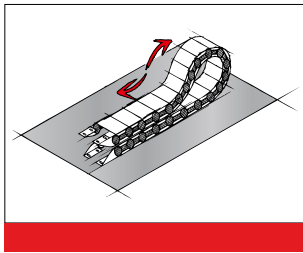

It is sometimes necessary to lower the height of the moving attachment point.
 In such cases, modifications to the chain layout should be noted (e.g. extension of chain).
 Please contact our application engineers.

Radius R inch	Height of moving end connection (H _{MA}) inch	Safety margin (S) inch	Installation height incl. safety (h _S) inch	Projection (M _L) inch	Additional links qty.	of which additional back chain links qty.
5.91	7.09	1.97	15.71	23.23	12	4
6.89	7.09	1.97	17.68	26.77	15	4
7.87	7.09	1.97	19.65	30.71	18	5
9.84	7.09	1.97	23.58	38.58	24	5

GUIDE CHANNEL VAW (ALUMINUM / STAINLESS STEEL)



VAW steel galvanized / stainless steel

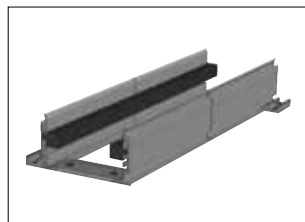

VAW aluminum

A range of variable guide channel systems, constructed from aluminum or stainless steel sections, is available for this cable drag chain.
 The variable guide channel ensures that the cable drag chain is supported and guided securely.

ASSEMBLY

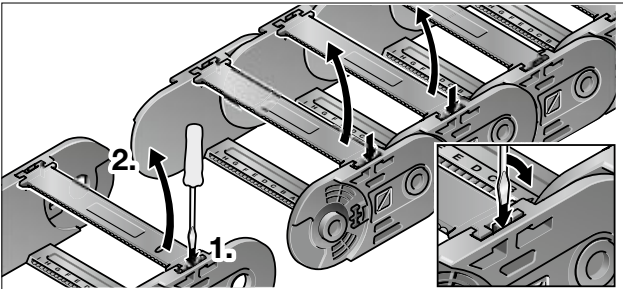

Step 1

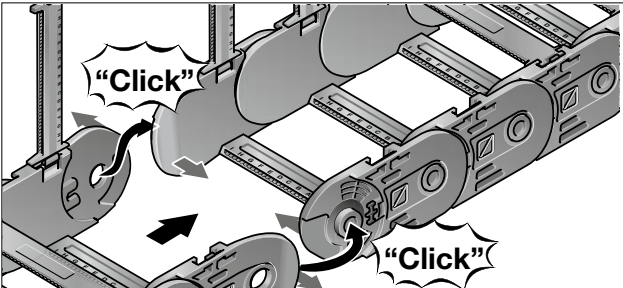

Step 2

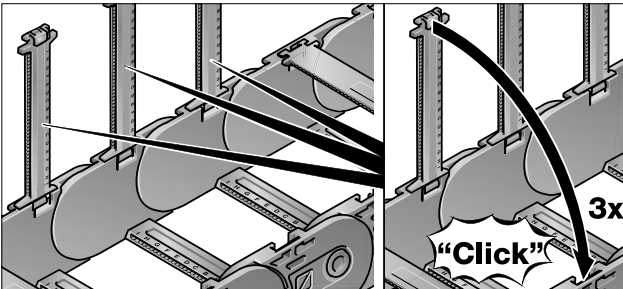

Step 3

DISASSEMBLY

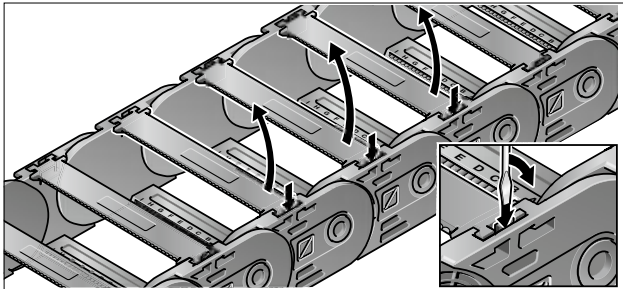

Step 1

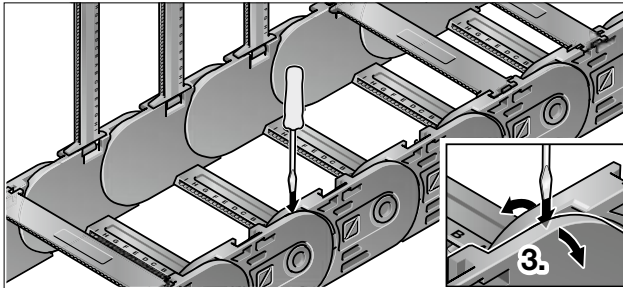

Step 2

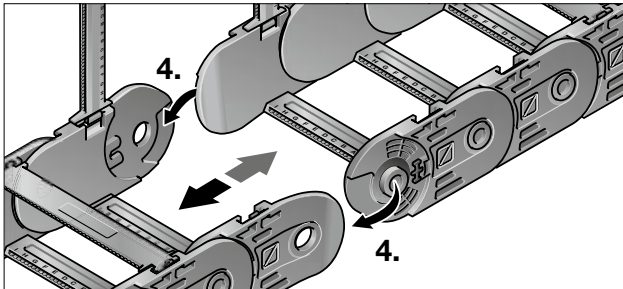

Step 3

MP 36G

CLOSED



- CLOSED VARIANTS, STARTING WITH R80
- METAL CHAIN BRACKET

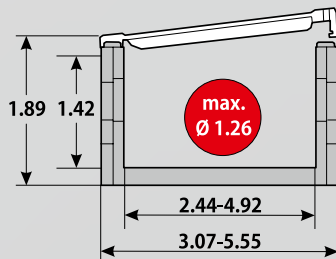

TECHNICAL DATA

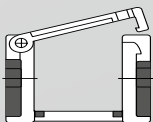

Loading side
Inside bend

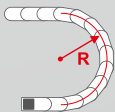

Available radii
3.15 – 7.87 inch

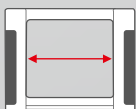

Available interior widths
With plastic crossbar
2.44 – 4.92 inch

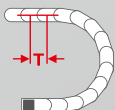

Grid
T = 1.57 inch

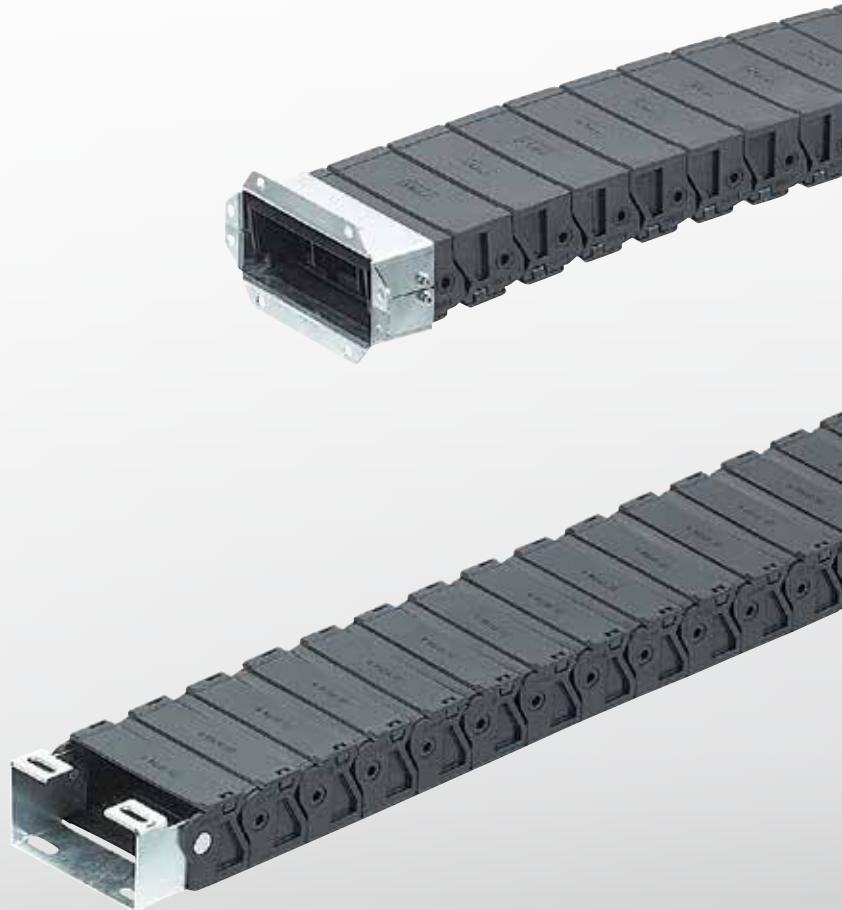

TECHNICAL SPECIFICATIONS

Travel distance gliding L_g max.	196.85 ft.
Travel distance self-supporting L_s max.	see diagram on page 129
Travel distance vertical, hanging L_{vh} max.	98.43 ft.
Travel distance vertical, upright L_{vs} max.	9.84 ft.
Rotated 90°, unsupported L_{90f} max.	3.28 ft.
Speed, gliding V_g max.	9.84 ft/s
Speed, self-supporting V_f max.	32.81 ft/s
Acceleration, gliding a_g max.	49.21 ft/s ²
Acceleration, self-supporting a_s max.	65.62 ft/s ²

Contact our engineering department to meet any higher requirements: efk@murrplastik.de

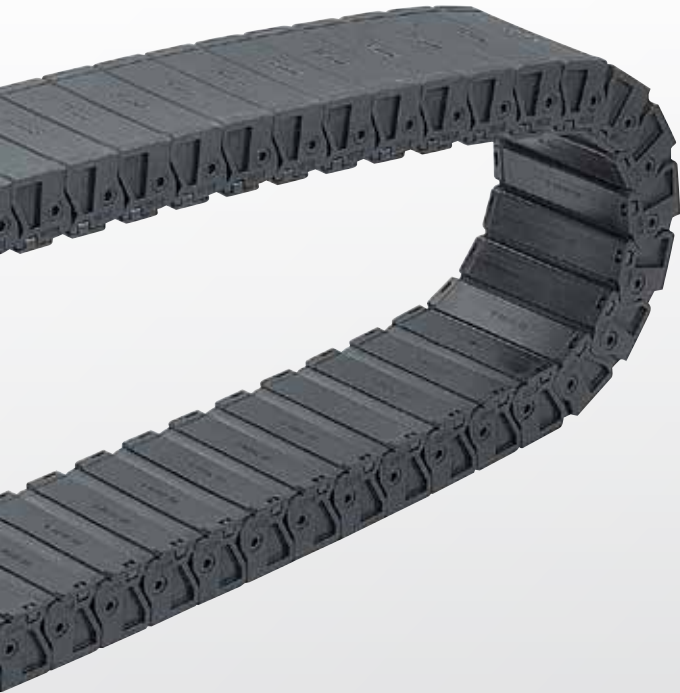

MATERIAL PROPERTIES

Standard material	Polyamide (PA) black
Service temperature	-22.00 – 248.00 °F
Gliding friction factor	0.30
Static friction factor	0.45
Fire classification	Based on UL 94 HB

Other material properties on request

CHAIN BRACKET

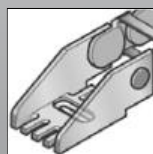

Chain bracket U-part

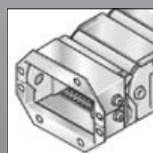

Chain bracket flange

SHELVING SYSTEM

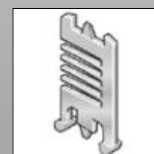

Separator TR



RS shelving system

GUIDE CHANNELS



VAW steel galvanized / stainless steel



VAW aluminum

ORDERING KEY

Dimensions in mm [US inch]

Type code	Variation	Inside width	Outside width	Inside width	Outside width	Radius	Rail variant	Material	Chain length
0360 04	Cover on outside of bend Cover on inside of bend Opens on inside of bend	062 [2.44]	078 [3.07]			080 [3.15]	0 Plastic, full-ridged with bias	0 Polyamide (PA): standard (PA/black)	
		086 [3.39]	102 [4.02]						
		102 [4.02]	118 [4.65]			100 [3.94]		9 Special version (on request)	
		125 [4.92]	141 [5.55]			125 [4.92]			
						150 [5.91]			
						200 [7.87]			

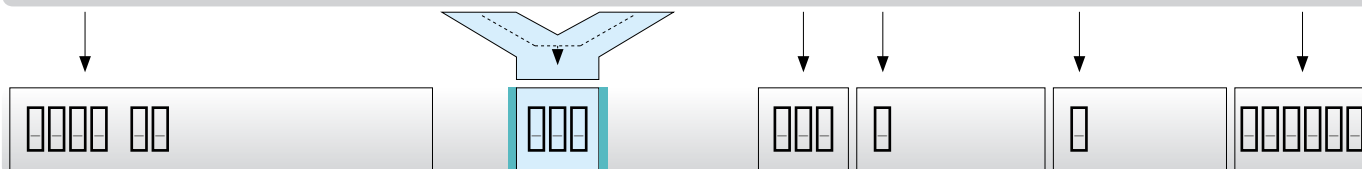

ORDERING EXAMPLE: 0360 062 080 0 0 000050

Cover in outside bend, cover in inside bend, openable from inside bend
 Inside width 2.44 in.; radius 3.15 in.
 Plastic crossbar, full-ridged with bias, material black-colored polyamide
 Chain length 50 in. (32 links)

SELF-SUPPORTING LENGTH

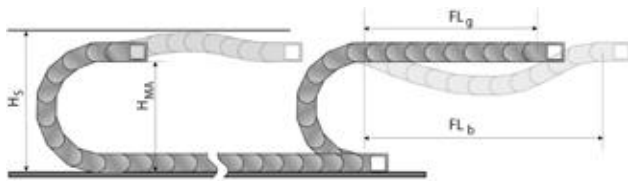

The self-supporting length is the distance between the chain bracket on the moving end and the start of the chain arch.
 The installation variant FL_g offers the lowest load and wear for the cable drag chain.
 The maximum travel parameters (speed and acceleration) can be applied for this variant.

- H_s = Installation height plus safety
- H_{MA} = Height of moving end connection
- FL_g = Self-supporting length, upper run straight
- FL_b = Self-supporting length, upper run bent

LOAD DIAGRAM FOR SELF-SUPPORTING APPLICATIONS

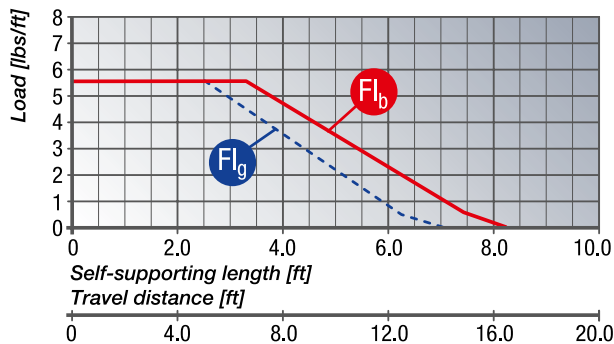

FL_g Self-supporting length, upper run straight
 In the FL_g range, the chain upper run still has a bias, is straight or has a maximum sag of 2.36 inch.

FL_b Self-supporting length, upper run bent
 In the FL_b range, the chain upper run has a sag of more than 2.36 inch, but this is still less than the maximum sag. Where the sag is greater than that permitted in the FL_b range, the application is critical and should be avoided. The self-supporting length can be optimized by using a support for the upper run or a more stable cable drag chain.

DETERMINING THE CHAIN LENGTH

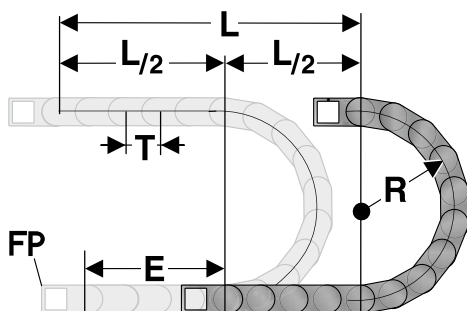

The fixed point of the cable drag chain should be connected in the middle of the travel distance.
 This arrangement gives the shortest connection between the fixed point and the moving bracket and thus the most efficient chain length.

Chain length calculation = $L/2 + \pi * R + 2 * T + E$
 $\approx 1 \text{ ft chain} = 8 \text{ qty.} \times 1.57 \text{ inch.}$

- E = Distance between entry point and middle of travel distance
- L = Travel distance
- R = Radius
- P = Grid 1.57 inch

INSTALLATION DIMENSIONS

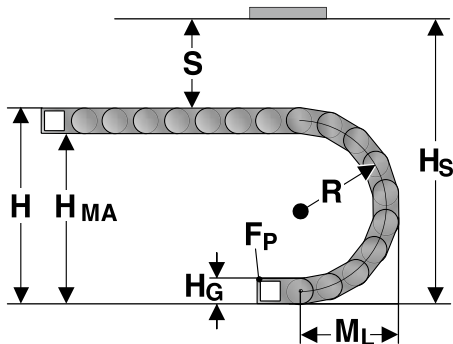

The moving end chain connection is to be screw fixed at height H_{MA} for the respective radius.
For the installed dimension the “Installed height H_s ” value has to be taken into account.

Radius R	3.15	3.94	4.92	5.91	7.87
Outside height of chain link (H_G)	1.89	1.89	1.89	1.89	1.89
Height of bend (H)	8.19	9.77	11.73	13.71	17.63
Height of moving end connection (H_{MA})	6.30	7.88	9.84	11.82	15.74
Safety margin (S)	1.26	1.26	1.26	1.26	1.26
Installation height (H_s)	9.45	11.03	12.99	14.97	18.89
Arc projection (M_L)	5.67	6.46	7.44	8.43	10.39

KA 36 G CHAIN BRACKET U-PART

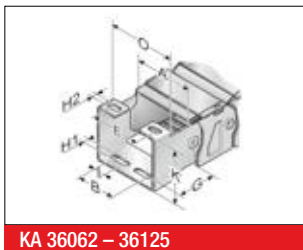

The chain bracket can be supplied either in galvanized sheet steel or stainless steel. To secure one cable drag chain, you will need a bracket with a drilled hole and a bracket with a bolt.

KA 36062 – 36125

Type	Order No.	Material	Inside width							Outside width of KA 0 inch
			A inch	E inch	G inch	H1 inch	H2 inch	I inch	K inch	
KA 36062 C Female end	036000001000	Sheet steel	2.44	A-0.30	1.65	0.26	0.26	0.24	1.92	A+0.47
KA 36062 C Male end	036000001100	Sheet steel	2.44	A-0.30	1.65	0.26	0.26	0.24	1.92	A+0.31
KA 36086 C Female end	036000001200	Sheet steel	3.39	A-0.30	1.65	0.26	0.26	0.61	1.92	A+0.47
KA 36086 C Male end	036000001300	Sheet steel	3.39	A-0.30	1.65	0.26	0.26	0.61	1.92	A+0.31
KA 36102 C Female end	036000001400	Sheet steel	4.02	A-0.30	1.65	0.26	0.26	0.61	1.92	A+0.47
KA 36102 C Male end	036000001500	Sheet steel	4.02	A-0.30	1.65	0.26	0.26	0.61	1.92	A+0.31
KA 36125 C Female end	036000001600	Sheet steel	4.92	A-0.30	1.65	0.26	0.26	0.61	1.92	A+0.47
KA 36125 C Male end	036000001700	Sheet steel	4.92	A-0.30	1.65	0.26	0.26	0.61	1.92	A+0.31
KA 36062 C Female end	036000002000	Stainless steel 1.4301	2.44	A-0.30	1.65	0.26	0.26	0.24	1.92	A+0.47
KA 36062 C Male end	036000002100	Stainless steel 1.4301	2.44	A-0.30	1.65	0.26	0.26	0.24	1.92	A+0.31
KA 36086 C Female end	036000002200	Stainless steel 1.4301	3.39	A-0.30	1.65	0.26	0.26	0.61	1.92	A+0.47
KA 36086 C Male end	036000002300	Stainless steel 1.4301	3.39	A-0.30	1.65	0.26	0.26	0.61	1.92	A+0.31
KA 36102 C Female end	036000002400	Stainless steel 1.4301	4.02	A-0.30	1.65	0.26	0.26	0.61	1.92	A+0.47
KA 36102 C Male end	036000002500	Stainless steel 1.4301	4.02	A-0.30	1.65	0.26	0.26	0.61	1.92	A+0.31
KA 36125 C Female end	036000002600	Stainless steel 1.4301	4.92	A-0.30	1.65	0.26	0.26	0.61	1.92	A+0.47
KA 36125 C Male end	036000002700	Stainless steel 1.4301	4.92	A-0.30	1.65	0.26	0.26	0.61	1.92	A+0.31

KA 36 CHAIN BRACKET FLANGE

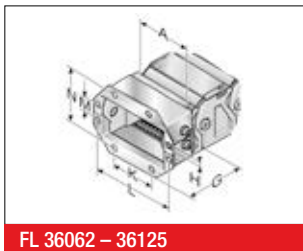

A cable drag chain requires two chain brackets. The divisible flange connection has been specifically designed for commissioning and re-installation. This keeps the chain in the installed position.

FL 36062 – 36125

Type	Order No.	Material	Inside width					
			A inch	H0 inch	K inch	L inch	M inch	N inch
FL 36062	0360062054	Sheet steel	2.44	0.28	1.57	3.85	0.71	2.70
FL 36086	0360086054	Sheet steel	3.39	0.28	2.52	4.80	0.71	2.70
FL 36102	0360102054	Sheet steel	4.02	0.28	3.15	5.43	0.71	2.70
FL 36125	0360125054	Sheet steel	4.92	0.28	4.06	6.33	0.71	2.70
FL 36062	0360062056	Stainless steel 1.4301	2.44	0.28	1.57	3.85	0.71	2.70
FL 36086	0360086056	Stainless steel 1.4301	3.39	0.28	2.52	4.80	0.71	2.70
FL 36102	0360102056	Stainless steel 1.4301	4.02	0.28	3.15	5.43	0.71	2.70
FL 36125	0360125056	Stainless steel 1.4301	4.92	0.28	4.06	6.33	0.71	2.70

TR 36G SEPARATOR

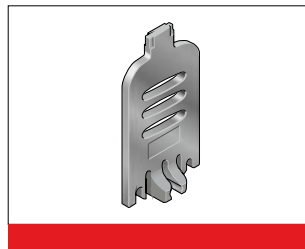
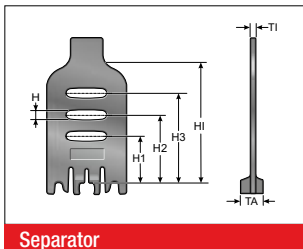

We recommend that separators be used if multiple round cables or conduits with differing diameters are to be installed.

Separator

Type	Order No.	Description	Version	TI inch	TA inch	H inch	H1 inch	H2 inch	H3 inch	HI inch
TR 36G	036000009200	Separator	lockable	0.10	0.41	0.10	0.53	0.77	1.00	1.44

MP 36G SHELVING SYSTEM

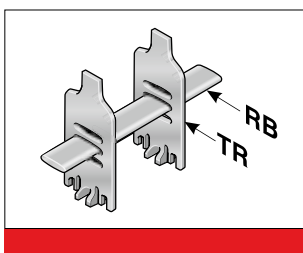

The shelf must be used with a minimum of two separators to create a shelving system. The additional levels prevent cables from criss-crossing and minimize the friction between them. The shelves are matched to the available chain widths.

Type	Order No.	Description	Width inch	Lock grid spacing inch
RBT 062	100000006200	Shelf	2.44	0.10
RBT 086	100000008600	Shelf	3.39	0.10
RBT 101	100000010100	Shelf	3.98	0.10
RBT 125	100000012500	Shelf	4.92	0.10

GUIDE CHANNEL VAW (ALUMINUM / STAINLESS STEEL)



A range of variable guide channel systems, constructed from aluminum or stainless steel sections, is available for this cable drag chain.

The variable guide channel ensures that the cable drag chain is supported and guided securely.

ASSEMBLY

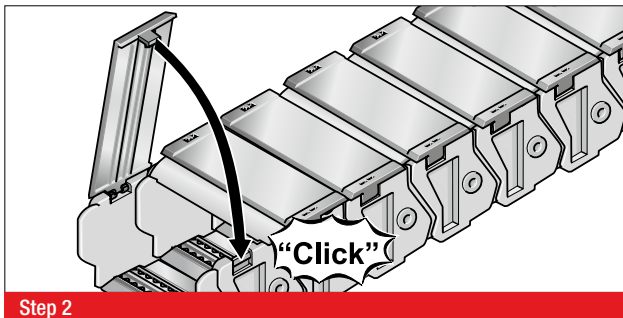
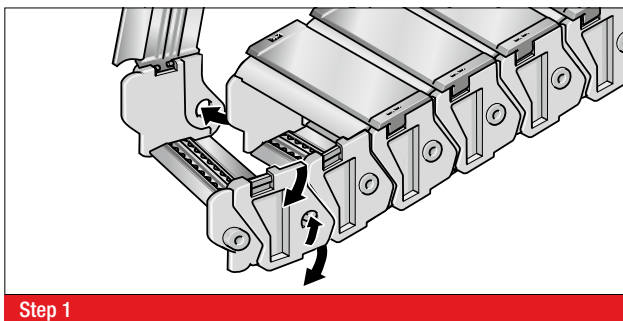

DISASSEMBLY

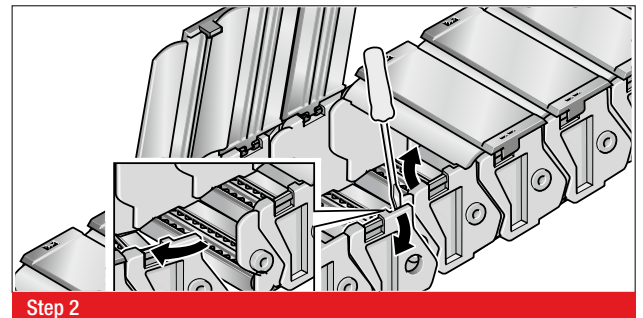
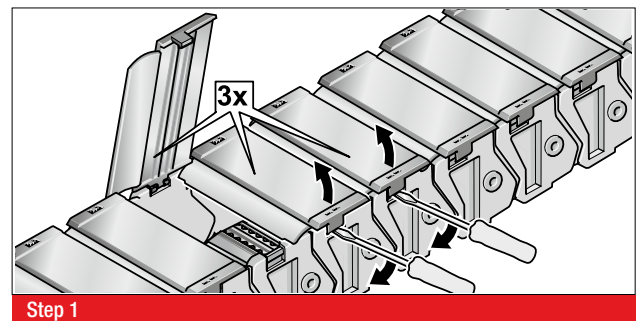

MP 43G

CLOSED



- METAL CHAIN BRACKET
- OPENS ON INSIDE AND OUTSIDE OF BEND

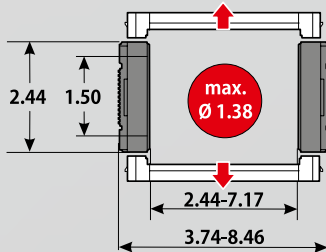

TECHNICAL DATA

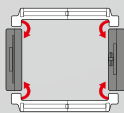

Loading side
Inside and outside bend

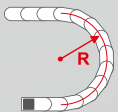

Available radii
4.92 – 15.75 inch

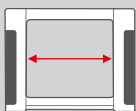

Available interior widths
With plastic crossbar
2.44 – 7.17 inch

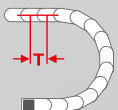

Grid
T = 2.97 inch

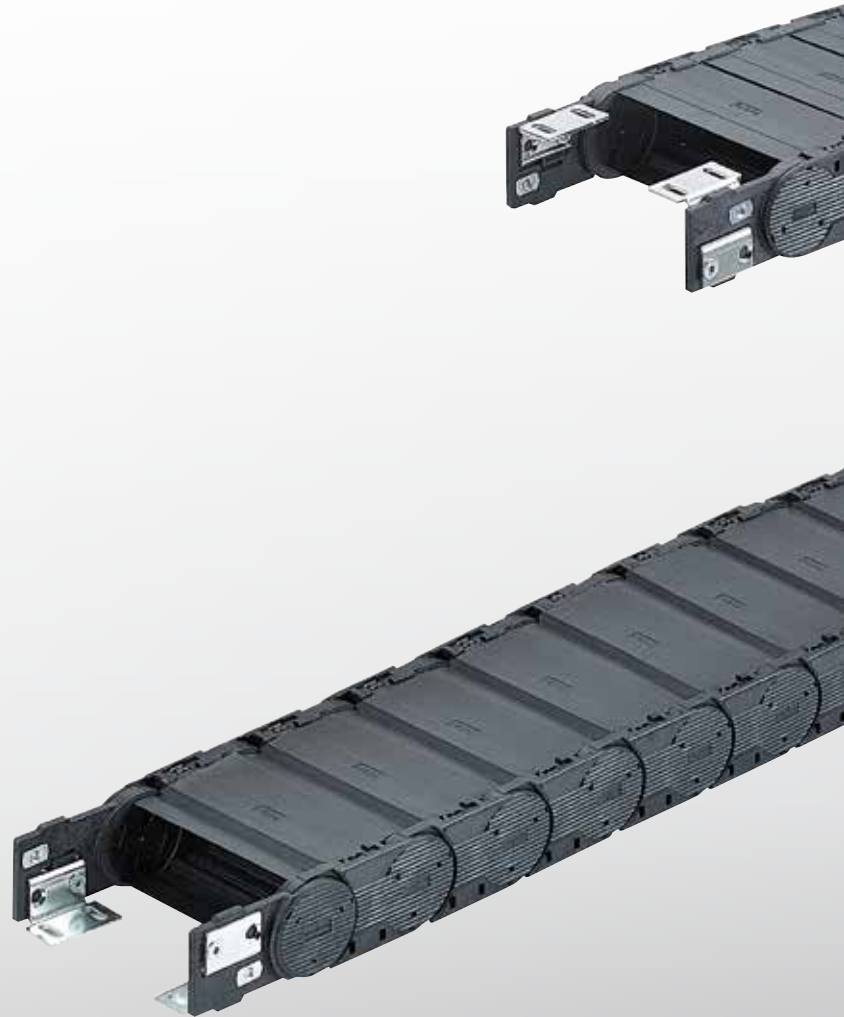



TECHNICAL SPECIFICATIONS

Travel distance gliding L_g max.	164.04 ft.
Travel distance self-supporting L_s max.	see diagram on page 137
Travel distance vertical, hanging L_{vh} max.	131.23 ft.
Travel distance vertical, upright L_{vs} max.	9.84 ft.
Rotated 90°, unsupported L_{90f} max.	3.28 ft.
Speed, gliding V_g max.	16.40 ft/s
Speed, self-supporting V_f max.	49.21 ft/s
Acceleration, gliding a_g max.	49.21 ft/s ²
Acceleration, self-supporting a_s max.	65.62 ft/s ²

Contact our engineering department to meet any higher requirements: efk@murrplastik.de

MATERIAL PROPERTIES

Standard material	Polyamide (PA) black
Service temperature	-22.00 – 248.00 °F
Gliding friction factor	0.30
Static friction factor	0.45
Fire classification	Based on UL 94 HB

Other material properties on request

SHELVING SYSTEM

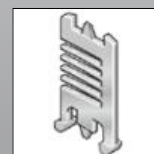

Separator TR

CHAIN BRACKET

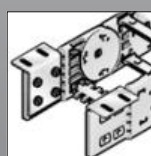

Chain bracket angle

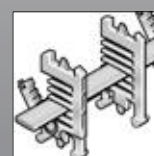

RS shelving system

GUIDE CHANNELS



VAW aluminum

ORDERING KEY

Dimensions in mm [US inch]

Type code	Variation	Inside width	Outside width	Inside width	Outside width	Radius	Rail variant	Material	Chain length																																																																										
0430 44	Cover on outside of bend Cover on inside of bend Opens on inside and outside of bend	062 [2.44]	095 [3.74]			125 [4.92]	0 Plastic, full-ridged with bias	0 Polyamide (PA): standard (PA/black)																																																																											
		084 [3.31]	117 [4.61]									105 [4.13]	138 [5.43]			150 [5.91]	1 Plastic, full-ridged without bias	9 Special version (on request)				144 [5.67]	177 [6.97]					182 [7.17]	215 [8.46]			200 [7.87]	9 Special version (on request)															250 [9.84]																300 [11.81]																400 [15.75]			
		105 [4.13]	138 [5.43]			150 [5.91]	1 Plastic, full-ridged without bias	9 Special version (on request)																																																																											
		144 [5.67]	177 [6.97]									182 [7.17]	215 [8.46]			200 [7.87]	9 Special version (on request)															250 [9.84]																300 [11.81]																400 [15.75]																			
		182 [7.17]	215 [8.46]			200 [7.87]	9 Special version (on request)																																																																												
																250 [9.84]																300 [11.81]																400 [15.75]																																			
						250 [9.84]																																																																													
																300 [11.81]																400 [15.75]																																																			
						300 [11.81]																																																																													
																400 [15.75]																																																																			
						400 [15.75]																																																																													

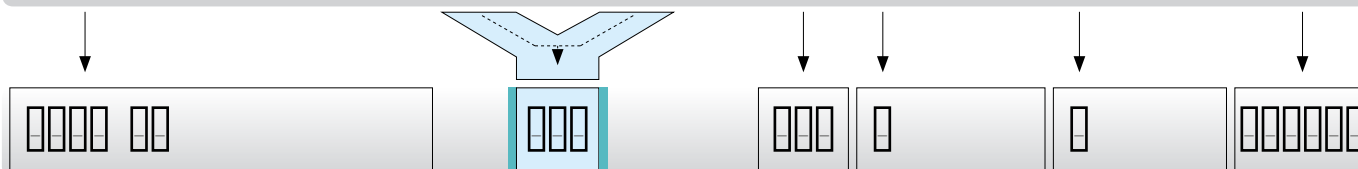

ORDERING EXAMPLE: 0430 062 125 0 0 000056

Cover in outside bend, cover in inside bend, openable from inside and outside bend
 Inside width 2.44 in.; radius 4.92 in.
 Plastic crossbar, full-ridged with bias, material black-colored polyamide
 Chain length 56 in. (19 links)

SELF-SUPPORTING LENGTH

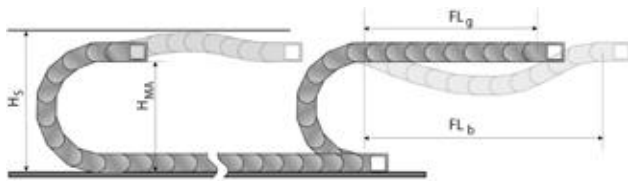

The self-supporting length is the distance between the chain bracket on the moving end and the start of the chain arch.
 The installation variant FL_g offers the lowest load and wear for the cable drag chain.
 The maximum travel parameters (speed and acceleration) can be applied for this variant.

- H_S = Installation height plus safety
- H_{MA} = Height of moving end connection
- FL_g = Self-supporting length, upper run straight
- FL_b = Self-supporting length, upper run bent

LOAD DIAGRAM FOR SELF-SUPPORTING APPLICATIONS

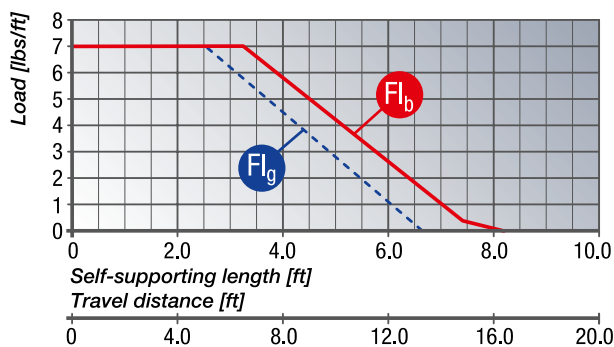

FL_g Self-supporting length, upper run straight
 In the FL_g range, the chain upper run still has a bias, is straight or has a maximum sag of 2.36 inch.

FL_b Self-supporting length, upper run bent
 In the FL_b range, the chain upper run has a sag of more than 2.36 inch, but this is still less than the maximum sag. Where the sag is greater than that permitted in the FL_b range, the application is critical and should be avoided. The self-supporting length can be optimized by using a support for the upper run or a more stable cable drag chain.

DETERMINING THE CHAIN LENGTH

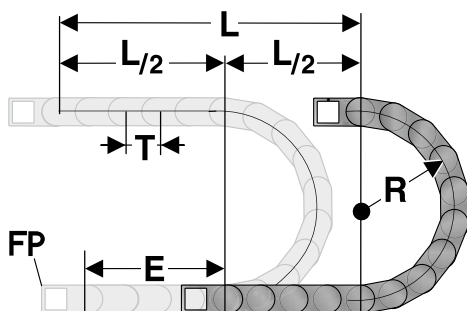

The fixed point of the cable drag chain should be connected in the middle of the travel distance.
 This arrangement gives the shortest connection between the fixed point (FP) and the moving bracket and thus the most efficient chain length.

Chain length calculation = $L/2 + \pi * R + E$
 $\approx 1 \text{ ft chain} = 4 \text{ qty.} \times 2.97 \text{ inch.}$

- E = Distance between entry point and middle of travel distance
- L = Travel distance
- R = Radius
- P = Grid 2.97 inch

INSTALLATION DIMENSIONS

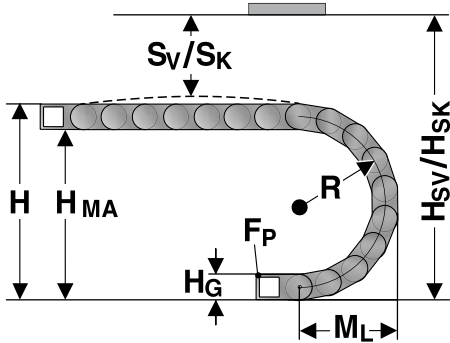

The moving end chain connection is to be screw fixed at height H_{MA} for the respective radius.

Concerning the installed dimensions, you must take into account whether the chain links are equipped with or without bias. For chain links without bias, the “Installed height without bias H_{SK} ” value has to be taken into account.

If the chain links are equipped with a bias, the value “Installed height with bias H_{SV} ” has to be taken into account.

Radius R	4.92	5.91	7.87	9.84	11.81	15.75
Outside height of chain link (H_G)	2.44	2.44	2.44	2.44	2.44	2.44
Height of bend (H)	12.28	14.26	18.18	22.12	26.06	33.94
Height of moving end connection (H_{MA})	9.84	11.82	15.74	19.68	23.62	31.50
Safety margin with bias (S_V)	1.50	1.50	1.50	1.50	1.50	1.50
Installation height with bias (H_{SV})	13.78	15.76	19.68	23.62	27.56	35.44
Safety margin without bias (S_K)	0.51	0.51	0.51	0.51	0.51	0.51
Installation height without bias (H_{SK})	12.79	14.77	18.69	22.63	26.57	34.45
Arc projection (M_L)	9.11	10.10	12.06	14.03	16.00	19.94

KA 44 CHAIN BRACKET ANGLE

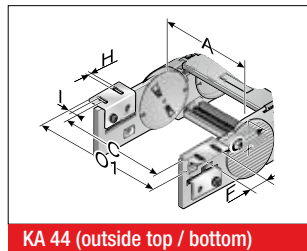
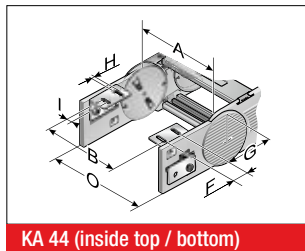

There are several options regarding the chain bracket. The fixed-point bracket (inside/bottom) and the moving end bracket (inside/top) are supplied as standard. However, any other combination can be supplied upon request. The chain bracket is fastened at the end like a side link. This enables the chain to move right up to the bracket. Each chain requires two chain brackets. The brackets should be fastened with M6 screws.

Type	Order No.	Material	Inside width								Outside width of KA 0	Outside width of KA 01	
			A inch	B inch	C inch	E inch	F inch	G inch	G1 inch	H0 inch			I inch
KA 44	0440000050	Sheet steel	2.44 – 7.17	A-0.57	A+1.52	A+1.26	1.26	1.70	3.39	0.26	0.49	A+1.30	A+2.52
KA 44	0440000052	Stainless steel 1.4301	2.44 – 7.17	A-0.57	A+1.52	A+1.26	1.26	1.70	3.39	0.26	0.49	A+1.30	A+2.52

MP 43G CLOSED

TR 43G SEPARATOR

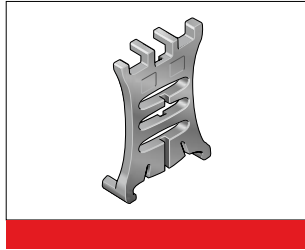
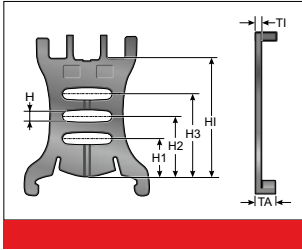

We recommend that separators be used if multiple round cables or conduits with differing diameters are to be installed.

Type	Order No.	Description	Version	TI inch	TA inch	H inch	H1 inch	H2 inch	H3 inch	HI inch
TF 43	0430000090	Separator	movable	0.16	0.35	0.17	0.48	0.77	1.04	1.50

MP 43G SHELVING SYSTEM

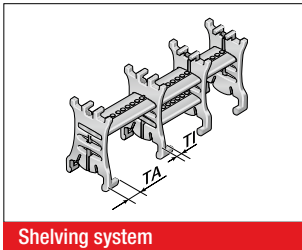

Shelving system

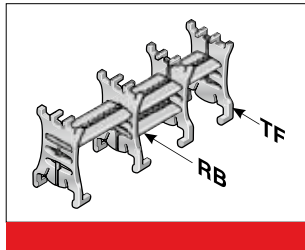

The shelf must be used with a minimum of two separators to create a shelving system. The additional levels prevent cables from criss-crossing and minimize the friction between them. The shelves are matched to the available chain widths.

Type	Order No.	Description	Width inch	Clearance width inch	Lock grid spacing inch
RB 031	100000003100	Shelf	1.65	1.22	0.06
RB 048	100000004800	Shelf	2.32	1.89	0.06
RB 070	100000007000	Shelf	3.19	2.76	0.06
RB 092	100000009200	Shelf	4.06	3.62	0.06
RB 128	100000012800	Shelf	5.47	5.04	0.06
RB 167	100000016700	Shelf	7.01	6.57	0.06

VAW GUIDE CHANNEL

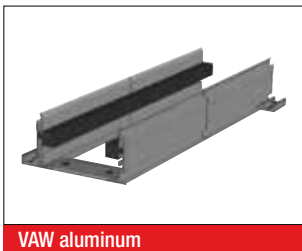

VAW aluminum

A variable guide channel system, constructed from aluminum sections, is available for this cable drag chain. The variable guide channel ensures that the cable drag chain is supported and guided securely.

ASSEMBLY

DISASSEMBLY

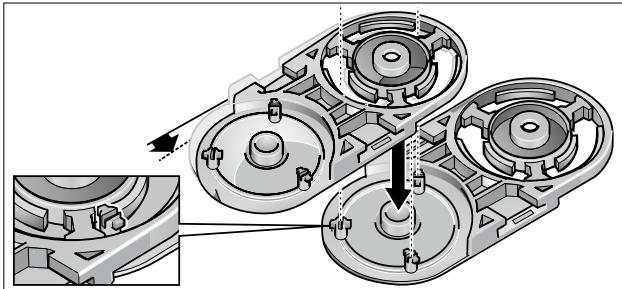

Step 1

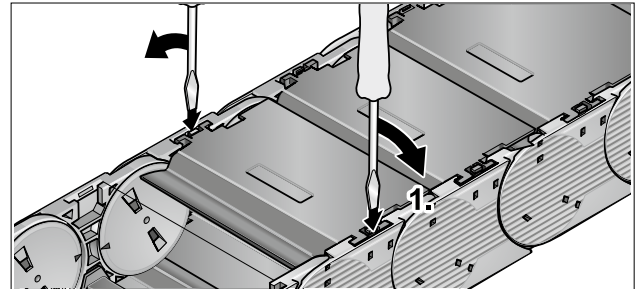

Step 1

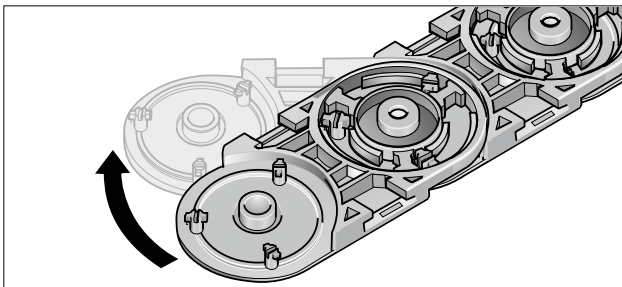

Step 2

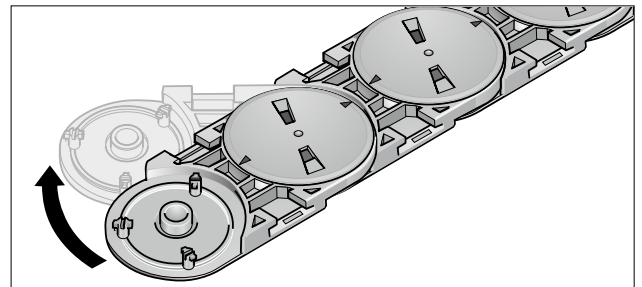

Step 2

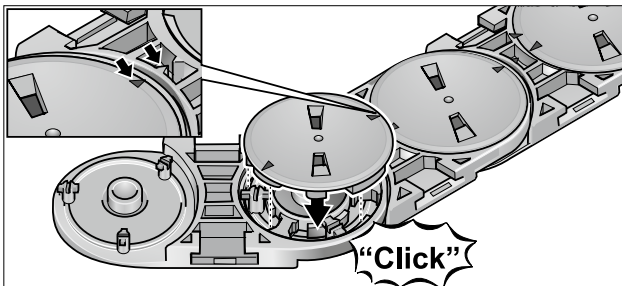

Step 3

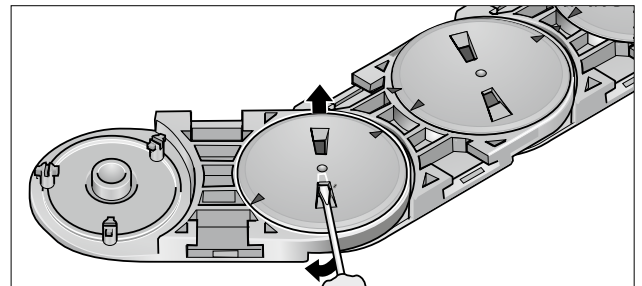

Step 3

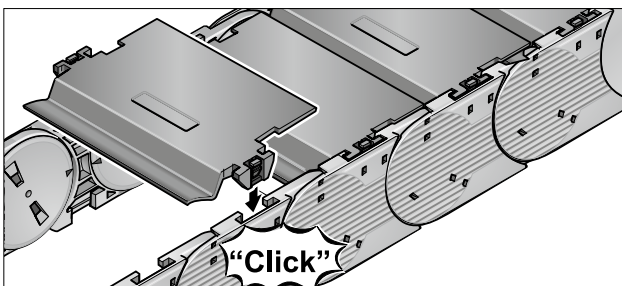

Step 4

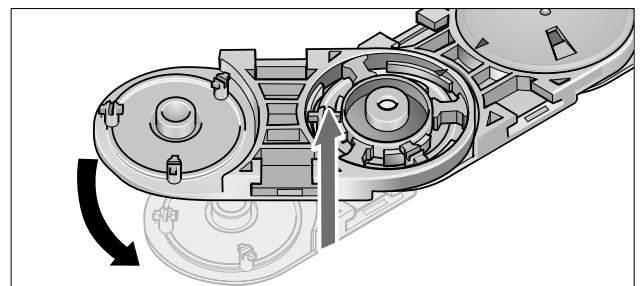

Step 4

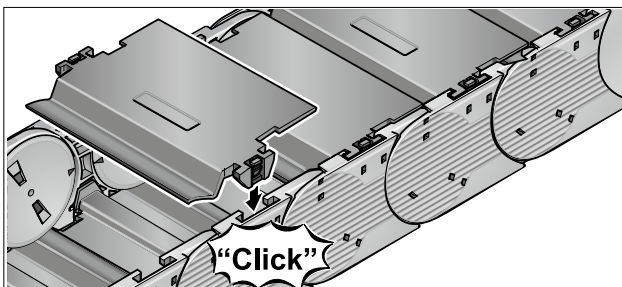

Step 5

MP 45.1
OPEN



MP 45.2
OPEN



- LOW-COST VARIANT
- SOFT-STOP SYSTEM
- SUITABLE FOR UNIVERSAL USE
- CHAIN BRACKET WITH INTEGRATED STRAIN RELIEF
- BROAD INTERIOR LAYOUT

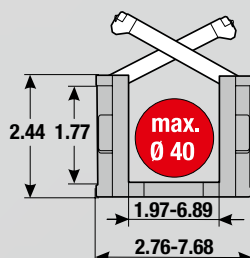

TECHNICAL DATA

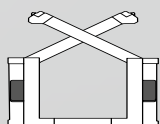

Loading side
Inside or outside bend

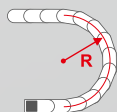

Available radii
2.95 – 11.81 inch



Available interior widths
With plastic crossbar
1.97 – 6.98 inch

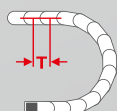

Grid
T = 2.64 inch



Noise attenuator
Reduction of the noise emission by up to 10 dB(A) by the use of damping elements in the chain links.





TECHNICAL SPECIFICATIONS

Travel distance gliding L_g max.	262.47 ft.
Travel distance self-supporting L_s max.	see diagram on page 145
Travel distance vertical, hanging L_{vh} max.	196.85 ft.
Travel distance vertical, upright L_{vs} max.	13.12 ft.
Rotated 90°, unsupported L_{90f} max.	3.28 ft.
Speed, gliding V_g max.	16.40 ft/s
Speed, self-supporting V_f max.	65.62 ft/s
Acceleration, gliding a_g max.	49.21 ft/s ²
Acceleration, self-supporting a_s max.	164.04 ft/s ²

Contact our engineering department to meet any higher requirements: efk@murrplastik.de

MATERIAL PROPERTIES

Standard material	Polyamide (PA) black
Service temperature	-22.00 – 248.00 °F
Gliding friction factor	0.30
Static friction factor	0.45
Fire classification	UL 94 HB

Other material properties on request

CHAIN BRACKET

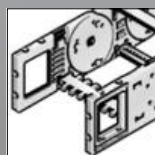

Chain bracket flexible

SHELVING SYSTEM

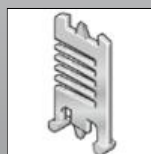

Separator TR



RS shelving system

GUIDE CHANNELS



VAW steel galvanized / stainless steel

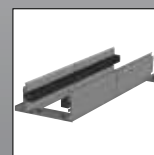

VAW aluminum

STRAIN RELIEF

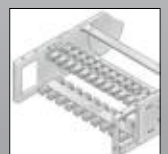

RS-ZL crossbar strain relief



STF Steel Fix

ORDERING KEY

Dimensions in mm [US inch]

Type code	Variation	Inside width	Outside width	Inside width	Outside width	Radius	Rail variant	Material	Chain length																																																																																																		
0451 01	MP 45.1 open Crossbar on outside bend Crossbar on inside bend Opens on outside bend	050 [1.97]	070 [2.76]			075 [2.95]	0 Plastic, full-ridged with bias	2 Polyamide without attenuator (PA/black)																																																																																																			
		075 [2.95]	095 [3.74]							0452 02	MP 45.2 open Crossbar on outside bend Crossbar on inside bend Opens on inside of bend	100 [3.94]	120 [4.72]			100 [3.94]	1 Plastic, full-ridged without bias	3 Polyamide with attenuator (PA/black)		115 [4.53]	135 [5.31]					125 [4.92]	145 [5.71]			125 [4.92]		9 Special version (on request)				150 [5.91]	170 [6.69]			150 [5.91]						175 [6.89]	195 [7.68]													200 [7.87]																				250 [9.84]																				300 [11.81]							
0452 02	MP 45.2 open Crossbar on outside bend Crossbar on inside bend Opens on inside of bend	100 [3.94]	120 [4.72]			100 [3.94]	1 Plastic, full-ridged without bias	3 Polyamide with attenuator (PA/black)																																																																																																			
		115 [4.53]	135 [5.31]									125 [4.92]	145 [5.71]			125 [4.92]		9 Special version (on request)				150 [5.91]	170 [6.69]			150 [5.91]						175 [6.89]	195 [7.68]													200 [7.87]																				250 [9.84]																				300 [11.81]																					
		125 [4.92]	145 [5.71]			125 [4.92]		9 Special version (on request)																																																																																																			
		150 [5.91]	170 [6.69]			150 [5.91]																																																																																																					
		175 [6.89]	195 [7.68]																																																																																																								
						200 [7.87]																																																																																																					
						250 [9.84]																																																																																																					
						300 [11.81]																																																																																																					

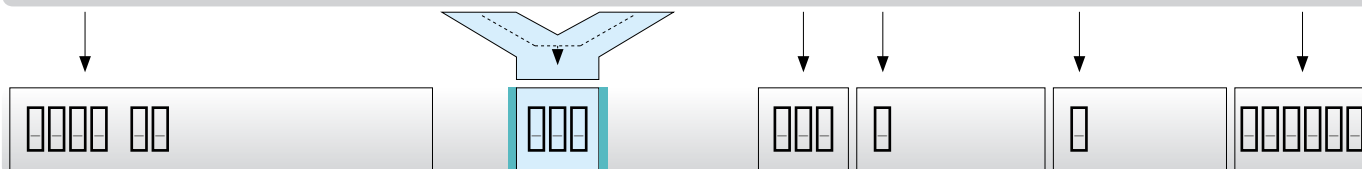

ORDERING EXAMPLE: 0452 02 075 100 0 3 2000

Crossbar on outside bend, crossbar on inside bend, can be opened from inside bend
 Inside width 2.95 in. (075 mm), radius 3.94 in. (100 mm)
 Plastic, full-ridged with bias, material polyamide with damper (PA/black)
 Chain length 78.74 in. (2000 mm) (30 links)

SELF-SUPPORTING LENGTH

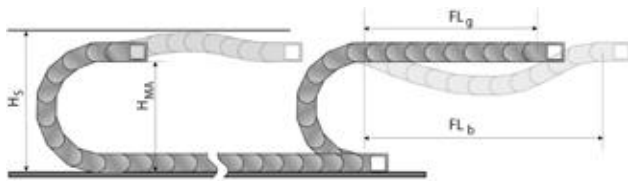

The self-supporting length is the distance between the chain bracket on the moving end and the start of the chain arch.
 The installation variant FL_g offers the lowest load and wear for the cable drag chain.
 The maximum travel parameters (speed and acceleration) can be applied for this variant.

- H_s = Installation height plus safety
- H_{MA} = Height of moving end connection
- FL_g = Self-supporting length, upper run straight
- FL_b = Self-supporting length, upper run bent

LOAD DIAGRAM FOR SELF-SUPPORTING APPLICATIONS

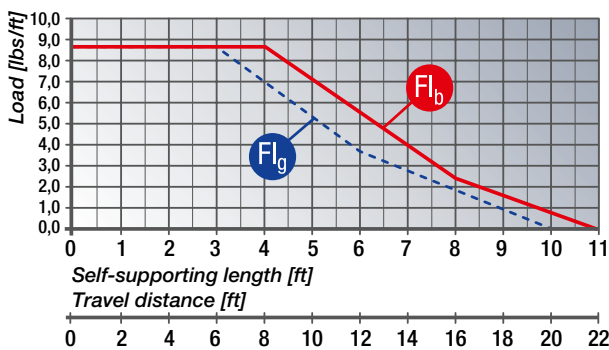

FL_g Self-supporting length, upper run straight
 In the FL_g range, the chain upper run still has a bias, is straight or has a maximum sag of 1.97 inch.

FL_b Self-supporting length, upper run bent
 In the FL_b range, the chain upper run has a sag of more than 1.97 inch, but this is still less than the maximum sag. Where the sag is greater than that permitted in the FL_b range, the application is critical and should be avoided. The self-supporting length can be optimized by using a support for the upper run or a more stable cable drag chain.

DETERMINING THE CHAIN LENGTH

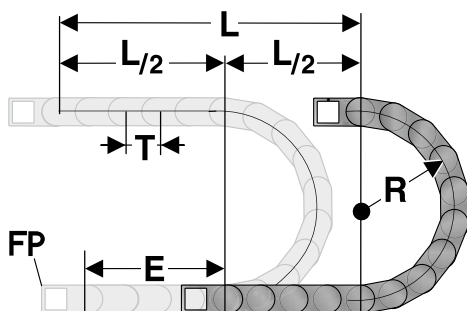

The fixed point of the cable drag chain should be connected in the middle of the travel distance.
 This arrangement gives the shortest connection between the fixed point (FP) and the moving bracket and thus the most efficient chain length.

Chain length calculation = $L/2 + \pi * R + E$
 $\approx 1 \text{ ft chain} = 5 \text{ qty.} \times 2.64 \text{ inch.}$

- E = Distance between entry point and middle of travel distance
- L = Travel distance
- R = Radius
- P = Grid 2.64 inch

INSTALLATION DIMENSIONS

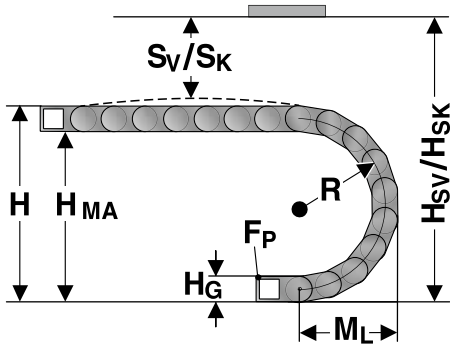

The moving end chain connection is to be screw fixed at height H_{MA} for the respective radius.

Concerning the installation dimensions take into consideration, whether the chain links are equipped with damping elements or not.

For chain links without damping elements, the value “Installed height with bias H_{SV} without damper” or “Installed height without bias H_{SK} without damper” must be taken into account.

If the chain links are equipped with a damping element, the value “Installed height with bias H_{SV} with damper” or “Installed height without bias H_{SK} with damper” is to be taken into account.

Radius R	75	100	125	150	200	250	300
Outside height of chain link (H_G)	2.44	2.44	2.44	2.44	2.44	2.44	2.44
Height of bend (H)	152.44	202.44	252.44	302.44	402.44	502.44	602.44
Height of moving end connection (H_{MA})	150.00	200.00	250.00	300.00	400.00	500.00	600.00
Safety margin with bias (S_V)	0.79	0.79	0.79	0.79	0.79	0.79	0.79
Installation height with bias (H_{SV}) without damper	156.77	206.77	256.77	306.77	406.77	506.77	606.77
Installation height with bias (H_{SV}) with damper	157.56	207.56	257.56	307.56	407.56	507.56	607.56
Safety margin without bias (S_K)	0.79	0.79	0.79	0.79	0.79	0.79	0.79
Installation height without bias (H_{SK}) without damper	153.23	203.23	253.23	303.23	403.23	503.23	603.23
Installation height without bias (H_{SK}) with damper	154.02	204.02	254.02	304.02	404.02	504.02	604.02
Arc projection (M_L)	78.86	103.86	128.86	153.86	203.86	253.86	303.86

DAMPING ELEMENT FOR THE CHAIN LINKS

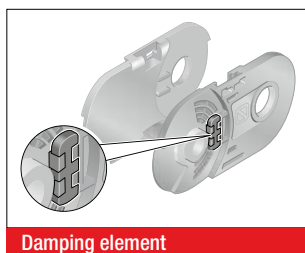

The dampening elements in the stops make for a significantly quieter unrolling of the chain links. The dampers can be chosen optionally.

A reduction of the noise emission by up to 10 dB(A) comparing to the variants without the use of damping elements is possible.

KA 45 CHAIN BRACKET FLEXIBLE

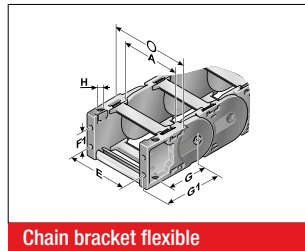
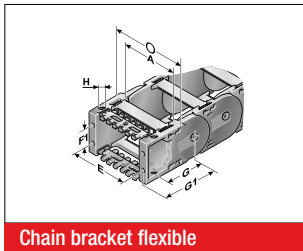

This chain bracket offers universal connection options (top, bottom and front) and is attached to the ends of the cable drag chain like a side link. This allows the chain to move right up to the bracket. Each cable drag chain requires one male and one female bracket. M5 screws are used to secure the brackets in place. Press-in metal bushes with a through-hole ensure the permanent, high-strength transmission of even extreme forces onto the cable drag chain.

By default, the chain bracket is supplied with crossbars. The chain bracket can then be optionally fitted with crossbar strain relief plates (RS-ZL) or with strain relief using C-rails and type STF bow clamps.

Type	Order No.	Material	Inside width						Outside width of KA O
			A inch	E inch	F1 inch	G inch	G1 inch	H0 inch	
KA 45-FB Female end, 050, complete	0450005050	Plastic	1.97	A+0.51	0.87	2.36	3.23	0.22	A+0.94
KA 45-FB Female end, 050, pendular, complete	0450005052	Plastic	1.97	A+0.51	0.87	2.36	3.23	0.22	A+0.94
KA 45-FB Male end, 050, complete	0450005051	Plastic	1.97	A+0.51	0.87	2.36	3.23	0.22	A+0.94
KA 45-FB Male end, 050, pendular, complete	0450005053	Plastic	1.97	A+0.51	0.87	2.36	3.23	0.22	A+0.94
KA 45-FB Female end, 075, complete	0450007550	Plastic	2.95	A+0.51	0.87	2.36	3.23	0.22	A+0.94
KA 45-FB Female end, 075, pendular, complete	0450007552	Plastic	2.95	A+0.51	0.87	2.36	3.23	0.22	A+0.94
KA 45-FB Male end, 075, complete	0450007551	Plastic	2.95	A+0.51	0.87	2.36	3.23	0.22	A+0.94
KA 45-FB Male end, 075, pendular, complete	0450007553	Plastic	2.95	A+0.51	0.87	2.36	3.23	0.22	A+0.94
KA 45-FB Female end, 100, complete	0450010050	Plastic	3.94	A+0.51	0.87	2.36	3.23	0.22	A+0.94
KA 45-FB Female end, 100, pendular, complete	0450010052	Plastic	3.94	A+0.51	0.87	2.36	3.23	0.22	A+0.94
KA 45-FB Male end, 100, complete	0450010051	Plastic	3.94	A+0.51	0.87	2.36	3.23	0.22	A+0.94
KA 45-FB Male end, 100, pendular, complete	0450010053	Plastic	3.94	A+0.51	0.87	2.36	3.23	0.22	A+0.94
KA 45-FB Female end, 115, complete	0450011550	Plastic	4.53	A+0.51	0.87	2.36	3.23	0.22	A+0.94
KA 45-FB Female end, 115, pendular, complete	0450011552	Plastic	4.53	A+0.51	0.87	2.36	3.23	0.22	A+0.94
KA 45-FB Male end, 115, complete	0450011551	Plastic	4.53	A+0.51	0.87	2.36	3.23	0.22	A+0.94
KA 45-FB Male end, 115, pendular, complete	0450011553	Plastic	4.53	A+0.51	0.87	2.36	3.23	0.22	A+0.94
KA 45-FB Female end, 125, complete	0450012550	Plastic	4.92	A+0.51	0.87	2.36	3.23	0.22	A+0.94
KA 45-FB Female end, 125, pendular, complete	0450012552	Plastic	4.92	A+0.51	0.87	2.36	3.23	0.22	A+0.94
KA 45-FB Male end, 125, complete	0450012551	Plastic	4.92	A+0.51	0.87	2.36	3.23	0.22	A+0.94
KA 45-FB Male end, 125, pendular, complete	0450012553	Plastic	4.92	A+0.51	0.87	2.36	3.23	0.22	A+0.94
KA 45-FB Female end, 150, complete	0450015050	Plastic	5.91	A+0.51	0.87	2.36	3.23	0.22	A+0.94
KA 45-FB Female end, 150, pendular, complete	0450015052	Plastic	5.91	A+0.51	0.87	2.36	3.23	0.22	A+0.94
KA 45-FB Male end, 150, complete	0450015051	Plastic	5.91	A+0.51	0.87	2.36	3.23	0.22	A+0.94
KA 45-FB Male end, 150, pendular, complete	0450015053	Plastic	5.91	A+0.51	0.87	2.36	3.23	0.22	A+0.94
KA 45-FB Female end, 175, complete	0450017550	Plastic	6.89	A+0.51	0.87	2.36	3.23	0.22	A+0.94
KA 45-FB Female end, 175, pendular, complete	0450017552	Plastic	6.89	A+0.51	0.87	2.36	3.23	0.22	A+0.94
KA 45-FB Male end, 175, complete	0450017551	Plastic	6.89	A+0.51	0.87	2.36	3.23	0.22	A+0.94
KA 45-FB Male end, 175, pendular, complete	0450017553	Plastic	6.89	A+0.51	0.87	2.36	3.23	0.22	A+0.94
KA 45-FG Female end, 050, complete	0450005054	Plastic	1.97	A+0.51	0.87	2.36	3.23	0.22	A+0.94
KA 45-FG Female end, 050, pendular, complete	0450005056	Plastic	1.97	A+0.51	0.87	2.36	3.23	0.22	A+0.94
KA 45-FG Male end, 050, complete	0450005055	Plastic	1.97	A+0.51	0.87	2.36	3.23	0.22	A+0.94
KA 45-FG Male end, 050, pendular, complete	0450005057	Plastic	1.97	A+0.51	0.87	2.36	3.23	0.22	A+0.94
KA 45-FG Female end, 075, complete	0450007554	Plastic	2.95	A+0.51	0.87	2.36	3.23	0.22	A+0.94

KA 45 CHAIN BRACKET FLEXIBLE

Type	Order No.	Material	Inside width							Outside width of KA 0
			A inch	E inch	F1 inch	G inch	G1 inch	H0 inch		
KA 45-FG Female end, 075, pendular, complete	0450007556	Plastic	2.95	A+0.51	0.87	2.36	3.23	0.22	A+0.94	
KA 45-FG Male end, 075, complete	0450007555	Plastic	2.95	A+0.51	0.87	2.36	3.23	0.22	A+0.94	
KA 45-FG Male end, 075, pendular, complete	0450007557	Plastic	2.95	A+0.51	0.87	2.36	3.23	0.22	A+0.94	
KA 45-FG Female end, 100, complete	0450010054	Plastic	3.94	A+0.51	0.87	2.36	3.23	0.22	A+0.94	
KA 45-FG Female end, 100, pendular, complete	0450010056	Plastic	3.94	A+0.51	0.87	2.36	3.23	0.22	A+0.94	
KA 45-FG Male end, 100, complete	0450010055	Plastic	3.94	A+0.51	0.87	2.36	3.23	0.22	A+0.94	
KA 45-FG Male end, 100, pendular, complete	0450010057	Plastic	3.94	A+0.51	0.87	2.36	3.23	0.22	A+0.94	
KA 45-FG Female end, 115, complete	0450011554	Plastic	4.53	A+0.51	0.87	2.36	3.23	0.22	A+0.94	
KA 45-FG Female end, 115, pendular, complete	0450011556	Plastic	4.53	A+0.51	0.87	2.36	3.23	0.22	A+0.94	
KA 45-FG Male end, 115, complete	0450011555	Plastic	4.53	A+0.51	0.87	2.36	3.23	0.22	A+0.94	
KA 45-FG Male end, 115, pendular, complete	0450011557	Plastic	4.53	A+0.51	0.87	2.36	3.23	0.22	A+0.94	
KA 45-FG Female end, 125, complete	0450012554	Plastic	4.92	A+0.51	0.87	2.36	3.23	0.22	A+0.94	
KA 45-FG Female end, 125, pendular, complete	0450012556	Plastic	4.92	A+0.51	0.87	2.36	3.23	0.22	A+0.94	
KA 45-FG Male end, 125, complete	0450012555	Plastic	4.92	A+0.51	0.87	2.36	3.23	0.22	A+0.94	
KA 45-FG Male end, 125, pendular, complete	0450012557	Plastic	4.92	A+0.51	0.87	2.36	3.23	0.22	A+0.94	
KA 45-FG Female end, 150, complete	0450015054	Plastic	5.91	A+0.51	0.87	2.36	3.23	0.22	A+0.94	
KA 45-FG Female end, 150, pendular, complete	0450015056	Plastic	5.91	A+0.51	0.87	2.36	3.23	0.22	A+0.94	
KA 45-FG Male end, 150, complete	0450015055	Plastic	5.91	A+0.51	0.87	2.36	3.23	0.22	A+0.94	
KA 45-FG Male end, 150, pendular, complete	0450015057	Plastic	5.91	A+0.51	0.87	2.36	3.23	0.22	A+0.94	
KA 45-FG Female end, 175, complete	0450017554	Plastic	6.89	A+0.51	0.87	2.36	3.23	0.22	A+0.94	
KA 45-FG Female end, 175, pendular, complete	0450017556	Plastic	6.89	A+0.51	0.87	2.36	3.23	0.22	A+0.94	
KA 45-FG Male end, 175, complete	0450017555	Plastic	6.89	A+0.51	0.87	2.36	3.23	0.22	A+0.94	
KA 45-FG Male end, 175, pendular, complete	0450017557	Plastic	6.89	A+0.51	0.87	2.36	3.23	0.22	A+0.94	

TRT 45 DIVISIBLE SEPARATOR

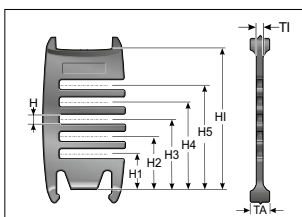

Separator

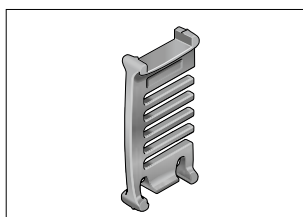

Separator

We recommend that separators be used if multiple round cables or conduits with differing diameters are to be installed.

Type	Order No.	Description	Version	TI inch	TA inch	H inch	H1 inch	H2 inch	H3 inch	H4 inch	H5 inch	HI inch
TRT 45	045000009200	TRT 45, separator, divisible	lockable	0.12	0.31	0.13	0.44	0.67	0.89	1.11	1.33	1.77

TR 45-V SEPARATOR

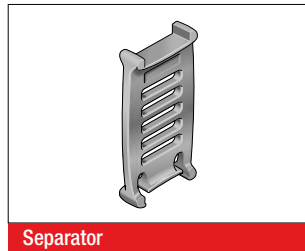
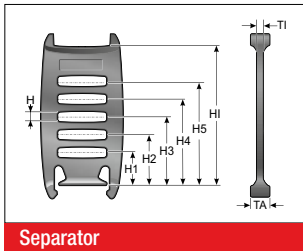

We recommend that separators be used if multiple round cables or conduits with differing diameters are to be installed.

Type	Order No.	Description	Version	TI inch	TA inch	H inch	H1 inch	H2 inch	H3 inch	H4 inch	H5 inch	HI inch
TR 45-V	045000009300	TR 45-V Separator	movable	0.12	0.31	0.13	0.44	0.67	0.89	1.11	1.33	1.77

RTT 45 SHELF SUPPORT, DIVISIBLE

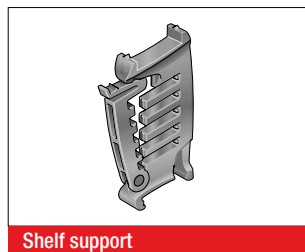
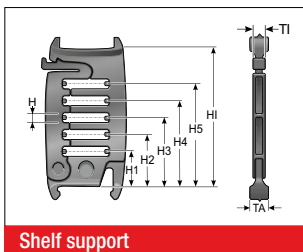

In connection with two separable shelf supports (RTT) with at least one end-to-end shelf (RB) the shelf becomes an easy to fill shelving system. The additional levels prevent cables from criss-crossing and minimize the friction between them.

Type	Order No.	Description	Version	TI inch	TA inch	H inch	H1 inch	H2 inch	H3 inch	H4 inch	H5 inch	HI inch
RTT 45	100090450000	Shelf support, divisible	lockable	0.20	0.31	0.13	0.44	0.67	0.89	1.11	1.33	1.77

RB-3 SHELF

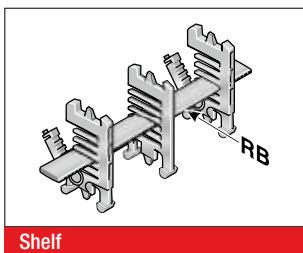

In connection with at least two separable shelf supports (RTT), the shelf becomes a shelving system. The additional levels prevent cables from criss-crossing and minimize the friction between them.

Type	Order No.	Description	Width inch	Inside width inch
RB 039-3	030100003900	Shelf	1.52	1.57
RB 041-3	1000004103	Shelf	1.62	1.97
RB 044-3	1000004403	Shelf	1.72	1.97

RB-3 SHELF

Type	Order No.	Description	Width inch	Inside width inch
RB 046-3	1000004603	Shelf	1.81	1.97
RB 049-3	030100004900	Shelf	1.91	1.97
RB 051-3	1000005103	Shelf	2.01	2.36
RB 054-3	1000005403	Shelf	2.11	2.36
RB 056-3	1000005603	Shelf	2.21	2.36
RB 059-3	030100005900	Shelf	2.31	2.36
RB 061-3	1000006103	Shelf	2.41	2.95
RB 064-3	1000006403	Shelf	2.50	2.95
RB 066-3	1000006603	Shelf	2.60	2.95
RB 069-3	1000006903	Shelf	2.70	2.95
RB 071-3	1000007103	Shelf	2.80	2.95
RB 074-3	030100007400	Shelf	2.90	2.95
RB 076-3	1000007603	Shelf	3.00	3.35
RB 079-3	1000007903	Shelf	3.09	3.35
RB 081-3	1000008103	Shelf	3.19	3.35
RB 084-3	030100008400	Shelf	3.29	3.35
RB 086-3	1000008603	Shelf	3.39	3.94
RB 089-3	1000008903	Shelf	3.49	3.94
RB 091-3	1000009103	Shelf	3.59	3.94
RB 094-3	1000009403	Shelf	3.69	3.94
RB 096-3	1000009603	Shelf	3.78	3.94
RB 099-3	030100009900	Shelf	3.88	3.94
RB 101-3	1000010103	Shelf	3.98	4.53
RB 104-3	1000010403	Shelf	4.08	4.53
RB 106-3	1000010603	Shelf	4.18	4.53
RB 109-3	1000010903	Shelf	4.28	4.53
RB 111-3	1000011103	Shelf	4.37	4.53
RB 114-3	030100011400	Shelf	4.47	4.53
RB 116-3	1000011603	Shelf	4.57	4.92
RB 119-3	1000011903	Shelf	4.67	4.92
RB 121-3	1000012103	Shelf	4.77	4.92
RB 124-3	030100012400	Shelf	4.87	4.92
RB 126-3	1000012603	Shelf	4.96	5.91
RB 129-3	1000012903	Shelf	5.06	5.91
RB 131-3	1000013103	Shelf	5.16	5.91
RB 134-3	1000013403	Shelf	5.26	5.91
RB 136-3	1000013603	Shelf	5.36	5.91
RB 139-3	1000013903	Shelf	5.46	5.91
RB 141-3	1000014103	Shelf	5.56	5.91
RB 144-3	1000014403	Shelf	5.65	5.91
RB 146-3	1000014603	Shelf	5.75	5.91
RB 149-3	030100014900	Shelf	5.85	5.91
RB 151-3	1000015103	Shelf	5.95	6.89
RB 154-3	1000015403	Shelf	6.05	6.89

RB-3 SHELF

Type	Order No.	Description	Width inch	Inside width inch
RB 156-3	1000015603	Shelf	6.15	6.89
RB 159-3	1000015903	Shelf	6.24	6.89
RB 161-3	1000016103	Shelf	6.34	6.89
RB 164-3	1000016403	Shelf	6.44	6.89
RB 166-3	1000016603	Shelf	6.54	6.89
RB 169-3	1000016903	Shelf	6.64	6.89
RB 174-3	030100017400	Shelf	6.83	6.89
RB 176-3	1000017603	Shelf	6.93	7.87
RB 179-3	1000017903	Shelf	7.03	7.87
RB 181-3	1000018103	Shelf	7.13	7.87
RB 184-3	1000018403	Shelf	7.23	7.87
RB 186-3	1000018603	Shelf	7.33	7.87
RB 189-3	1000018903	Shelf	7.43	7.87
RB 191-3	1000019103	Shelf	7.52	7.87
RB 194-3	1000019403	Shelf	7.62	7.87
RB 196-3	1000019603	Shelf	7.72	7.87
RB 199-3	030100019900	Shelf	7.82	7.87

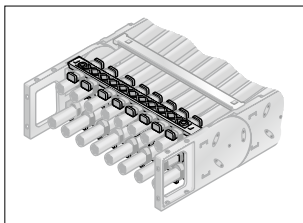
RS-ZL-3 ZLA MP 45 CROSSBAR STRAIN RELIEF PLATE

Crossbar strain relief plate

Fixed integrated crossbar strain relief plates in the chain brackets. Tailored to all crossbars widths up to 6.89 inch (175 mm). May be assembled on the inside and outside bends at both chain endings.

Type	Order No.	Description	Inside width inch
RS-ZL 050-3 ZLA MP 45	0451050010	Crossbar strain relief plate	1.97
RS-ZL 075-3 ZLA MP 45	0451075010	Crossbar strain relief plate	2.95
RS-ZL 100-3 ZLA MP 45	0451100010	Crossbar strain relief plate	3.94
RS-ZL 115-3 ZLA MP 45	0451115010	Crossbar strain relief plate	4.53
RS-ZL 125-3 ZLA MP 45	0451125010	Crossbar strain relief plate	4.92
RS-ZL 150-3 ZLA MP 45	0451150010	Crossbar strain relief plate	5.91
RS-ZL 175-3 ZLA MP 45	0451175010	Crossbar strain relief plate	6.89

STRAIN RELIEF WITH STEEL FIX

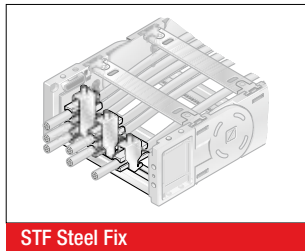
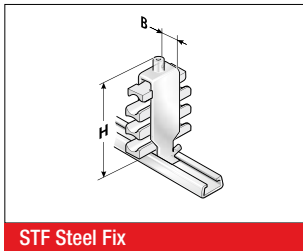

C-rails (galvanized) for permanent integration, for accommodating the Steel Fix bow clamps in the chain brackets. The bow clamps can take up to 3 cables and are suitable for C-rails with a groove width of 0.43 in (11 mm). Due to the design of the trough elements, a cable preserving cable guidance is ensured. May be assembled on the inside and outside bends at both chain endings. The overall height stated is a guide only. The actual height is, amongst other things, dependent on the diameter and the quality of the cable. A safety distance of 0.39 in (10 mm) at the fixed point above the strain relief must be kept during gliding applications.

Type	Order No.	Description	Seats qty.	Cable Ø inch	Width (B) inch	Total height (H) inch
Single clamp (for one cable)						
STF 12-1 Steel Fix	81661801	Hooped clamp	1	0.24 – 0.47	0.63	2.17
STF 14-1 Steel Fix	81661802	Hooped clamp	1	0.47 – 0.55	0.71	2.05
STF 16-1 Steel Fix	81661803	Hooped clamp	1	0.55 – 0.63	0.79	2.13
STF 18-1 Steel Fix	81661804	Hooped clamp	1	0.63 – 0.71	0.87	2.20
STF 20-1 Steel Fix	81661805	Hooped clamp	1	0.71 – 0.79	0.94	2.32
STF 22-1 Steel Fix	81661806	Hooped clamp	1	0.79 – 0.87	1.02	2.40
STF 26-1 Steel Fix	81661807	Hooped clamp	1	0.87 – 1.02	1.18	2.76
STF 30-1 Steel Fix	81661808	Hooped clamp	1	1.02 – 1.18	1.34	2.91
STF 34-1 Steel Fix	81661809	Hooped clamp	1	1.18 – 1.34	1.50	3.07
STF 38-1 Steel Fix	81661810	Hooped clamp	1	1.34 – 1.50	1.65	3.23
STF 42-1 Steel Fix	81661811	Hooped clamp	1	1.50 – 1.65	1.81	3.58
Double clamp (for two cables)						
STF 12-2 Steel Fix	81661821	Hooped clamp	2	0.24 – 0.47	0.63	2.87
STF 14-2 Steel Fix	81661822	Hooped clamp	2	0.47 – 0.55	0.71	2.91
STF 16-2 Steel Fix	81661823	Hooped clamp	2	0.55 – 0.63	0.79	3.23
STF 18-2 Steel Fix	81661824	Hooped clamp	2	0.63 – 0.71	0.87	3.39
STF 20-2 Steel Fix	81661825	Hooped clamp	2	0.71 – 0.79	0.94	3.58
STF 22-2 Steel Fix	81661826	Hooped clamp	2	0.79 – 0.87	1.02	3.74
STF 26-2 Steel Fix	81661827	Hooped clamp	2	0.87 – 1.02	1.18	4.25
STF 30-2 Steel Fix	81661828	Hooped clamp	2	1.02 – 1.18	1.34	4.76
STF 34-2 Steel Fix	81661829	Hooped clamp	2	1.18 – 1.34	1.50	5.08
Triple clamp (for three cables)						
STF 12-3 Steel Fix	81661841	Hooped clamp	3	0.24 – 0.47	0.63	3.86
STF 14-3 Steel Fix	81661842	Hooped clamp	3	0.47 – 0.55	0.71	3.86
STF 16-3 Steel Fix	81661843	Hooped clamp	3	0.55 – 0.63	0.79	4.13
STF 18-3 Steel Fix	81661844	Hooped clamp	3	0.63 – 0.71	0.87	4.37
STF 20-3 Steel Fix	81661845	Hooped clamp	3	0.71 – 0.79	0.94	4.65
STF 22-3 Steel Fix	81661846	Hooped clamp	3	0.79 – 0.87	1.02	5.12

GUIDE CHANNEL VAW (ALUMINUM / STAINLESS STEEL)



A range of variable guide channel systems, constructed from aluminum or stainless steel sections, is available for this cable drag chain.

The variable guide channel ensures that the cable drag chain is supported and guided securely.

LOWERED FIXING POINT MP 45

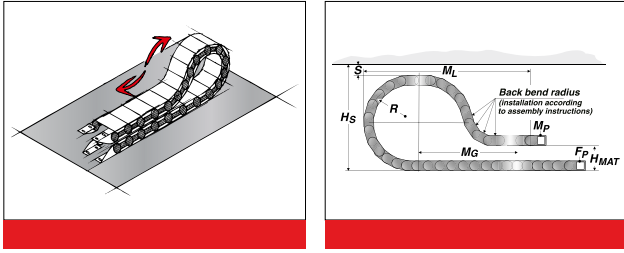

It is sometimes necessary to lower the height of the moving attachment point.
 In such cases, modifications to the chain layout should be noted (e.g. extension of chain).
 Please contact our application engineers.

Radius R inch	Height of moving end connection (H _{MA}) inch	Safety margin (S) inch	Installation height incl. safety (H _i) inch	Projection (M ₁) inch	Additional links qty.	of which additional back chain links qty.
5.91	7.87	1.97	16.22	24.80	12	3
7.87	7.87	1.97	20.16	29.92	13	3
9.84	7.87	1.97	24.09	36.61	18	4
11.81	7.87	1.97	28.03	42.52	20	4

ASSEMBLY

DISASSEMBLY

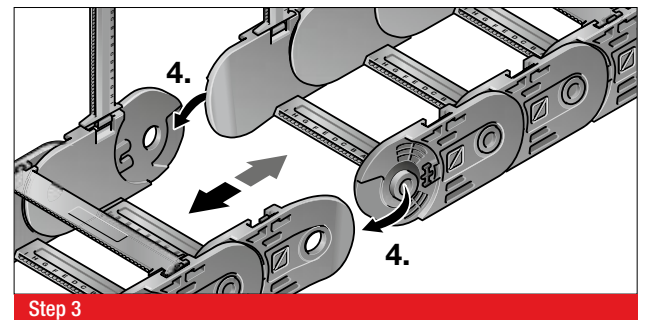
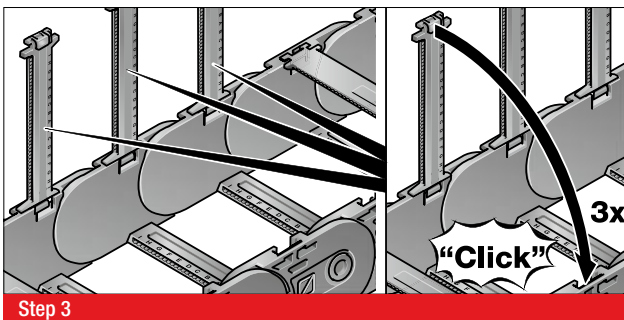
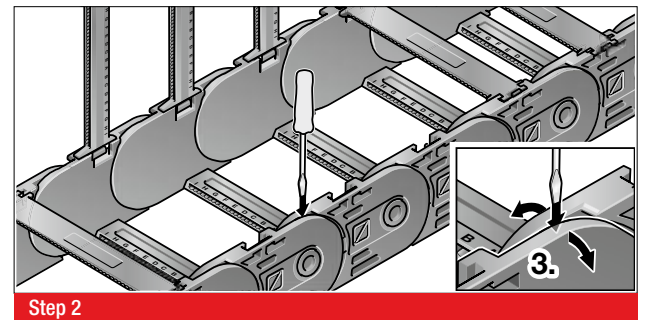
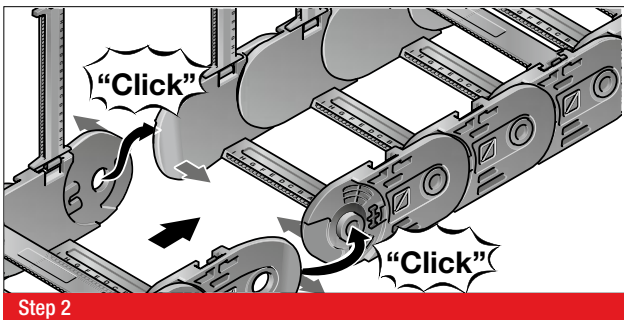
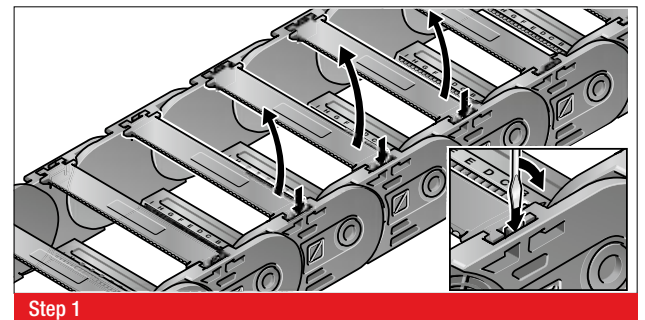
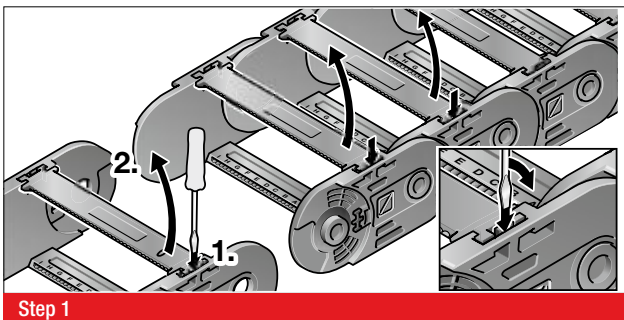

MP 65G

CLOSED



- PLASTIC VARIANT
- METAL CHAIN BRACKET
- OPENS ON INSIDE AND OUTSIDE OF BEND

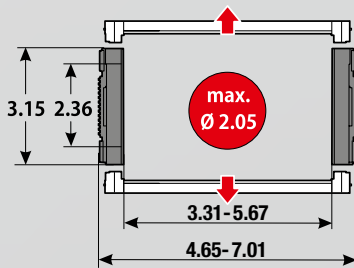

TECHNICAL DATA

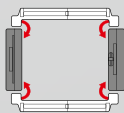

Loading side
Inside and outside bend

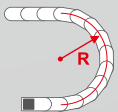

Available radii
7.87 – 15.75 inch

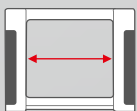

Available interior widths
with plastic cover
3.31 – 5.67 inch

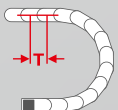

Grid
T = 3.60 inch

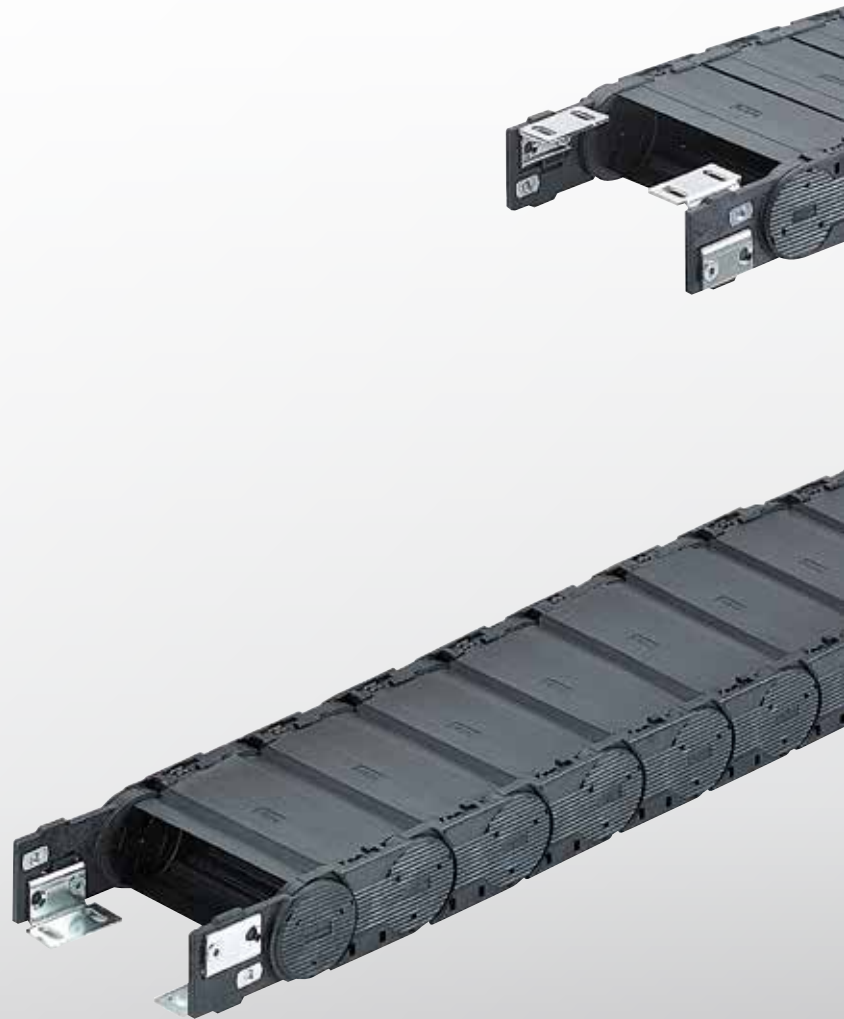



TECHNICAL SPECIFICATIONS

Travel distance gliding L_g max.	196.85 ft.
Travel distance self-supporting L_s max.	see diagram on page 157
Travel distance vertical, hanging L_{vh} max.	164.04 ft.
Travel distance vertical, upright L_{vs} max.	16.40 ft.
Rotated 90°, unsupported L_{90f} max.	6.56 ft.
Speed, gliding V_g max.	16.40 ft/s
Speed, self-supporting V_f max.	49.21 ft/s
Acceleration, gliding a_g max.	49.21 ft/s ²
Acceleration, self-supporting a_s max.	65.62 ft/s ²

Contact our engineering department to meet any higher requirements: efk@murrplastik.de

MATERIAL PROPERTIES

Standard material	Polyamide (PA) black
Service temperature	-22.00 – 248.00 °F
Gliding friction factor	0.30
Static friction factor	0.45
Fire classification	Based on UL 94 HB

Other material properties on request

CHAIN BRACKET

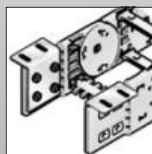

Chain bracket angle

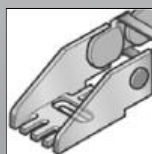

Chain bracket U-part

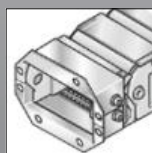

Chain bracket flange

SHELVING SYSTEM

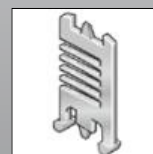

Separator TR



RS shelving system

GUIDE CHANNELS

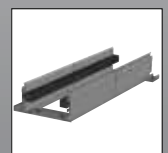

VAW aluminum

ORDERING KEY

Dimensions in mm [US inch]

Type code	Variation	Inside width	Outside width	Inside width	Outside width	Radius	Rail variant	Material	Chain length
0650 44	Cover on outside of bend Cover on inside of bend Opens on inside and outside of bend	084 [3.31]	118 [4.65]			200 [7.87]	0 Plastic, full-ridged with bias	0 Polyamide (PA): standard (PA/black)	
		105 [4.13]	139 [5.47]						
		144 [5.67]	178 [7.01]						
						240 [9.45]	1 Plastic, full-ridged without bias	9 Special version (on request)	
						280 [11.02]	9 Special version (on request)		
						350 [13.78]			
						400 [15.75]			

Ordering example: 0650 44 084 200 0 0 1556

Cover in outside bend, cover in inside bend, can be opened from inside and outside bend
 Inside width 3.31 in. (84 mm), radius 7.87 in. (200 mm)
 Plastic crossbar, full-ridged with bias, material black-colored polyamide
 Chain length 61.26 in. (1556 mm) (17 links)

SELF-SUPPORTING LENGTH

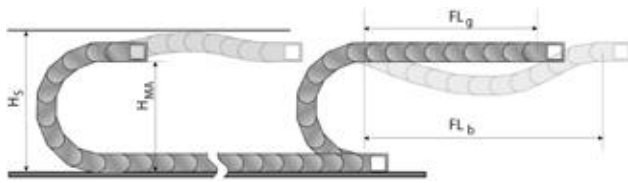

The self-supporting length is the distance between the chain bracket on the moving end and the start of the chain arch.
 The installation variant FL_g offers the lowest load and wear for the cable drag chain.
 The maximum travel parameters (speed and acceleration) can be applied for this variant.

- H_s = Installation height plus safety
- H_{MA} = Height of moving end connection
- FL_g = Self-supporting length, upper run straight
- FL_b = Self-supporting length, upper run bent

LOAD DIAGRAM FOR SELF-SUPPORTING APPLICATIONS

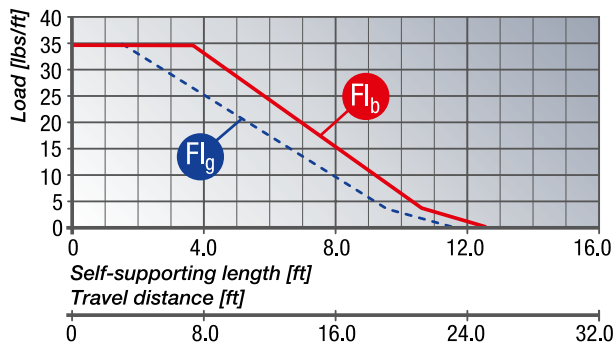

FL_g Self-supporting length, upper run straight
 In the FL_g range, the chain upper run still has a bias, is straight or has a maximum sag of 2.36 inch.

FL_b Self-supporting length, upper run bent
 In the FL_b range, the chain upper run has a sag of more than 2.36 inch, but this is still less than the maximum sag. Where the sag is greater than that permitted in the FL_b range, the application is critical and should be avoided. The self-supporting length can be optimized by using a support for the upper run or a more stable cable drag chain.

DETERMINING THE CHAIN LENGTH

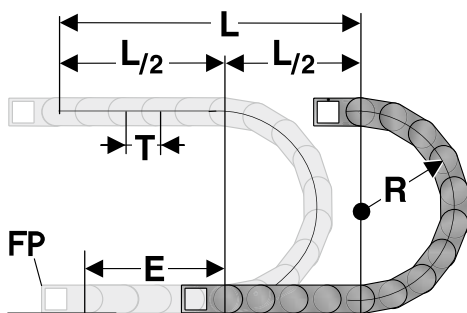

The fixed point of the cable drag chain should be connected in the middle of the travel distance.
 This arrangement gives the shortest connection between the fixed point (FP) and the moving bracket and thus the most efficient chain length.

Chain length calculation = $L/2 + \pi * R + E$
 $\approx 1 \text{ ft chain} = 4 \text{ qty.} \times 3.60 \text{ inch.}$

- E = Distance between entry point and middle of travel distance
- L = Travel distance
- R = Radius
- P = Grid 3.60 inch

INSTALLATION DIMENSIONS

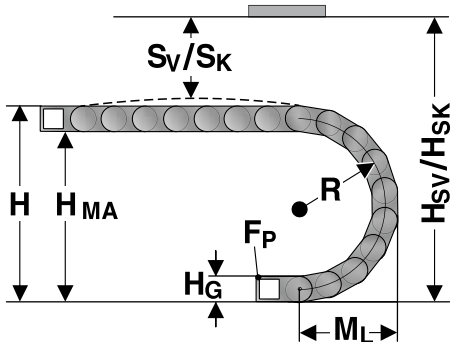

The moving end chain connection is to be screw fixed at height H_{MA} for the respective radius.

Concerning the installed dimensions, you must take into account whether the chain links are equipped with or without bias. For chain links without bias, the “Installed height without bias H_{SK} ” value has to be taken into account.

If the chain links are equipped with a bias, the value “Installed height with bias H_{SV} ” has to be taken into account.

Radius R	7.87	9.45	11.02	13.78	15.75
Outside height of chain link (H_G)	3.15	3.15	3.15	3.15	3.15
Height of bend (H)	18.89	22.05	25.19	30.71	34.65
Height of moving end connection (H_{MA})	15.74	18.90	22.04	27.56	31.50
Safety margin with bias (S_v)	1.97	1.97	1.97	1.97	1.97
Installation height with bias (H_{sv})	20.86	24.02	27.16	32.68	36.62
Safety margin without bias (S_k)	0.59	0.59	0.59	0.59	0.59
Installation height without bias (H_{sk})	19.48	22.64	25.78	31.30	35.24
Arc projection (M_L)	13.05	14.62	16.20	18.95	20.93

KA 66 CHAIN BRACKET ANGLE

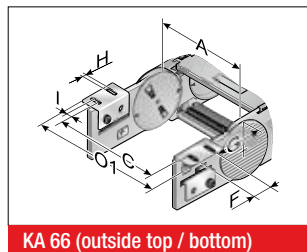
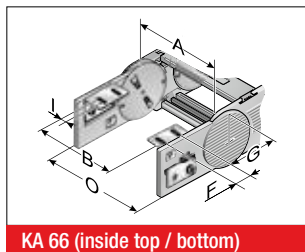

There are several options regarding the chain bracket. The fixed-point bracket (inside/bottom) and the moving end bracket (inside/top) are supplied as standard. However, any other combination can be supplied upon request. The chain bracket is fastened at the end like a side link. This enables the chain to move right up to the bracket. Each chain requires two chain brackets. The brackets should be fastened with M8 screws.

Type	Order No.	Material	Inside width							Outside width of KA 0	Outside width of KA 01	
			A inch	B inch	C inch	F inch	G inch	G1 inch	H0 inch			I inch
KA 66	0660000050	Sheet steel	2.44 – 7.17	A-0.67	A+2.01	1.77	1.99	3.39	0.35	0.39	A+1.34	A+2.52
KA 66	0660000060	Stainless steel 1.4301	2.44 – 7.17	A-0.67	A+2.01	1.77	1.99	3.39	0.35	0.39	A+1.34	A+2.52

KA 66 CHAIN BRACKET U-PART

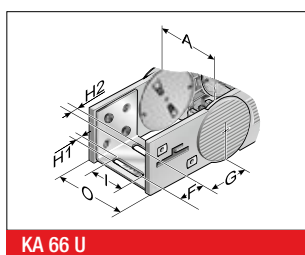

The chain bracket is an all-plastic part. The bracket is precisely adjusted to the respective chain width and only needs to be snapped in at the chain link. Please order one male and one female end bracket for each chain. The brackets should be fastened with M5 screws. The cables or conduits may be fastened with cable ties on the integrated strain relief of the chain bracket.

Type	Order No.	Material	Inside width					Outside width of KA 0	
			A inch	F inch	G inch	H1 inch	H2 inch		I inch
KA 66 U	0660000054	Sheet steel	1.77	1.10	2.30	0.26	0.33	1.30	A+1.34

KA 65 CHAIN BRACKET FLANGE

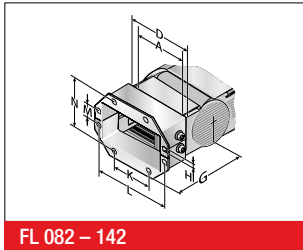

A cable drag chain requires two chain brackets. The divisible flange connection has been specifically designed for commissioning and re-installation. This keeps the chain in the installed position.

FL 082 – 142

Type	Order No.	Material	Inside width						
			A inch	G inch	HØ inch	K inch	L inch	M inch	N inch
FL 082	0650000070	Sheet steel	3.39	5.35	0.28	3.07	5.57	1.57	4.13
FL 107	0650000072	Sheet steel	4.02	5.35	0.28	3.94	6.44	1.57	4.13
FL 142	0650000074	Sheet steel	4.92	5.35	0.28	5.43	7.93	1.57	4.13
FL 082	0650000080	Stainless steel 1.4301	3.39	5.35	0.28	3.07	5.57	1.57	4.13
FL 107	0650000082	Stainless steel 1.4301	4.02	5.35	0.28	3.94	6.44	1.57	4.13
FL 142	0650000084	Stainless steel 1.4301	4.92	5.35	0.28	5.43	7.93	1.57	4.13

MP 66 SEPARATOR

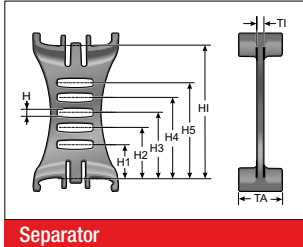

Separator

We recommend that separators be used if multiple round cables or conduits with differing diameters are to be installed.

Type	Order No.	Description	Version	TI inch	TA inch	H inch	H1 inch	H2 inch	H3 inch	H4 inch	H5 inch	H1 inch
TV 66	066000009000	Separator	lockable	0.14	0.79	0.17	0.62	0.90	1.18	1.46	1.74	2.36

MP 66 SHELVING SYSTEM

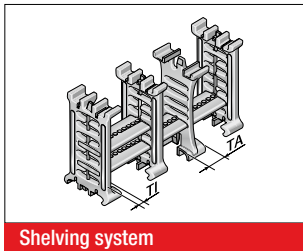

The shelf must be used with a minimum of two shelf supports to create a shelving system. The additional levels prevent cables from criss-crossing and minimize the friction between them. The shelving system may be preassembled on request.

Type	Order No.	Description	Width inch	Clearance width inch	Lock grid spacing inch	T1 inch	H1 inch	H2 inch	H3 inch	H4 inch	H5 inch	H6 inch	H7 inch
RB 031	100000003100	Shelf	1.65	1.22	0.06								
RB 048	100000004800	Shelf	2.32	1.89	0.06								
RB 070	100000007000	Shelf	3.19	2.76	0.06								
RB 092	100000009200	Shelf	4.06	3.62	0.06								
RB 100	100000010000	Shelf	4.37	3.94	0.06								
RB 128	100000012800	Shelf	5.47	5.04	0.06								
RB 167	100000016700	Shelf	7.01	6.57	0.06								
RT 66	1000900100	Shelf support	0.17		0.06	0.26	0.34	0.62	0.90	1.18	1.46	1.74	2.02

MP 66 REARWARD RADII

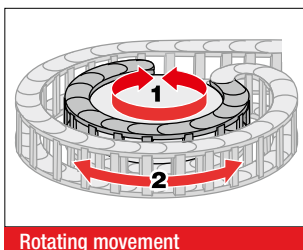

Side links with forward radius (R) and rearward radius (Rü) allow movements in both directions. This is intended for rotating movements and lowered chain brackets. Rotation movements are only possible with open variants.

Type	Order No.	Back radius inch	Version
SR 66 (RÜ240)	066000000060	9.45	Available for radii 5.91, 7.87, 9.45, 11.02 and 13.78 in

VAW GUIDE CHANNEL



A variable guide channel system, constructed from aluminum sections, is available for this cable drag chain. The variable guide channel ensures that the cable drag chain is supported and guided securely.

ASSEMBLY

DISASSEMBLY

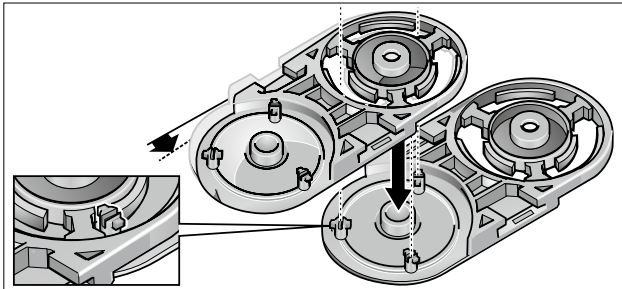

Step 1

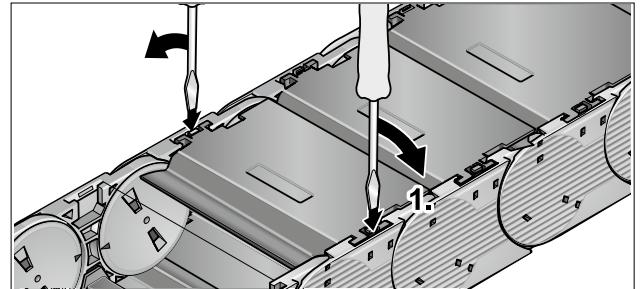

Step 1

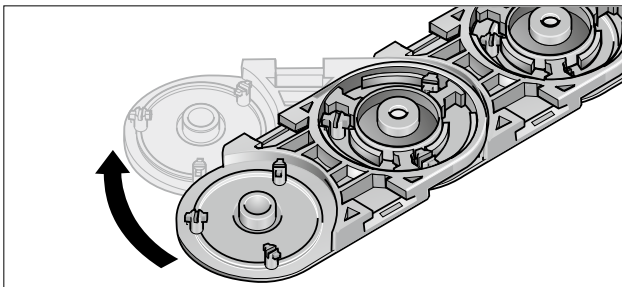

Step 2

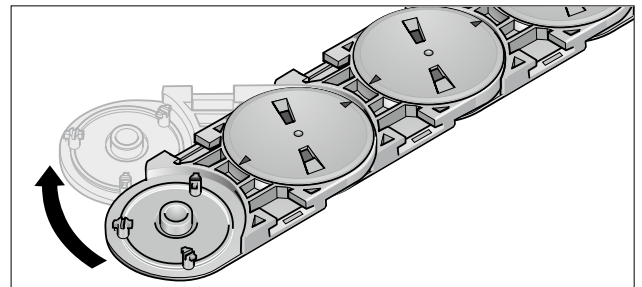

Step 2

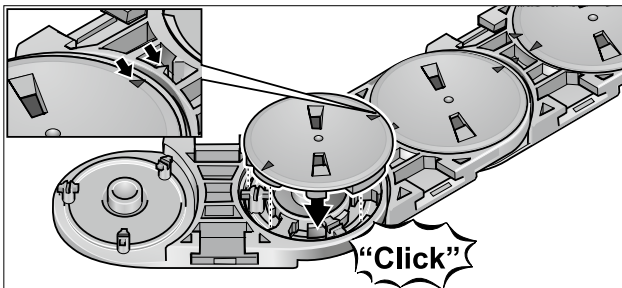

Step 3

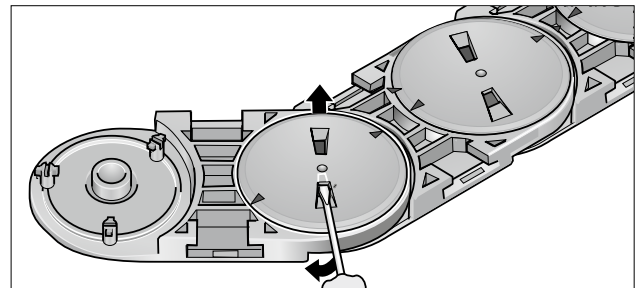

Step 3

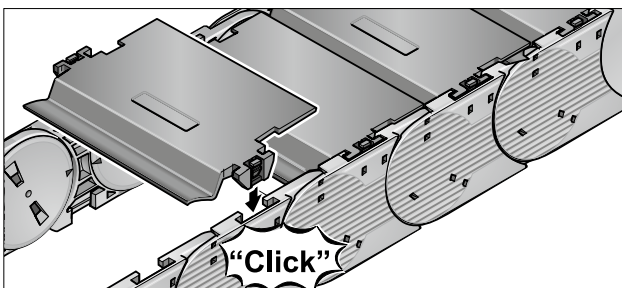

Step 4

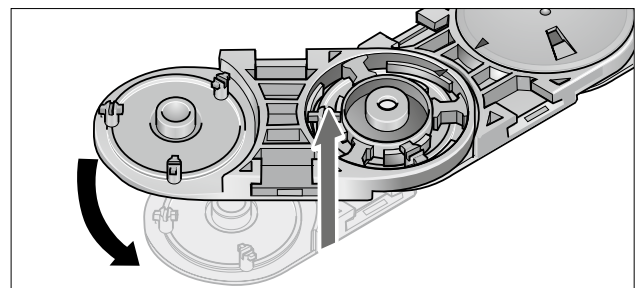

Step 4

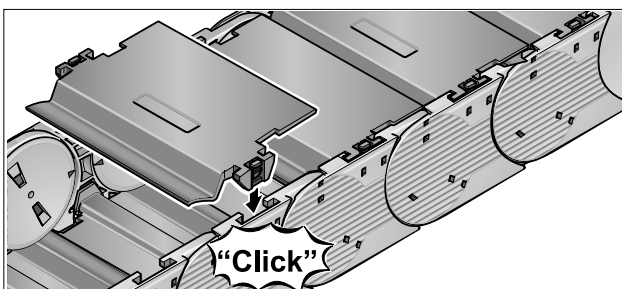

Step 5

MP 25.1/.2
OPEN



MP 25.3/.4
CLOSED



- BROAD INTERIOR LAYOUT
- BRUSH SUPPORT
- CHAIN BRACKET WITH INTEGRATED STRAIN RELIEF
- SUITABLE FOR UNIVERSAL USE

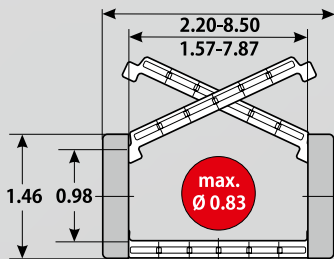

TECHNICAL DATA

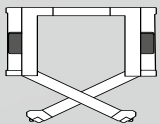

Loading side
Inside or outside bend

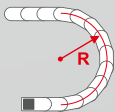

Available radii
1.97 – 11.81 inch

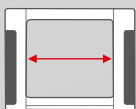

Available interior widths
With plastic crossbar
1.57 – 7.87 inch

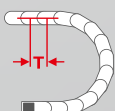

Grid
T = 1.77 inch

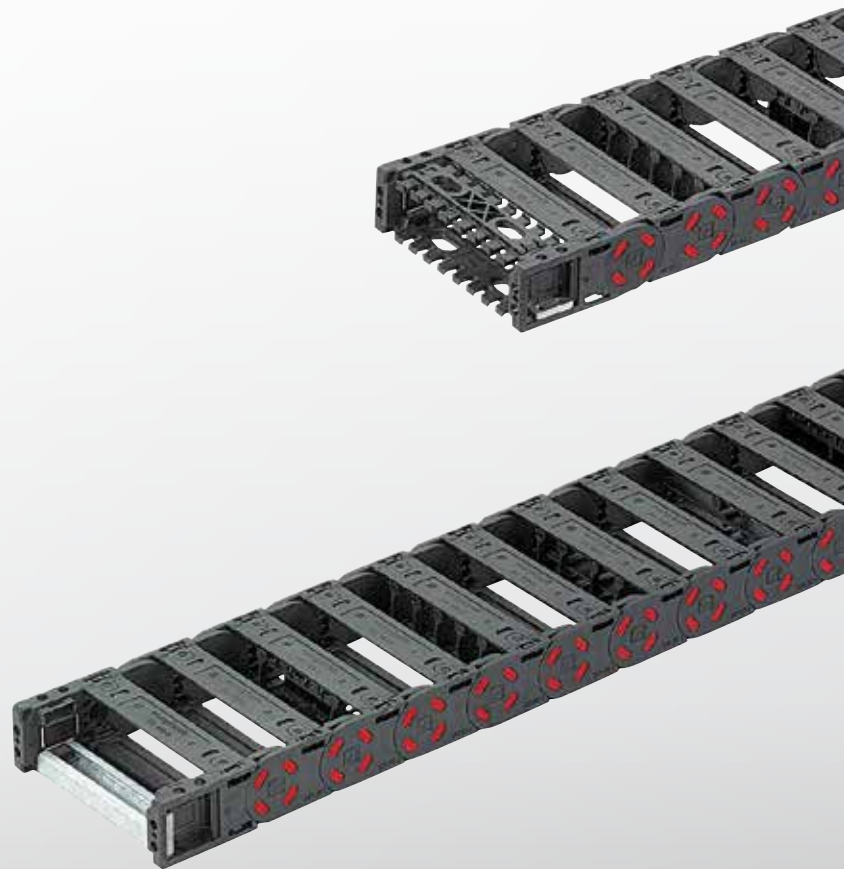

TECHNICAL SPECIFICATIONS

Travel distance gliding L_g max.	114.83 ft.
Travel distance self-supporting L_s max.	see diagram on page 165
Travel distance vertical, hanging L_{vh} max.	82.02 ft.
Travel distance vertical, upright L_{vs} max.	9.84 ft.
Rotated 90°, unsupported L_{90f} max.	2.30 ft.
Speed, gliding V_g max.	9.84 ft/s
Speed, self-supporting V_f max.	32.81 ft/s
Acceleration, gliding a_g max.	32.81 ft/s ²
Acceleration, self-supporting a_s max.	49.21 ft/s ²

Contact our engineering department to meet any higher requirements: efk@murrplastik.de

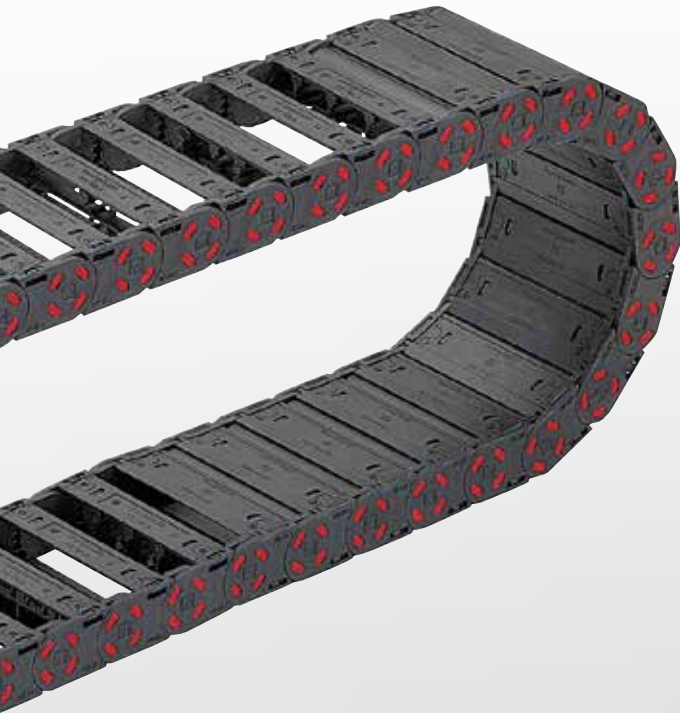

MATERIAL PROPERTIES

Standard material	Polyamide (PA) black
Service temperature	-22.00 – 248.00 °F
Gliding friction factor	0.30
Static friction factor	0.45
Fire classification	UL 94 HB

Other material properties on request

CHAIN BRACKET

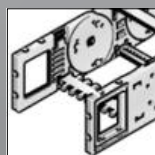

Chain bracket flexible

SHELVING SYSTEM

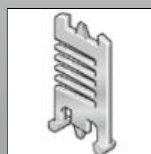

Separator TR

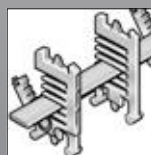

RS shelving system

GUIDE CHANNELS



VAW steel galvanized / stainless steel

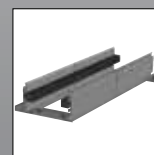

VAW aluminum

STRAIN RELIEF

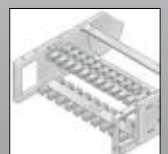

RS-ZL crossbar strain relief



STF Steel Fix

ORDERING KEY

Dimensions in mm [US inch]

Type code	Variation	Inside width	Outside width	Inside width	Outside width	Radius	Rail variant	Material	Chain length																																																																																
0025 01	Crossbar on outside bend Crossbar on inside bend Opens on outside bend	040 [1.57]	056 [2.20]			050 ¹⁾ [1.97]	0 Plastic, full-ridged with bias	0 Polyamide (PA): standard (PA/black)																																																																																	
		050 [1.97]	066 [2.60]							0025 02	Crossbar on outside bend Crossbar on inside bend Opens on inside of bend	060 [2.36]	076 [2.99]			075 ¹⁾ [2.95]	1 Plastic, full-ridged without bias	7 ESD (PA/light gray)		075 [2.95]	091 [3.58]			0025 03	Cover on outside of bend Cover on inside of bend Opens on outside bend	085 [3.35]	101 [3.98]			100 [3.94]		9 Special version (on request)		100 [3.94]	116 [4.57]			0025 04	Cover on outside of bend Cover on inside of bend Opens on inside of bend	125 [4.92]	141 [5.55]			125 [4.92]				150 [5.91]	166 [6.54]			0025 05	Cover on outside of bend Crossbar on inside bend Opens on outside bend	200 [7.87]	216 [8.50]			150 [5.91]								0025 06	Cover on outside of bend Crossbar on inside bend Opens on inside of bend					200 [7.87]				0025 07	Crossbar on outside bend Cover on inside of bend Opens on outside bend					250 [9.84]				0025 08	Crossbar on outside bend Cover on inside of bend Opens on inside of bend		
0025 02	Crossbar on outside bend Crossbar on inside bend Opens on inside of bend	060 [2.36]	076 [2.99]			075 ¹⁾ [2.95]	1 Plastic, full-ridged without bias	7 ESD (PA/light gray)																																																																																	
		075 [2.95]	091 [3.58]							0025 03	Cover on outside of bend Cover on inside of bend Opens on outside bend	085 [3.35]	101 [3.98]			100 [3.94]		9 Special version (on request)		100 [3.94]	116 [4.57]			0025 04	Cover on outside of bend Cover on inside of bend Opens on inside of bend	125 [4.92]	141 [5.55]			125 [4.92]				150 [5.91]	166 [6.54]			0025 05	Cover on outside of bend Crossbar on inside bend Opens on outside bend	200 [7.87]	216 [8.50]			150 [5.91]								0025 06	Cover on outside of bend Crossbar on inside bend Opens on inside of bend					200 [7.87]				0025 07	Crossbar on outside bend Cover on inside of bend Opens on outside bend					250 [9.84]				0025 08	Crossbar on outside bend Cover on inside of bend Opens on inside of bend					300 [11.81]											
0025 03	Cover on outside of bend Cover on inside of bend Opens on outside bend	085 [3.35]	101 [3.98]			100 [3.94]		9 Special version (on request)																																																																																	
		100 [3.94]	116 [4.57]							0025 04	Cover on outside of bend Cover on inside of bend Opens on inside of bend	125 [4.92]	141 [5.55]			125 [4.92]				150 [5.91]	166 [6.54]			0025 05	Cover on outside of bend Crossbar on inside bend Opens on outside bend	200 [7.87]	216 [8.50]			150 [5.91]								0025 06	Cover on outside of bend Crossbar on inside bend Opens on inside of bend					200 [7.87]				0025 07	Crossbar on outside bend Cover on inside of bend Opens on outside bend					250 [9.84]				0025 08	Crossbar on outside bend Cover on inside of bend Opens on inside of bend					300 [11.81]																									
0025 04	Cover on outside of bend Cover on inside of bend Opens on inside of bend	125 [4.92]	141 [5.55]			125 [4.92]																																																																																			
		150 [5.91]	166 [6.54]							0025 05	Cover on outside of bend Crossbar on inside bend Opens on outside bend	200 [7.87]	216 [8.50]			150 [5.91]								0025 06	Cover on outside of bend Crossbar on inside bend Opens on inside of bend					200 [7.87]				0025 07	Crossbar on outside bend Cover on inside of bend Opens on outside bend					250 [9.84]				0025 08	Crossbar on outside bend Cover on inside of bend Opens on inside of bend					300 [11.81]																																							
0025 05	Cover on outside of bend Crossbar on inside bend Opens on outside bend	200 [7.87]	216 [8.50]			150 [5.91]																																																																																			
										0025 06	Cover on outside of bend Crossbar on inside bend Opens on inside of bend					200 [7.87]				0025 07	Crossbar on outside bend Cover on inside of bend Opens on outside bend					250 [9.84]				0025 08	Crossbar on outside bend Cover on inside of bend Opens on inside of bend					300 [11.81]																																																					
0025 06	Cover on outside of bend Crossbar on inside bend Opens on inside of bend					200 [7.87]																																																																																			
0025 07	Crossbar on outside bend Cover on inside of bend Opens on outside bend					250 [9.84]																																																																																			
0025 08	Crossbar on outside bend Cover on inside of bend Opens on inside of bend					300 [11.81]																																																																																			

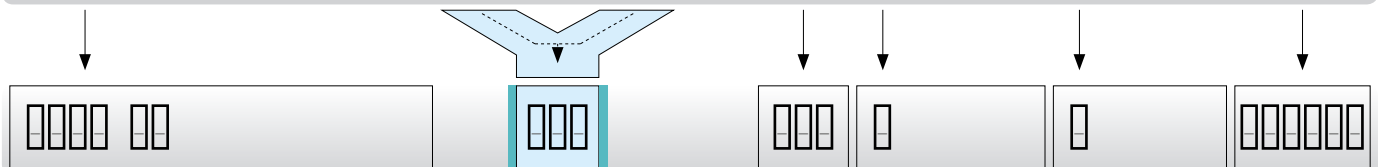

ORDERING EXAMPLE: 0025 01 040 050 0 0 1125

Crossbar on outside bend, crossbar on inside bend, can be opened from outside bend
 Inside width 1.57 in. (40 mm); radius 1.97 in. (50 mm)
 Plastic crossbar, full-ridged with bias, material black-colored polyamide
 Chain length 1125 mm (25 links)

¹⁾ only for Version 01 and 02

SELF-SUPPORTING LENGTH

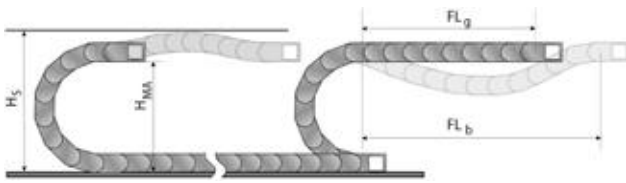

The self-supporting length is the distance between the chain bracket on the moving end and the start of the chain arch.
 The installation variant FL_g offers the lowest load and wear for the cable drag chain.
 The maximum travel parameters (speed and acceleration) can be applied for this variant.

- H_s = Installation height plus safety
- H_{MA} = Height of moving end connection
- FL_g = Self-supporting length, upper run straight
- FL_b = Self-supporting length, upper run bent

LOAD DIAGRAM FOR SELF-SUPPORTING APPLICATIONS

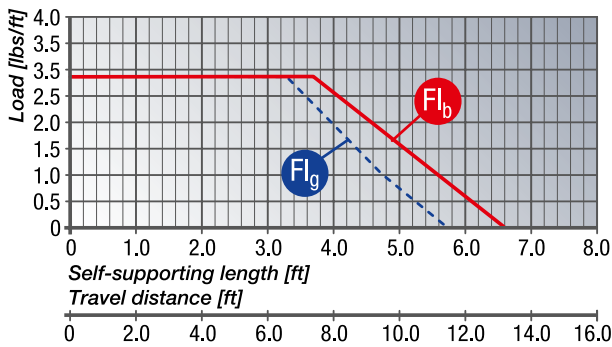

FL_g Self-supporting length, upper run straight

In the FL_g range, the chain upper run still has a bias, is straight or has a maximum sag of 2.36 inch.

FL_b Self-supporting length, upper run bent

In the FL_b range, the chain upper run has a sag of more than 2.36 inch, but this is still less than the maximum sag. Where the sag is greater than that permitted in the FL_b range, the application is critical and should be avoided. The self-supporting length can be optimized by using a support for the upper run or a more stable cable drag chain.

Closed cable drag chains (with covers) have a higher unit weight than open chains (with crossbars). This higher weight must be taken into account when calculating the self-supporting length. To the weight of the cabling (cable load, in kg/m), you must add 0.3 kg/m, to account for the higher weight of closed-cover chains.

DETERMINING THE CHAIN LENGTH

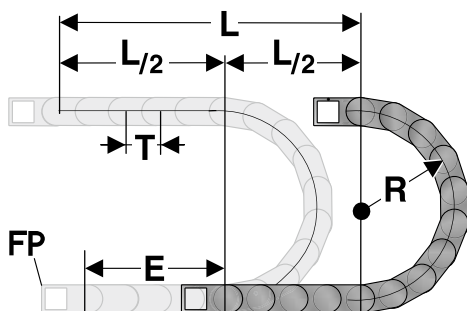

The fixed point of the cable drag chain should be connected in the middle of the travel distance.
 This arrangement gives the shortest connection between the fixed point (FP) and the moving bracket and thus the most efficient chain length.

Chain length calculation = $L/2 + \pi * R + E$
 $\approx 1 \text{ ft chain} = 7 \text{ qty.} \times 1.77 \text{ inch.}$

- E = Distance between entry point and middle of travel distance
- L = Travel distance
- R = Radius
- P = Grid 1.77 inch

INSTALLATION DIMENSIONS

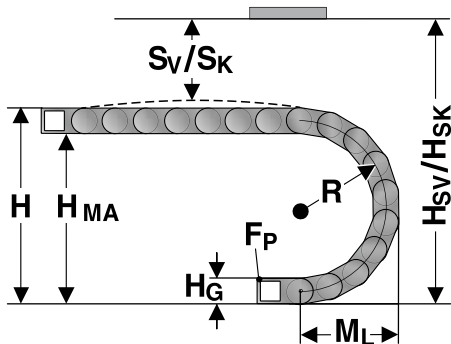

The moving end chain connection is to be screw fixed at height H_{MA} for the respective radius.

Concerning the installed dimensions, you must take into account whether the chain links are equipped with or without bias. For chain links without bias, the “Installed height without bias H_{SK} ” value has to be taken into account.

If the chain links are equipped with a bias, the value “Installed height with bias H_{SV} ” has to be taken into account.

Radius R	1.97	2.95	3.94	4.92	5.91	7.87	9.84	11.81
Outside height of chain link (H_G)	1.46	1.46	1.46	1.46	1.46	1.46	1.46	1.46
Height of bend (H)	6.18	8.14	10.12	12.08	14.06	17.98	21.92	25.86
Height of moving end connection (H_{MA})	4.72	6.68	8.66	10.62	12.60	16.52	20.46	24.40
Safety margin with bias (S_V)	1.50	1.50	1.50	1.50	1.50	1.50	1.50	1.50
Installation height with bias (H_{SV})	7.68	9.64	11.62	13.58	15.56	19.48	23.42	27.36
Safety margin without bias (S_K)	0.71	0.71	0.71	0.71	0.71	0.71	0.71	0.71
Installation height without bias (H_{SK})	6.89	8.85	10.83	12.79	14.77	18.69	22.63	26.57
Arc projection (M_L)	4.86	5.84	6.83	7.81	8.80	10.76	12.73	14.70

EB 25/30 INSERT PANEL

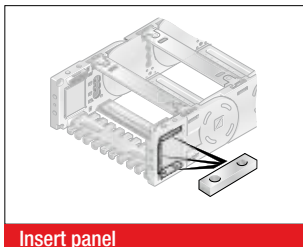

To fix the chain connection, the insert panels can be inserted above, below or on the side and are available with threads or through-holes.

Type	Order No.	Description	Holes inch	Thread
EB 25/30-FG V2A	030100005502	Insert panel with thread		M5x0,8
EB 25/30-FB V2A	030100005500	Insert panel with through-hole	0.22	

KA 25 CHAIN BRACKET FLEXIBLE

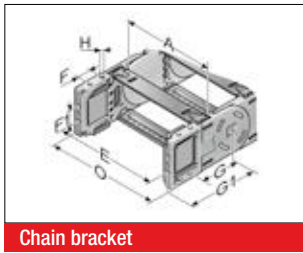

This chain bracket offers universal connection options (top, bottom and front) and is attached to the ends of the chain like a side link. This allows the chain to move right up to the bracket. Each chain requires one male and one female bracket. M5 screws and insert panels are used to secure the brackets in place.
 By default, the chain bracket is supplied with crossbars.
 The chain bracket can then be optionally fitted with crossbar strain relief plates (RS-ZL) or with strain relief using C-rails and type STF bow clamps.

Type	Order No.	Material	Inside width								Outside width of KA 0 inch
			A inch	E inch	F inch	F1 inch	G inch	G1 inch	H	H0 inch	
KA25	KA25ML	Plastic	1.57 – 7.87	A+0.35	0.47	0.47	1.67	2.76	M5	0.22	A+0.71

Configurator chain bracketKA25

Configurator for chain brackets:

Type KA	Inside width	Radius	RS-ZL No.	C-Profile No.	No. of EB**
	inch/mm	inch/mm	pieces	pieces	pieces
KA 25*	3.35/085	9.84/250	2	0	2

Ordering example:

- Type = KA 25 = Chain bracket flexible for MP 25
- Internal width = 3.35 in. (085 mm)
- Radius = 9.84 in. (250 mm)
- Crossbar-strain relief (RS-ZL) = 2 pieces
- C-rail = 0 pieces
- Insert panel (EB) = 2 pieces

* One set of chain brackets is needed per chain, containing female and male end
 ** Two insert panels (EB) are needed per connection element

Note:

For an exact determination of the chain bracket, the inside width and radius are absolutely essential. Optionally, crossbar strain relief plates (RS-ZL), C-sections and insert panels (EB) can be chosen.

MP 25 SEPARATOR / SHELF SUPPORT

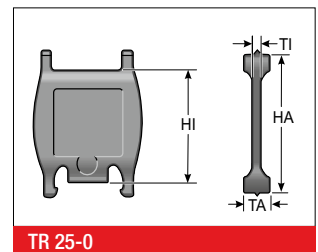
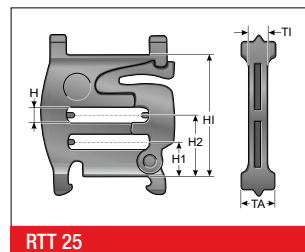
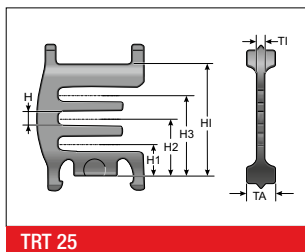
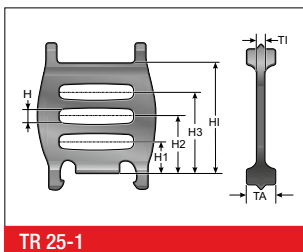

We recommend that separators be used if multiple round cables

or conduits with differing diameters are to be installed.

Type	Order No.	Description	Version	TI inch	TA inch	H inch	H1 inch	H2 inch	H3 inch	HI inch
TR 25-0	025100009300	Separator, closed	lockable	0.09	0.31					0.98
TR 25-1	025100009400	Separator, open	lockable	0.09	0.31	0.13	0.28	0.49	0.71	0.98
TRT 25	025100009200	Separator, divisible	lockable	0.09	0.31	0.13	0.28	0.49	0.71	0.98
RTT 25	025100006500	Shelf support, divisible	lockable	0.18	0.31	0.13	0.28	0.49		0.98

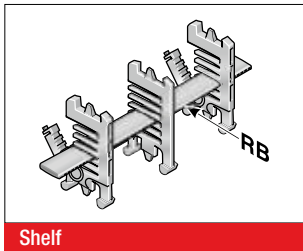
RB-3 SHELF

In connection with at least two separable shelf supports (RTT), the shelf becomes a shelving system. The additional levels prevent cables from criss-crossing and minimize the friction between them.

Type	Order No.	Description	Width inch	Inside width inch
RB 039-3	030100003900	Shelf	1.52	1.57
RB 041-3	1000004103	Shelf	1.62	1.97
RB 044-3	1000004403	Shelf	1.72	1.97
RB 046-3	1000004603	Shelf	1.81	1.97
RB 049-3	030100004900	Shelf	1.91	1.97
RB 051-3	1000005103	Shelf	2.01	2.36
RB 054-3	1000005403	Shelf	2.11	2.36
RB 056-3	1000005603	Shelf	2.21	2.36
RB 059-3	030100005900	Shelf	2.31	2.36
RB 061-3	1000006103	Shelf	2.41	2.95
RB 064-3	1000006403	Shelf	2.50	2.95
RB 066-3	1000006603	Shelf	2.60	2.95
RB 069-3	1000006903	Shelf	2.70	2.95
RB 071-3	1000007103	Shelf	2.80	2.95
RB 074-3	030100007400	Shelf	2.90	2.95
RB 076-3	1000007603	Shelf	3.00	3.35
RB 079-3	1000007903	Shelf	3.09	3.35
RB 081-3	1000008103	Shelf	3.19	3.35
RB 084-3	030100008400	Shelf	3.29	3.35
RB 086-3	1000008603	Shelf	3.39	3.94
RB 089-3	1000008903	Shelf	3.49	3.94
RB 091-3	1000009103	Shelf	3.59	3.94
RB 094-3	1000009403	Shelf	3.69	3.94
RB 096-3	1000009603	Shelf	3.78	3.94
RB 099-3	030100009900	Shelf	3.88	3.94
RB 101-3	1000010103	Shelf	3.98	4.53
RB 104-3	1000010403	Shelf	4.08	4.53
RB 106-3	1000010603	Shelf	4.18	4.53
RB 109-3	1000010903	Shelf	4.28	4.53
RB 111-3	1000011103	Shelf	4.37	4.53
RB 114-3	030100011400	Shelf	4.47	4.53
RB 116-3	1000011603	Shelf	4.57	4.92
RB 119-3	1000011903	Shelf	4.67	4.92
RB 121-3	1000012103	Shelf	4.77	4.92
RB 124-3	030100012400	Shelf	4.87	4.92
RB 126-3	1000012603	Shelf	4.96	5.91
RB 129-3	1000012903	Shelf	5.06	5.91
RB 131-3	1000013103	Shelf	5.16	5.91
RB 134-3	1000013403	Shelf	5.26	5.91

RB-3 SHELF

Type	Order No.	Description	Width inch	Inside width inch
RB 136-3	1000013603	Shelf	5.36	5.91
RB 139-3	1000013903	Shelf	5.46	5.91
RB 141-3	1000014103	Shelf	5.56	5.91
RB 144-3	1000014403	Shelf	5.65	5.91
RB 146-3	1000014603	Shelf	5.75	5.91
RB 149-3	030100014900	Shelf	5.85	5.91
RB 151-3	1000015103	Shelf	5.95	6.89
RB 154-3	1000015403	Shelf	6.05	6.89
RB 156-3	1000015603	Shelf	6.15	6.89
RB 159-3	1000015903	Shelf	6.24	6.89
RB 161-3	1000016103	Shelf	6.34	6.89
RB 164-3	1000016403	Shelf	6.44	6.89
RB 166-3	1000016603	Shelf	6.54	6.89
RB 169-3	1000016903	Shelf	6.64	6.89
RB 174-3	030100017400	Shelf	6.83	6.89
RB 176-3	1000017603	Shelf	6.93	7.87
RB 179-3	1000017903	Shelf	7.03	7.87
RB 181-3	1000018103	Shelf	7.13	7.87
RB 184-3	1000018403	Shelf	7.23	7.87
RB 186-3	1000018603	Shelf	7.33	7.87
RB 189-3	1000018903	Shelf	7.43	7.87
RB 191-3	1000019103	Shelf	7.52	7.87
RB 194-3	1000019403	Shelf	7.62	7.87
RB 196-3	1000019603	Shelf	7.72	7.87
RB 199-3	030100019900	Shelf	7.82	7.87

W



The shelf RBD creates a horizontal separation over the entire width of the chain link. When used together with the TRT 30 separator, an additional, vertical division can be realized.

Type	Order No.	Description	Width inch	Inside width inch
RBD 040-3	030100004001	Shelf, end-to-end	1.57	1.57
RBD 050-3	030100005001	Shelf, end-to-end	1.97	1.97
RBD 060-3	030100006001	Shelf, end-to-end	2.36	2.36
RBD 075-3	030100007501	Shelf, end-to-end	2.95	2.95
RBD 085-3	030100008501	Shelf, end-to-end	3.35	3.35
RBD 100-3	030100010001	Shelf, end-to-end	3.94	3.94

MP 25 BRUSH SUPPORT

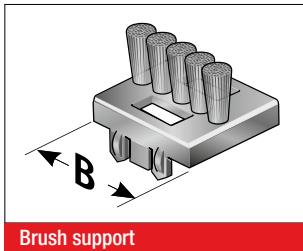

Brush support

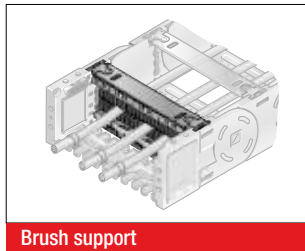

Brush support

The cables in the neutral strand are routed through the brush supports. This innovative solution was developed especially for applications where cables are subjected to higher levels of wear from cyclical movement.

Type	Order No.	Description	Version	Width inch
BT 20-25, completely	025100009702	Brush support	lockable	0.79
BT 25-25, completely	025100009802	Brush support	lockable	0.98

RS-ZL-3 CROSSBAR STRAIN RELIEF PLATE

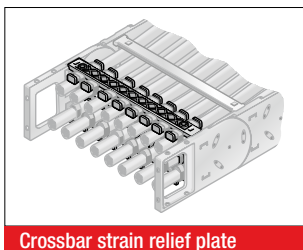

Crossbar strain relief plate

Fixed integrated crossbar strain relief plates in the chain brackets. Tailored to all crossbar widths up to 7.87 inch. May be assembled on the inside and outside bends at both chain endings.

Type	Order No.	Description	Inside width inch
RS-ZL 040-3	030104000010	Crossbar strain relief plate	1.57
RS-ZL 050-3	030105000010	Crossbar strain relief plate	1.97
RS-ZL 060-3	030106000010	Crossbar strain relief plate	2.36
RS-ZL 075-3	030107500010	Crossbar strain relief plate	2.95
RS-ZL 085-3	030108500010	Crossbar strain relief plate	3.35
RS-ZL 100-3	030110000010	Crossbar strain relief plate	3.94
RS-ZL 125-3	030112500010	Crossbar strain relief plate	4.92
RS-ZL 150-3	030115000010	Crossbar strain relief plate	5.91
RS-ZL 200-3	030120000010	Crossbar strain relief plate	7.87

STRAIN RELIEF WITH STEEL FIX

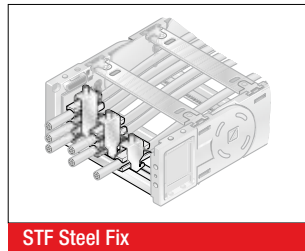
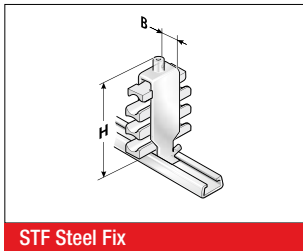

C-rails (galvanized) for permanent integration, for accommodating the Steel Fix bow clamps in the chain brackets. The bow clamps can take up to 3 cables and are suitable for C-rails with a groove width of 0.43 in (11 mm). Due to the design of the trough elements, a cable preserving cable guidance is ensured. May be assembled on the inside and outside bends at both chain endings. The overall height stated is a guide only. The actual height is, amongst other things, dependent on the diameter and the quality of the cable. A safety distance of 0.39 in (10 mm) at the fixed point above the strain relief must be kept during gliding applications.

Type	Order No.	Description	Seats qty.	Cable Ø inch	Width (B) inch	Total height (H) inch
Single clamp (for one cable)						
STF 12-1 Steel Fix	81661801	Hooped clamp	1	0.24 – 0.47	0.63	2.17
STF 14-1 Steel Fix	81661802	Hooped clamp	1	0.47 – 0.55	0.71	2.05
STF 16-1 Steel Fix	81661803	Hooped clamp	1	0.55 – 0.63	0.79	2.13
STF 18-1 Steel Fix	81661804	Hooped clamp	1	0.63 – 0.71	0.87	2.20
STF 20-1 Steel Fix	81661805	Hooped clamp	1	0.71 – 0.79	0.94	2.32
STF 22-1 Steel Fix	81661806	Hooped clamp	1	0.79 – 0.87	1.02	2.40
STF 26-1 Steel Fix	81661807	Hooped clamp	1	0.87 – 1.02	1.18	2.76
STF 30-1 Steel Fix	81661808	Hooped clamp	1	1.02 – 1.18	1.34	2.91
STF 34-1 Steel Fix	81661809	Hooped clamp	1	1.18 – 1.34	1.50	3.07
STF 38-1 Steel Fix	81661810	Hooped clamp	1	1.34 – 1.50	1.65	3.23
STF 42-1 Steel Fix	81661811	Hooped clamp	1	1.50 – 1.65	1.81	3.58
Double clamp (for two cables)						
STF 12-2 Steel Fix	81661821	Hooped clamp	2	0.24 – 0.47	0.63	2.87
STF 14-2 Steel Fix	81661822	Hooped clamp	2	0.47 – 0.55	0.71	2.91
STF 16-2 Steel Fix	81661823	Hooped clamp	2	0.55 – 0.63	0.79	3.23
STF 18-2 Steel Fix	81661824	Hooped clamp	2	0.63 – 0.71	0.87	3.39
STF 20-2 Steel Fix	81661825	Hooped clamp	2	0.71 – 0.79	0.94	3.58
STF 22-2 Steel Fix	81661826	Hooped clamp	2	0.79 – 0.87	1.02	3.74
STF 26-2 Steel Fix	81661827	Hooped clamp	2	0.87 – 1.02	1.18	4.25
STF 30-2 Steel Fix	81661828	Hooped clamp	2	1.02 – 1.18	1.34	4.76
STF 34-2 Steel Fix	81661829	Hooped clamp	2	1.18 – 1.34	1.50	5.08
Triple clamp (for three cables)						
STF 12-3 Steel Fix	81661841	Hooped clamp	3	0.24 – 0.47	0.63	3.86
STF 14-3 Steel Fix	81661842	Hooped clamp	3	0.47 – 0.55	0.71	3.86
STF 16-3 Steel Fix	81661843	Hooped clamp	3	0.55 – 0.63	0.79	4.13
STF 18-3 Steel Fix	81661844	Hooped clamp	3	0.63 – 0.71	0.87	4.37
STF 20-3 Steel Fix	81661845	Hooped clamp	3	0.71 – 0.79	0.94	4.65
STF 22-3 Steel Fix	81661846	Hooped clamp	3	0.79 – 0.87	1.02	5.12

MP 25 LOWERED FIXING POINT

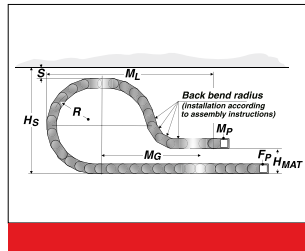
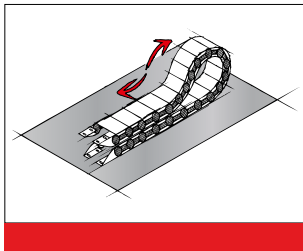

It is sometimes necessary to lower the height of the moving attachment point. In such cases, modifications to the chain layout should be noted (e.g. extension of chain). Please contact our application engineers.

Radius R inch	Height of moving end connection (H _{MA}) inch	Safety margin (S) inch	Installation height incl. safety (H _I) inch	Projection (M _L) inch	Additional links qty.	of which additional back chain links qty.
3.94	3.94	1.97	11.30	11.42	5	3
4.92	3.94	1.97	13.27	13.39	6	3
5.91	3.94	1.97	15.24	17.72	8	5
7.87	3.94	1.97	19.17	23.23	11	6
9.84	3.94	1.97	23.11	27.95	14	7
11.81	3.94	1.97	27.05	31.89	17	8

MP 25.1/2 REARWARD RADII

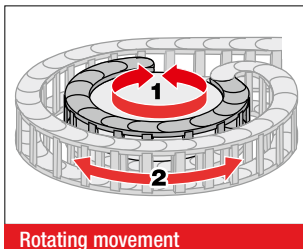

Rotating movement

Side links with forward radius (R) and rearward radius (R_ü) allow movements in both directions. This is intended for rotating movements and lowered chain brackets. The appropriate number of washer discs have to be placed into the side links to achieve the rearward radius.

Type	Order No.
AS 25 (RÜ075/R075) left	025100007560
AS 25 RÜ075/R075 right	025100007562
AS 25 (RÜ100/R100) left	025100010060
AS 25 RÜ100/R100 right	025100010062

GUIDE CHANNEL VAW (ALUMINUM / STAINLESS STEEL)



VAW steel galvanized / stainless steel



VAW aluminum

A range of variable guide channel systems, constructed from aluminum or stainless steel sections, is available for this cable drag chain. The variable guide channel ensures that the cable drag chain is supported and guided securely.

ASSEMBLY

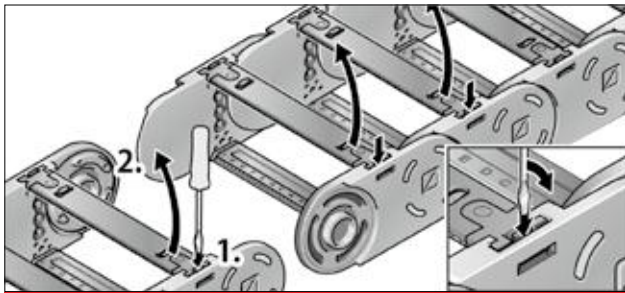

Step 1

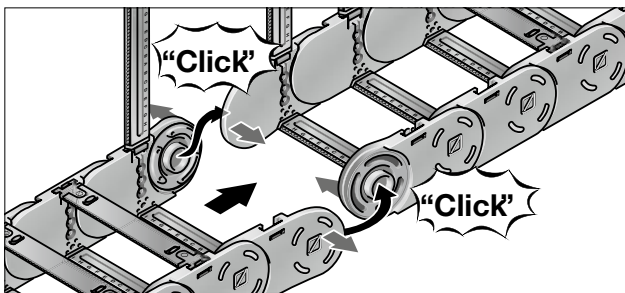

Step 2

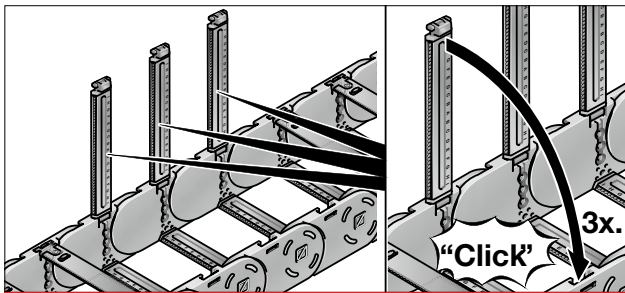

Step 3

DISASSEMBLY

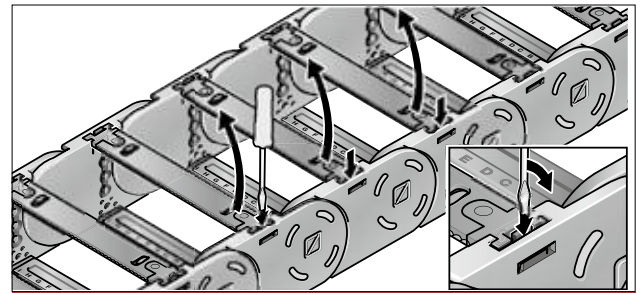

Step 1

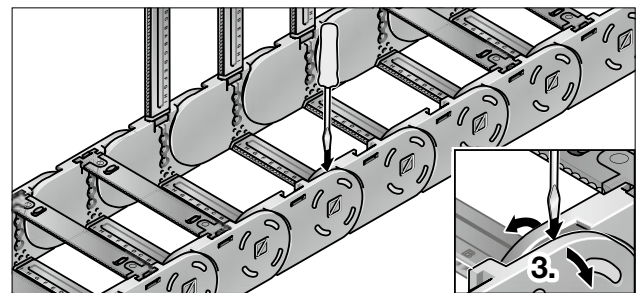

Step 2

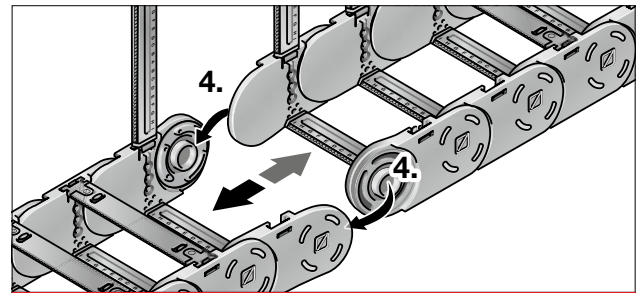

Step 3

MP 30.1/.2
OPEN



MP 30.3/.4
CLOSED

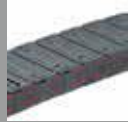

- BROAD INTERIOR LAYOUT
- BRUSH SUPPORT
- CHAIN BRACKET WITH INTEGRATED STRAIN RELIEF
- SUITABLE FOR UNIVERSAL USE

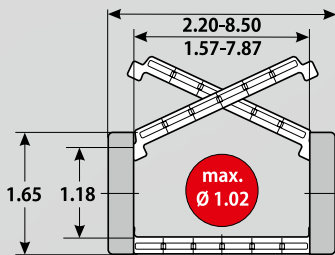

TECHNICAL DATA

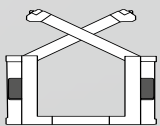

Loading side
Inside or outside bend

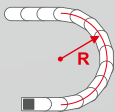

Available radii
2.36 – 11.81 inch

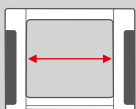

Available interior widths
With plastic crossbar
1.57 – 7.87 inch

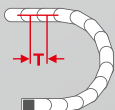

Grid
T = 1.97 inch

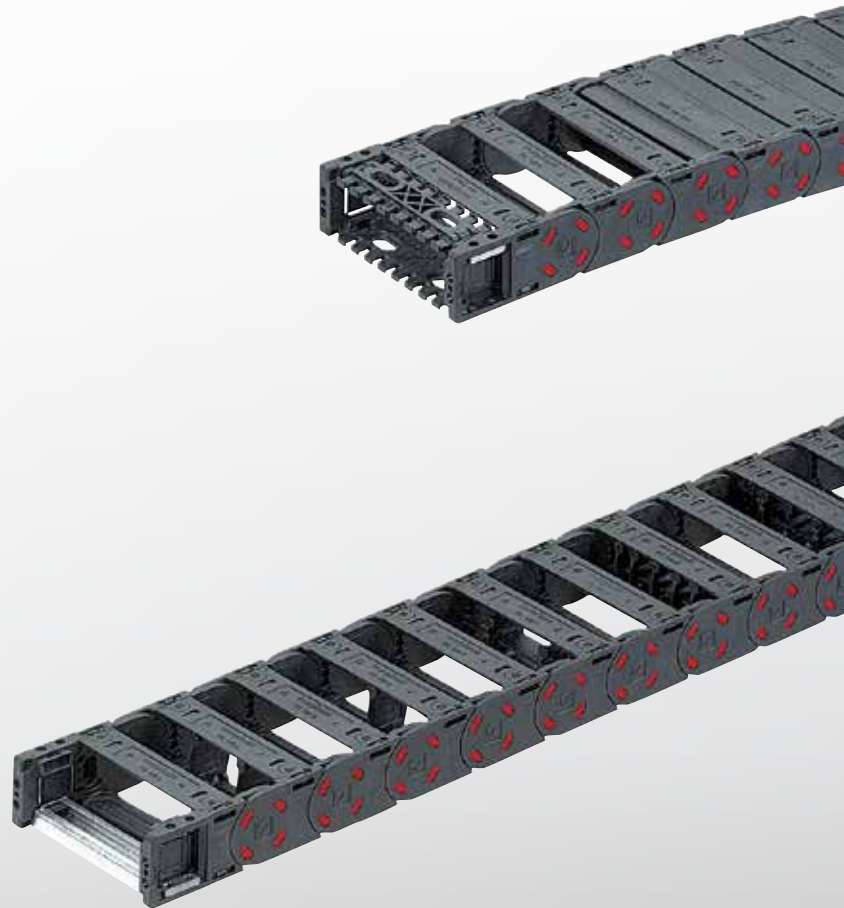

TECHNICAL SPECIFICATIONS

Travel distance gliding L_g max.	131.23 ft.
Travel distance self-supporting L_s max.	see diagram on page 177
Travel distance vertical, hanging L_{vh} max.	98.43 ft.
Travel distance vertical, upright L_{vs} max.	9.84 ft.
Rotated 90°, unsupported L_{90f} max.	2.30 ft.
Speed, gliding V_g max.	9.84 ft/s
Speed, self-supporting V_f max.	32.81 ft/s
Acceleration, gliding a_g max.	32.81 ft/s ²
Acceleration, self-supporting a_s max.	49.21 ft/s ²

Contact our engineering department to meet any higher requirements: efk@murrplastik.de



MATERIAL PROPERTIES

Standard material	Polyamide (PA) black
Service temperature	-22.00 – 248.00 °F
Gliding friction factor	0.30
Static friction factor	0.45
Fire classification	UL 94 HB

Other material properties on request

SHELVING SYSTEM



Separator TR

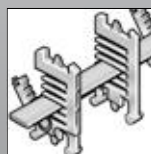

RS shelving system

CHAIN BRACKET

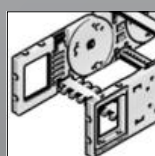

Chain bracket flexible

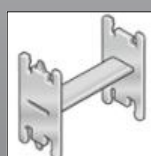

H-shaped shelf unit RE

GUIDE CHANNELS



VAW steel galvanized / stainless steel

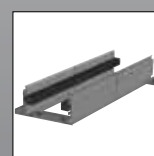

VAW aluminum

STRAIN RELIEF

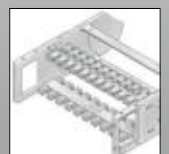

RS-ZL crossbar strain relief



STF Steel Fix

ORDERING KEY

Dimensions in mm [US inch]

Type code	Variation	Inside width	Outside width	Inside width	Outside width	Radius	Rail variant	Material	Chain length
0030 01	Crossbar on outside bend Crossbar on inside bend Opens on outside bend	040 [1.57]	056 [2.20]			060 ¹⁾ [2.36]	0 Plastic, full-ridged with bias	0 Polyamide (PA): standard (PA/black)	
		050 [1.97]	066 [2.60]						
0030 02	Crossbar on outside bend Crossbar on inside bend Opens on inside of bend	060 [2.36]	076 [2.99]			075 ¹⁾ [2.95]	1 Plastic, full-ridged without bias	7 ESD (PA/light gray)	
		075 [2.95]	091 [3.58]						
0030 03	Cover on outside of bend Cover on inside of bend Opens on outside bend	085 [3.35]	101 [3.98]			100 [3.94]		9 Special version (on request)	
		100 [3.94]	116 [4.57]						
0030 04	Cover on outside of bend Cover on inside of bend Opens on inside of bend	125 [4.92]	141 [5.55]			125 [4.92]			
		150 [5.91]	166 [6.54]						
0030 05	Cover on outside of bend Crossbar on inside bend Opens on outside bend	200 [7.87]	216 [8.50]			150 [5.91]			
0030 06	Cover on outside of bend Crossbar on inside bend Opens on inside of bend					200 [7.87]			
0030 07	Crossbar on outside bend Cover on inside of bend Opens on outside bend					250 [9.84]			
0030 08	Crossbar on outside bend Cover on inside of bend Opens on inside of bend					300 [11.81]			

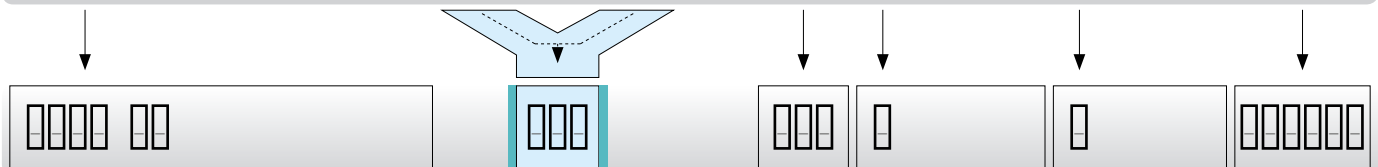

ORDERING EXAMPLE: 0030 040 060 0 0 000049

Crossbar on outside bend, crossbar on inside bend, can be opened from outside bend
 Inside width 1.57 in.; radius 2.36 in.
 Plastic crossbar, full-ridged with bias, material black-colored polyamide
 Chain length 49 in. (25 links)

¹⁾ only for Version 01 and 02

SELF-SUPPORTING LENGTH

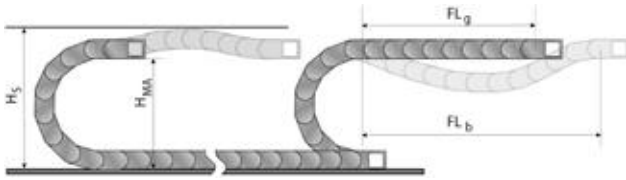

The self-supporting length is the distance between the chain bracket on the moving end and the start of the chain arch.
 The installation variant FL_g offers the lowest load and wear for the cable drag chain.
 The maximum travel parameters (speed and acceleration) can be applied for this variant.

- H_s = Installation height plus safety
- H_{MA} = Height of moving end connection
- FL_g = Self-supporting length, upper run straight
- FL_b = Self-supporting length, upper run bent

LOAD DIAGRAM FOR SELF-SUPPORTING APPLICATIONS

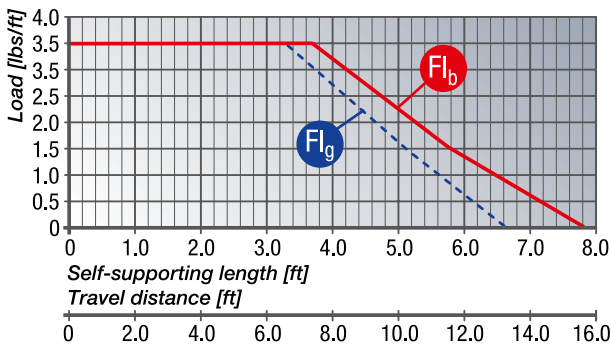

FL_g Self-supporting length, upper run straight
 In the FL_g range, the chain upper run still has a bias, is straight or has a maximum sag of 2.36 inch.

FL_b Self-supporting length, upper run bent
 In the FL_b range, the chain upper run has a sag of more than 2.36 inch, but this is still less than the maximum sag. Where the sag is greater than that permitted in the FL_b range, the application is critical and should be avoided. The self-supporting length can be optimized by using a support for the upper run or a more stable cable drag chain.

Closed cable drag chains (with covers) have a higher unit weight than open chains (with crossbars). This higher weight must be taken into account when calculating the self-supporting length. To the weight of the cabling (cable load, in kg/m), you must add 0.3 kg/m, to account for the higher weight of closed-cover chains.

DETERMINING THE CHAIN LENGTH

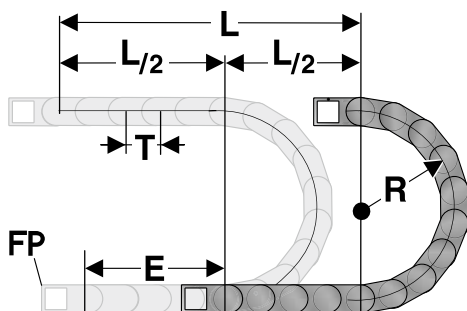

The fixed point of the cable drag chain should be connected in the middle of the travel distance.
 This arrangement gives the shortest connection between the fixed point (FP) and the moving bracket and thus the most efficient chain length.

Chain length calculation = $L/2 + \pi * R + E$
 $\approx 1 \text{ ft chain} = 7 \text{ qty.} \times 1.97 \text{ inch.}$

- E = Distance between entry point and middle of travel distance
- L = Travel distance
- R = Radius
- P = Grid 1.97 inch

INSTALLATION DIMENSIONS

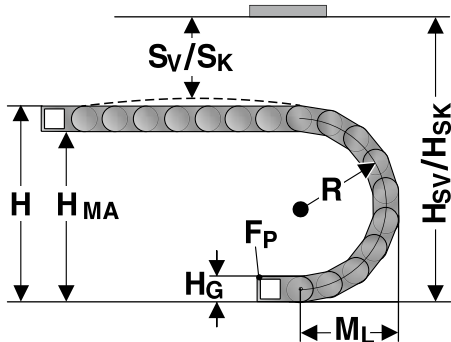

The moving end chain connection is to be screw fixed at height H_{MA} for the respective radius.

Concerning the installed dimensions, you must take into account whether the chain links are equipped with or without bias. For chain links without bias, the "Installed height without bias H_{SK} " value has to be taken into account.

If the chain links are equipped with a bias, the value "Installed height with bias H_{SV} " has to be taken into account.

Radius R	2.36	2.95	3.94	4.92	5.91	7.87	9.84	11.81
Outside height of chain link (H_G)	1.65	1.65	1.65	1.65	1.65	1.65	1.65	1.65
Height of bend (H)	7.15	8.33	10.31	12.27	14.25	18.17	22.11	26.05
Height of moving end connection (H_{MA})	5.50	6.68	8.66	10.62	12.60	16.52	20.46	24.40
Safety margin with bias (S_V)	1.50	1.50	1.50	1.50	1.50	1.50	1.50	1.50
Installation height with bias (H_{SV})	8.65	9.83	11.81	13.77	15.75	19.67	23.61	27.55
Safety margin without bias (S_K)	0.71	0.71	0.71	0.71	0.71	0.71	0.71	0.71
Installation height without bias (H_{SK})	7.86	9.04	11.02	12.98	14.96	18.88	22.82	26.76
Arc projection (M_L)	5.55	6.14	7.13	8.11	9.10	11.06	13.03	15.00

EB 25/30 INSERT PANEL

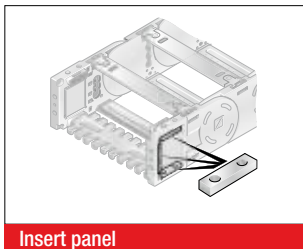

To fix the chain connection, the insert panels can be inserted above, below or on the side and are available with threads or through-holes.

Type	Order No.	Description	Holes inch	Thread
EB 25/30-FG V2A	030100005502	Insert panel with thread		M5x0,8
EB 25/30-FB V2A	030100005500	Insert panel with through-hole	0.22	

KA 30 CHAIN BRACKET FLEXIBLE

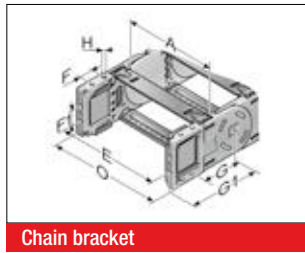

This chain bracket offers universal connection options (top, bottom and front) and is attached to the ends of the chain like a side link. This allows the chain to move right up to the bracket. Each chain requires one male and one female bracket. M5 screws and insert panels are used to secure the brackets in place.
 By default, the chain bracket is supplied with crossbars.
 The chain bracket can then be optionally fitted with crossbar strain relief plates (RS-ZL) or with strain relief using C-rails and type STF bow clamps.

Type	Order No.	Material	Inside width								Outside width of KA 0
			A inch	E inch	F inch	F1 inch	G inch	G1 inch	H	H0 inch	
KA30	KA30ML	Plastic	1.57 – 7.87	A+0.35	0.47	0.47	1.77	2.83	M5	0.22	A+0.71

Configurator chain bracket KA 30

Configurator for chain brackets:

Type KA	Inside width inch/mm	Radius inch/mm	RS-ZL number of pieces	C-profile number of pieces	No. of EB** pieces
KA 30*	3.35/085	9.84/250	2	0	2

Ordering example:

Type = KA 30 = Chain bracket flexible for MP 30
 Internal width = 3.35 in. (085 mm)
 Radius = 9.84 in. (250 mm)
 Crossbar-strain relief (RS-ZL) = 2 pieces
 C-rail = 0 pieces
 Insert panel (EB) = 2 pieces

* One set of chain brackets is needed per chain, containing female and male end

** Two insert panels (EB) are needed per connection element

Note:

For an exact determination of the chain bracket, the inside width and radius are absolutely essential. Optionally, crossbar strain relief plates (RS-ZL), C-sections and insert panels (EB) can be chosen.

MP 30 SEPARATOR / SHELF SUPPORT

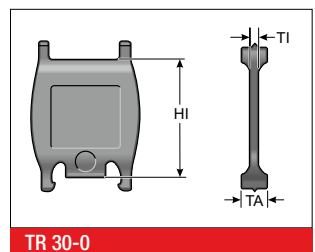
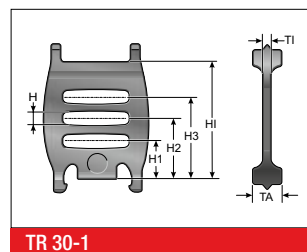
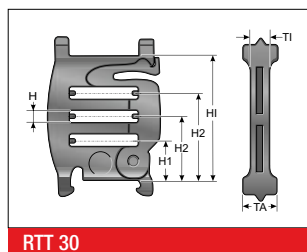
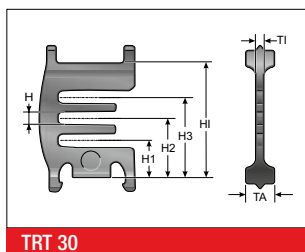

We recommend that separators be used if multiple round cables

or conduits with differing diameters are to be installed.

Type	Order No.	Description	Version	TI inch	TA inch	H inch	H1 inch	H2 inch	H3 inch	HI inch
TR 30-0	030100009300	Separator, closed	lockable	0.09	0.31					1.18
TR 30-1	030100009400	Separator, open	lockable	0.09	0.31	0.13	0.37	0.59	0.81	1.18
TRT 30	030100009200	Separator, divisible	lockable	0.09	0.31	0.13	0.37	0.59	0.81	1.18
RTT 30	030100006500	Shelf support, divisible	lockable	0.18	0.31	0.13	0.37	0.59	0.81	1.18

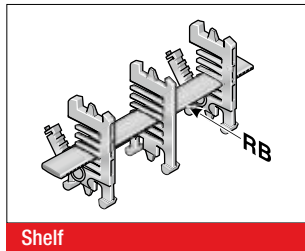
RB-3 SHELF

In connection with at least two separable shelf supports (RTT), the shelf becomes a shelving system. The additional levels prevent cables from criss-crossing and minimize the friction between them.

Type	Order No.	Description	Width inch	Inside width inch
RB 039-3	030100003900	Shelf	1.52	1.57
RB 041-3	1000004103	Shelf	1.62	1.97
RB 044-3	1000004403	Shelf	1.72	1.97
RB 046-3	1000004603	Shelf	1.81	1.97
RB 049-3	030100004900	Shelf	1.91	1.97
RB 051-3	1000005103	Shelf	2.01	2.36
RB 054-3	1000005403	Shelf	2.11	2.36
RB 056-3	1000005603	Shelf	2.21	2.36
RB 059-3	030100005900	Shelf	2.31	2.36
RB 061-3	1000006103	Shelf	2.41	2.95
RB 064-3	1000006403	Shelf	2.50	2.95
RB 066-3	1000006603	Shelf	2.60	2.95
RB 069-3	1000006903	Shelf	2.70	2.95
RB 071-3	1000007103	Shelf	2.80	2.95
RB 074-3	030100007400	Shelf	2.90	2.95
RB 076-3	1000007603	Shelf	3.00	3.35
RB 079-3	1000007903	Shelf	3.09	3.35
RB 081-3	1000008103	Shelf	3.19	3.35
RB 084-3	030100008400	Shelf	3.29	3.35
RB 086-3	1000008603	Shelf	3.39	3.94
RB 089-3	1000008903	Shelf	3.49	3.94
RB 091-3	1000009103	Shelf	3.59	3.94
RB 094-3	1000009403	Shelf	3.69	3.94
RB 096-3	1000009603	Shelf	3.78	3.94
RB 099-3	030100009900	Shelf	3.88	3.94
RB 101-3	1000010103	Shelf	3.98	4.53
RB 104-3	1000010403	Shelf	4.08	4.53
RB 106-3	1000010603	Shelf	4.18	4.53
RB 109-3	1000010903	Shelf	4.28	4.53
RB 111-3	1000011103	Shelf	4.37	4.53
RB 114-3	030100011400	Shelf	4.47	4.53
RB 116-3	1000011603	Shelf	4.57	4.92
RB 119-3	1000011903	Shelf	4.67	4.92
RB 121-3	1000012103	Shelf	4.77	4.92
RB 124-3	030100012400	Shelf	4.87	4.92
RB 126-3	1000012603	Shelf	4.96	5.91
RB 129-3	1000012903	Shelf	5.06	5.91

RB-3 SHELF

Type	Order No.	Description	Width inch	Inside width inch
RB 131-3	1000013103	Shelf	5.16	5.91
RB 134-3	1000013403	Shelf	5.26	5.91
RB 136-3	1000013603	Shelf	5.36	5.91
RB 139-3	1000013903	Shelf	5.46	5.91
RB 141-3	1000014103	Shelf	5.56	5.91
RB 144-3	1000014403	Shelf	5.65	5.91
RB 146-3	1000014603	Shelf	5.75	5.91
RB 149-3	030100014900	Shelf	5.85	5.91
RB 151-3	1000015103	Shelf	5.95	6.89
RB 154-3	1000015403	Shelf	6.05	6.89
RB 156-3	1000015603	Shelf	6.15	6.89
RB 159-3	1000015903	Shelf	6.24	6.89
RB 161-3	1000016103	Shelf	6.34	6.89
RB 164-3	1000016403	Shelf	6.44	6.89
RB 166-3	1000016603	Shelf	6.54	6.89
RB 169-3	1000016903	Shelf	6.64	6.89
RB 174-3	030100017400	Shelf	6.83	6.89
RB 176-3	1000017603	Shelf	6.93	7.87
RB 179-3	1000017903	Shelf	7.03	7.87
RB 181-3	1000018103	Shelf	7.13	7.87
RB 184-3	1000018403	Shelf	7.23	7.87
RB 186-3	1000018603	Shelf	7.33	7.87
RB 189-3	1000018903	Shelf	7.43	7.87
RB 191-3	1000019103	Shelf	7.52	7.87
RB 194-3	1000019403	Shelf	7.62	7.87
RB 196-3	1000019603	Shelf	7.72	7.87
RB 199-3	030100019900	Shelf	7.82	7.87

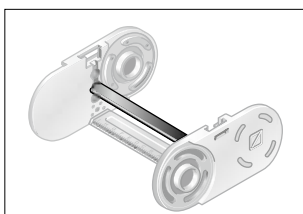
RBD-3 SOLID SHELF FLOOR

Shelf, end-to-end RBD

The shelf RBD creates a horizontal separation over the entire width of the chain link. When used together with the TRT 30 separator, an additional, vertical division can be realized.

Type	Order No.	Description	Width inch	Inside width inch
RBD 040-3	030100004001	Shelf, end-to-end	1.57	1.57
RBD 050-3	030100005001	Shelf, end-to-end	1.97	1.97
RBD 060-3	030100006001	Shelf, end-to-end	2.36	2.36
RBD 075-3	030100007501	Shelf, end-to-end	2.95	2.95
RBD 085-3	030100008501	Shelf, end-to-end	3.35	3.35
RBD 100-3	030100010001	Shelf, end-to-end	3.94	3.94

RE 30 H-SHAPED SHELF UNIT

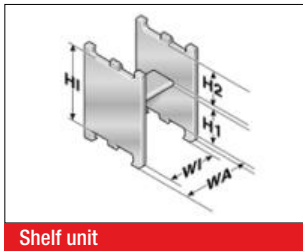

One-piece shelving system, the shelf cannot be varied in height.

Shelf unit

Type	Order No.	Description	WA inch	WI inch	H1 inch	H2 inch	HI inch
RE 30/15	100000301510	H-shaped shelf unit	0.79	0.59	0.62	0.46	1.17
RE 30/32 K5	100000303210	H-shaped shelf unit	1.47	1.28	0.62	0.46	1.17

MP 30 BRUSH SUPPORT

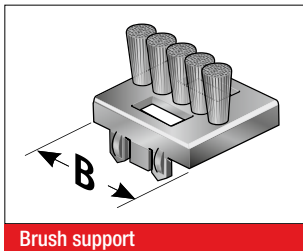

Brush support

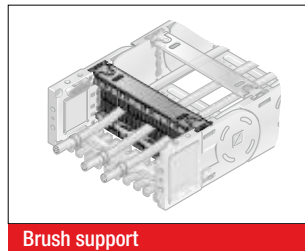

Brush support

The cables in the neutral strand are routed through the brush supports. This innovative solution was developed especially for applications where cables are subjected to higher levels of wear from cyclical movement.

Type	Order No.	Description	Width inch
BT 20-30, completely	030100009702	Brush support	0.79
BT 25-30, completely	030100009802	Brush support	0.98

RS-ZL-3 CROSSBAR STRAIN RELIEF PLATE

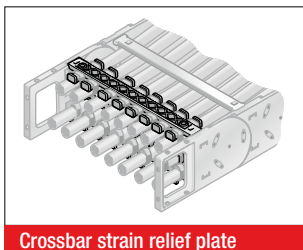

Crossbar strain relief plate

Fixed integrated crossbar strain relief plates in the chain brackets. Tailored to all crossbar widths up to 7.87 inch. May be assembled on the inside and outside bends at both chain endings.

Type	Order No.	Description	Inside width inch
RS-ZL 040-3	030104000010	Crossbar strain relief plate	1.57
RS-ZL 050-3	030105000010	Crossbar strain relief plate	1.97
RS-ZL 060-3	030106000010	Crossbar strain relief plate	2.36
RS-ZL 075-3	030107500010	Crossbar strain relief plate	2.95
RS-ZL 085-3	030108500010	Crossbar strain relief plate	3.35
RS-ZL 100-3	030110000010	Crossbar strain relief plate	3.94
RS-ZL 125-3	030112500010	Crossbar strain relief plate	4.92
RS-ZL 150-3	030115000010	Crossbar strain relief plate	5.91
RS-ZL 200-3	030120000010	Crossbar strain relief plate	7.87

STRAIN RELIEF WITH STEEL FIX

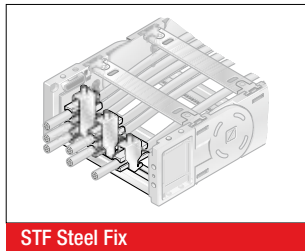
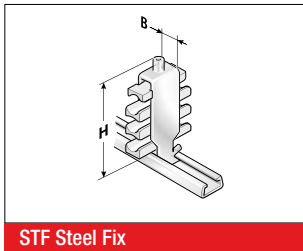

C-rails (galvanized) for permanent integration, for accommodating the Steel Fix bow clamps in the chain brackets. The bow clamps can take up to 3 cables and are suitable for C-rails with a groove width of 0.43 in (11 mm). Due to the design of the trough elements, a cable preserving cable guidance is ensured. May be assembled on the inside and outside bends at both chain endings. The overall height stated is a guide only. The actual height is, amongst other things, dependent on the diameter and the quality of the cable. A safety distance of 0.39 in (10 mm) at the fixed point above the strain relief must be kept during gliding applications.

Type	Order No.	Description	Seats qty.	Cable Ø inch	Width (B) inch	Total height (H) inch
Single clamp (for one cable)						
STF 12-1 Steel Fix	81661801	Hooped clamp	1	0.24 – 0.47	0.63	2.17
STF 14-1 Steel Fix	81661802	Hooped clamp	1	0.47 – 0.55	0.71	2.05
STF 16-1 Steel Fix	81661803	Hooped clamp	1	0.55 – 0.63	0.79	2.13
STF 18-1 Steel Fix	81661804	Hooped clamp	1	0.63 – 0.71	0.87	2.20
STF 20-1 Steel Fix	81661805	Hooped clamp	1	0.71 – 0.79	0.94	2.32
STF 22-1 Steel Fix	81661806	Hooped clamp	1	0.79 – 0.87	1.02	2.40
STF 26-1 Steel Fix	81661807	Hooped clamp	1	0.87 – 1.02	1.18	2.76
STF 30-1 Steel Fix	81661808	Hooped clamp	1	1.02 – 1.18	1.34	2.91
STF 34-1 Steel Fix	81661809	Hooped clamp	1	1.18 – 1.34	1.50	3.07
STF 38-1 Steel Fix	81661810	Hooped clamp	1	1.34 – 1.50	1.65	3.23
STF 42-1 Steel Fix	81661811	Hooped clamp	1	1.50 – 1.65	1.81	3.58
Double clamp (for two cables)						
STF 12-2 Steel Fix	81661821	Hooped clamp	2	0.24 – 0.47	0.63	2.87
STF 14-2 Steel Fix	81661822	Hooped clamp	2	0.47 – 0.55	0.71	2.91
STF 16-2 Steel Fix	81661823	Hooped clamp	2	0.55 – 0.63	0.79	3.23
STF 18-2 Steel Fix	81661824	Hooped clamp	2	0.63 – 0.71	0.87	3.39
STF 20-2 Steel Fix	81661825	Hooped clamp	2	0.71 – 0.79	0.94	3.58
STF 22-2 Steel Fix	81661826	Hooped clamp	2	0.79 – 0.87	1.02	3.74
STF 26-2 Steel Fix	81661827	Hooped clamp	2	0.87 – 1.02	1.18	4.25
STF 30-2 Steel Fix	81661828	Hooped clamp	2	1.02 – 1.18	1.34	4.76
STF 34-2 Steel Fix	81661829	Hooped clamp	2	1.18 – 1.34	1.50	5.08
Triple clamp (for three cables)						
STF 12-3 Steel Fix	81661841	Hooped clamp	3	0.24 – 0.47	0.63	3.86
STF 14-3 Steel Fix	81661842	Hooped clamp	3	0.47 – 0.55	0.71	3.86
STF 16-3 Steel Fix	81661843	Hooped clamp	3	0.55 – 0.63	0.79	4.13
STF 18-3 Steel Fix	81661844	Hooped clamp	3	0.63 – 0.71	0.87	4.37
STF 20-3 Steel Fix	81661845	Hooped clamp	3	0.71 – 0.79	0.94	4.65
STF 22-3 Steel Fix	81661846	Hooped clamp	3	0.79 – 0.87	1.02	5.12

LOWERED FIXING POINT MP 30

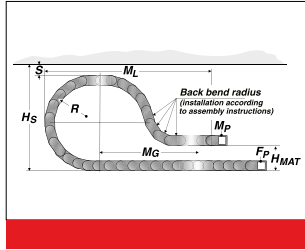
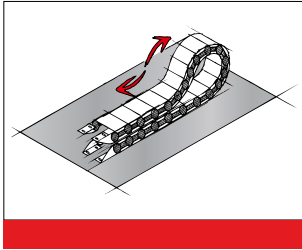

It is sometimes necessary to lower the height of the moving attachment point.
 In such cases, modifications to the chain layout should be noted (e.g. extension of chain).
 Please contact our application engineers.

3.94	3.94	1.97	11.50	11.81	4	3
4.92	3.94	1.97	13.46	13.58	5	3
5.91	3.94	1.97	15.43	18.50	8	5
7.87	3.94	1.97	19.37	23.82	10	6
9.84	3.94	1.97	23.31	26.77	12	7
11.81	3.94	1.97	27.24	31.69	15	7

MP 30.1/2 REARWARD RADII

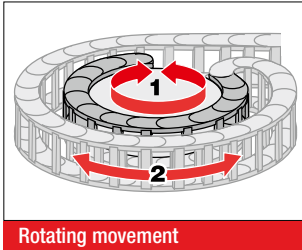

Rotating movement

Side links with forward radius (R) and rearward radius (Rü) allow movements in both directions. This is intended for rotating movements and lowered chain brackets. The appropriate number of washer discs have to be placed into the side links to achieve the rearward radius.

Type	Order No.
AS 30 (RÜ100/R100) left	030100010060
AS 30 RÜ100/R100 right	030100010062
AS 30 (RÜ150/R150) left	030100015060
AS 30 RÜ150/R150 right	030100015062

GUIDE CHANNEL VAW (ALUMINUM / STAINLESS STEEL)



VAW steel galvanized / stainless steel

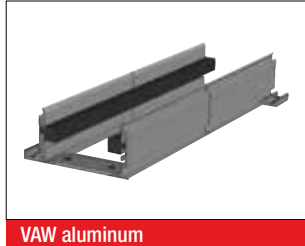

VAW aluminum

A range of variable guide channel systems, constructed from aluminum or stainless steel sections, is available for this cable drag chain.
 The variable guide channel ensures that the cable drag chain is supported and guided securely.

ASSEMBLY

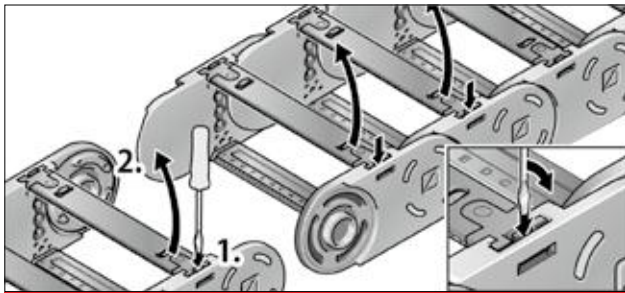

Step 1

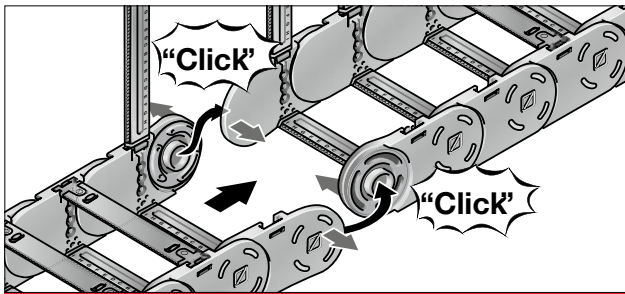

Step 2

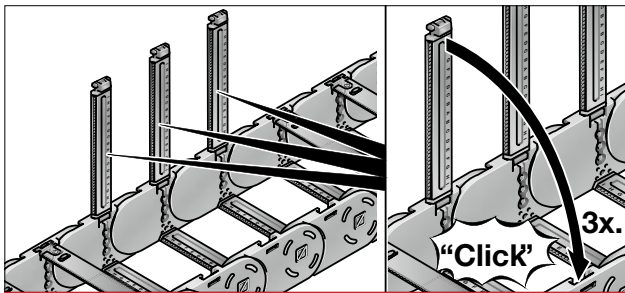

Step 3

DISASSEMBLY

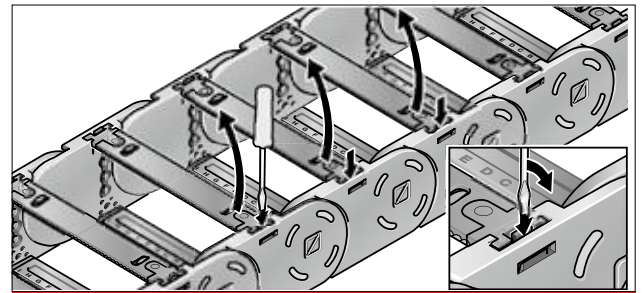

Step 1

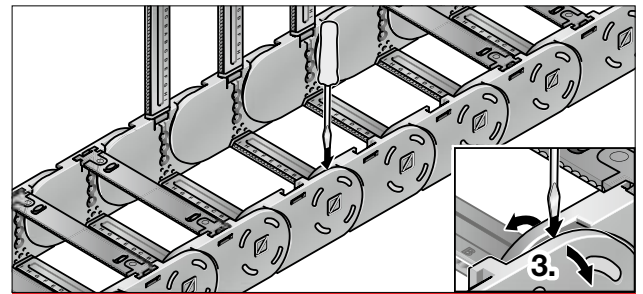

Step 2

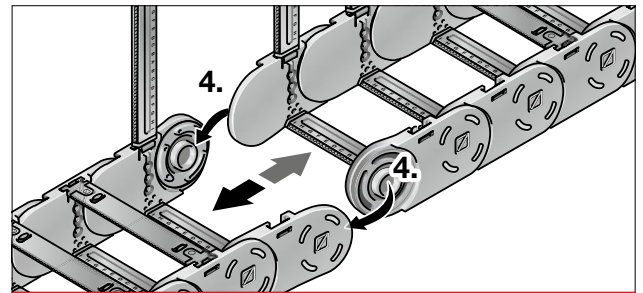

Step 3

MP 32.2
OPEN



MP 32.3
CLOSED



- SLIDING BLOCKS FOR LONGER SERVICE LIFE
- BROAD INTERIOR LAYOUT
- CHAIN BRACKET FLEXIBLE
- PLASTIC OR ALUMINUM VERSION

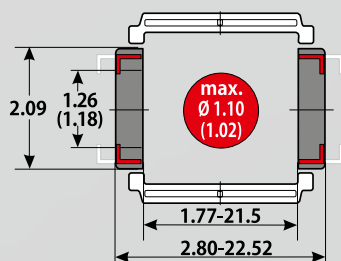

TECHNICAL DATA

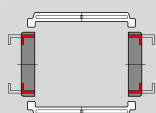

Loading side
Inside and outside bend

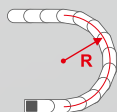

Available radii
3.15 – 9.84 inch

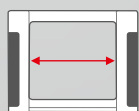

Available interior widths
With plastic crossbar
1.77 – 21.5 inch
With aluminum crossbar / cover
2.64 – 23.62 inch / 1.69 – 23.62 inch

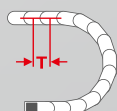

Grid
T = 2.54 inch

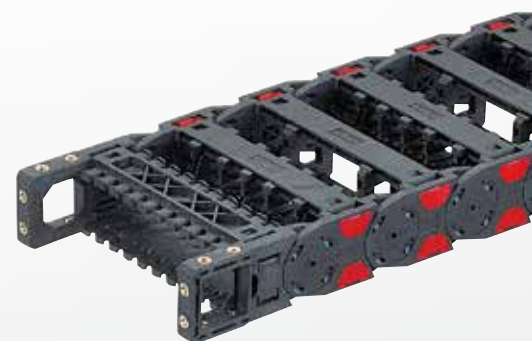

TECHNICAL SPECIFICATIONS

Travel distance gliding L_g max.	328.08 ft.
Travel distance self-supporting L_s max.	see diagram on page 189
Travel distance vertical, hanging L_{vh} max.	131.23 ft.
Travel distance vertical, upright L_{vs} max.	16.40 ft.
Rotated 90°, unsupported L_{90f} max.	3.28 ft.
Speed, gliding V_g max.	16.40 ft/s
Speed, self-supporting V_f max.	65.62 ft/s
Acceleration, gliding a_g max.	82.02 ft/s ²
Acceleration, self-supporting a_s max.	98.43 ft/s ²

Contact our engineering department to meet any higher requirements: efk@murrplastik.de



MATERIAL PROPERTIES

Standard material	Polyamide (PA) black
Service temperature	-22.00 – 248.00 °F
Gliding friction factor	0.30
Static friction factor	0.45
Fire classification	UL 94 HB

Other material properties on request

SHELVING SYSTEM



Separator TR

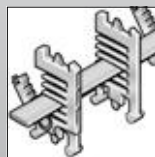

RS shelving system



Crossbar connector RSV

CHAIN BRACKET

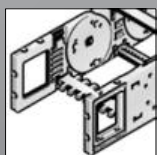

Chain bracket flexible

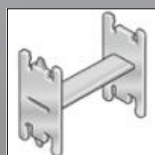

H-shaped shelf unit RE

ACCESSORIES



Sliding block



Bracket bar



Cover

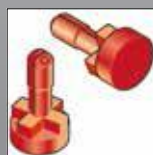

Lock button

GUIDE CHANNELS



VAW steel galvanized / stainless steel

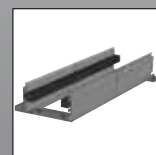

VAW aluminum

STRAIN RELIEF



RS-ZL crossbar strain relief



STF Steel Fix

ORDERING KEY

Dimensions in mm [US inch]

Type code	Variation	Inside width	Outside width	Inside width	Outside width	Radius	Rail variant	Material	Chain length
0322 30	MP 32.2 open Crossbar on outside bend Crossbar on inside bend Opens on inside and outside of bend	045 ¹⁾ [1.77]	071 [2.80]	233 [9.17]	259 [10.20]	080 ¹⁾ [3.15]	0 Plastic, full-ridged with bias	0 Polyamide (PA): standard (PA/black)	
		057 ¹⁾ [2.24]	083 [3.27]	246 [9.69]	272 [10.71]				
0323 44 ²⁾	MP 32.3 closed Cover on outside of bend Cover on inside of bend Opens on inside and outside of bend	062 [2.44]	088 [3.46]	252 [9.92]	278 [10.94]	100 ¹⁾ [3.94]	2 Plastic, half-ridged with bias	5 Polypropylene (PP/blue)	
		071 [2.80]	097 [3.82]	258 [10.16]	284 [11.18]				
		084 [3.31]	110 [4.33]	296 [11.65]	322 [12.68]	120 [4.72]	4 Aluminum full-ridged with bias	7 ESD (PA/light gray)	
		093 [3.66]	119 [4.69]	346 [13.62]	372 [14.65]				
		096 [3.78]	122 [4.80]	350 [13.78]	376 [14.80]	150 [5.91]	6 Aluminum half-ridged with bias	9 Special version (on request)	
		104 [4.09]	130 [5.12]	358 [14.09]	384 [15.12]				
		107 [4.21]	133 [5.24]	371 [14.61]	397 [15.63]	200 [7.87]	9 Special version (on request)		
		121 [4.76]	147 [5.79]	396 [15.59]	422 [16.61]				
		133 [5.24]	159 [6.26]	421 [16.57]	447 [17.60]	250 [9.84]			
		144 [5.67]	170 [6.69]	446 [17.56]	472 [18.58]				
		146 [5.75]	172 [6.77]	496 [19.53]	522 [20.55]				
		158 [6.22]	184 [7.24]	546 [21.50]	572 [22.52]				
		164 [6.46]	190 [7.48]						
		171 [6.73]	197 [7.76]						
		182 [7.17]	208 [8.19]						
		196 [7.72]	222 [8.74]						
		208 [8.19]	234 [9.21]						
		220 [8.66]	246 [9.69]						

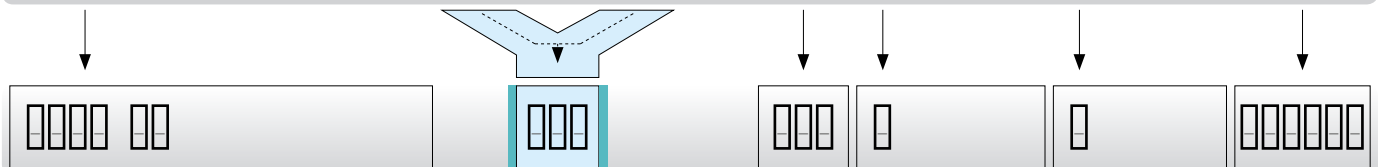

ORDERING EXAMPLE: 0322 045 080 0 0 000050

Crossbar on outside bend, crossbar on inside bend, can be opened from inside and outside bend
 Inside width 1.77 in.; radius 3.15 in.
 Plastic crossbar, full-ridged with bias, material black-colored polyamide
 Chain length 50 in. (20 links)

¹⁾ for Variant 30 only
²⁾ reduced inner height, reduced max. cable diameter, see chain window drawing on previous page

NOTE ON CONFIGURATION

Aluminum crossbars:

Aluminum crossbars in 0.04 in (1 mm) width sizes for inner widths from 2.64 inch – 23.62 inch are available for delivery.

Aluminum covers:

Aluminum covers in 0.04 in (1 mm) width sizes for inner widths from 1.69 inch – 23.62 inch are available for delivery.

Crossbar connector and crossbar strain relief plate:

Once inside widths exceed 9.69 inch, we recommend the deployment of crossbar connectors (RSV).

Crossbar connectors cannot be used in conjunction with covers made from plastic or aluminum.

If crossbar strain relief plates (RS-ZL) are to be deployed in the chain brackets, take standard inside widths into account.

For detailed information, please consult the corresponding product documentation.

SELF-SUPPORTING LENGTH

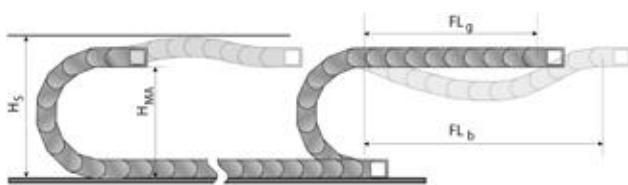

The self-supporting length is the distance between the chain bracket on the moving end and the start of the chain arch.

The installation variant FL_g offers the lowest load and wear for the cable drag chain.

The maximum travel parameters (speed and acceleration) can be applied for this variant.

H_s = Installation height plus safety

H_{MA} = Height of moving end connection

FL_g = Self-supporting length, upper run straight

FL_b = Self-supporting length, upper run bent

LOAD DIAGRAM FOR SELF-SUPPORTING APPLICATIONS

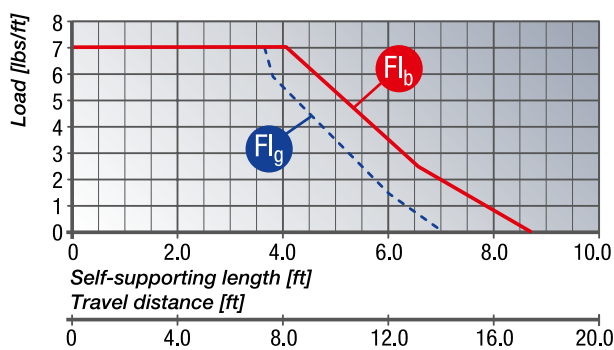

FL_g Self-supporting length, upper run straight

In the FL_g range, the chain upper run still has a bias, is straight or has a maximum sag of 2.76 inch.

FL_b Self-supporting length, upper run bent

In the FL_b range, the chain upper run has a sag of more than 2.76 inch, but this is still less than the maximum sag.

Where the sag is greater than that permitted in the FL_b range, the application is critical and should be avoided. The self-supporting length can be optimized by using a support for the upper run or a more stable cable drag chain.

Closed cable drag chains (with covers) have a higher unit weight than open chains (with crossbars). This higher weight must be taken into account when calculating the self-supporting length. To the weight of the cabling (cable load, in lbs/ft (kg/m)), you must add 1.00 lbs/ft (1.5 kg/m), to account for the higher weight of closed-cover chains.

DETERMINING THE CHAIN LENGTH

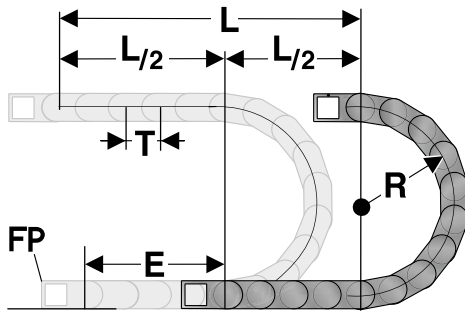

The fixed point of the cable drag chain should be connected in the middle of the travel distance. This arrangement gives the shortest connection between the fixed point (FP) and the moving bracket and thus the most efficient chain length.

Chain length calculation = $L/2 + \pi * R + E$
 $\approx 1 \text{ ft chain} = 5 \text{ qty.} \times 2.54 \text{ inch.}$

- E = Distance between entry point and middle of travel distance
- L = Travel distance
- R = Radius
- P = Grid 2.54 inch

INSTALLATION DIMENSIONS

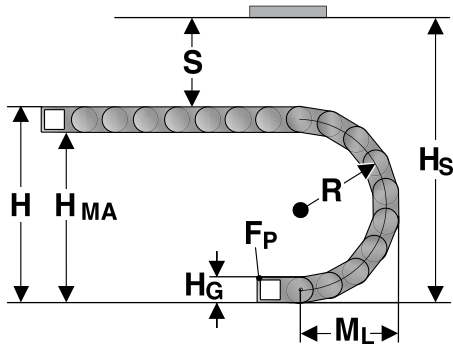

The moving end chain connection is to be screw fixed at height H_{MA} for the respective radius. For the installed dimension the "Installed height H_s " value has to be taken into account.

Radius R	3.15	3.94	4.72	5.91	7.87	9.84
Outside height of chain link (H_o)	2.09	2.09	2.09	2.09	2.09	2.09
Height of bend (H)	9.17	10.75	12.31	14.69	18.61	22.55
Height of moving end connection (H_{MA})	7.08	8.66	10.22	12.60	16.52	20.46
Safety margin (S)	1.18	1.18	1.18	1.18	1.18	1.18
Installation height (H_s)	10.35	11.93	13.49	15.87	19.79	23.73
Arc projection (M_L)	7.13	7.92	8.70	9.89	11.85	13.82

POWERLINE PLASTIC CROSSBAR



The crossbars connect the two side runs of the cable drag chain. The crossbar length is synonymous with the inside width of the cable drag chain.

Type	Order No.	Description	Inside width inch
BS 045-5	052004500000	Crossbar	1.77
BS 057-5	052005700000	Crossbar	2.24
BS 062-5	052006200000	Crossbar	2.44
BS 071-5	052007100000	Crossbar	2.80
BS 084-5	052008400000	Crossbar	3.31
BS 093-5	052009300000	Crossbar	3.66
BS 096-5	052009600000	Crossbar	3.78
BS 104-5	052010400000	Crossbar	4.09
BS 107-5	052010700000	Crossbar	4.21
BS 121-5	052012100000	Crossbar	4.76
BS 133-5	052013300000	Crossbar	5.24
BS 144-5	052014400000	Crossbar	5.67
BS 146-5	052014600000	Crossbar	5.75
BS 158-5	052015800000	Crossbar	6.22
BS 164-5	052016400000	Crossbar	6.46
BS 171-5	052017100000	Crossbar	6.73
BS 182-5	052018200000	Crossbar	7.17
BS 196-5	052019600000	Crossbar	7.72
BS 208-5	052020800000	Crossbar	8.19
BS 220-5	052022000000	Crossbar	8.66
BS 233-5	052023300000	Crossbar	9.17
BS 246-5	052024600000	Crossbar	9.69
BS 252-5	052025200010	Crossbar	9.92
BS 258-5	052025800000	Crossbar	10.16
BS 296-5	052029600000	Crossbar	11.65
BS 346-5	052034600000	Crossbar	13.62
BS 350-5	052035000000	Crossbar	13.78
BS 358-5	052035800000	Crossbar	14.09
BS 371-5	052037100000	Crossbar	14.61
BS 396-5	052039600000	Crossbar	15.59
BS 421-5	052042100000	Crossbar	16.57
BS 446-5	052044600000	Crossbar	17.56
BS 496-5	052049600000	Crossbar	19.53
BS 546-5	052054600000	Crossbar	21.50

KA 32 CHAIN BRACKET

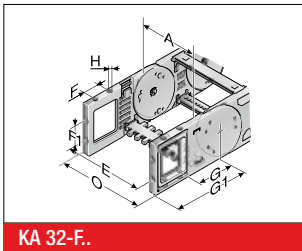

This chain bracket offers universal connection options (top, bottom and front) and is attached to the ends of the chain like a side link. This allows the chain to move right up to the bracket. Each chain requires one male and one female bracket. M5 screws are used to secure the brackets in place. Extrusion-coated metal bushes with either a through-hole (-FB) or a threaded hole (-FG) ensure the permanent, high-strength transmission of even extreme forces onto the cable drag chain.

Type	Order No.	Material	Version	Inside width A inch	E inch	F inch	F1 inch	G inch	G1 inch	H inch	H0 inch	Outside width of KA O inch
KA 32-FB	0321000054	Plastic	with bush	1.77 – 21.50	A+0.55	0.89	0.87	2.28	3.76		0.22	A+1.10
KA 32-FG	0321000055	Plastic	with thread	1.77 – 21.50	A+0.55	0.89	0.87	2.28	3.76	M5		A+1.10

GS 32.2 SLIDING BLOCK

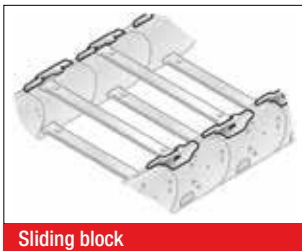

In the case of cable drag chains, sliding blocks are used in a horizontally sliding installation mode (the tight side of the chain slides on the slack side). The sliding blocks are set onto the side links on the interior bend instead of the usual crossbar interlocks; (no tools needed). This forces the chain to slide on the sliding blocks instead on the side links of the chain. Depending on the application, the service life of the cable drag chain may be extended five-fold, by using slide blocks. Information about the minimum bending radius of the cable drag chain at the sliding block insert is listed in the following table.

Type	Order No.	Min. radius inch	Sliding block height inch
GS 32.2	032290400300	4.72	0.16

MP 32 SEPARATOR

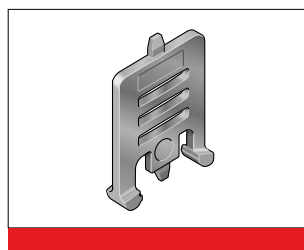
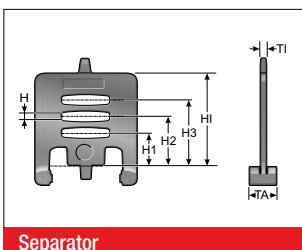

We recommend that separators be used if multiple round cables or conduits with differing diameters are to be installed.

Type	Order No.	Description	Version	TI inch	TA inch	H inch	H1 inch	H2 inch	H3 inch	HI inch
TR 32	032000009200	Separator	lockable	0.12	0.39	0.17	0.41	0.64	0.87	1.26

MP 32.1 SEPARATOR

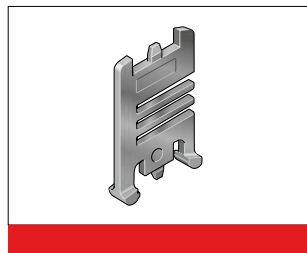
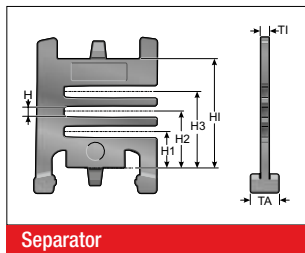

We recommend that separators be used if multiple round cables or conduits with differing diameters are to be installed.

Type	Order No.	Description	Version	TI inch	TA inch	H inch	H1 inch	H2 inch	H3 inch	HI inch
TR 32.1	032200009200	Separator	lockable	0.14	0.31	0.16	0.41	0.65	0.89	1.26

RTT 32 SHELF SUPPORT, DIVISIBLE

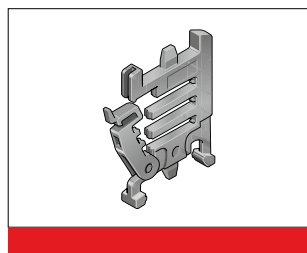
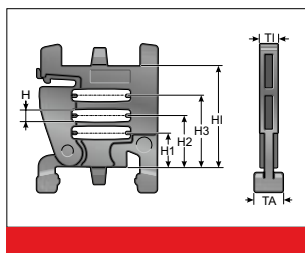

In connection with two separable shelf supports (RTT) with at least one end-to-end shelf (RB) the shelf becomes an easy to fill shelving system. The additional levels prevent cables from criss-crossing and minimize the friction between them.

Type	Order No.	Description	Version	TI inch	TA inch	H inch	H1 inch	H2 inch	H3 inch	HI inch
RTT 32	100090322000	Shelf support, divisible	lockable	0.28	0.31	0.16	0.41	0.65	0.89	1.26

RB-5 SHELF

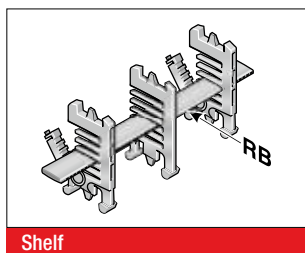

In connection with at least two separable shelf supports (RTT), the shelf becomes a shelving system. The additional levels prevent cables from criss-crossing and minimize the friction between them.

Type	Order No.	Description	Width inch	Inside width inch
RB 028-5	100000002800	Shelf	1.10	1.77
RB 034-5	1000003405	Shelf	1.32	1.77
RB 039-5	1000003905	Shelf	1.54	1.77
RB 045-5	1000004505	Shelf	1.76	2.24
RB 050-5	1000005005	Shelf	1.98	2.24
RB 056-5	10000005601	Shelf	2.20	2.44
RB 062-5	1000006205	Shelf	2.43	2.44

RB-5 SHELF

Type	Order No.	Description	Width inch	Inside width inch
RB 067-5	1000006705	Shelf	2.65	3.31
RB 073-5	1000007305	Shelf	2.87	3.31
RB 078-5	1000007805	Shelf	3.09	3.31
RB 084-5	10000008400	Shelf	3.31	3.31
RB 090-5	1000009005	Shelf	3.53	3.78
RB 095-5	1000009505	Shelf	3.75	3.78
RB 101-5	1000010105	Shelf	3.97	4.21
RB 106-5	1000010605	Shelf	4.19	4.21
RB 112-5	100000011200	Shelf	4.41	4.76
RB 118-5	1000011805	Shelf	4.63	4.76
RB 123-5	1000012305	Shelf	4.85	5.24
RB 129-5	1000012905	Shelf	5.07	5.24
RB 134-5	1000013405	Shelf	5.29	5.67
RB 140-5	100000014000	Shelf	5.51	5.67
RB 146-5	1000014605	Shelf	5.73	6.22
RB 151-5	1000015105	Shelf	5.95	6.22
RB 157-5	1000015705	Shelf	6.17	6.46
RB 162-5	1000016205	Shelf	6.39	6.46
RB 168-5	100000016800	Shelf	6.61	7.17
RB 174-5	1000017405	Shelf	6.83	7.17
RB 179-5	1000017905	Shelf	7.06	7.72
RB 185-5	1000018505	Shelf	7.28	7.72
RB 190-5	1000019005	Shelf	7.50	7.72
RB 196-5	100000019600	Shelf	7.72	7.72
RB 291-5	100000029100	Shelf	11.46	13.62

RSV 32 CROSSBAR CONNECTOR

For crossbars wider than 9.69 inch (246 mm), we recommend the use of crossbar connectors. These prevent deformation to the crossbar under large amounts of additional weight of the chain assembly.

Type	Order No.	Description	TI inch
RSV 32	032000009600	Crossbar connector	0.30
RSV 32 Alu	032000009800	Crossbar connector for aluminum crossbars	0.30

RE 32 H-SHAPED SHELF UNIT

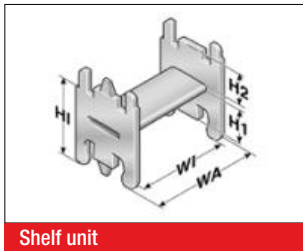

One-piece shelving system, the shelf cannot be varied in height.

Type	Order No.	Description	WA inch	WI inch	H1 inch	H2 inch	HI inch
RE 32/35	100000322010	H-shaped shelf unit	1.70	1.39	0.56	0.56	1.28
RE 32/52	100000323510	H-shaped shelf unit	2.36	2.05	0.56	0.56	1.28
RE 32/75	100000327510	H-shaped shelf unit	3.24	2.93	0.65	0.47	1.28

BS-5 BRACKET BAR



Large-diameter conduits are routed securely by using bracket bars (BS). This bar is installed on the crossbars or the covers of the cable drag chain. The bracket bar can be installed on both the inside and outside bend.

The bracket bar support (BSH) is used to attach the bars to PowerLine series crossbars. Two bracket bar supports are required for each bar.

Type	Order No.	Description	Conduit diameter max. inch	Installation height inch	Inner chain width min. inch
BS 120-5	052412000000	Bracket bar	4.53	5.51	6.46
BS 153-5	052415300000	Bracket bar	5.83	6.69	8.19
BS 187-5	052418700000	Bracket bar	7.17	8.07	9.17
BSH-5	052400000000	Bracket bar support			
Assembly set	052400000001	Assembly set			

D3 CHAIN BRACKET COVER



Self-locking covers close the side mounting window on the flexible chain bracket (KA-FB/FG).

Type	Order No.
Cover D3 KA 32.1-FB/FG	0323888002

MP 32.3 CHAIN BRACKET CANOPY



Constructed from aluminum, the canopies for the flexible chain bracket (KA-FB/FG) ensure a continuously closed system for chains with covers.

Canopy for chain bracket, fixed point outside bend: Type and Order No. configurator



Type:	KA 32.1 FB/FG AB	Inside width	2-2
Order No.:	0321	Inside width	060

Canopy for chain bracket, fixed point inside bend: Type and Order No. configurator

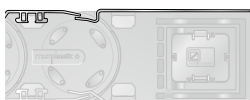

Type:	KA 32.1 FB/FG IB	Inside width	2-2
Order No.:	0321	Inside width	058

Canopy for chain bracket, moving end outside bend: Type and Order No. configurator



Type:	KA 32.1 FB/FG AB	Inside width	1-2
Order No.:	0321	Inside width	059

Canopy for chain bracket, moving end outside bend: Type and Order No. configurator

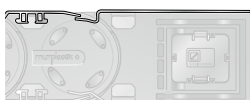

Type:	KA 32.1 FB/FG IB	Inside width	1-2
Order No.:	0321	Inside width	057

Ordering example:

0321096058 KA 32.1 FB/FG IB 096 2-2

Chain bracket canopy at fixing point in inside bend, for inside width of 3.78 in. (96 mm).

RS-ZL-5 CROSSBAR STRAIN RELIEF PLATE

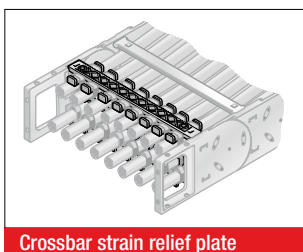

Fixed integrated crossbar strain relief plates in the chain brackets. Tailored to all crossbar widths up to 9.69 inch (246 mm). May be assembled on the inside and outside bends at both chain endings.

Type	Order No.	Description	Inside width inch
RS-ZL 045-5	052004500010	Crossbar strain relief plate	1.77
RS-ZL 057-5	052005700010	Crossbar strain relief plate	2.24
RS-ZL 062-5	052006200010	Crossbar strain relief plate	2.44
RS-ZL 071-5	052007100010	Crossbar strain relief plate	2.80
RS-ZL 084-5	052008400010	Crossbar strain relief plate	3.31
RS-ZL 093-5	052009300010	Crossbar strain relief plate	3.66
RS-ZL 096-5	052009600010	Crossbar strain relief plate	3.78

RS-ZL-5 CROSSBAR STRAIN RELIEF PLATE

Type	Order No.	Description	Inside width inch
RS-ZL 104-5	052010400010	Crossbar strain relief plate	4.09
RS-ZL 107-5	052010700010	Crossbar strain relief plate	4.21
RS-ZL 121-5	052012100010	Crossbar strain relief plate	4.76
RS-ZL 133-5	052013300010	Crossbar strain relief plate	5.24
RS-ZL 144-5	052014400010	Crossbar strain relief plate	5.67
RS-ZL 146-5	052014600010	Crossbar strain relief plate	5.75
RS-ZL 158-5	052015800010	Crossbar strain relief plate	6.22
RS-ZL 164-5	052016400010	Crossbar strain relief plate	6.46
RS-ZL 171-5	052017100010	Crossbar strain relief plate	6.73
RS-ZL 182-5	052018200010	Crossbar strain relief plate	7.17
RS-ZL 196-5	052019600010	Crossbar strain relief plate	7.72
RS-ZL 208-5	052020800010	Crossbar strain relief plate	8.19
RS-ZL 220-5	052022000010	Crossbar strain relief plate	8.66
RS-ZL 233-5	052023300010	Crossbar strain relief plate	9.17
RS-ZL 246-5	052024600010	Crossbar strain relief plate	9.69

STRAIN RELIEF WITH STEEL FIX

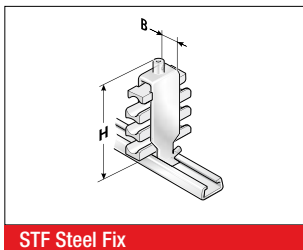

STF Steel Fix

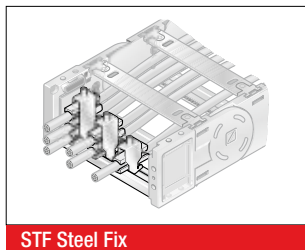

STF Steel Fix

C-rails (galvanized) for permanent integration, for accommodating the Steel Fix bow clamps in the chain brackets. The bow clamps can take up to 3 cables and are suitable for C-rails with a groove width of 0.43 in (11 mm). Due to the design of the trough elements, a cable preserving cable guidance is ensured. May be assembled on the inside and outside bends at both chain endings. The overall height stated is a guide only. The actual height is, amongst other things, dependent on the diameter and the quality of the cable. A safety distance of 0.39 in (10 mm) at the fixed point above the strain relief must be kept during gliding applications.

Type	Order No.	Description	Seats qty.	Cable Ø inch	Width (B) inch	Total height (H) inch
Single clamp (for one cable)						
STF 12-1 Steel Fix	81661801	Hooped clamp	1	0.24 – 0.47	0.63	2.17
STF 14-1 Steel Fix	81661802	Hooped clamp	1	0.47 – 0.55	0.71	2.05
STF 16-1 Steel Fix	81661803	Hooped clamp	1	0.55 – 0.63	0.79	2.13
STF 18-1 Steel Fix	81661804	Hooped clamp	1	0.63 – 0.71	0.87	2.20
STF 20-1 Steel Fix	81661805	Hooped clamp	1	0.71 – 0.79	0.94	2.32
STF 22-1 Steel Fix	81661806	Hooped clamp	1	0.79 – 0.87	1.02	2.40
STF 26-1 Steel Fix	81661807	Hooped clamp	1	0.87 – 1.02	1.18	2.76
STF 30-1 Steel Fix	81661808	Hooped clamp	1	1.02 – 1.18	1.34	2.91
STF 34-1 Steel Fix	81661809	Hooped clamp	1	1.18 – 1.34	1.50	3.07
STF 38-1 Steel Fix	81661810	Hooped clamp	1	1.34 – 1.50	1.65	3.23
STF 42-1 Steel Fix	81661811	Hooped clamp	1	1.50 – 1.65	1.81	3.58

MP 32.2 OPEN / MP 32.3 CLOSED

Type	Order No.	Description	Seats qty.	Cable Ø inch	Width (B) inch	Total height (H) inch
Double clamp (for two cables)						
STF 12-2 Steel Fix	81661821	Hooped clamp	2	0.24 – 0.47	0.63	2.87
STF 14-2 Steel Fix	81661822	Hooped clamp	2	0.47 – 0.55	0.71	2.91
STF 16-2 Steel Fix	81661823	Hooped clamp	2	0.55 – 0.63	0.79	3.23
STF 18-2 Steel Fix	81661824	Hooped clamp	2	0.63 – 0.71	0.87	3.39
STF 20-2 Steel Fix	81661825	Hooped clamp	2	0.71 – 0.79	0.94	3.58
STF 22-2 Steel Fix	81661826	Hooped clamp	2	0.79 – 0.87	1.02	3.74
STF 26-2 Steel Fix	81661827	Hooped clamp	2	0.87 – 1.02	1.18	4.25
STF 30-2 Steel Fix	81661828	Hooped clamp	2	1.02 – 1.18	1.34	4.76
STF 34-2 Steel Fix	81661829	Hooped clamp	2	1.18 – 1.34	1.50	5.08
Triple clamp (for three cables)						
STF 12-3 Steel Fix	81661841	Hooped clamp	3	0.24 – 0.47	0.63	3.86
STF 14-3 Steel Fix	81661842	Hooped clamp	3	0.47 – 0.55	0.71	3.86
STF 16-3 Steel Fix	81661843	Hooped clamp	3	0.55 – 0.63	0.79	4.13
STF 18-3 Steel Fix	81661844	Hooped clamp	3	0.63 – 0.71	0.87	4.37
STF 20-3 Steel Fix	81661845	Hooped clamp	3	0.71 – 0.79	0.94	4.65
STF 22-3 Steel Fix	81661846	Hooped clamp	3	0.79 – 0.87	1.02	5.12

MP 32/41 LOCK BUTTON

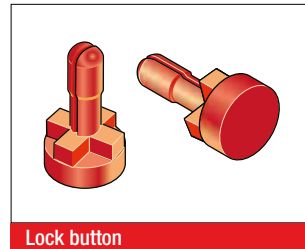
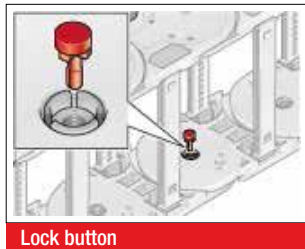
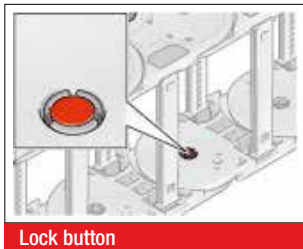

To increase the side stability we recommend the use of lock buttons during strong lateral acceleration or when installed “laying

on the side (turned 90°) without support”.

Type	Order No.
MP32/41 lock button	04100008000

MP 32 LOWERED FIXING POINT

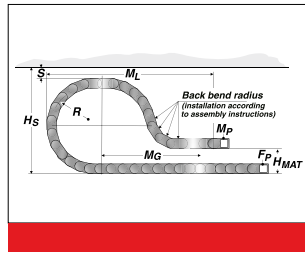
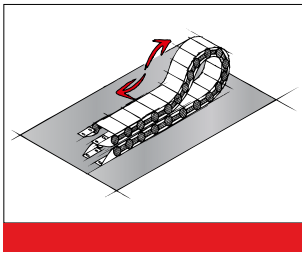

It is sometimes necessary to lower the height of the moving attachment point.

In such cases, modifications to the chain layout should be noted (e.g. extension of chain).

Please contact our application engineers.

Radius R inch	Height of moving end connection (H _{MA}) inch	Safety margin (S) inch	Installation height incl. safety (H _S) inch	Projection (M _I) inch	Additional links qty.	of which additional back chain links qty.
7.87	8.27	1.97	20.59	28.35	14	3
9.84	9.06	1.97	24.53	34.65	17	3

MP 32.2 REARWARD RADII

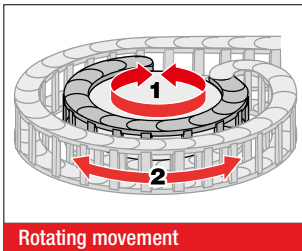

Rotating movement

Side links with forward radius (R) and rearward radius (R_ü) allow movements in both directions. This is intended for rotating movements and lowered chain brackets. Rotation movements are only possible with open variants.

Type	Order No.	Radius inch	Back radius inch
SR 32.2 RK080 (RÜ200/R120)	032200008060	4.72	7.87
SR 32.2 RK100 (RÜ200/R135)	032200010060	5.31	7.87
SR 32.2 RK120 (RÜ200/R150)	032200012060	5.91	7.87
SR 32.2 RK150 (RÜ200/R170)	032200015060	6.69	7.87
SR 32.2 RK200 (RÜ200/R200)	032200020060	7.87	7.87
SR 32.2 RK250 (RÜ200/R250)	032200025060	9.84	7.87

GUIDE CHANNEL VAW (ALUMINUM / STAINLESS STEEL)



VAW steel galvanized / stainless steel

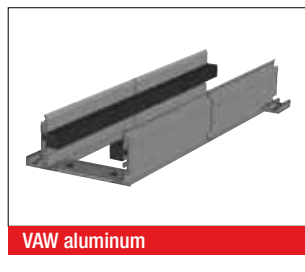

VAW aluminum

A range of variable guide channel systems, constructed from aluminum or stainless steel sections, is available for this cable drag chain.

The variable guide channel ensures that the cable drag chain is supported and guided securely.

ASSEMBLY INSTRUCTION FLEXIBLE CHAIN BRACKET FB/FG

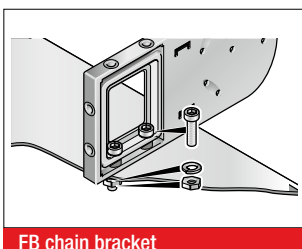

FB chain bracket

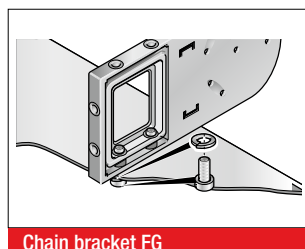

Chain bracket FG

Brass bushes guarantee long-lasting fastening without cold flow in the plastic.

Version KA-FB:

Integrated through-hole fastened down using nut and bolt.

Version KA-FG:

Built-in threads allow for quick and easy on-site mounting, since a screw, including a retaining washer where necessary, is sufficient.

ASSEMBLY

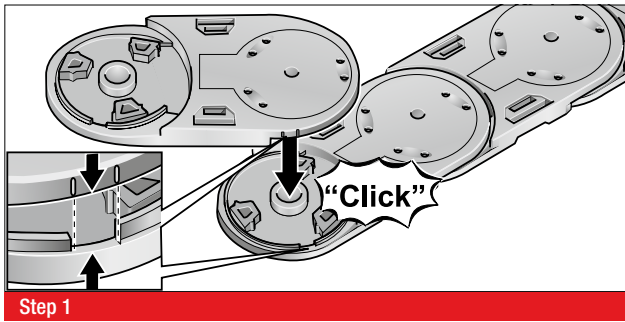

Step 1

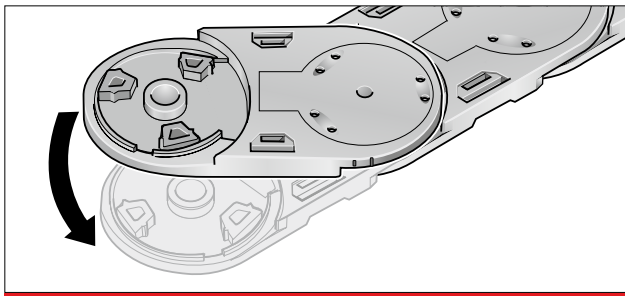

Step 2

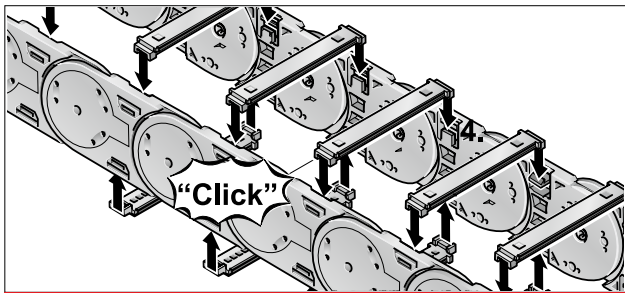

Step 3

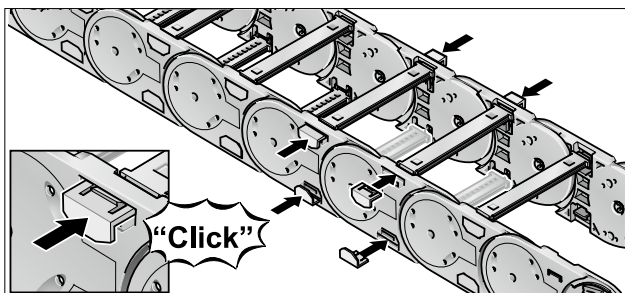

Step 4

DISASSEMBLY

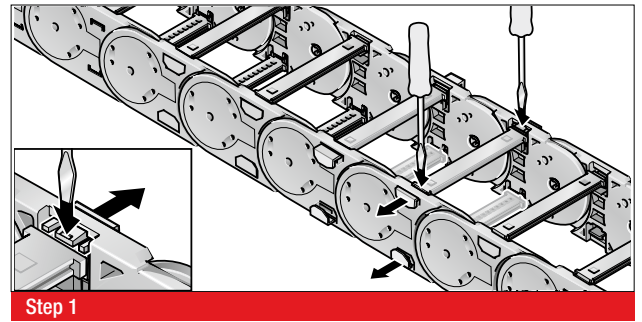

Step 1

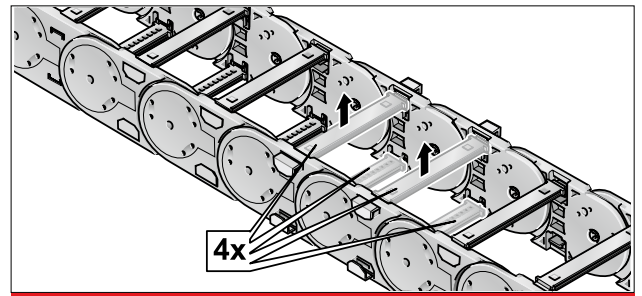

Step 2

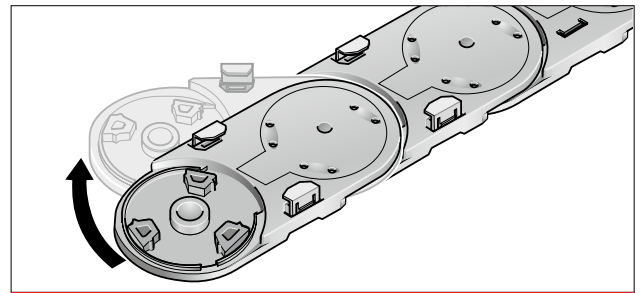

Step 3

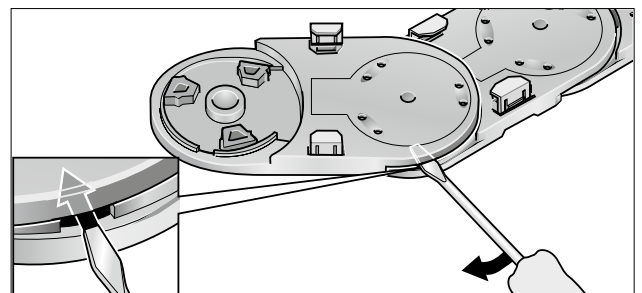

Step 4

MP 41.2 OPEN



MP 41.3 CLOSED

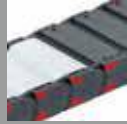

- SLIDING BLOCKS FOR LONGER SERVICE LIFE
- BROAD INTERIOR LAYOUT
- CHAIN BRACKET FLEXIBLE
- PLASTIC OR ALUMINUM VERSION

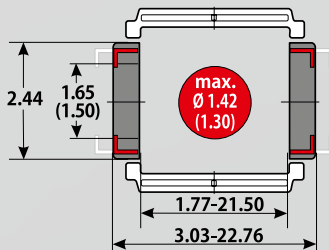

TECHNICAL DATA

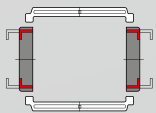

Loading side
Inside and outside bend

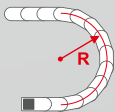

Available radii
3.54 – 13.78 inch

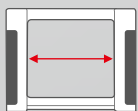

Available interior widths
With plastic crossbar
1.77 – 21.5 inch
With aluminum crossbar / cover
2.64 – 23.62 inch / 1.69 – 23.62 inch

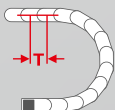

Grid
T = 3.03 inch

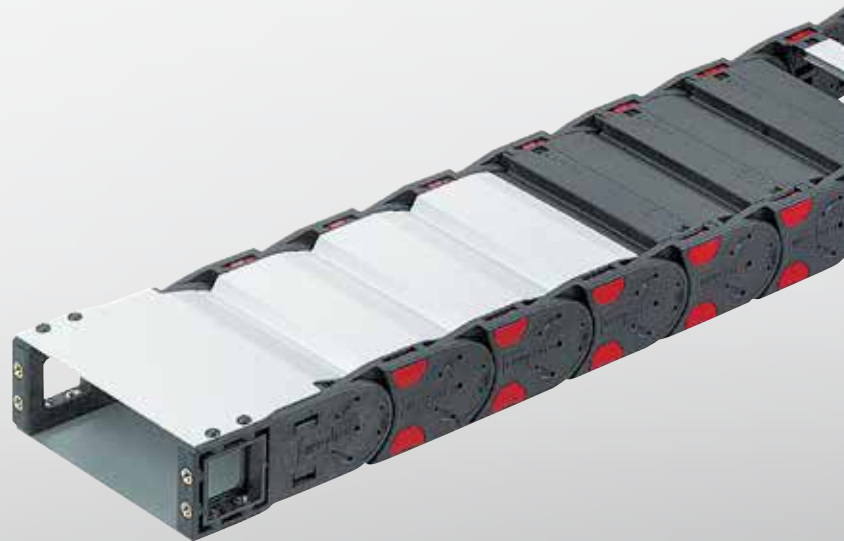



TECHNICAL SPECIFICATIONS

Travel distance gliding L_g max.	393.70 ft.
Travel distance self-supporting L_s max.	see diagram on page 205
Travel distance vertical, hanging L_{vh} max.	164.04 ft.
Travel distance vertical, upright L_{vs} max.	19.69 ft.
Rotated 90°, unsupported L_{90f} max.	3.28 ft.
Speed, gliding V_g max.	16.40 ft/s
Speed, self-supporting V_s max.	65.62 ft/s
Acceleration, gliding a_g max.	82.02 ft/s ²
Acceleration, self-supporting a_s max.	98.43 ft/s ²

Contact our engineering department to meet any higher requirements: efk@murrplastik.de

MATERIAL PROPERTIES

Standard material	Polyamide (PA) black
Service temperature	-22.00 – 248.00 °F
Gliding friction factor	0.30
Static friction factor	0.45
Fire classification	UL 94 HB

Other material properties on request

ACCESSORIES

SHELVING SYSTEM



Separator TR

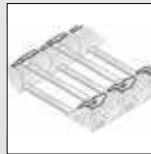

Sliding block

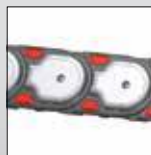

Gliding plate

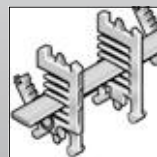

RS shelving system



Bracket bar

CHAIN BRACKET

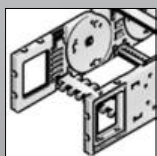

Chain bracket flexible



Crossbar connector RSV

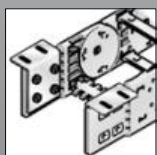

Chain bracket angle



H-shaped shelf unit RE

GUIDE CHANNELS



Cover



VAW steel galvanized / stainless steel

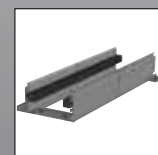

VAW aluminum

STRAIN RELIEF

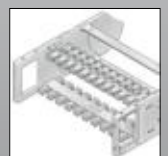

RS-ZL crossbar strain relief



STF Steel Fix

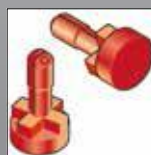

Lock button

ORDERING KEY

Dimensions in mm [US inch]

Type code	Variation	Inside width	Outside width	Inside width	Outside width	Radius	Rail variant	Material	Chain length
0412 30	MP 41.2 open Crossbar on outside bend Crossbar on inside bend Opens on inside and outside of bend	045 ¹⁾ [1.77]	077 [3.03]	233 [9.17]	265 [10.43]	090 ¹⁾ [3.54]	0 Plastic, full-ridged with bias	0 Polyamide (PA): standard (PA/black)	
		057 ¹⁾ [2.24]	089 [3.50]	246 ²⁾ [9.69]	278 ²⁾ [10.94]				
0413 44 ³⁾	MP 41.3 closed Cover on outside of bend Cover on inside of bend Opens on inside and outside of bend	062 ¹⁾ [2.44]	094 [3.70]	252 [9.92]	284 [11.18]	120 ¹⁾ [4.72]	1 Plastic, full-ridged without bias	5 Polypropylene (PP/blue)	
		071 [2.80]	103 [4.06]	258 [10.16]	290 [11.42]				
		084 ²⁾ [3.31]	116 ²⁾ [4.57]	296 ²⁾ [11.65]	328 ²⁾ [12.91]	150 [5.91]	2 Plastic, half-ridged with bias	7 ESD (PA/light gray)	
		093 [3.66]	125 [4.92]	346 [13.62]	378 [14.88]				
		096 ²⁾ [3.78]	128 ²⁾ [5.04]	350 [13.78]	382 [15.04]	175 [6.89]	3 Plastic, half-ridged without bias	9 Special version (on request)	
		104 [4.09]	136 [5.35]	358 [14.09]	390 [15.35]				
		107 [4.21]	139 [5.47]	371 [14.61]	403 [15.87]	200 [7.87]	4 Aluminum full-ridged with bias		
		121 ²⁾ [4.76]	153 ²⁾ [6.02]	396 [15.59]	428 [16.85]				
		133 [5.24]	165 [6.50]	421 [16.57]	453 [17.83]	250 [9.84]	5 Aluminum full-ridged without bias		
		144 [5.67]	176 [6.93]	446 [17.56]	478 [18.82]				
		146 ²⁾ [5.75]	178 ²⁾ [7.01]	496 [19.53]	528 [20.79]	300 [11.81]	6 Aluminum half-ridged with bias		
		158 [6.22]	190 [7.48]	546 [21.50]	578 [22.76]				
		164 [6.46]	196 [7.72]			350 [13.78]	7 Aluminum half-ridged without bias		
		171 ²⁾ [6.73]	203 ²⁾ [7.99]						
		182 ²⁾ [7.17]	214 ²⁾ [8.43]				9 Special version (on request)		
		196 ²⁾ [7.72]	228 ²⁾ [8.98]						
		208 [8.19]	240 [9.45]						
		220 [8.66]	252 [9.92]						

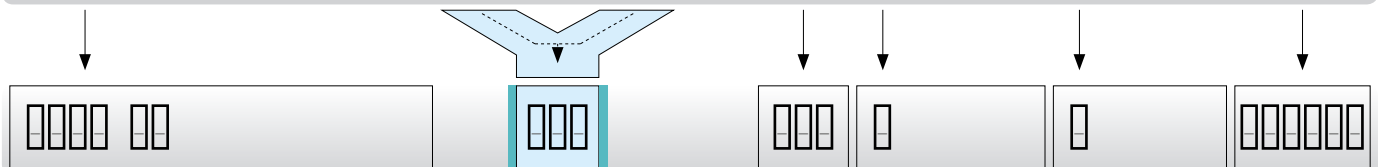

ORDERING EXAMPLE: 0412 045 090 0 0 000054

Crossbar on outside bend, crossbar on inside bend, can be opened from inside and outside bend
 Inside width 1.77 in.; radius 3.54 in.
 Plastic crossbar, full-ridged with bias, material black-colored polyamide
 Chain length 54 in. (18 links)

- ¹⁾ for Variant 30 only
- ²⁾ also available with plastic cover
- ³⁾ reduced inner height, reduced max. cable diameter, see chain window drawing on previous page

NOTE ON CONFIGURATION

Aluminum crossbars:

Aluminum crossbars in 0.04 in (1 mm) width sizes for inner widths from 2.64 inch – 23.62 inch are available for delivery.

Aluminum covers:

Aluminum covers in 0.04 in (1 mm) width sizes for inner widths from 1.69 inch – 23.62 inch are available for delivery.

Crossbar connector and crossbar strain relief plate:

Once inside widths exceed 9.69 inch, we recommend the deployment of crossbar connectors (RSV).

Crossbar connectors cannot be used in conjunction with covers made from plastic or aluminum.

If crossbar strain relief plates (RS-ZL) are to be deployed in the chain brackets, take standard inside widths into account.

For detailed information, please consult the corresponding product documentation.

SELF-SUPPORTING LENGTH

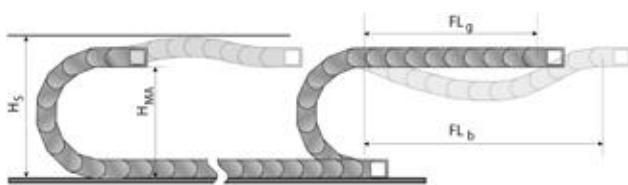

The self-supporting length is the distance between the chain bracket on the moving end and the start of the chain arch.

The installation variant FL_g offers the lowest load and wear for the cable drag chain.

The maximum travel parameters (speed and acceleration) can be applied for this variant.

H_s = Installation height plus safety

H_{MA} = Height of moving end connection

FL_g = Self-supporting length, upper run straight

FL_b = Self-supporting length, upper run bent

LOAD DIAGRAM FOR SELF-SUPPORTING APPLICATIONS

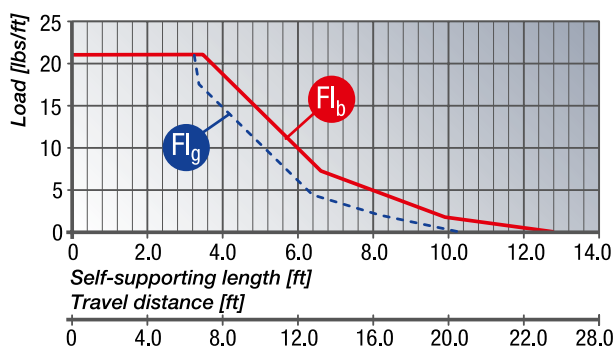

FL_g Self-supporting length, upper run straight

In the FL_g range, the chain upper run still has a bias, is straight or has a maximum sag of 2.76 inch.

FL_b Self-supporting length, upper run bent

In the FL_b range, the chain upper run has a sag of more than 2.76 inch, but this is still less than the maximum sag.

Where the sag is greater than that permitted in the FL_b range, the application is critical and should be avoided. The self-supporting length can be optimized by using a support for the upper run or a more stable cable drag chain.

Closed cable drag chains (with covers) have a higher unit weight than open chains (with crossbars). This higher weight must be taken into account when calculating the self-supporting length. To the weight of the cabling (cable load, in lbs/ft (kg/m)), you must add 1.00 lbs/ft (1.5 kg/m), to account for the higher weight of closed-cover chains.

DETERMINING THE CHAIN LENGTH

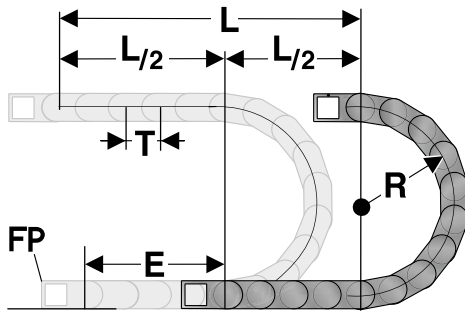

The fixed point of the cable drag chain should be connected in the middle of the travel distance.
 This arrangement gives the shortest connection between the fixed point (FP) and the moving bracket and thus the most efficient chain length.

Chain length calculation = $L/2 + \pi * R + E$
 $\approx 1 \text{ ft chain} = 4 \text{ qty.} \times 3.03 \text{ inch.}$

- E = Distance between entry point and middle of travel distance
- L = Travel distance
- R = Radius
- P = Grid 3.03 inch

INSTALLATION DIMENSIONS

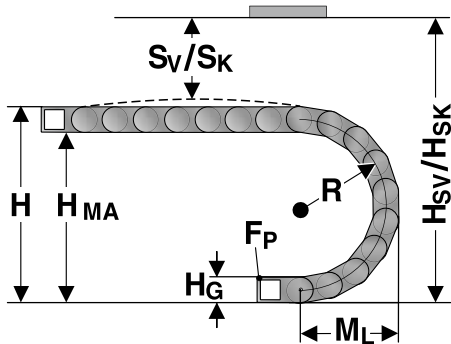

The moving end chain connection is to be screw fixed at height H_{MA} for the respective radius.
 Concerning the installed dimensions, you must take into account whether the chain links are equipped with or without bias. For chain links without bias, the "Installed height without bias H_{SK} " value has to be taken into account.
 If the chain links are equipped with a bias, the value "Installed height with bias H_{SV} " has to be taken into account.

Radius R	3.54	4.72	5.91	6.89	7.87	9.84	11.81	13.78
Outside height of chain link (H_c)	2.44	2.44	2.44	2.44	2.44	2.44	2.44	2.44
Height of bend (H)	9.92	12.28	14.66	16.62	18.58	22.52	26.46	30.40
Height of moving end connection (H_{MA})	7.48	9.84	12.22	14.18	16.14	20.08	24.02	27.96
Safety margin with bias (S_v)	1.18	1.18	1.18	1.18	1.18	1.18	1.18	1.18
Installation height with bias (H_{SV})	11.10	13.46	15.84	17.80	19.76	23.70	27.64	31.58
Safety margin without bias (S_R)	0.59	0.59	0.59	0.59	0.59	0.59	0.59	0.59
Installation height without bias (H_{SK})	10.51	12.87	15.25	17.21	19.17	23.11	27.05	30.99
Arc projection (M_L)	7.99	9.17	10.36	11.34	12.32	14.29	16.26	18.23

POWERLINE PLASTIC CROSSBAR



The crossbars connect the two side runs of the cable drag chain. The crossbar length is synonymous with the inside width of the cable drag chain.

Type	Order No.	Description	Inside width inch
BS 045-5	052004500000	Crossbar	1.77
BS 057-5	052005700000	Crossbar	2.24
BS 062-5	052006200000	Crossbar	2.44
BS 071-5	052007100000	Crossbar	2.80
BS 084-5	052008400000	Crossbar	3.31
BS 093-5	052009300000	Crossbar	3.66
BS 096-5	052009600000	Crossbar	3.78
BS 104-5	052010400000	Crossbar	4.09
BS 107-5	052010700000	Crossbar	4.21
BS 121-5	052012100000	Crossbar	4.76
BS 133-5	052013300000	Crossbar	5.24
BS 144-5	052014400000	Crossbar	5.67
BS 146-5	052014600000	Crossbar	5.75
BS 158-5	052015800000	Crossbar	6.22
BS 164-5	052016400000	Crossbar	6.46
BS 171-5	052017100000	Crossbar	6.73
BS 182-5	052018200000	Crossbar	7.17
BS 196-5	052019600000	Crossbar	7.72
BS 208-5	052020800000	Crossbar	8.19
BS 220-5	052022000000	Crossbar	8.66
BS 233-5	052023300000	Crossbar	9.17
BS 246-5	052024600000	Crossbar	9.69
BS 252-5	052025200010	Crossbar	9.92
BS 258-5	052025800000	Crossbar	10.16
BS 296-5	052029600000	Crossbar	11.65
BS 346-5	052034600000	Crossbar	13.62
BS 350-5	052035000000	Crossbar	13.78
BS 358-5	052035800000	Crossbar	14.09
BS 371-5	052037100000	Crossbar	14.61
BS 396-5	052039600000	Crossbar	15.59
BS 421-5	052042100000	Crossbar	16.57
BS 446-5	052044600000	Crossbar	17.56
BS 496-5	052049600000	Crossbar	19.53
BS 546-5	052054600000	Crossbar	21.50

MP 41.3 PLASTIC COVER



The covers connect the two side runs of the cable drag chain. The cover length is synonymous with the inside width of the cable drag chain.

Type	Order No.	Description	Installation site	Inside width inch
A-413084, outside	041308410000	Cover	Outside bend	3.31
I-413084, inside	041308420000	Cover	Inside bend	3.31
A-413096, outside	041309610000	Cover	Outside bend	3.78
I-413096, inside	041309620000	Cover	Inside bend	3.78
A-413121, outside	041312110000	Cover	Outside bend	4.76
I-413121, inside	041312120000	Cover	Inside bend	4.76
A-413146, outside	041314610000	Cover	Outside bend	5.75
I-413146, inside	041314620000	Cover	Inside bend	5.75
A-413171, outside	041317110000	Cover	Outside bend	6.73
I-413171, inside	041317120000	Cover	Inside bend	6.73
A-413182, outside	041318210000	Cover	Outside bend	7.17
I-413182, inside	041318220000	Cover	Inside bend	7.17
A-413196, outside	041319610000	Cover	Outside bend	7.72
I-413196, inside	041319620000	Cover	Inside bend	7.72
A-413246, outside	041324610000	Cover	Outside bend	9.69
I-413246, inside	041324620000	Cover	Inside bend	9.69
A-413296, outside	041329610000	Cover	Outside bend	11.65
I-413296, inside	041329620000	Cover	Inside bend	11.65

KA 41 CHAIN BRACKET FLEXIBLE

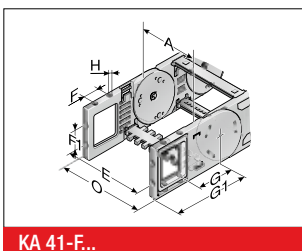

This chain bracket offers universal connection options (top, bottom and front) and is attached to the ends of the chain like a side link. This allows the chain to move right up to the bracket. Each chain requires one male and one female bracket. M6 screws are used to secure the brackets in place. Extrusion-coated metal bushes with either a through-hole (-FB) or a threaded hole (-FG) ensure the permanent, high-strength transmission of even extreme forces onto the cable drag chain.

Type	Order No.	Material	Version	Inside width							Outside width of KA 0 inch	
				A inch	E inch	F inch	F1 inch	G inch	G1 inch	H inch		H0 inch
KA 41.1-FB	0411000054	Plastic	with bush	1.77 – 21.50	A+0.79	0.89	0.87	3.11	4.72		0.26	A+1.34
KA 41.1-FG	0411000055	Plastic	with thread	1.77 – 21.50	A+0.79	0.89	0.87	3.11	4.72	M6		A+1.34

KA 41 0 CHAIN BRACKET ANGLE

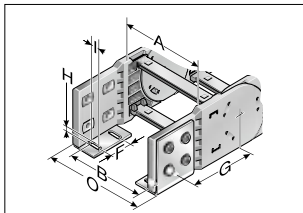

KA 41 (inside top / bottom)

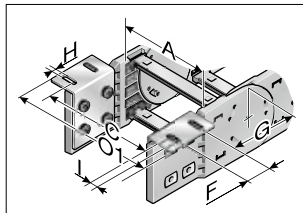

KA 41 (outside top / bottom)

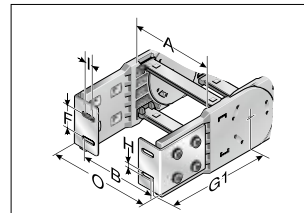

KA 41 (front inside)

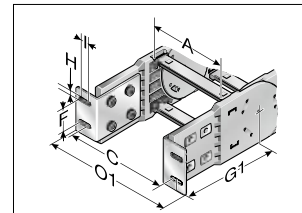

KA 41 (front outside)

There are several options regarding the chain bracket. The fixed-point bracket (inside/bottom) and the moving end bracket (inside/top) are supplied as standard. However, any other combination can be supplied upon request. The chain bracket is fas-

tened at the end like a side link. This enables the chain to move right up to the bracket. Each chain requires two chain brackets. The brackets should be fastened with M6 screws.

Type	Order No.	Material	Inside width							Outside width of KA 0	Outside width of KA 01
			A inch	B inch	C inch	F inch	G inch	G1 inch	HØ inch		
KA 41	0410000051	Sheet steel	1.77 – 21.50	A-0.10	A+1.36	1.26	3.11	4.95	0.26	A+1.26	A+2.80

GS 41.2 SLIDING BLOCK

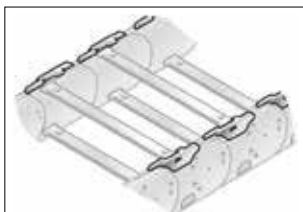

Sliding block

In the case of cable drag chains, sliding blocks are used in a horizontally sliding installation mode (the tight side of the chain slides on the slack side). The sliding blocks are set onto the side links on the interior bend instead of the usual crossbar interlocks; (no tools needed). This forces the chain to slide on the sliding blocks instead on the side links of the chain. Depending on the application, the service life of the cable drag chain may be extended five-fold, by using slide blocks. Information about the minimum bending radius of the cable drag chain at the sliding block insert is listed in the following table.

Type	Order No.	Min. radius inch	Sliding block height inch
GS 41.2	041290400300	4.72	0.16

GLP 4 (41.2) GLIDING PLATE

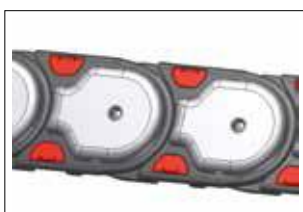

Gliding plate

The gliding plates are mounted in a horizontal position, with the chain laying on its side, to minimize friction wear to the sides. They are mounted to the side links using a special screw. The wear limit is 0.1 in (2.5 mm). We recommend replacing the cable drag chain when this limit has been reached. Depending on the application, the service life of the cable drag chain may be extended two-fold, by using gliding plates. The cable drag chain must be placed on its side before opening.

Type	Order No.	Installation site	for radius inch	Gliding plate height inch
SG 41.2 RK090 with GLP4, mounted	041200009064	Chain link including gliding plate	3.54	0.28
SG 41.2 RK120 with GLP4, mounted	041200012064	Chain link including gliding plate	4.72	0.28
SG 41.2 RK150 with GLP4, mounted	041200015064	Chain link including gliding plate	5.91	0.28
SG 41.2 RK175 with GLP4, mounted	041200017564	Chain link including gliding plate	6.89	0.28
SG 41.2 RK200 with GLP4, mounted	041200020064	Chain link including gliding plate	7.87	0.28
SG 41.2 RK250 with GLP4, mounted	041200025064	Chain link including gliding plate	9.84	0.28
SG 41.2 RK300 with GLP4, mounted	041200030064	Chain link including gliding plate	11.81	0.28
SG 41.2 RK350 with GLP4, mounted	041200035064	Chain link including gliding plate	13.78	0.28

MP 41 SEPARATOR

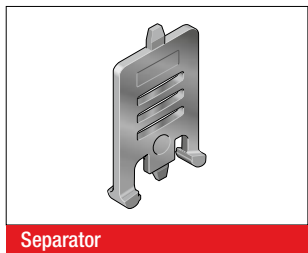
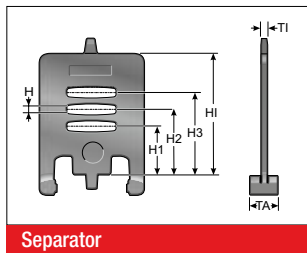

We recommend that separators be used if multiple round cables or conduits with differing diameters are to be installed.

Type	Order No.	Description	Version	TI inch	TA inch	H inch	H1 inch	H2 inch	H3 inch	HI inch
TR 41	041000009200	Separator	lockable	0.14	0.39	0.17	0.63	0.90	1.14	1.65

MP 41.1 SEPARATOR

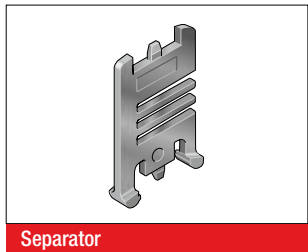
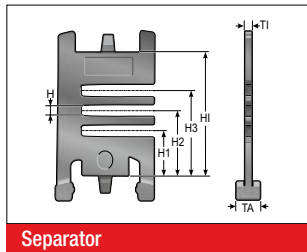

We recommend that separators be used if multiple round cables or conduits with differing diameters are to be installed.

Type	Order No.	Description	Version	TI inch	TA inch	H inch	H1 inch	H2 inch	H3 inch	HI inch
TR 41.1	041200009200	Separator	lockable	0.14	0.31	0.16	0.63	0.90	1.14	1.65

TR 41-V SEPARATOR

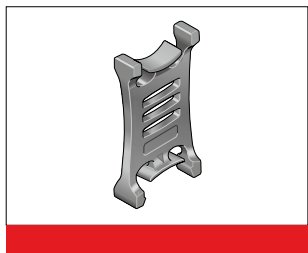
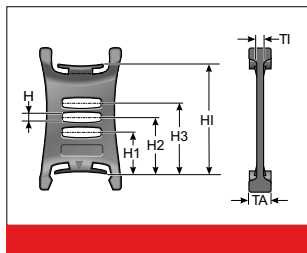

We recommend that separators be used if multiple round cables or conduits with differing diameters are to be installed.

Type	Order No.	Description	Version	TI inch	TA inch	H inch	H1 inch	H2 inch	H3 inch	HI inch
TR 41-V	041000009300	Separator	movable	0.14	0.47	0.16	0.63	0.90	1.14	1.65

RTT 41 SHELF SUPPORT, DIVISIBLE

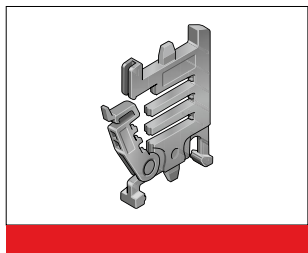
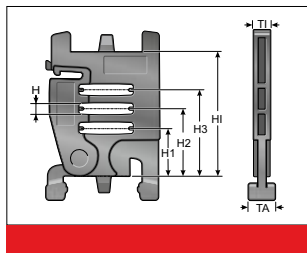

In connection with two separable shelf supports (RTT) with at least one end-to-end shelf (RB) the shelf becomes an easy to fill shelving system. The additional levels prevent cables from criss-crossing and minimize the friction between them.

Type	Order No.	Description	Version	TI inch	TA inch	H inch	H1 inch	H2 inch	H3 inch	HI inch
RTT 41	100090412000	Shelf support, divisible	lockable	0.28	0.31	0.16	0.63	0.90	1.14	1.65

RB-5 SHELF

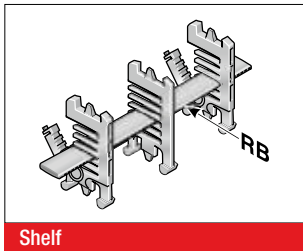

In connection with at least two separable shelf supports (RTT), the shelf becomes a shelving system. The additional levels prevent cables from criss-crossing and minimize the friction between them.

Type	Order No.	Description	Width inch	Inside width inch
RB 028-5	100000002800	Shelf	1.10	1.77
RB 034-5	1000003405	Shelf	1.32	1.77
RB 039-5	1000003905	Shelf	1.54	1.77
RB 045-5	1000004505	Shelf	1.76	2.24
RB 050-5	1000005005	Shelf	1.98	2.24
RB 056-5	100000005601	Shelf	2.20	2.44
RB 062-5	1000006205	Shelf	2.43	2.44
RB 067-5	1000006705	Shelf	2.65	3.31
RB 073-5	1000007305	Shelf	2.87	3.31
RB 078-5	1000007805	Shelf	3.09	3.31
RB 084-5	100000008400	Shelf	3.31	3.31
RB 090-5	1000009005	Shelf	3.53	3.78
RB 095-5	1000009505	Shelf	3.75	3.78
RB 101-5	1000010105	Shelf	3.97	4.21
RB 106-5	1000010605	Shelf	4.19	4.21
RB 112-5	100000011200	Shelf	4.41	4.76
RB 118-5	1000011805	Shelf	4.63	4.76
RB 123-5	1000012305	Shelf	4.85	5.24
RB 129-5	1000012905	Shelf	5.07	5.24
RB 134-5	1000013405	Shelf	5.29	5.67
RB 140-5	100000014000	Shelf	5.51	5.67
RB 146-5	1000014605	Shelf	5.73	6.22
RB 151-5	1000015105	Shelf	5.95	6.22
RB 157-5	1000015705	Shelf	6.17	6.46
RB 162-5	1000016205	Shelf	6.39	6.46
RB 168-5	100000016800	Shelf	6.61	7.17
RB 174-5	1000017405	Shelf	6.83	7.17
RB 179-5	1000017905	Shelf	7.06	7.72
RB 185-5	1000018505	Shelf	7.28	7.72
RB 190-5	1000019005	Shelf	7.50	7.72
RB 196-5	100000019600	Shelf	7.72	7.72
RB 291-5	100000029100	Shelf	11.46	13.62

MP 41 CROSSBAR CONNECTOR

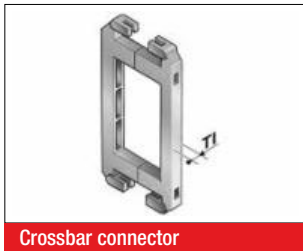

For crossbars wider than 9.69 inch (246 mm), we recommend the use of crossbar connectors. These prevent deformation to the crossbar under large amounts of additional weight of the chain assembly.

Type	Order No.	Description	TI inch
RSV 41	041000009600	Crossbar connector	0.30
RSV 41 Alu	041000009800	Crossbar connector for aluminum crossbars	0.30

MP 41 H-SHAPED SHELF UNIT

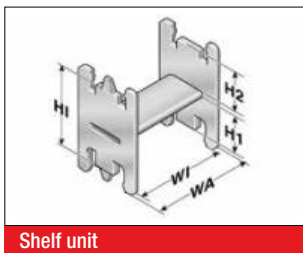

One-piece shelving system, the shelf cannot be varied in height.

Type	Order No.	Description	WA inch	WI inch	H1 inch	H2 inch	HI inch
RE 36/11	100000361112	H-shaped shelf unit	1.67	1.44	1.03	0.45	1.65
RE 59/18	100000591812	H-shaped shelf unit	2.56	2.32	0.74	0.74	1.65
RE 81/11	100000811112	H-shaped shelf unit	3.44	3.21	1.03	0.45	1.65

BS-5 BRACKET BAR



Large-diameter conduits are routed securely by using bracket bars (BS). This bar is installed on the crossbars or the covers of the cable drag chain. The bracket bar can be installed on both the inside and outside bend.

The bracket bar support (BSH) is used to attach the bars to PowerLine series crossbars. Two bracket bar supports are required for each bar.

Type	Order No.	Description	Conduit diameter max. inch	Installation height inch	Inner chain width min. inch
BS 120-5	052412000000	Bracket bar	4.53	5.51	6.46
BS 153-5	052415300000	Bracket bar	5.83	6.69	8.19
BS 187-5	052418700000	Bracket bar	7.17	8.07	9.17
BSH-5	052400000000	Bracket bar support			
Assembly set	052400000001	Assembly set			

D4 CHAIN BRACKET COVER

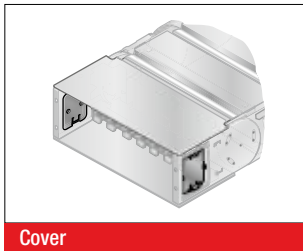

Self-locking covers close the side mounting window on the flexible chain bracket (KA-FB/FG).

Type	Order No.
D4 Cover	0413888002

MP 41.3 CHAIN BRACKET CANOPY

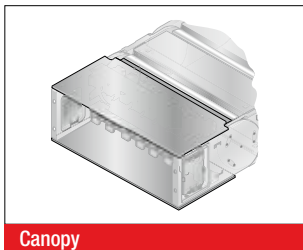

Constructed from aluminum, the canopies for the flexible chain bracket (KA-FB/FG) ensure a continuously closed system for chains with covers.

Canopy for chain bracket, fixed point outside bend: Type and Order No. configurator



Type:	KA 41.1 FB/FG AB	Inside width	2-2
Order No.:	0411	Inside width	060

Canopy for chain bracket, fixed point inside bend: Type and Order No. configurator

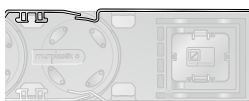

Type:	KA 41.1 FB/FG IB	Inside width	2-2
Order No.:	0411	Inside width	058

Canopy for chain bracket, moving end outside bend: Type and Order No. configurator

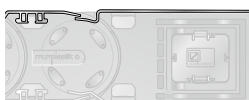

Type:	KA 41.1 FB/FG AB	Inside width	1-2
Order No.:	0411	Inside width	059

Canopy for chain bracket, moving end inside bend: Type and Order No. configurator



Type:	KA 41.1 FB/FG IB	Inside width	1-2
Order No.:	0411	Inside width	057

Ordering example:

0411096058 KA 41.1 FB/FG IB 096 2-2

Chain bracket canopy at fixing point in inside bend, for inside width of 3.78 in. (96 mm).

RS-ZL-5 CROSSBAR STRAIN RELIEF PLATE

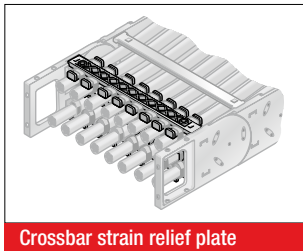

Fixed integrated crossbar strain relief plates in the chain brackets. Tailored to all crossbar widths up to 9.69 inch (246 mm). May be assembled on the inside and outside bends at both chain endings.

Type	Order No.	Description	Inside width inch
RS-ZL 045-5	052004500010	Crossbar strain relief plate	1.77
RS-ZL 057-5	052005700010	Crossbar strain relief plate	2.24
RS-ZL 062-5	052006200010	Crossbar strain relief plate	2.44
RS-ZL 071-5	052007100010	Crossbar strain relief plate	2.80
RS-ZL 084-5	052008400010	Crossbar strain relief plate	3.31
RS-ZL 093-5	052009300010	Crossbar strain relief plate	3.66
RS-ZL 096-5	052009600010	Crossbar strain relief plate	3.78
RS-ZL 104-5	052010400010	Crossbar strain relief plate	4.09
RS-ZL 107-5	052010700010	Crossbar strain relief plate	4.21
RS-ZL 121-5	052012100010	Crossbar strain relief plate	4.76
RS-ZL 133-5	052013300010	Crossbar strain relief plate	5.24
RS-ZL 144-5	052014400010	Crossbar strain relief plate	5.67
RS-ZL 146-5	052014600010	Crossbar strain relief plate	5.75
RS-ZL 158-5	052015800010	Crossbar strain relief plate	6.22
RS-ZL 164-5	052016400010	Crossbar strain relief plate	6.46
RS-ZL 171-5	052017100010	Crossbar strain relief plate	6.73
RS-ZL 182-5	052018200010	Crossbar strain relief plate	7.17
RS-ZL 196-5	052019600010	Crossbar strain relief plate	7.72
RS-ZL 208-5	052020800010	Crossbar strain relief plate	8.19
RS-ZL 220-5	052022000010	Crossbar strain relief plate	8.66
RS-ZL 233-5	052023300010	Crossbar strain relief plate	9.17
RS-ZL 246-5	052024600010	Crossbar strain relief plate	9.69

MP 32/41 LOCK BUTTON

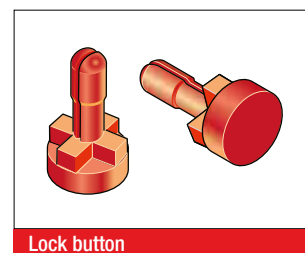
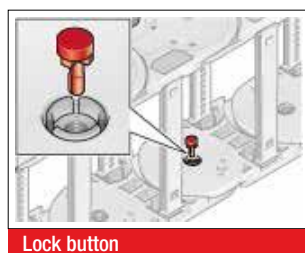
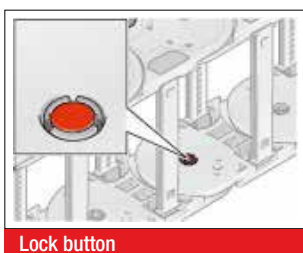

To increase the side stability we recommend the use of lock buttons during strong lateral acceleration or when installed “laying

on the side (turned 90°) without support”.

Type	Order No.
MP32/41 lock button	04100008000

STRAIN RELIEF WITH STEEL FIX

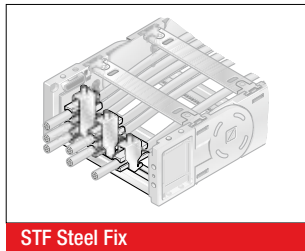
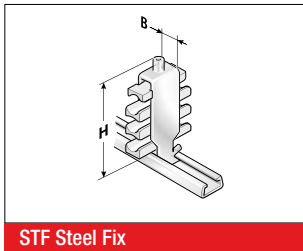

C-rails (galvanized) for permanent integration, for accommodating the Steel Fix bow clamps in the chain brackets. The bow clamps can take up to 3 cables and are suitable for C-rails with a groove width of 0.43 in (11 mm). Due to the design of the trough elements, a cable preserving cable guidance is ensured. May be assembled on the inside and outside bends at both chain endings. The overall height stated is a guide only. The actual height is, amongst other things, dependent on the diameter and the quality of the cable. A safety distance of 0.39 in (10 mm) at the fixed point above the strain relief must be kept during gliding applications.

Type	Order No.	Description	Seats qty.	Cable Ø inch	Width (B) inch	Total height (H) inch
Single clamp (for one cable)						
STF 12-1 Steel Fix	81661801	Hooped clamp	1	0.24 – 0.47	0.63	2.17
STF 14-1 Steel Fix	81661802	Hooped clamp	1	0.47 – 0.55	0.71	2.05
STF 16-1 Steel Fix	81661803	Hooped clamp	1	0.55 – 0.63	0.79	2.13
STF 18-1 Steel Fix	81661804	Hooped clamp	1	0.63 – 0.71	0.87	2.20
STF 20-1 Steel Fix	81661805	Hooped clamp	1	0.71 – 0.79	0.94	2.32
STF 22-1 Steel Fix	81661806	Hooped clamp	1	0.79 – 0.87	1.02	2.40
STF 26-1 Steel Fix	81661807	Hooped clamp	1	0.87 – 1.02	1.18	2.76
STF 30-1 Steel Fix	81661808	Hooped clamp	1	1.02 – 1.18	1.34	2.91
STF 34-1 Steel Fix	81661809	Hooped clamp	1	1.18 – 1.34	1.50	3.07
STF 38-1 Steel Fix	81661810	Hooped clamp	1	1.34 – 1.50	1.65	3.23
STF 42-1 Steel Fix	81661811	Hooped clamp	1	1.50 – 1.65	1.81	3.58
Double clamp (for two cables)						
STF 12-2 Steel Fix	81661821	Hooped clamp	2	0.24 – 0.47	0.63	2.87
STF 14-2 Steel Fix	81661822	Hooped clamp	2	0.47 – 0.55	0.71	2.91
STF 16-2 Steel Fix	81661823	Hooped clamp	2	0.55 – 0.63	0.79	3.23
STF 18-2 Steel Fix	81661824	Hooped clamp	2	0.63 – 0.71	0.87	3.39
STF 20-2 Steel Fix	81661825	Hooped clamp	2	0.71 – 0.79	0.94	3.58
STF 22-2 Steel Fix	81661826	Hooped clamp	2	0.79 – 0.87	1.02	3.74
STF 26-2 Steel Fix	81661827	Hooped clamp	2	0.87 – 1.02	1.18	4.25
STF 30-2 Steel Fix	81661828	Hooped clamp	2	1.02 – 1.18	1.34	4.76
STF 34-2 Steel Fix	81661829	Hooped clamp	2	1.18 – 1.34	1.50	5.08
Triple clamp (for three cables)						
STF 12-3 Steel Fix	81661841	Hooped clamp	3	0.24 – 0.47	0.63	3.86
STF 14-3 Steel Fix	81661842	Hooped clamp	3	0.47 – 0.55	0.71	3.86
STF 16-3 Steel Fix	81661843	Hooped clamp	3	0.55 – 0.63	0.79	4.13
STF 18-3 Steel Fix	81661844	Hooped clamp	3	0.63 – 0.71	0.87	4.37
STF 20-3 Steel Fix	81661845	Hooped clamp	3	0.71 – 0.79	0.94	4.65
STF 22-3 Steel Fix	81661846	Hooped clamp	3	0.79 – 0.87	1.02	5.12

LOWERED FIXING POINT MP 41

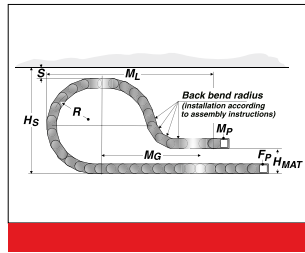
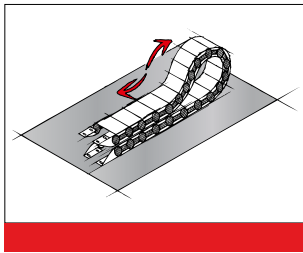

It is sometimes necessary to lower the height of the moving attachment point. In such cases, modifications to the chain layout should be noted (e.g. extension of chain). Please contact our application engineers.

Radius R inch	Height of moving end connection (H_{MA}) inch	Safety margin (S) inch	Installation height incl. safety ($\psi(S)$) inch	Projection (M_L) inch	Additional links qty.	of which additional back chain links qty.
6.89	6.30	1.97	18.58	25.20	6	2
7.87	7.48	1.97	20.55	30.31	13	2
9.84	8.66	1.97	24.49	35.83	15	2
11.81	11.02	1.97	28.43	46.46	19	2
13.78	12.60	1.97	32.36	44.88	19	3

MP 41.2 REARWARD RADII

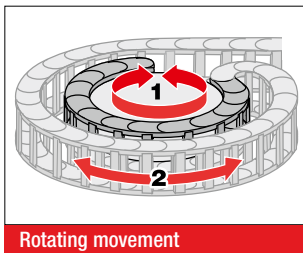

Rotating movement

Side links with forward radius (R) and rearward radius (Rü) allow movements in both directions. This is intended for rotating movements and lowered chain brackets. Rotation movements are only possible with open variants.

Type	Order No.	Radius inch	Back radius inch
SR 41.2 (RÜ200/R125)	041200009060	4.92	7.87
SR 41.2 (RÜ200/R160)	041200012060	6.30	7.87
SR 41.2 (RÜ200/R175)	041200015060	6.89	7.87
SR 41.2 (RÜ200/R200)	041200020060	7.87	7.87
SR 41.2 (RÜ200/R250)	041200025060	9.84	7.87
SR 41.2 (RÜ200/R300)	041200030060	11.81	7.87
SR 41.2 (RÜ200/R350)	041200035060	13.78	7.87

GUIDE CHANNEL VAW (ALUMINUM / STAINLESS STEEL)



VAW steel galvanized / stainless steel



VAW aluminum

A range of variable guide channel systems, constructed from aluminum or stainless steel sections, is available for this cable drag chain. The variable guide channel ensures that the cable drag chain is supported and guided securely.

ASSEMBLY INSTRUCTION FLEXIBLE CHAIN BRACKET FB/FG

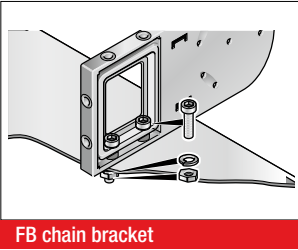

FB chain bracket

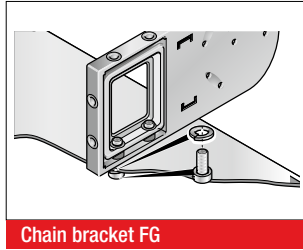

Chain bracket FG

Brass bushes guarantee long-lasting fastening without cold flow in the plastic.

Version KA-FB:

Integrated through-hole fastened down using nut and bolt.

Version KA-FG:

Built-in threads allow for quick and easy on-site mounting, since a screw, including a retaining washer where necessary, is sufficient.

ASSEMBLY

DISASSEMBLY

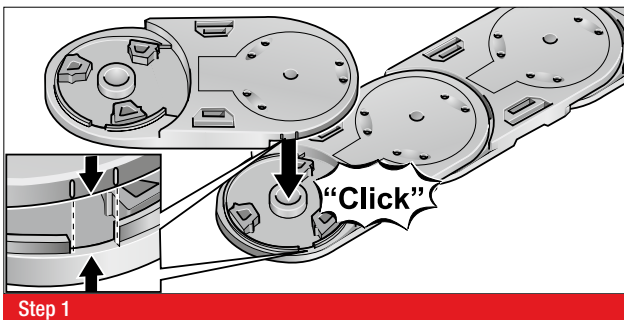

Step 1

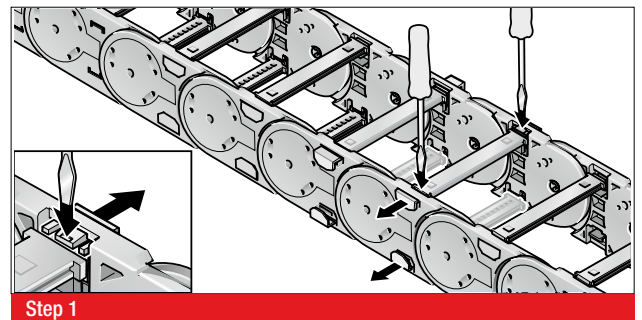

Step 1

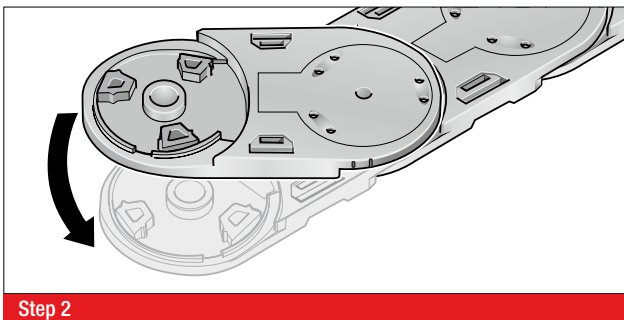

Step 2

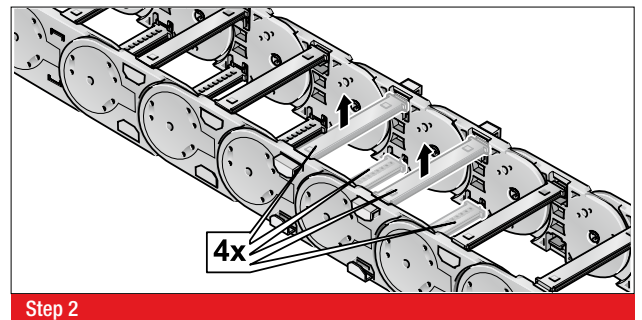

Step 2

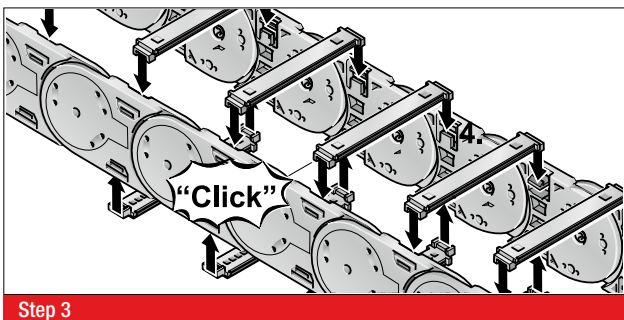

Step 3

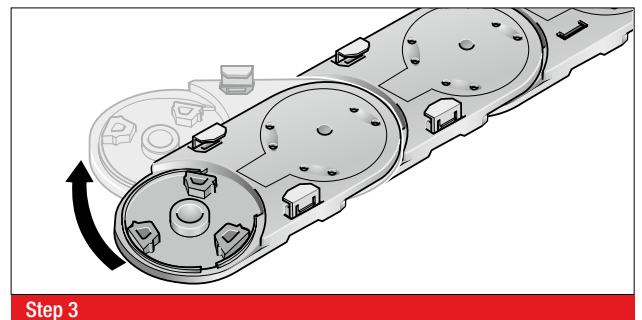

Step 3

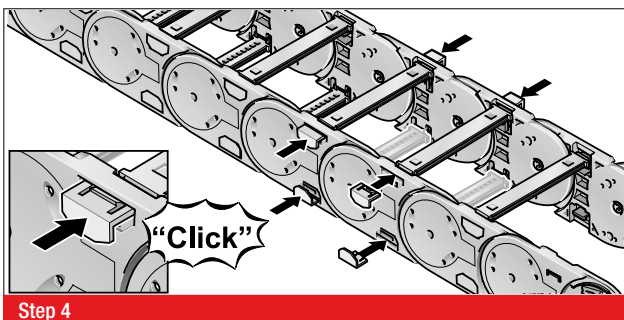

Step 4

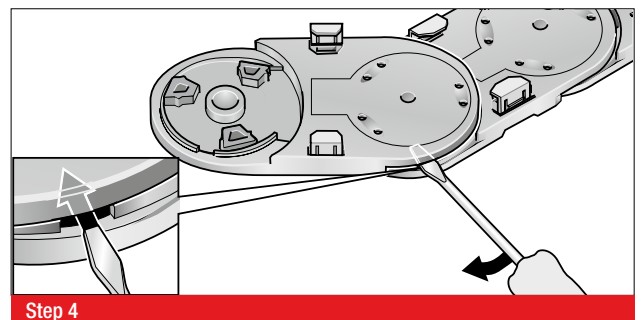

Step 4

MP 52.2 OPEN



MP 52.3 CLOSED



- SLIDING BLOCKS FOR LONGER SERVICE LIFE
- BROAD INTERIOR LAYOUT
- CHAIN BRACKET FLEXIBLE
- PLASTIC OR ALUMINUM VERSION

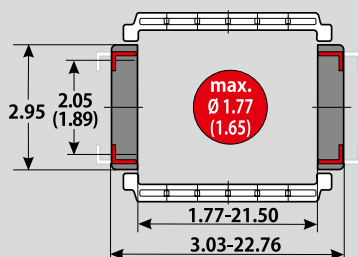

TECHNICAL DATA

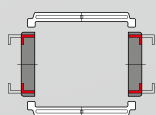

Loading side
Inside and outside bend

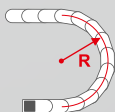

Available radii
3.94 – 13.78 inch

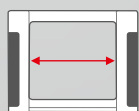

Available interior widths
With plastic crossbar
1.77 – 21.5 inch
With aluminum crossbar / cover
2.64 – 23.62 inch / 1.69 – 23.62 inch

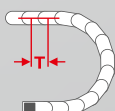

Grid
T = 3.58 inch

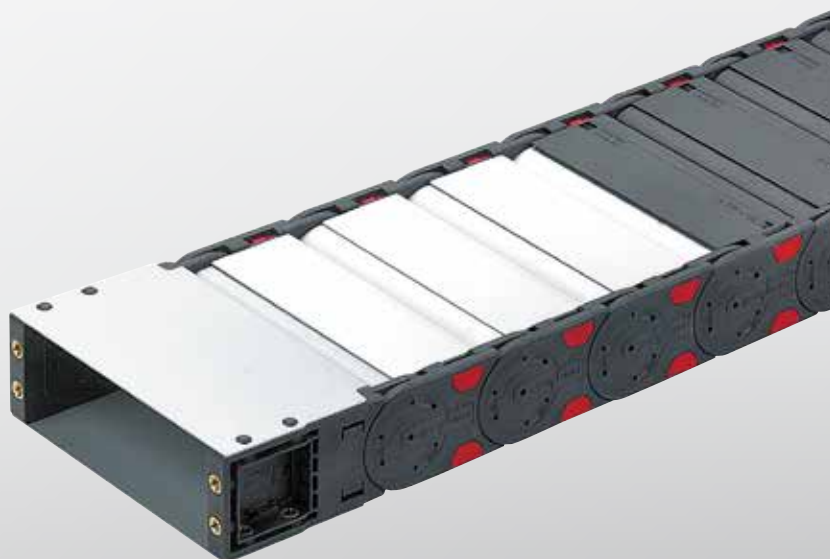

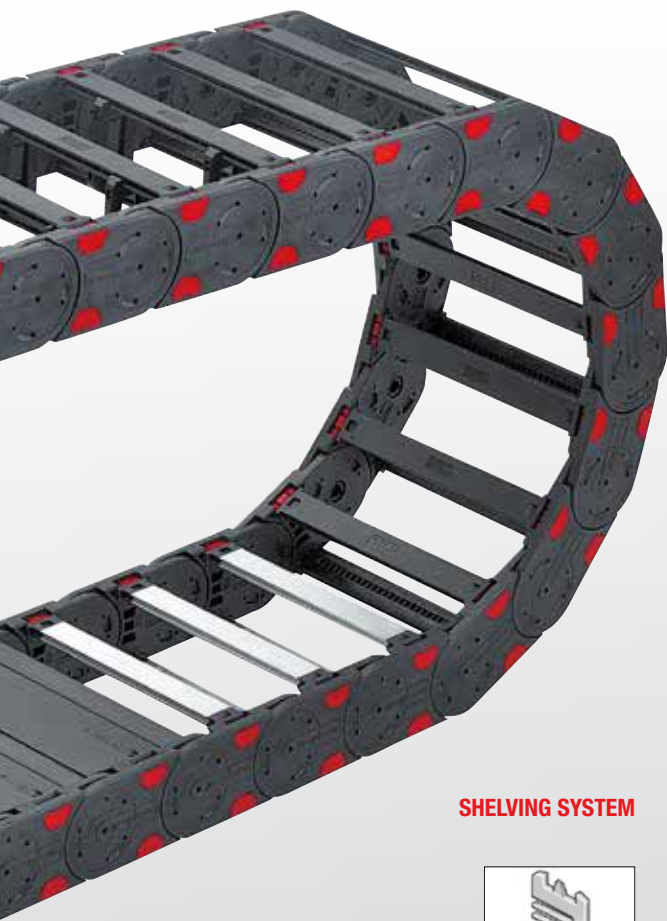

TECHNICAL SPECIFICATIONS

Travel distance gliding L_g max.	492.13 ft.
Travel distance self-supporting L_s max.	see diagram on page 221
Travel distance vertical, hanging L_{vh} max.	196.85 ft.
Travel distance vertical, upright L_{vs} max.	19.69 ft.
Rotated 90°, unsupported L_{90f} max.	6.56 ft.
Speed, gliding V_g max.	16.40 ft/s
Speed, self-supporting V_f max.	65.62 ft/s
Acceleration, gliding a_g max.	82.02 ft/s ²
Acceleration, self-supporting a_s max.	98.43 ft/s ²

Contact our engineering department to meet any higher requirements: efk@murrplastik.de

MATERIAL PROPERTIES

Standard material	Polyamide (PA) black
Service temperature	-22.00 – 248.00 °F
Gliding friction factor	0.30
Static friction factor	0.45
Fire classification	UL 94 HB

Other material properties on request

ACCESSORIES

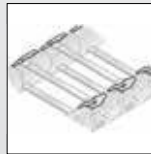

Sliding block

SHELVING SYSTEM



Separator TR

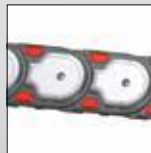

Gliding plate

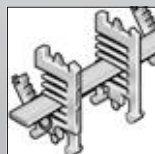

RS shelving system



Bracket bar

CHAIN BRACKET

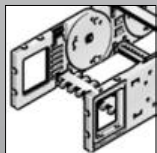

Chain bracket flexible



Crossbar connector RSV



Cover

GUIDE CHANNELS



VAW steel galvanized / stainless steel



RS-ZL crossbar strain relief

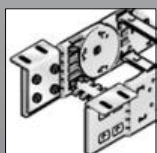

Chain bracket angle

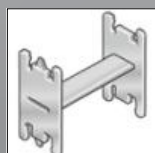

H-shaped shelf unit RE

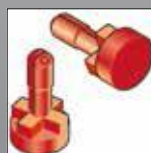

Lock button

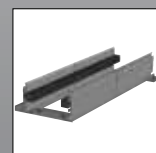

VAW aluminum

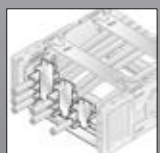

STF Steel Fix

ORDERING KEY

Dimensions in mm [US inch]

Type code	Variation	Inside width	Outside width	Inside width	Outside width	Radius	Rail variant	Material	Chain length
0522 30	MP 52.2 open Crossbar on outside bend Crossbar on inside bend Opens on inside and outside of bend	045 ¹⁾ [1.77]	077 [3.03]	233 [9.17]	265 [10.43]	100 ¹⁾ [3.94]	0 Plastic, full-ridged with bias	0 Polyamide (PA): standard (PA/black)	
		057 ¹⁾ [2.24]	089 [3.50]	246 ²⁾ [9.69]	278 ²⁾ [10.94]				
0523 44 ³⁾	MP 52.3 closed Cover on outside of bend Cover on inside of bend Opens on inside and outside of bend	062 ¹⁾ [2.44]	094 [3.70]	252 [9.92]	284 [11.18]	150 [5.91]	1 Plastic, full-ridged without bias	5 Polypropylene (PP/blue)	
		071 [2.80]	103 [4.06]	258 [10.16]	290 [11.42]				
		084 [3.31]	116 [4.57]	296 ²⁾ [11.65]	328 ²⁾ [12.91]	175 [6.89]	2 Plastic, half-ridged with bias	7 ESD (PA/light gray)	
		093 [3.66]	125 [4.92]	346 ²⁾ [13.62]	378 ²⁾ [14.88]				
		096 ²⁾ [3.78]	128 ²⁾ [5.04]	350 [13.78]	382 [15.04]	200 [7.87]	3 Plastic, half-ridged without bias	9 Special version (on request)	
		104 [4.09]	136 [5.35]	358 [14.09]	390 [15.35]				
		107 [4.21]	139 [5.47]	371 [14.61]	403 [15.87]	250 [9.84]	4 Aluminum full-ridged with bias		
		121 ²⁾ [4.76]	153 ²⁾ [6.02]	396 [15.59]	428 [16.85]				
		133 [5.24]	165 [6.50]	421 [16.57]	453 [17.83]	300 [11.81]	5 Aluminum full-ridged without bias		
		144 [5.67]	176 [6.93]	446 [17.56]	478 [18.82]				
		146 ²⁾ [5.75]	178 ²⁾ [7.01]	496 [19.53]	528 [20.79]	350 [13.78]	6 Aluminum half-ridged with bias		
		158 [6.22]	190 [7.48]	546 [21.50]	578 [22.76]				
		164 [6.46]	196 [7.72]				7 Aluminum half-ridged without bias		
		171 [6.73]	203 [7.99]						
		182 ²⁾ [7.17]	214 ²⁾ [8.43]				9 Special version (on request)		
		196 ²⁾ [7.72]	228 ²⁾ [8.98]						
		208 [8.19]	240 [9.45]						
		220 ²⁾ [8.66]	252 ²⁾ [9.92]						

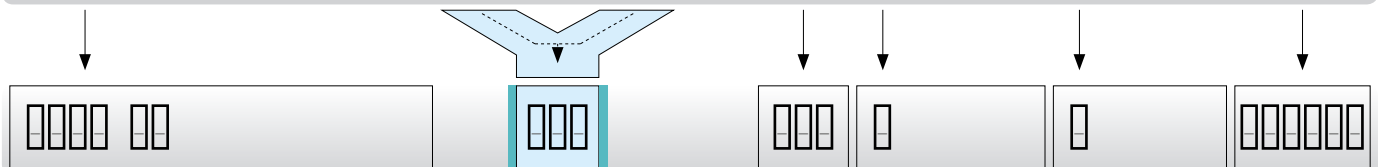

ORDERING EXAMPLE: 0522 30 220 100 0 0 1365

Crossbar on outside bend, crossbar on inside bend, can be opened from inside and outside bend
 Inside width 8.66 in. (220 mm), radius 3.94 in. (100 mm)
 Plastic crossbar, full-ridged with bias, material black-colored polyamide
 Chain length 53.74 in. (1365 mm) (15 links)

- ¹⁾ for Variant 30 only
- ²⁾ also available with plastic cover
- ³⁾ reduced inner height, reduced max. cable diameter, see chain window drawing on previous page

NOTE ON CONFIGURATION

Aluminum crossbars:

Aluminum crossbars in 0.04 in (1 mm) width sizes for inner widths from 2.64 inch – 23.62 inch are available for delivery.

Aluminum covers:

Aluminum covers in 0.04 in (1 mm) width sizes for inner widths from 1.69 inch – 23.62 inch are available for delivery.

Crossbar connector and crossbar strain relief plate:

Once inside widths exceed 9.69 inch, we recommend the deployment of crossbar connectors (RSV).

Crossbar connectors cannot be used in conjunction with covers made from plastic or aluminum.

If crossbar strain relief plates (RS-ZL) are to be deployed in the chain brackets, take standard inside widths into account.

For detailed information, please consult the corresponding product documentation.

SELF-SUPPORTING LENGTH

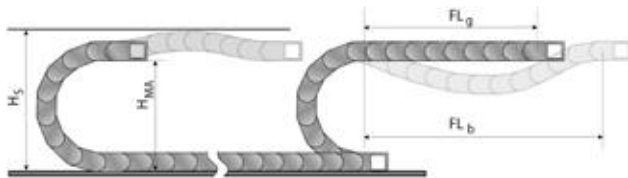

The self-supporting length is the distance between the chain bracket on the moving end and the start of the chain arch. The installation variant FL_g offers the lowest load and wear for the cable drag chain.

The maximum travel parameters (speed and acceleration) can be applied for this variant.

- H_S = Installation height plus safety
- H_{MA} = Height of moving end connection
- FL_g = Self-supporting length, upper run straight
- FL_b = Self-supporting length, upper run bent

LOAD DIAGRAM FOR SELF-SUPPORTING APPLICATIONS

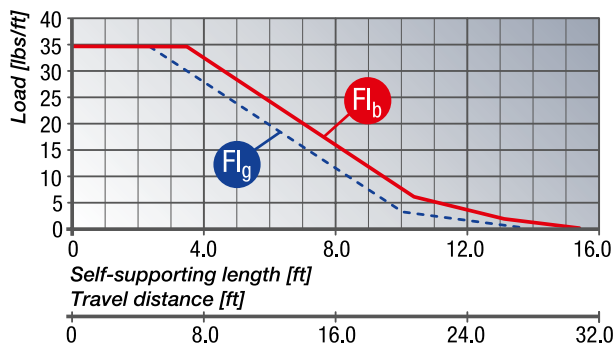

FL_g Self-supporting length, upper run straight

In the FL_g range, the chain upper run still has a bias, is straight or has a maximum sag of 2.76 inch.

FL_b Self-supporting length, upper run bent

In the FL_b range, the chain upper run has a sag of more than 2.76 inch, but this is still less than the maximum sag.

Where the sag is greater than that permitted in the FL_b range, the application is critical and should be avoided. The self-supporting length can be optimized by using a support for the upper run or a more stable cable drag chain.

Closed cable drag chains (with covers) have a higher unit weight than open chains (with crossbars). This higher weight must be taken into account when calculating the self-supporting length. To the weight of the cabling (cable load, in lbs/ft (kg/m)), you must add 1.00 lbs/ft (1.5 kg/m), to account for the higher weight of closed-cover chains.

DETERMINING THE CHAIN LENGTH

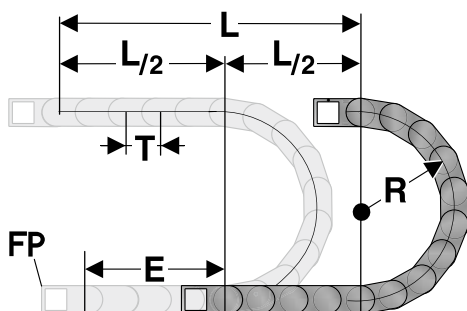

The fixed point of the cable drag chain should be connected in the middle of the travel distance.

This arrangement gives the shortest connection between the fixed point (FP) and the moving bracket and thus the most efficient chain length.

Chain length calculation = $L/2 + \pi * R + E$
 $\approx 1 \text{ ft chain} = 4 \text{ qty.} \times 3.58 \text{ inch.}$

- E = Distance between entry point and middle of travel distance
- L = Travel distance
- R = Radius
- P = Grid 3.58 inch

INSTALLATION DIMENSIONS

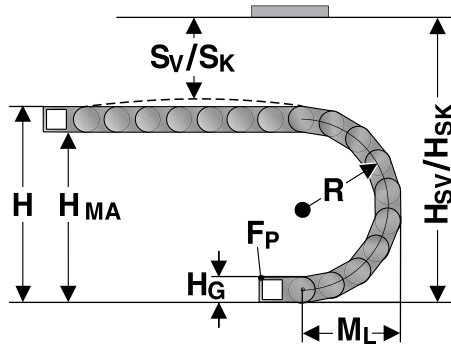

The moving end chain connection is to be screw fixed at height H_{MA} for the respective radius.
 Concerning the installed dimensions, you must take into account whether the chain links are equipped with or without bias. For chain links without bias, the “Installed height without bias H_{SK} ” value has to be taken into account.
 If the chain links are equipped with a bias, the value “Installed height with bias H_{SV} ” has to be taken into account.

Radius R	3.94	5.91	6.89	7.87	9.84	11.81	13.78
Outside height of chain link (H_G)	2.95	2.95	2.95	2.95	2.95	2.95	2.95
Height of bend (H)	12.01	15.95	17.91	19.87	23.81	27.75	31.69
Height of moving end connection (H_{MA})	9.06	13.00	14.96	16.92	20.86	24.80	28.74
Safety margin with bias (S_V)	1.81	1.81	1.81	1.81	1.81	1.81	1.81
Installation height with bias (H_{SV})	13.82	17.76	19.72	21.68	25.62	29.56	33.50
Safety margin without bias (S_K)	0.63	0.63	0.63	0.63	0.63	0.63	0.63
Installation height without bias (H_{SK})	12.64	16.58	18.54	20.50	24.44	28.38	32.32
Arc projection (M_L)	9.59	11.56	12.54	13.52	15.49	17.45	19.42

POWERLINE PLASTIC CROSSBAR



Crossbar

The crossbars connect the two side runs of the cable drag chain. The crossbar length is synonymous with the inside width of the cable drag chain.

Type	Order No.	Description	Inside width inch
BS 045-5	052004500000	Crossbar	1.77
BS 057-5	052005700000	Crossbar	2.24
BS 062-5	052006200000	Crossbar	2.44
BS 071-5	052007100000	Crossbar	2.80
BS 084-5	052008400000	Crossbar	3.31
BS 093-5	052009300000	Crossbar	3.66
BS 096-5	052009600000	Crossbar	3.78
BS 104-5	052010400000	Crossbar	4.09
BS 107-5	052010700000	Crossbar	4.21
BS 121-5	052012100000	Crossbar	4.76
BS 133-5	052013300000	Crossbar	5.24
BS 144-5	052014400000	Crossbar	5.67
BS 146-5	052014600000	Crossbar	5.75
BS 158-5	052015800000	Crossbar	6.22
BS 164-5	052016400000	Crossbar	6.46
BS 171-5	052017100000	Crossbar	6.73
BS 182-5	052018200000	Crossbar	7.17
BS 196-5	052019600000	Crossbar	7.72

POWERLINE PLASTIC CROSSBAR

Type	Order No.	Description	Inside width inch
BS 208-5	052020800000	Crossbar	8.19
BS 220-5	052022000000	Crossbar	8.66
BS 233-5	052023300000	Crossbar	9.17
BS 246-5	052024600000	Crossbar	9.69
BS 252-5	052025200010	Crossbar	9.92
BS 258-5	052025800000	Crossbar	10.16
BS 296-5	052029600000	Crossbar	11.65
BS 346-5	052034600000	Crossbar	13.62
BS 350-5	052035000000	Crossbar	13.78
BS 358-5	052035800000	Crossbar	14.09
BS 371-5	052037100000	Crossbar	14.61
BS 396-5	052039600000	Crossbar	15.59
BS 421-5	052042100000	Crossbar	16.57
BS 446-5	052044600000	Crossbar	17.56
BS 496-5	052049600000	Crossbar	19.53
BS 546-5	052054600000	Crossbar	21.50

MP 52.3 / MP 52.5 PLASTIC COVER



Cover

The covers connect the two side runs of the cable drag chain. The cover length is synonymous with the inside width of the cable drag chain.

Type	Order No.	Description	Installation site	Inside width inch
A-523062, outside	052306210000	Cover	Outside bend	2.44
I-523062, inside	052306220000	Cover	Inside bend	2.44
A-523096, outside	052309610000	Cover	Outside bend	3.78
I-523096, inside	052309620000	Cover	Inside bend	3.78
A-523121, outside	052312110000	Cover	Outside bend	4.76
I-523121, inside	052312120000	Cover	Inside bend	4.76
A-523146, outside	052314610000	Cover	Outside bend	5.75
I-523146, inside	052314620000	Cover	Inside bend	5.75
A-523182, outside	052318210000	Cover	Outside bend	7.17
I-523182, inside	052318220000	Cover	Inside bend	7.17
A-523196, outside	052319610000	Cover	Outside bend	7.72
I-523196, inside	052319620000	Cover	Inside bend	7.72
A-523220, outside	052322010000	Cover	Outside bend	8.66
I-523220, inside	052322020000	Cover	Inside bend	8.66
A-523246, outside	052324610000	Cover	Outside bend	9.69
I-523246, inside	052324620000	Cover	Inside bend	9.69
A-523296, outside	052329610000	Cover	Outside bend	11.65
I-523296, inside	052329620000	Cover	Inside bend	11.65
A-523346, outside	052334610000	Cover	Outside bend	13.62
I-523346, inside	052334620000	Cover	Inside bend	13.62

KA 52.1 CHAIN BRACKET FLEXIBLE

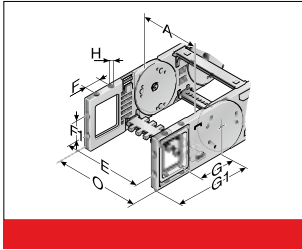

This chain bracket offers universal connection options (top, bottom and front) and is attached to the ends of the chain like a side link. This allows the chain to move right up to the bracket. Each chain requires one male and one female bracket. M8 screws are used to secure the brackets in place. Extrusion-coated metal bushes with either a through-hole (-FB) or a threaded hole (-FG) ensure the permanent, high-strength transmission of even extreme forces onto the cable drag chain.

Type	Order No.	Material	Version	Inside width							Outside width	
				A inch	E inch	F inch	F1 inch	G inch	G1 inch	H inch	H0 inch	of KA O inch
KA 52.1-FB Female end	0521000056	Plastic	with bush	1.77 – 21.50	A+0.63	1.38	1.18	3.50	5.75	0.33		A+1.42
KA 52.1-FB male end	0521000057	Plastic	with bush	1.77 – 21.50	A+0.63	1.38	1.18	3.50	5.75	0.33		A+1.42
KA 52.1-FG female end	0521000058	Plastic	with thread	1.77 – 21.50	A+0.63	1.38	1.18	3.50	5.75	M8		A+1.42
KA 52.1-FG male end	0521000059	Plastic	with thread	1.77 – 21.50	A+0.63	1.38	1.18	3.50	5.75	M8		A+1.42

KA 52.1 CHAIN BRACKET ANGLE

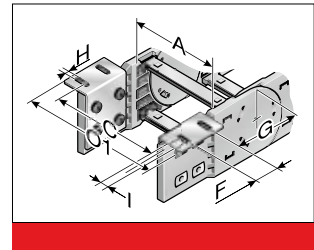
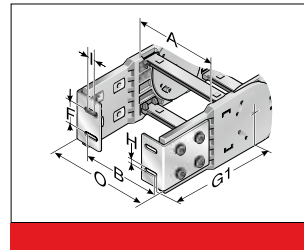
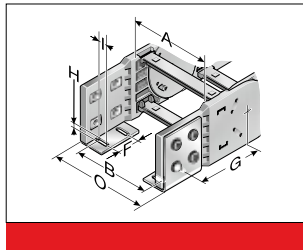
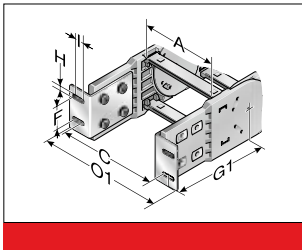

There are several options regarding the chain bracket. The fixed-point bracket (inside/bottom) and the moving end bracket (inside/top) are supplied as standard. However, any other combination can be supplied upon request. The chain bracket

is fastened at the end like a side link. This enables the chain to move right up to the bracket. Each chain requires one male and one female bracket. The brackets should be fastened with M6 screws.

Type	Order No.	Material	Inside width								Outside width of KA O inch	Outside width of KA O1 inch	
			A inch	B inch	C inch	F inch	G inch	G1 inch	H0 inch	I inch			
KA 52.1 Female end	0521000050	Sheet steel	1.77 – 21.50	A-0.10	A+1.36	1.26	3.76	5.67	0.26	0.55		A+1.26	A+2.80
KA 52.1 Male end	0521000051	Sheet steel	1.77 – 21.50	A-0.10	A+1.36	1.26	3.76	5.67	0.26	0.55		A+1.26	A+2.80

GS 52.2 SLIDING BLOCK

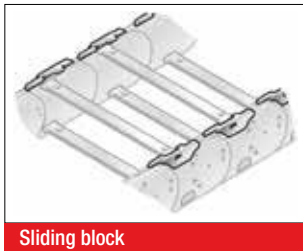

Sliding block

In the case of cable drag chains, sliding blocks are used in a horizontally sliding installation mode (the tight side of the chain slides on the slack side). The sliding blocks are set onto the side links on the interior bend instead of the usual crossbar interlocks; (no tools needed). This forces the chain to slide on the sliding blocks instead on the side links of the chain. Depending on the application, the service life of the cable drag chain may be extended five-fold, by using slide blocks. Information about the minimum bending radius of the cable drag chain at the sliding block insert is listed in the following table.

Type	Order No.	Installation site	Min. radius inch	Sliding block height inch
GS 52.2.1 right	052290400302	For right side link	5.91	0.16
GS 52.2.2 left	052290400300	For left side link	5.91	0.16

GLP 5 (52.2) GLIDING PLATE

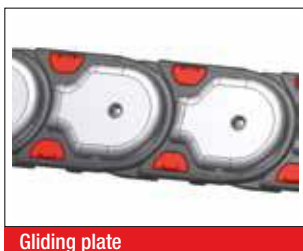

Gliding plate

The gliding plates are mounted in a horizontal position, with the chain laying on its side, to minimize friction wear to the sides. They are mounted to the side links using a special screw. We recommend replacing the cable drag chain when this limit has been reached. Depending on the application, the service life of the cable drag chain may be extended two-fold, by using gliding plates. The cable drag chain must be placed on its side before opening.

Type	Order No.	Installation site	for radius inch	Gliding plate height inch
SG 52.2 RK100.1 right with GLP5, mounted	052200010066	Right chain link including gliding plate	3.94	0.28
SG 52.2 RK100.2 left with GLP5, mounted	052200010064	Left chain link including gliding plate	3.94	0.28
SG 52.2 RK150.1 right with GLP5, mounted	052200015066	Right chain link including gliding plate	5.91	0.28
SG 52.2 RK150.2 left with GLP5, mounted	052200015064	Left chain link including gliding plate	5.91	0.28
SG 52.2 RK175.1 right with GLP5, mounted	052200017566	Right chain link including gliding plate	6.89	0.28
SG 52.2 RK175.2 left with GLP5, mounted	052200017564	Left chain link including gliding plate	6.89	0.28
SG 52.2 RK200.1 right with GLP5, mounted	052200020066	Right chain link including gliding plate	7.87	0.28
SG 52.2 RK200.2 left with GLP5, mounted	052200020064	Left chain link including gliding plate	7.87	0.28
SG 52.2 RK250.1 right with GLP5, mounted	052200025066	Right chain link including gliding plate	9.84	0.28
SG 52.2 RK250.2 left with GLP5, mounted	052200025064	Left chain link including gliding plate	9.84	0.28
SG 52.2 RK300.1 right with GLP5, mounted	052200030066	Right chain link including gliding plate	11.81	0.28
SG 52.2 RK300.2 left with GLP5, mounted	052200030064	Left chain link including gliding plate	11.81	0.28
SG 52.2 RK350.1 right with GLP5, mounted	052200035066	Right chain link including gliding plate	13.78	0.28
SG 52.2 RK350.2 left with GLP5, mounted	052200035064	Left chain link including gliding plate	13.78	0.28

TR 52 SEPARATOR

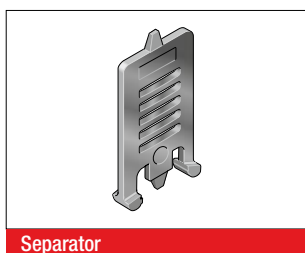
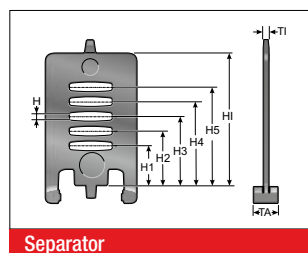

We recommend that separators be used if multiple round cables or conduits with differing diameters are to be installed. The closed separator is used when no shelves are used. This is the recommended design for travel paths of 98.42 ft (30 m) or greater.

Type	Order No.	Description	Version	TI inch	TA inch	H inch	H1 inch	H2 inch	H3 inch	H4 inch	H5 inch	Hl inch
TR 52	052000009200	TR 52 Separator	lockable	0.14	0.39	0.17	0.64	0.88	1.11	1.33	1.57	2.05

TR 52.1 SEPARATOR

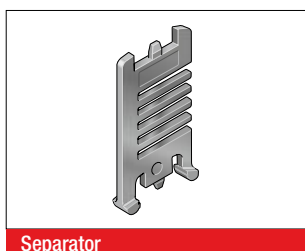
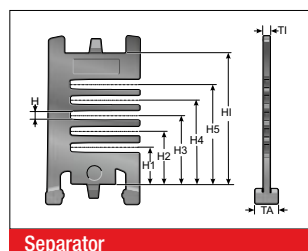

We recommend that separators be used if multiple round cables or conduits with differing diameters are to be installed.

Type	Order No.	Description	Version	TI inch	TA inch	H inch	H1 inch	H2 inch	H3 inch	H4 inch	H5 inch	Hl inch
TR 52.1	052100009200	TR 52.1 Separator	lockable	0.14	0.31	0.16	0.61	0.87	1.11	1.36	1.61	2.05

TR 52-V SEPARATOR

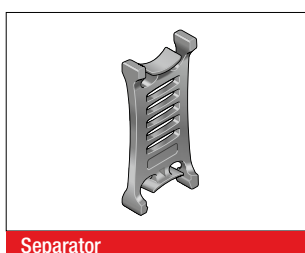
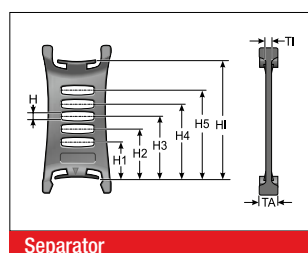

We recommend that separators be used if multiple round cables or conduits with differing diameters are to be installed.

Type	Order No.	Description	Version	TI inch	TA inch	H inch	H1 inch	H2 inch	H3 inch	H4 inch	H5 inch	Hl inch
TR 52-V	052000009300	TR 52-V Separator	movable	0.14	0.51	0.16	0.64	0.88	1.11	1.33	1.57	2.05

RTT 52 SHELF SUPPORT, DIVISIBLE

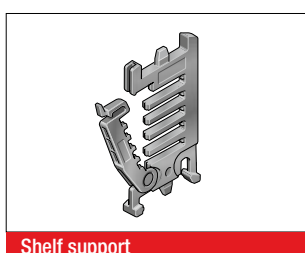
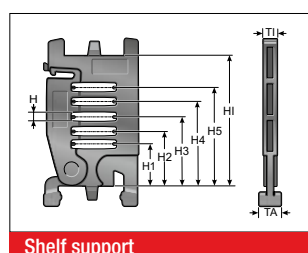

In connection with two separable shelf supports (RTT) with at least one end-to-end shelf (RB) the shelf becomes an easy to fill shelving system. The additional levels prevent cables from criss-crossing and minimize the friction between them.

Type	Order No.	Description	Version	TI inch	TA inch	H inch	H1 inch	H2 inch	H3 inch	H4 inch	H5 inch	Hl inch
RTT 52	100090522000	Shelf support, divisible	lockable	0.28	0.31	0.16	0.61	0.87	1.11	1.36	1.61	2.05

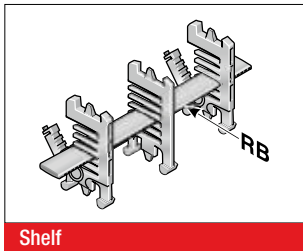
RB-5 SHELF

In connection with at least two separable shelf supports (RTT), the shelf becomes a shelving system. The additional levels prevent cables from criss-crossing and minimize the friction between them.

Type	Order No.	Description	Width inch	Inside width inch
RB 028-5	100000002800	Shelf	1.10	1.77
RB 034-5	1000003405	Shelf	1.32	1.77
RB 039-5	1000003905	Shelf	1.54	1.77
RB 045-5	1000004505	Shelf	1.76	2.24
RB 050-5	1000005005	Shelf	1.98	2.24
RB 056-5	100000005601	Shelf	2.20	2.44
RB 062-5	1000006205	Shelf	2.43	2.44
RB 067-5	1000006705	Shelf	2.65	3.31
RB 073-5	1000007305	Shelf	2.87	3.31
RB 078-5	1000007805	Shelf	3.09	3.31
RB 084-5	100000008400	Shelf	3.31	3.31
RB 090-5	1000009005	Shelf	3.53	3.78
RB 095-5	1000009505	Shelf	3.75	3.78
RB 101-5	1000010105	Shelf	3.97	4.21
RB 106-5	1000010605	Shelf	4.19	4.21
RB 112-5	100000011200	Shelf	4.41	4.76
RB 118-5	1000011805	Shelf	4.63	4.76
RB 123-5	1000012305	Shelf	4.85	5.24
RB 129-5	1000012905	Shelf	5.07	5.24
RB 134-5	1000013405	Shelf	5.29	5.67
RB 140-5	100000014000	Shelf	5.51	5.67
RB 146-5	1000014605	Shelf	5.73	6.22
RB 151-5	1000015105	Shelf	5.95	6.22
RB 157-5	1000015705	Shelf	6.17	6.46
RB 162-5	1000016205	Shelf	6.39	6.46
RB 168-5	100000016800	Shelf	6.61	7.17
RB 174-5	1000017405	Shelf	6.83	7.17
RB 179-5	1000017905	Shelf	7.06	7.72
RB 185-5	1000018505	Shelf	7.28	7.72
RB 190-5	1000019005	Shelf	7.50	7.72
RB 196-5	100000019600	Shelf	7.72	7.72
RB 291-5	100000029100	Shelf	11.46	13.62

RSV 52 CROSSBAR CONNECTOR



For crossbars wider than 9.69 inch (246 mm), we recommend the use of crossbar connectors. These prevent deformation to the crossbar under large amounts of additional weight of the chain assembly.

Type	Order No.	Description	Tl inch
RSV 52	052000009600	Crossbar connector	0.30
RSV 52 Alu	052000009800	Crossbar connector for aluminum crossbars	0.30

RE 52 H-SHAPED SHELF UNIT

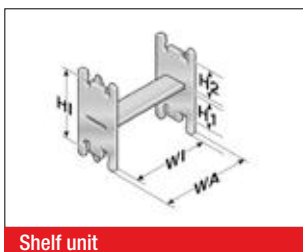

One-piece shelving system, the shelf cannot be varied in height.

Type	Order No.	Description	WA inch	WI inch	H1 inch	H2 inch	H3 inch
RE 36/17	100000361714	H-shaped shelf unit	1.67	1.44	1.22	0.69	2.05
RE 59/24	100000592414	H-shaped shelf unit	2.56	2.32	0.95	0.95	2.05
RE 81/12	100000811214	H-shaped shelf unit	3.44	3.21	1.42	0.49	2.05

BS-5 BRACKET BAR



Large-diameter conduits are routed securely by using bracket bars (BS). This bar is installed on the crossbars or the covers of the cable drag chain. The bracket bar can be installed on both the inside and outside bend.

The bracket bar support (BSH) is used to attach the bars to PowerLine series crossbars. Two bracket bar supports are required for each bar.

Type	Order No.	Description	Conduit diameter max. inch	Installation height inch	Inner chain width min. inch
BS 120-5	052412000000	Bracket bar	4.53	5.51	6.46
BS 153-5	052415300000	Bracket bar	5.83	6.69	8.19
BS 187-5	052418700000	Bracket bar	7.17	8.07	9.17
BSH-5	052400000000	Bracket bar support			
Assembly set	052400000001	Assembly set			

D5 CHAIN BRACKET COVER

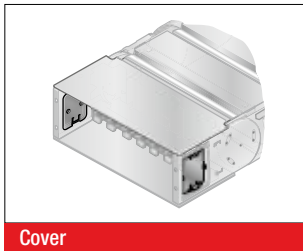

Self-locking covers close the side mounting window on the flexible chain bracket (KA-FB/FG).

Type	Order No.
D5 Cover	0523888002

MP 52.3 CHAIN BRACKET CANOPY

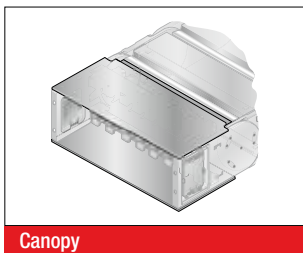

Constructed from aluminum, the canopies for the flexible chain bracket (KA-FB/FG) ensure a continuously closed system for chains with covers.

Canopy for chain bracket, fixed point outside bend: Type and Order No. configurator



Type:	KA 52.1 FB/FG AB	Inside width	2-2
Order No.:	0521	Inside width	060

Canopy for chain bracket, fixed point inside bend: Type and Order No. configurator

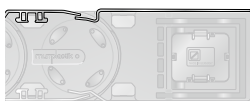

Type:	KA 52.1 FB/FG IB	Inside width	2-2
Order No.:	0521	Inside width	058

Canopy for chain bracket, moving end outside bend: Type and Order No. configurator



Type:	KA 52.1 FB/FG AB	Inside width	1-2
Order No.:	0521	Inside width	059

Canopy for chain bracket, moving end inside bend: Type and Order No. configurator



Type:	KA 52.1 FB/FG IB	Inside width	1-2
Order No.:	0521	Inside width	057

Ordering example:

0521096058 KA 52.1 FB/FG IB 096 2-2

Chain bracket canopy at fixing point in inside bend, for inside width of 3.78 in (96 mm).

RS-ZL-5 CROSSBAR STRAIN RELIEF PLATE

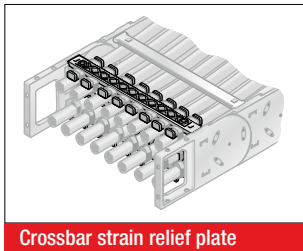

Fixed integrated crossbar strain relief plates in the chain brackets. Tailored to all crossbar widths up to 9.69 inch (246 mm). May be assembled on the inside and outside bends at both chain endings.

Type	Order No.	Description	Inside width inch
RS-ZL 045-5	052004500010	Crossbar strain relief plate	1.77
RS-ZL 057-5	052005700010	Crossbar strain relief plate	2.24
RS-ZL 062-5	052006200010	Crossbar strain relief plate	2.44
RS-ZL 071-5	052007100010	Crossbar strain relief plate	2.80
RS-ZL 084-5	052008400010	Crossbar strain relief plate	3.31
RS-ZL 093-5	052009300010	Crossbar strain relief plate	3.66
RS-ZL 096-5	052009600010	Crossbar strain relief plate	3.78
RS-ZL 104-5	052010400010	Crossbar strain relief plate	4.09
RS-ZL 107-5	052010700010	Crossbar strain relief plate	4.21
RS-ZL 121-5	052012100010	Crossbar strain relief plate	4.76
RS-ZL 133-5	052013300010	Crossbar strain relief plate	5.24
RS-ZL 144-5	052014400010	Crossbar strain relief plate	5.67
RS-ZL 146-5	052014600010	Crossbar strain relief plate	5.75
RS-ZL 158-5	052015800010	Crossbar strain relief plate	6.22
RS-ZL 164-5	052016400010	Crossbar strain relief plate	6.46
RS-ZL 171-5	052017100010	Crossbar strain relief plate	6.73
RS-ZL 182-5	052018200010	Crossbar strain relief plate	7.17
RS-ZL 196-5	052019600010	Crossbar strain relief plate	7.72
RS-ZL 208-5	052020800010	Crossbar strain relief plate	8.19
RS-ZL 220-5	052022000010	Crossbar strain relief plate	8.66
RS-ZL 233-5	052023300010	Crossbar strain relief plate	9.17
RS-ZL 246-5	052024600010	Crossbar strain relief plate	9.69

MP 52/62/72 LOCK BUTTON

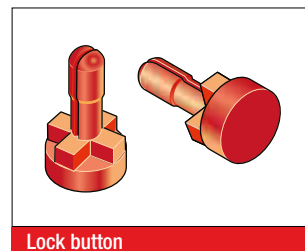
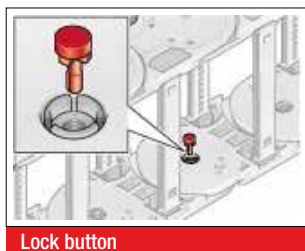
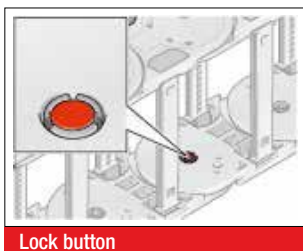

To increase the side stability we recommend the use of lock buttons during strong lateral acceleration or when installed “laying

on the side (turned 90°) without support”.

Type	Order No.
MP52/62/72 lock button	0520000080

STRAIN RELIEF WITH STEEL FIX

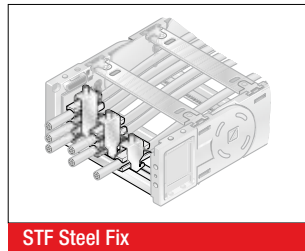
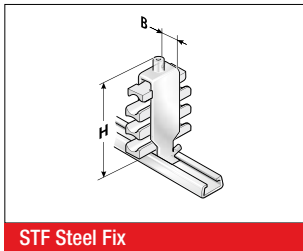

C-rails (galvanized) for permanent integration, for accommodating the Steel Fix bow clamps in the chain brackets. The bow clamps can take up to 3 cables and are suitable for C-rails with a groove width of 0.43 in (11 mm). Due to the design of the trough elements, a cable preserving cable guidance is ensured. May be assembled on the inside and outside bends at both chain endings. The overall height stated is a guide only. The actual height is, amongst other things, dependent on the diameter and the quality of the cable. A safety distance of 0.39 in (10 mm) at the fixed point above the strain relief must be kept during gliding applications.

Type	Order No.	Description	Seats qty.	Cable Ø inch	Width (B) inch	Total height (H) inch
Single clamp (for one cable)						
STF 12-1 Steel Fix	81661801	Hooped clamp	1	0.24 – 0.47	0.63	2.17
STF 14-1 Steel Fix	81661802	Hooped clamp	1	0.47 – 0.55	0.71	2.05
STF 16-1 Steel Fix	81661803	Hooped clamp	1	0.55 – 0.63	0.79	2.13
STF 18-1 Steel Fix	81661804	Hooped clamp	1	0.63 – 0.71	0.87	2.20
STF 20-1 Steel Fix	81661805	Hooped clamp	1	0.71 – 0.79	0.94	2.32
STF 22-1 Steel Fix	81661806	Hooped clamp	1	0.79 – 0.87	1.02	2.40
STF 26-1 Steel Fix	81661807	Hooped clamp	1	0.87 – 1.02	1.18	2.76
STF 30-1 Steel Fix	81661808	Hooped clamp	1	1.02 – 1.18	1.34	2.91
STF 34-1 Steel Fix	81661809	Hooped clamp	1	1.18 – 1.34	1.50	3.07
STF 38-1 Steel Fix	81661810	Hooped clamp	1	1.34 – 1.50	1.65	3.23
STF 42-1 Steel Fix	81661811	Hooped clamp	1	1.50 – 1.65	1.81	3.58
Double clamp (for two cables)						
STF 12-2 Steel Fix	81661821	Hooped clamp	2	0.24 – 0.47	0.63	2.87
STF 14-2 Steel Fix	81661822	Hooped clamp	2	0.47 – 0.55	0.71	2.91
STF 16-2 Steel Fix	81661823	Hooped clamp	2	0.55 – 0.63	0.79	3.23
STF 18-2 Steel Fix	81661824	Hooped clamp	2	0.63 – 0.71	0.87	3.39
STF 20-2 Steel Fix	81661825	Hooped clamp	2	0.71 – 0.79	0.94	3.58
STF 22-2 Steel Fix	81661826	Hooped clamp	2	0.79 – 0.87	1.02	3.74
STF 26-2 Steel Fix	81661827	Hooped clamp	2	0.87 – 1.02	1.18	4.25
STF 30-2 Steel Fix	81661828	Hooped clamp	2	1.02 – 1.18	1.34	4.76
STF 34-2 Steel Fix	81661829	Hooped clamp	2	1.18 – 1.34	1.50	5.08
Triple clamp (for three cables)						
STF 12-3 Steel Fix	81661841	Hooped clamp	3	0.24 – 0.47	0.63	3.86
STF 14-3 Steel Fix	81661842	Hooped clamp	3	0.47 – 0.55	0.71	3.86
STF 16-3 Steel Fix	81661843	Hooped clamp	3	0.55 – 0.63	0.79	4.13
STF 18-3 Steel Fix	81661844	Hooped clamp	3	0.63 – 0.71	0.87	4.37
STF 20-3 Steel Fix	81661845	Hooped clamp	3	0.71 – 0.79	0.94	4.65
STF 22-3 Steel Fix	81661846	Hooped clamp	3	0.79 – 0.87	1.02	5.12

LOWERED FIXING POINT MP 52

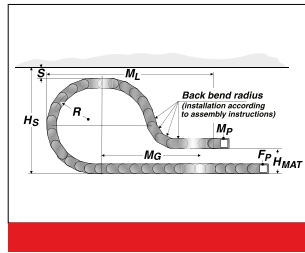
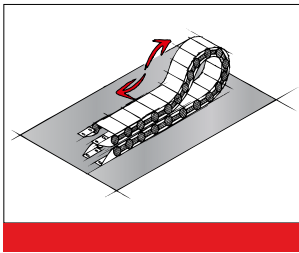

It is sometimes necessary to lower the height of the moving attachment point. In such cases, modifications to the chain layout should be noted (e.g. extension of chain). Please contact our application engineers.

Radius R inch	Height of moving end connection (H _{MA}) inch	Safety margin (S) inch	Installation height incl. safety (S) inch	Projection (M _I) inch	Additional links qty.	of which additional back chain links qty.
6.89	7.09	1.97	20.28	24.41	6	3
7.87	8.27	1.97	22.24	32.68	10	3
9.84	9.84	1.97	26.18	38.98	13	3
11.81	11.81	1.97	30.12	35.43	14	3
13.78	12.99	1.97	34.06	46.46	16	3

MP 52.2 REARWARD RADII

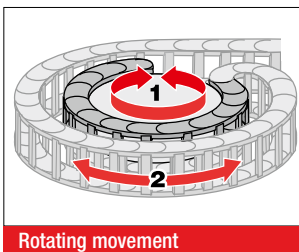

Rotating movement

Side links with forward radius (R) and rearward radius (Rü) allow movements in both directions. This is intended for rotating movements and lowered chain brackets. Note: This type of chain has different chain links for the left or right side! Rotation movements are only possible with open variants.

Type	Order No.	Radius inch	Back radius inch
SR 52.2 (RÜ200/R135) left	052200010060	5.31	7.87
SR 52.2 (RÜ200/R135) right	052200010062	5.31	7.87
SR 52.2 (RÜ200/R170) left	052200015060	6.69	7.87
SR 52.2 (RÜ200/R170) right	052200015062	6.69	7.87
SR 52.2 (RÜ200/R200) left	052200020060	7.87	7.87
SR 52.2 (RÜ200/R200) right	052200020062	7.87	7.87
SR 52.2 (RÜ200/R250) left	052200025060	9.84	7.87
SR 52.2 (RÜ200/R250) right	052200025062	9.84	7.87
SR 52.2 (RÜ200/R300) right	052200030062	11.81	7.87
SR 52.2 (RÜ200/R350) left	052200035060	13.78	7.87
SR 52.2 (RÜ200/R350) right	052200035062	13.78	7.87

GUIDE CHANNEL VAW (ALUMINUM / STAINLESS STEEL)



VAW steel galvanized / stainless steel



VAW aluminum

A range of variable guide channel systems, constructed from aluminum or stainless steel sections, is available for this cable drag chain. The variable guide channel ensures that the cable drag chain is supported and guided securely.

ASSEMBLY INSTRUCTION FLEXIBLE CHAIN BRACKET FB/FG

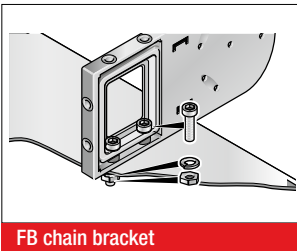

FB chain bracket

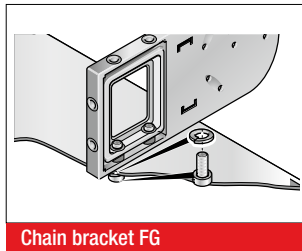

Chain bracket FG

Brass bushes guarantee long-lasting fastening without cold flow in the plastic.

Version KA-FB:

Integrated through-hole fastened down using nut and bolt.

Version KA-FG:

Built-in threads allow for quick and easy on-site mounting, since a screw, including a retaining washer where necessary, is sufficient.

ASSEMBLY

DISASSEMBLY

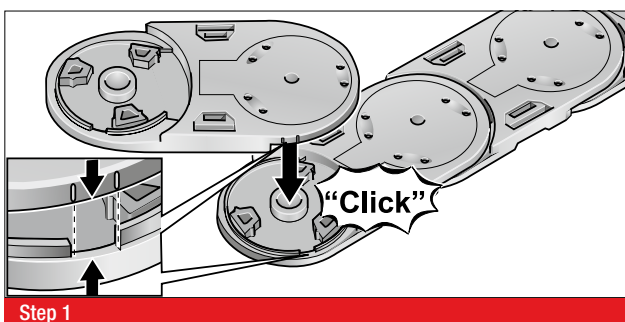

Step 1

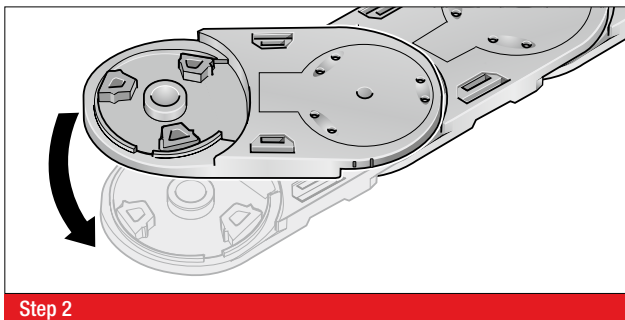

Step 2

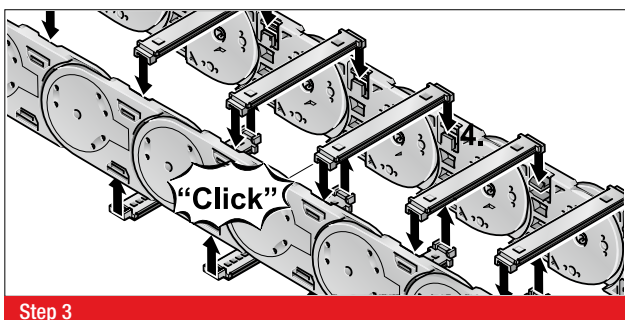

Step 3

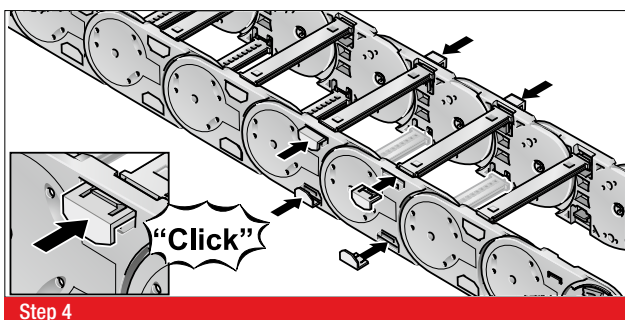

Step 4

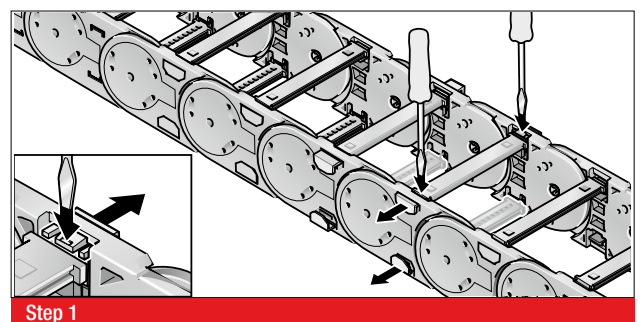

Step 1

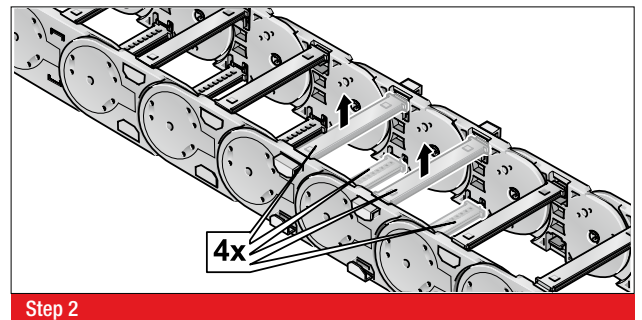

Step 2

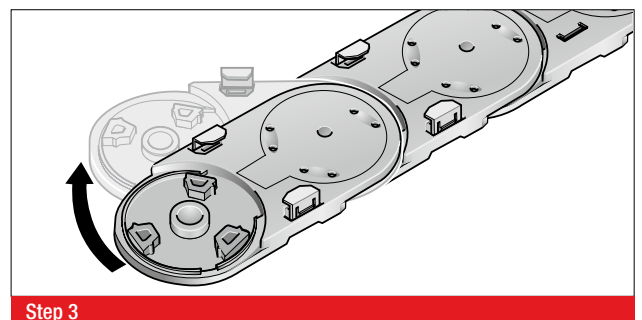

Step 3

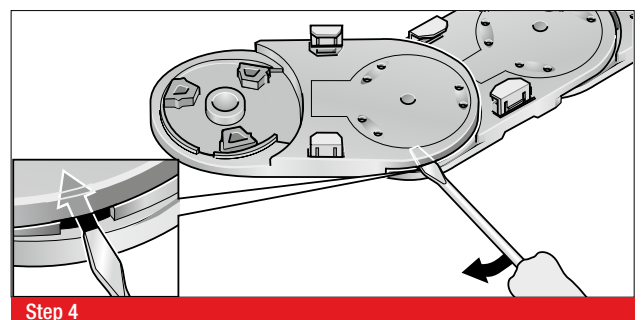

Step 4

MP 52.2-D OPEN



MP 52.3-D CLOSED



- SOFT-STOP SYSTEM
- SLIDING BLOCKS FOR LONGER SERVICE LIFE
- BROAD INTERIOR LAYOUT
- CHAIN BRACKET FLEXIBLE
- PLASTIC OR ALUMINUM VERSION

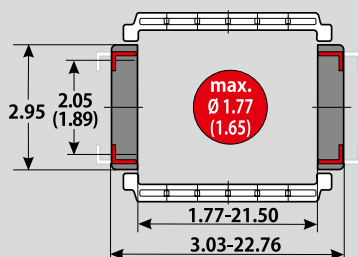

TECHNICAL DATA

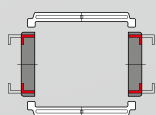

Loading side
Inside and outside bend

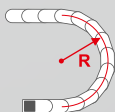

Available radii
7.87 inch

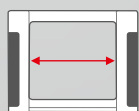

Available interior widths
With plastic crossbar
1.77 – 21.50 inch
With aluminum crossbar / cover
2.64 – 23.62 inch / 1.69 – 23.62 inch

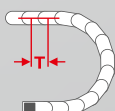

Grid
T = 3.58 inch



Noise attenuator
Reduction of the noise emission by up to 10 dB(A) by the use of damping elements in the chain links.

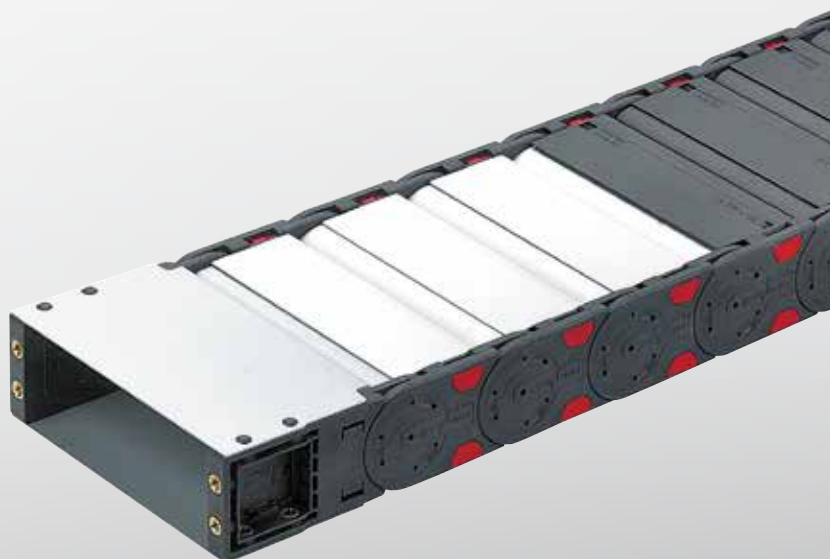

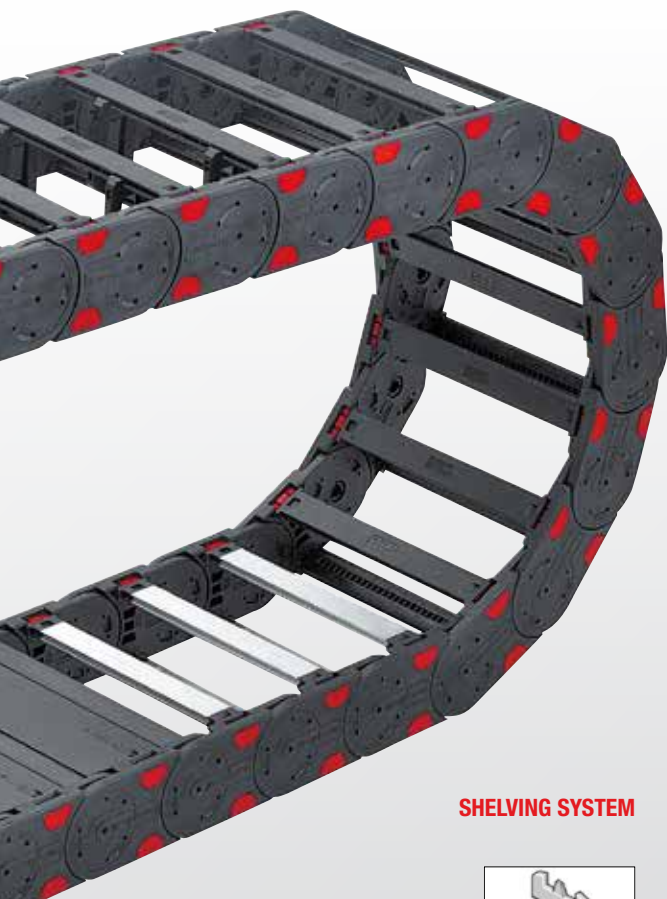

TECHNICAL SPECIFICATIONS

Travel distance gliding L_g max.	492.13 ft.
Travel distance self-supporting L_s max.	see diagram on page 237
Travel distance vertical, hanging L_{vh} max.	196.85 ft.
Travel distance vertical, upright L_{vs} max.	19.69 ft.
Rotated 90°, unsupported L_{90f} max.	6.56 ft.
Speed, gliding V_g max.	16.40 ft/s
Speed, self-supporting V_f max.	65.62 ft/s
Acceleration, gliding a_g max.	82.02 ft/s ²
Acceleration, self-supporting a_s max.	98.43 ft/s ²

Contact our engineering department to meet any higher requirements: efk@murrplastik.de

MATERIAL PROPERTIES

Standard material	Polyamide (PA) black
Service temperature	-22.00 – 248.00 °F
Gliding friction factor	0.30
Static friction factor	0.45
Fire classification	UL 94 HB

Other material properties on request

ACCESSORIES



Sliding block



Separator TR



Gliding plate

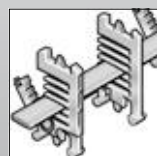

RS shelving system



Bracket bar

CHAIN BRACKET

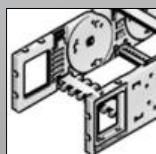

Chain bracket flexible



Crossbar connector RSV



Cover

GUIDE CHANNELS



VAW steel galvanized / stainless steel

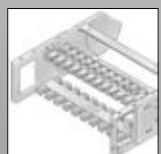

RS-ZL crossbar strain relief

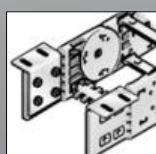

Chain bracket angle

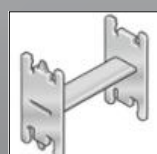

H-shaped shelf unit RE

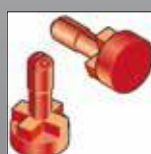

Lock button

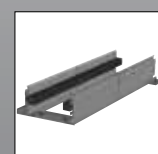

VAW aluminum

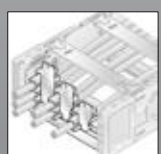

STF Steel Fix

ORDERING KEY

Dimensions in mm [US inch]

Type code	Variation	Inside width	Outside width	Inside width	Outside width	Radius	Rail variant	Material	Chain length
0522 30	MP 52.2-D open Crossbar on outside bend Crossbar on inside bend Opens on inside and outside of bend	045 ¹⁾ [1.77]	077 [3.03]	233 [9.17]	265 [10.43]	200 [7.87]	0 Plastic, full-ridged with bias	3 Polyamide with attenuator (PA/black)	
		057 ¹⁾ [2.24]	089 [3.50]	246 ²⁾ [9.69]	278 ²⁾ [10.94]				
0523 44 ³⁾	MP 52.3-D closed Cover on outside of bend Cover on inside of bend Opens on inside and outside of bend	062 ¹⁾ [2.44]	094 [3.70]	252 [9.92]	284 [11.18]		1 Plastic, full-ridged without bias	9 Special version (on request)	
		071 [2.80]	103 [4.06]	258 [10.16]	290 [11.42]				
		084 [3.31]	116 [4.57]	296 ²⁾ [11.65]	328 ²⁾ [12.91]		2 Plastic, half-ridged with bias		
		093 [3.66]	125 [4.92]	346 ²⁾ [13.62]	378 ²⁾ [14.88]				
		096 ²⁾ [3.78]	128 ²⁾ [5.04]	350 [13.78]	382 [15.04]		3 Plastic, half-ridged without bias		
		104 [4.09]	136 [5.35]	358 [14.09]	390 [15.35]				
		107 [4.21]	139 [5.47]	371 [14.61]	403 [15.87]		4 Aluminum full-ridged with bias		
		121 ²⁾ [4.76]	153 ²⁾ [6.02]	396 [15.59]	428 [16.85]				
		133 [5.24]	165 [6.50]	421 [16.57]	453 [17.83]		5 Aluminum full-ridged without bias		
		144 [5.67]	176 [6.93]	446 [17.56]	478 [18.82]				
		146 ²⁾ [5.75]	178 ²⁾ [7.01]	496 [19.53]	528 [20.79]		6 Aluminum half-ridged with bias		
		158 [6.22]	190 [7.48]	546 [21.50]	578 [22.76]				
		164 [6.46]	196 [7.72]				7 Aluminum half-ridged without bias		
		171 [6.73]	203 [7.99]						
		182 ²⁾ [7.17]	214 ²⁾ [8.43]				9 Special version (on request)		
		196 ²⁾ [7.72]	228 ²⁾ [8.98]						
		208 [8.19]	240 [9.45]						
		220 ²⁾ [8.66]	252 ²⁾ [9.92]						

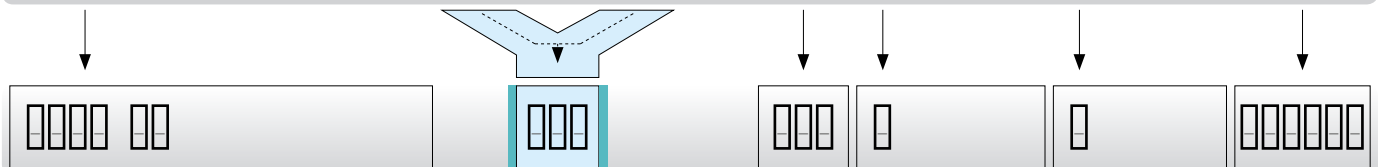

ORDERING EXAMPLE: 0522 30 220 200 1 3 9555

Crossbar on outside bend, crossbar on inside bend, can be opened from inside and outside bend
 Inside width 8.66 in. (220 mm), radius 7.87 in. (200 mm)
 Plastic crossbar, full-ridged without bias, material is black-colored polyamide with damper
 Chain length 376.18 in. (9555 mm) (105 links)

- ¹⁾ for Variant 30 only
- ²⁾ also available with plastic cover
- ³⁾ reduced inner height, reduced max. cable diameter, see chain window drawing on previous page

NOTE ON CONFIGURATION

Aluminum crossbars:

Aluminum crossbars in 0.04 in (1 mm) width sizes for inner widths from 2.64 inch – 23.62 inch are available for delivery.

Aluminum covers:

Aluminum covers in 0.04 in (1 mm) width sizes for inner widths from 1.69 inch – 23.62 inch are available for delivery.

Crossbar connector and crossbar strain relief plate:

Once inside widths exceed 9.69 inch, we recommend the deployment of crossbar connectors (RSV).

Crossbar connectors cannot be used in conjunction with covers made from plastic or aluminum.

If crossbar strain relief plates (RS-ZL) are to be deployed in the chain brackets, take standard inside widths into account.

For detailed information, please consult the corresponding product documentation.

SELF-SUPPORTING LENGTH

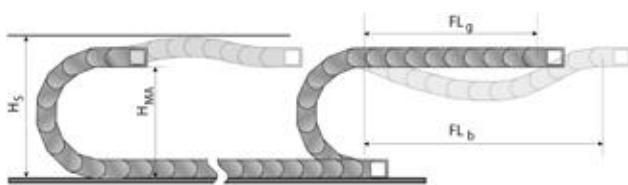

The self-supporting length is the distance between the chain bracket on the moving end and the start of the chain arch.

The installation variant FL_g offers the lowest load and wear for the cable drag chain.

The maximum travel parameters (speed and acceleration) can be applied for this variant.

H_s = Installation height plus safety

H_{MA} = Height of moving end connection

FL_g = Self-supporting length, upper run straight

FL_b = Self-supporting length, upper run bent

LOAD DIAGRAM FOR SELF-SUPPORTING APPLICATIONS

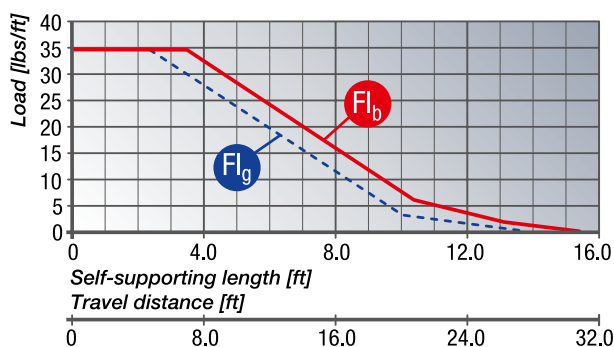

FL_g Self-supporting length, upper run straight

In the FL_g range, the chain upper run still has a bias, is straight or has a maximum sag of 2.76 inch.

FL_b Self-supporting length, upper run bent

In the FL_b range, the chain upper run has a sag of more than 2.76 inch, but this is still less than the maximum sag.

Where the sag is greater than that permitted in the FL_b range, the application is critical and should be avoided. The self-supporting length can be optimized by using a support for the upper run or a more stable cable drag chain.

Closed cable drag chains (with covers) have a higher unit weight than open chains (with crossbars). This higher weight must be taken into account when calculating the self-supporting length. To the weight of the cabling (cable load, in lbs/ft (kg/m)), you must add 1.00 lbs/ft (1.5 kg/m), to account for the higher weight of closed-cover chains.

DETERMINING THE CHAIN LENGTH

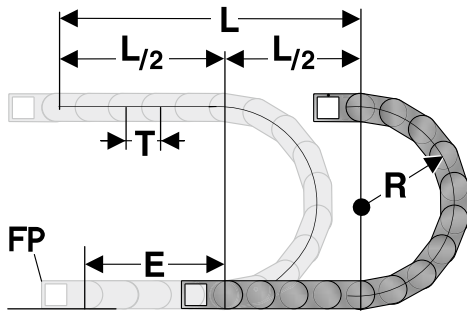

The fixed point of the cable drag chain should be connected in the middle of the travel distance. This arrangement gives the shortest connection between the fixed point (FP) and the moving bracket and thus the most efficient chain length.

Chain length calculation = $L/2 + \pi * R + E$
 $\approx 1 \text{ ft chain} = 4 \text{ qty.} \times 3.58 \text{ inch.}$

- E = Distance between entry point and middle of travel distance
- L = Travel distance
- R = Radius
- P = Grid 3.58 inch

INSTALLATION DIMENSIONS

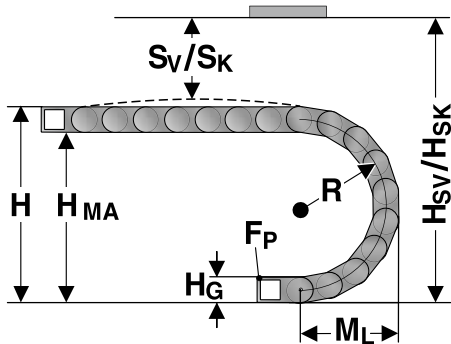

The moving end chain connection is to be screw fixed at height H_{MA} for the respective radius. Concerning the installation dimensions take into consideration, whether the chain links are equipped with damping elements or not. For chain links without damping elements, the value “Installed height with bias H_{sv} without damper” or “Installed height without bias H_{sk} without damper” must be taken into account. If the chain links are equipped with a damping element, the value “Installed height with bias H_{sv} with damper” or “Installed height without bias H_{sk} with damper” is to be taken into account.

Radius R	200
Outside height of chain link (H_o)	2.95
Height of bend (H)	404.13
Height of moving end connection (H_{MA})	401.18
Safety margin with bias (S_v)	0.79
Installation height with bias (H_{sv}) with damper	407.28
Safety margin without bias (S_k)	0.79
Installation height without bias (H_{sk}) with damper	406.10
Arc projection (M_L)	205.65

DAMPING ELEMENTS FOR THE SIDE LINKS

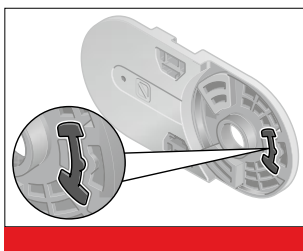

The dampening elements in the stops make for a significantly quieter unrolling of the chain links. The dampers can be chosen optionally. A reduction of the noise emission by up to 10 dB(A) comparing to the variants without the use of damping elements is possible.

POWERLINE PLASTIC CROSSBAR



Crossbar

The crossbars connect the two side runs of the cable drag chain. The crossbar length is synonymous with the inside width of the cable drag chain.

Type	Order No.	Description	Inside width inch
BS 045-5	052004500000	Crossbar	1.77
BS 057-5	052005700000	Crossbar	2.24
BS 062-5	052006200000	Crossbar	2.44
BS 071-5	052007100000	Crossbar	2.80
BS 084-5	052008400000	Crossbar	3.31
BS 093-5	052009300000	Crossbar	3.66
BS 096-5	052009600000	Crossbar	3.78
BS 104-5	052010400000	Crossbar	4.09
BS 107-5	052010700000	Crossbar	4.21
BS 121-5	052012100000	Crossbar	4.76
BS 133-5	052013300000	Crossbar	5.24
BS 144-5	052014400000	Crossbar	5.67
BS 146-5	052014600000	Crossbar	5.75
BS 158-5	052015800000	Crossbar	6.22
BS 164-5	052016400000	Crossbar	6.46
BS 171-5	052017100000	Crossbar	6.73
BS 182-5	052018200000	Crossbar	7.17
BS 196-5	052019600000	Crossbar	7.72
BS 208-5	052020800000	Crossbar	8.19
BS 220-5	052022000000	Crossbar	8.66
BS 233-5	052023300000	Crossbar	9.17
BS 246-5	052024600000	Crossbar	9.69
BS 252-5	052025200010	Crossbar	9.92
BS 258-5	052025800000	Crossbar	10.16
BS 296-5	052029600000	Crossbar	11.65
BS 346-5	052034600000	Crossbar	13.62
BS 350-5	052035000000	Crossbar	13.78
BS 358-5	052035800000	Crossbar	14.09
BS 371-5	052037100000	Crossbar	14.61
BS 396-5	052039600000	Crossbar	15.59
BS 421-5	052042100000	Crossbar	16.57
BS 446-5	052044600000	Crossbar	17.56
BS 496-5	052049600000	Crossbar	19.53
BS 546-5	052054600000	Crossbar	21.50

MP 52.3 / MP 52.5 PLASTIC COVER



The covers connect the two side runs of the cable drag chain. The cover length is synonymous with the inside width of the cable drag chain.

Type	Order No.	Description	Installation site	Inside width inch
A-523062, outside	052306210000	Cover	Outside bend	2.44
I-523062, inside	052306220000	Cover	Inside bend	2.44
A-523096, outside	052309610000	Cover	Outside bend	3.78
I-523096, inside	052309620000	Cover	Inside bend	3.78
A-523121, outside	052312110000	Cover	Outside bend	4.76
I-523121, inside	052312120000	Cover	Inside bend	4.76
A-523146, outside	052314610000	Cover	Outside bend	5.75
I-523146, inside	052314620000	Cover	Inside bend	5.75
A-523182, outside	052318210000	Cover	Outside bend	7.17
I-523182, inside	052318220000	Cover	Inside bend	7.17
A-523196, outside	052319610000	Cover	Outside bend	7.72
I-523196, inside	052319620000	Cover	Inside bend	7.72
A-523220, outside	052322010000	Cover	Outside bend	8.66
I-523220, inside	052322020000	Cover	Inside bend	8.66
A-523246, outside	052324610000	Cover	Outside bend	9.69
I-523246, inside	052324620000	Cover	Inside bend	9.69
A-523296, outside	052329610000	Cover	Outside bend	11.65
I-523296, inside	052329620000	Cover	Inside bend	11.65
A-523346, outside	052334610000	Cover	Outside bend	13.62
I-523346, inside	052334620000	Cover	Inside bend	13.62

KA 52.1 CHAIN BRACKET FLEXIBLE

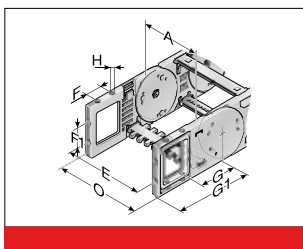

This chain bracket offers universal connection options (top, bottom and front) and is attached to the ends of the chain like a side link. This allows the chain to move right up to the bracket. Each chain requires one male and one female bracket. M8 screws are used to secure the brackets in place. Extrusion-coated metal bushes with either a through-hole (-FB) or a threaded hole (-FG) ensure the permanent, high-strength transmission of even extreme forces onto the cable drag chain.

Type	Order No.	Material	Version	Inside width							Outside width of KA 0 inch
				A inch	E inch	F inch	F1 inch	G inch	G1 inch	H inch	
KA 52.1-FB Female end	0521000056	Plastic	with bush	1.77 – 21.50	A+0.63	1.38	1.18	3.50	5.75	0.33	A+1.42
KA 52.1-FB male end	0521000057	Plastic	with bush	1.77 – 21.50	A+0.63	1.38	1.18	3.50	5.75	0.33	A+1.42
KA 52.1-FG female end	0521000058	Plastic	with thread	1.77 – 21.50	A+0.63	1.38	1.18	3.50	5.75	M8	A+1.42
KA 52.1-FG male end	0521000059	Plastic	with thread	1.77 – 21.50	A+0.63	1.38	1.18	3.50	5.75	M8	A+1.42

KA 52.1 CHAIN BRACKET ANGLE

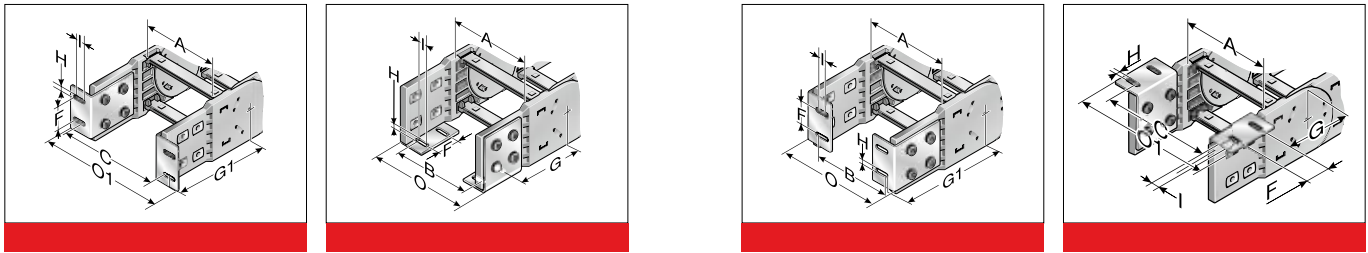

There are several options regarding the chain bracket. The fixed-point bracket (inside/bottom) and the moving end bracket (inside/top) are supplied as standard. However, any other combination can be supplied upon request. The chain bracket

is fastened at the end like a side link. This enables the chain to move right up to the bracket. Each chain requires one male and one female bracket. The brackets should be fastened with M6 screws.

Type	Order No.	Material	Inside width							Outside width of KA 0 inch	Outside width of KA 01 inch	
			A inch	B inch	C inch	F inch	G inch	G1 inch	H0 inch			I inch
KA 52.1 Female end	0521000050	Sheet steel	1.77 – 21.50	A-0.10	A+1.36	1.26	3.76	5.67	0.26	0.55	A+1.26	A+2.80
KA 52.1 Male end	0521000051	Sheet steel	1.77 – 21.50	A-0.10	A+1.36	1.26	3.76	5.67	0.26	0.55	A+1.26	A+2.80

GS 52.2 SLIDING BLOCK

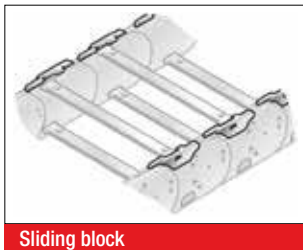

Sliding block

In the case of cable drag chains, sliding blocks are used in a horizontally sliding installation mode (the tight side of the chain slides on the slack side). The sliding blocks are set onto the side links on the interior bend instead of the usual crossbar interlocks; (no tools needed). This forces the chain to slide on the sliding blocks instead on the side links of the chain. Depending on the application, the service life of the cable drag chain may be extended five-fold, by using slide blocks. Information about the minimum bending radius of the cable drag chain at the sliding block insert is listed in the following table.

Type	Order No.	Installation site	Min. radius inch	Sliding block height inch
GS 52.2.1 right	052290400302	For right side link	5.91	0.16
GS 52.2.2 left	052290400300	For left side link	5.91	0.16

GLP 5 (52.2-D) GLIDING PLATE

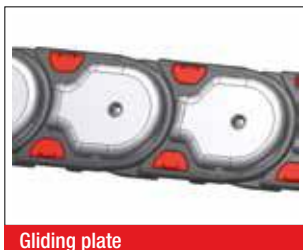

Gliding plate

The gliding plates are mounted in a horizontal position, with the chain laying on its side, to minimize friction wear to the sides. They are mounted to the side links using a special screw. The wear limit is 0.1 in (2.5 mm). We recommend replacing the cable drag chain when this limit has been reached. Depending on the application, the service life of the cable drag chain may be extended two-fold, by using gliding plates. The cable drag chain must be placed on its side before opening.

Type	Order No.	Installation site	for radius inch	Gliding plate height inch
SG 52.2-D RK200.2 right with GLP5, mounted	052200020096	Right chain link including gliding plate	7.87	0.28
SG 52.2-D RK200.2 left with GLP5, mounted	052200020094	Left chain link including gliding plate	7.87	0.28

TR 52 SEPARATOR

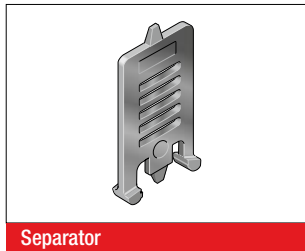
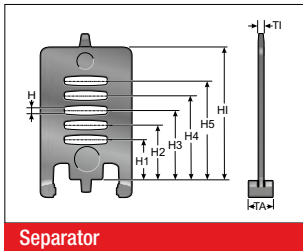

We recommend that separators be used if multiple round cables or conduits with differing diameters are to be installed. The closed separator is used when no shelves are used. This is the recommended design for travel paths of 98.42 ft (30 m) or greater.

Type	Order No.	Description	Version	TI inch	TA inch	H inch	H1 inch	H2 inch	H3 inch	H4 inch	H5 inch	Hl inch
TR 52	052000009200	TR 52 Separator	lockable	0.14	0.39	0.17	0.64	0.88	1.11	1.33	1.57	2.05

TR 52.1 SEPARATOR

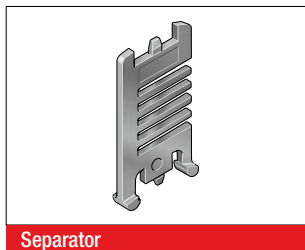
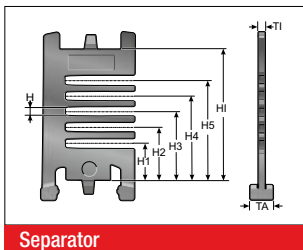

We recommend that separators be used if multiple round cables or conduits with differing diameters are to be installed.

Type	Order No.	Description	Version	TI inch	TA inch	H inch	H1 inch	H2 inch	H3 inch	H4 inch	H5 inch	Hl inch
TR 52.1	052100009200	TR 52.1 Separator	lockable	0.14	0.31	0.16	0.61	0.87	1.11	1.36	1.61	2.05

TR 52-V SEPARATOR

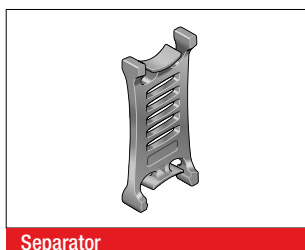
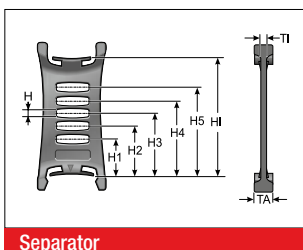

We recommend that separators be used if multiple round cables or conduits with differing diameters are to be installed.

Type	Order No.	Description	Version	TI inch	TA inch	H inch	H1 inch	H2 inch	H3 inch	H4 inch	H5 inch	Hl inch
TR 52-V	052000009300	TR 52-V Separator	movable	0.14	0.51	0.16	0.64	0.88	1.11	1.33	1.57	2.05

RTT 52 SHELF SUPPORT, DIVISIBLE

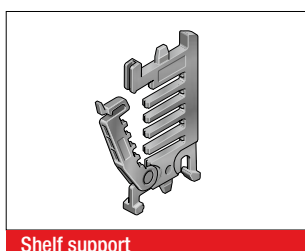
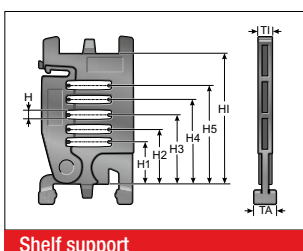

In connection with two separable shelf supports (RTT) with at least one end-to-end shelf (RB) the shelf becomes an easy to fill shelving system. The additional levels prevent cables from criss-crossing and minimize the friction between them.

Type	Order No.	Description	Version	TI inch	TA inch	H inch	H1 inch	H2 inch	H3 inch	H4 inch	H5 inch	Hl inch
RTT 52	100090522000	Shelf support, divisible	lockable	0.28	0.31	0.16	0.61	0.87	1.11	1.36	1.61	2.05

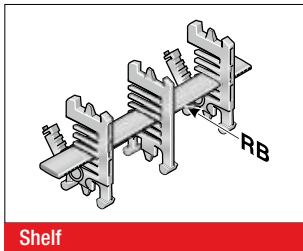
RB-5 SHELF

In connection with at least two separable shelf supports (RTT), the shelf becomes a shelving system. The additional levels prevent cables from criss-crossing and minimize the friction between them.

Type	Order No.	Description	Width inch	Inside width inch
RB 028-5	100000002800	Shelf	1.10	1.77
RB 034-5	1000003405	Shelf	1.32	1.77
RB 039-5	1000003905	Shelf	1.54	1.77
RB 045-5	1000004505	Shelf	1.76	2.24
RB 050-5	1000005005	Shelf	1.98	2.24
RB 056-5	100000005601	Shelf	2.20	2.44
RB 062-5	1000006205	Shelf	2.43	2.44
RB 067-5	1000006705	Shelf	2.65	3.31
RB 073-5	1000007305	Shelf	2.87	3.31
RB 078-5	1000007805	Shelf	3.09	3.31
RB 084-5	100000008400	Shelf	3.31	3.31
RB 090-5	1000009005	Shelf	3.53	3.78
RB 095-5	1000009505	Shelf	3.75	3.78
RB 101-5	1000010105	Shelf	3.97	4.21
RB 106-5	1000010605	Shelf	4.19	4.21
RB 112-5	100000011200	Shelf	4.41	4.76
RB 118-5	1000011805	Shelf	4.63	4.76
RB 123-5	1000012305	Shelf	4.85	5.24
RB 129-5	1000012905	Shelf	5.07	5.24
RB 134-5	1000013405	Shelf	5.29	5.67
RB 140-5	100000014000	Shelf	5.51	5.67
RB 146-5	1000014605	Shelf	5.73	6.22
RB 151-5	1000015105	Shelf	5.95	6.22
RB 157-5	1000015705	Shelf	6.17	6.46
RB 162-5	1000016205	Shelf	6.39	6.46
RB 168-5	100000016800	Shelf	6.61	7.17
RB 174-5	1000017405	Shelf	6.83	7.17
RB 179-5	1000017905	Shelf	7.06	7.72
RB 185-5	1000018505	Shelf	7.28	7.72
RB 190-5	1000019005	Shelf	7.50	7.72
RB 196-5	100000019600	Shelf	7.72	7.72
RB 291-5	100000029100	Shelf	11.46	13.62

RSV 52 CROSSBAR CONNECTOR



For crossbars wider than 9.69 inch (246 mm), we recommend the use of crossbar connectors. These prevent deformation to the crossbar under large amounts of additional weight of the chain assembly.

Type	Order No.	Description	Tl inch
RSV 52	052000009600	Crossbar connector	0.30
RSV 52 Alu	052000009800	Crossbar connector for aluminum crossbars	0.30

RE 52 H-SHAPED SHELF UNIT

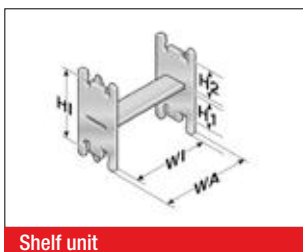

One-piece shelving system, the shelf cannot be varied in height.

Type	Order No.	Description	WA inch	WI inch	H1 inch	H2 inch	Hl inch
RE 36/17	100000361714	H-shaped shelf unit	1.67	1.44	1.22	0.69	2.05
RE 59/24	100000592414	H-shaped shelf unit	2.56	2.32	0.95	0.95	2.05
RE 81/12	100000811214	H-shaped shelf unit	3.44	3.21	1.42	0.49	2.05

BS-5 BRACKET BAR



Large-diameter conduits are routed securely by using bracket bars (BS). This bar is installed on the crossbars or the covers of the cable drag chain. The bracket bar can be installed on both the inside and outside bend.

The bracket bar support (BSH) is used to attach the bars to PowerLine series crossbars. Two bracket bar supports are required for each bar.

Type	Order No.	Description	Conduit diameter max. inch	Installation height inch	Inner chain width min. inch
BS 120-5	052412000000	Bracket bar	4.53	5.51	6.46
BS 153-5	052415300000	Bracket bar	5.83	6.69	8.19
BS 187-5	052418700000	Bracket bar	7.17	8.07	9.17
BSH-5	052400000000	Bracket bar support			
Assembly set	052400000001	Assembly set			

D5 CHAIN BRACKET COVER

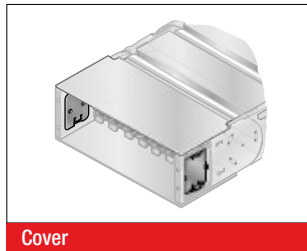

Self-locking covers close the side mounting window on the flexible chain bracket (KA-FB/FG).

Type	Order No.
D5 Cover	0523888002

MP 52.3 CHAIN BRACKET CANOPY

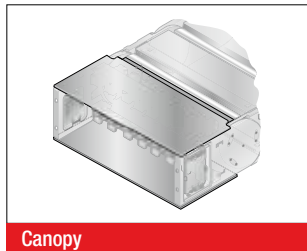

Constructed from aluminum, the canopies for the flexible chain bracket (KA-FB/FG) ensure a continuously closed system for chains with covers.

Canopy for chain bracket, fixed point outside bend: Type and Order No. configurator



Type:	KA 52.1 FB/FG AB	Inside width	2-2
Order No.:	0521	Inside width	060

Canopy for chain bracket, fixed point inside bend: Type and Order No. configurator



Type:	KA 52.1 FB/FG IB	Inside width	2-2
Order No.:	0521	Inside width	058

Canopy for chain bracket, moving end outside bend: Type and Order No. configurator



Type:	KA 52.1 FB/FG AB	Inside width	1-2
Order No.:	0521	Inside width	059

Canopy for chain bracket, moving end inside bend: Type and Order No. configurator



Type:	KA 52.1 FB/FG IB	Inside width	1-2
Order No.:	0521	Inside width	057

Ordering example:

0521096058 KA 52.1 FB/FG IB 096 2-2
Chain bracket canopy at fixing point in inside bend, for inside width of 3.78 in (96 mm).

RS-ZL-5 CROSSBAR STRAIN RELIEF PLATE

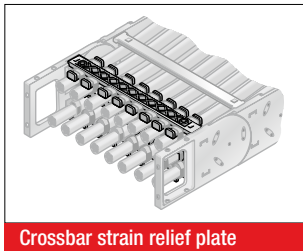

Fixed integrated crossbar strain relief plates in the chain brackets. Tailored to all crossbar widths up to 9.69 inch (246 mm). May be assembled on the inside and outside bends at both chain endings.

Type	Order No.	Description	Inside width inch
RS-ZL 045-5	052004500010	Crossbar strain relief plate	1.77
RS-ZL 057-5	052005700010	Crossbar strain relief plate	2.24
RS-ZL 062-5	052006200010	Crossbar strain relief plate	2.44
RS-ZL 071-5	052007100010	Crossbar strain relief plate	2.80
RS-ZL 084-5	052008400010	Crossbar strain relief plate	3.31
RS-ZL 093-5	052009300010	Crossbar strain relief plate	3.66
RS-ZL 096-5	052009600010	Crossbar strain relief plate	3.78
RS-ZL 104-5	052010400010	Crossbar strain relief plate	4.09
RS-ZL 107-5	052010700010	Crossbar strain relief plate	4.21
RS-ZL 121-5	052012100010	Crossbar strain relief plate	4.76
RS-ZL 133-5	052013300010	Crossbar strain relief plate	5.24
RS-ZL 144-5	052014400010	Crossbar strain relief plate	5.67
RS-ZL 146-5	052014600010	Crossbar strain relief plate	5.75
RS-ZL 158-5	052015800010	Crossbar strain relief plate	6.22
RS-ZL 164-5	052016400010	Crossbar strain relief plate	6.46
RS-ZL 171-5	052017100010	Crossbar strain relief plate	6.73
RS-ZL 182-5	052018200010	Crossbar strain relief plate	7.17
RS-ZL 196-5	052019600010	Crossbar strain relief plate	7.72
RS-ZL 208-5	052020800010	Crossbar strain relief plate	8.19
RS-ZL 220-5	052022000010	Crossbar strain relief plate	8.66
RS-ZL 233-5	052023300010	Crossbar strain relief plate	9.17
RS-ZL 246-5	052024600010	Crossbar strain relief plate	9.69

MP 52/62/72 LOCK BUTTON

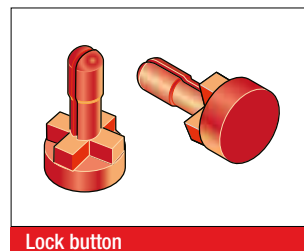
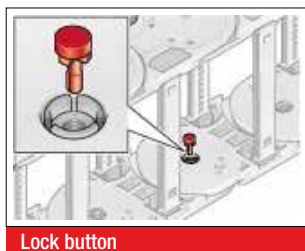
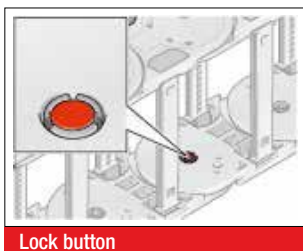

To increase the side stability we recommend the use of lock buttons during strong lateral acceleration or when installed “laying

on the side (turned 90°) without support”.

Type	Order No.
MP52/62/72 lock button	0520000080

STRAIN RELIEF WITH STEEL FIX

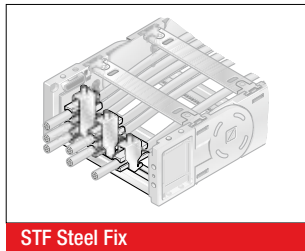
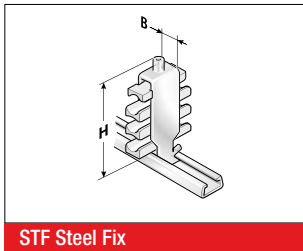

C-rails (galvanized) for permanent integration, for accommodating the Steel Fix bow clamps in the chain brackets. The bow clamps can take up to 3 cables and are suitable for C-rails with a groove width of 0.43 in (11 mm). Due to the design of the trough elements, a cable preserving cable guidance is ensured. May be assembled on the inside and outside bends at both chain endings. The overall height stated is a guide only. The actual height is, amongst other things, dependent on the diameter and the quality of the cable. A safety distance of 0.39 in (10 mm) at the fixed point above the strain relief must be kept during gliding applications.

Type	Order No.	Description	Seats qty.	Cable Ø inch	Width (B) inch	Total height (H) inch
Single clamp (for one cable)						
STF 12-1 Steel Fix	81661801	Hooped clamp	1	0.24 – 0.47	0.63	2.17
STF 14-1 Steel Fix	81661802	Hooped clamp	1	0.47 – 0.55	0.71	2.05
STF 16-1 Steel Fix	81661803	Hooped clamp	1	0.55 – 0.63	0.79	2.13
STF 18-1 Steel Fix	81661804	Hooped clamp	1	0.63 – 0.71	0.87	2.20
STF 20-1 Steel Fix	81661805	Hooped clamp	1	0.71 – 0.79	0.94	2.32
STF 22-1 Steel Fix	81661806	Hooped clamp	1	0.79 – 0.87	1.02	2.40
STF 26-1 Steel Fix	81661807	Hooped clamp	1	0.87 – 1.02	1.18	2.76
STF 30-1 Steel Fix	81661808	Hooped clamp	1	1.02 – 1.18	1.34	2.91
STF 34-1 Steel Fix	81661809	Hooped clamp	1	1.18 – 1.34	1.50	3.07
STF 38-1 Steel Fix	81661810	Hooped clamp	1	1.34 – 1.50	1.65	3.23
STF 42-1 Steel Fix	81661811	Hooped clamp	1	1.50 – 1.65	1.81	3.58
Double clamp (for two cables)						
STF 12-2 Steel Fix	81661821	Hooped clamp	2	0.24 – 0.47	0.63	2.87
STF 14-2 Steel Fix	81661822	Hooped clamp	2	0.47 – 0.55	0.71	2.91
STF 16-2 Steel Fix	81661823	Hooped clamp	2	0.55 – 0.63	0.79	3.23
STF 18-2 Steel Fix	81661824	Hooped clamp	2	0.63 – 0.71	0.87	3.39
STF 20-2 Steel Fix	81661825	Hooped clamp	2	0.71 – 0.79	0.94	3.58
STF 22-2 Steel Fix	81661826	Hooped clamp	2	0.79 – 0.87	1.02	3.74
STF 26-2 Steel Fix	81661827	Hooped clamp	2	0.87 – 1.02	1.18	4.25
STF 30-2 Steel Fix	81661828	Hooped clamp	2	1.02 – 1.18	1.34	4.76
STF 34-2 Steel Fix	81661829	Hooped clamp	2	1.18 – 1.34	1.50	5.08
Triple clamp (for three cables)						
STF 12-3 Steel Fix	81661841	Hooped clamp	3	0.24 – 0.47	0.63	3.86
STF 14-3 Steel Fix	81661842	Hooped clamp	3	0.47 – 0.55	0.71	3.86
STF 16-3 Steel Fix	81661843	Hooped clamp	3	0.55 – 0.63	0.79	4.13
STF 18-3 Steel Fix	81661844	Hooped clamp	3	0.63 – 0.71	0.87	4.37
STF 20-3 Steel Fix	81661845	Hooped clamp	3	0.71 – 0.79	0.94	4.65
STF 22-3 Steel Fix	81661846	Hooped clamp	3	0.79 – 0.87	1.02	5.12

MP 52-D LOWERED FIXING POINT

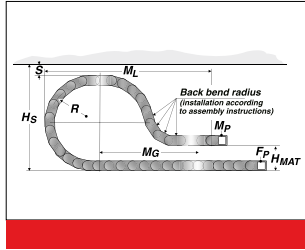
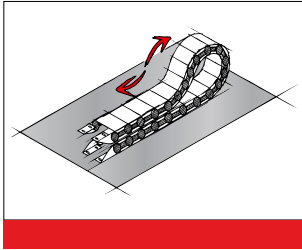

It is sometimes necessary to lower the height of the moving attachment point. In such cases, modifications to the chain layout should be noted (e.g. extension of chain). Please contact our application engineers.

Radius R inch	Height of moving end connection (H _{MA}) inch	Safety margin (S) inch	Installation height incl. safety (h _S) inch	Projection (M _L) inch	Additional links qty.	of which additional back chain links qty.
7.87	8.27	1.97	22.24	32.68	10	3

MP 52.2-D REARWARD RADII

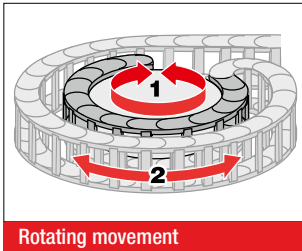

Rotating movement

Side links with forward radius (R) and rearward radius (R_ü) allow movements in both directions. This is intended for rotating movements and lowered chain brackets. Note: This type of chain has different chain links for the left or right side! Rotation movements are only possible with open variants.

Type	Order No.	Radius inch	Back radius inch
SR 52.2 (RÜ200/R200) left	SR 52.2-D (RÜ200/R200) links	7.87	7.87
SR 52.2 (RÜ200/R200) right	SR 52.2-D (RÜ200/R200) rechts	7.87	7.87

GUIDE CHANNEL VAW (ALUMINUM / STAINLESS STEEL)



VAW steel galvanized / stainless steel

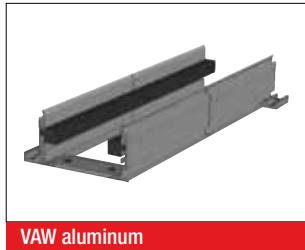

VAW aluminum

A range of variable guide channel systems, constructed from aluminum or stainless steel sections, is available for this cable drag chain. The variable guide channel ensures that the cable drag chain is supported and guided securely.

ASSEMBLY INSTRUCTION FLEXIBLE CHAIN BRACKET FB/FG

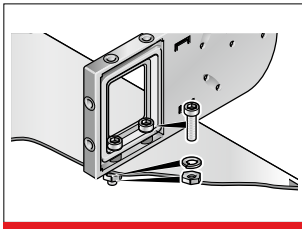

FB chain bracket

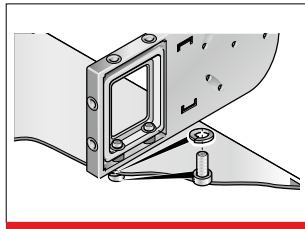

Chain bracket FG

Brass bushes guarantee long-lasting fastening without cold flow in the plastic.

Version KA-FB:
Integrated through-hole fastened down using nut and bolt.
Version KA-FG:
Built-in threads allow for quick and easy on-site mounting, since a screw, including a retaining washer where necessary, is sufficient.

ASSEMBLY

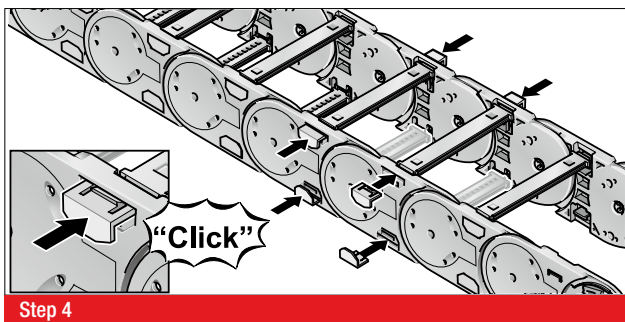
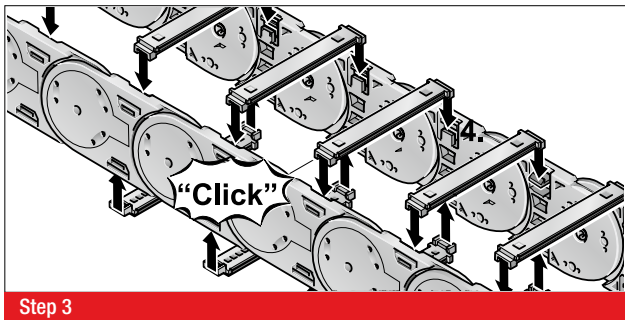
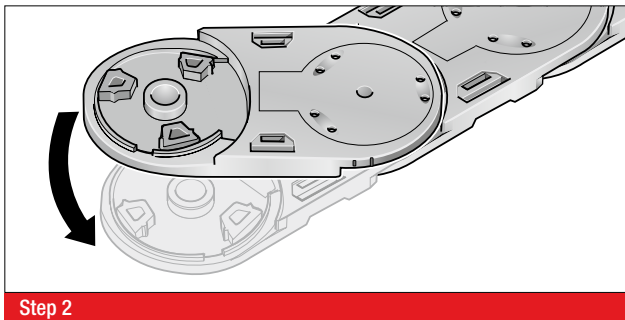
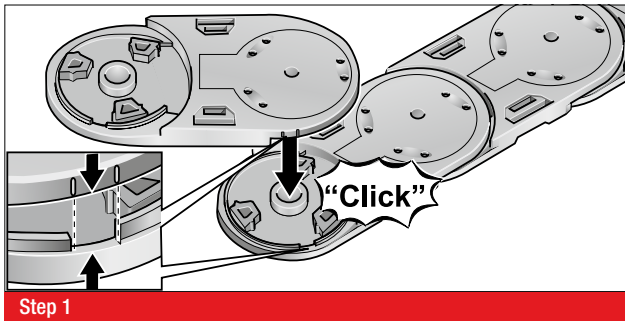

DISASSEMBLY

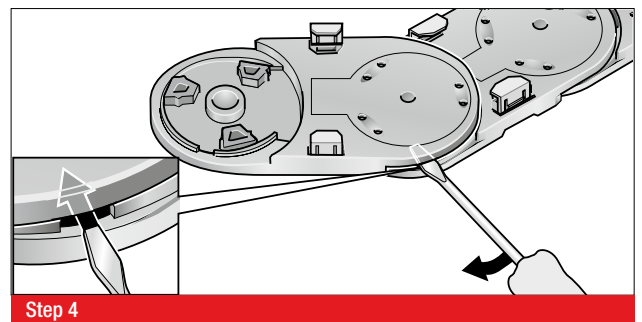
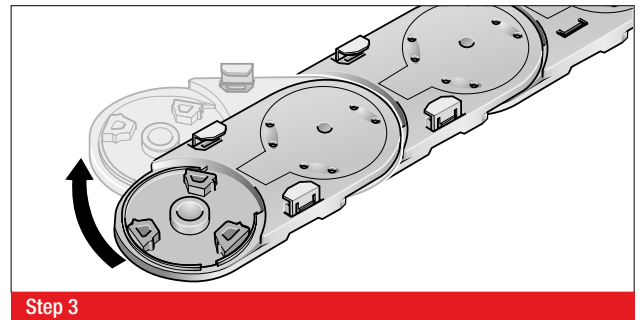
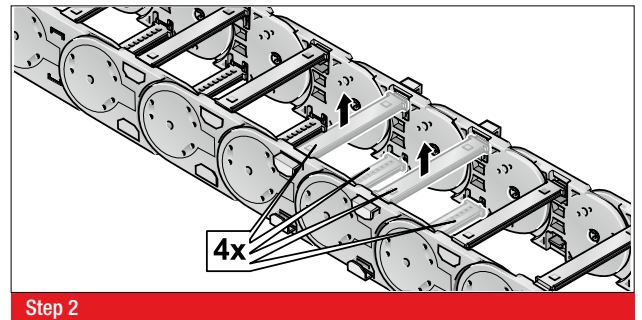
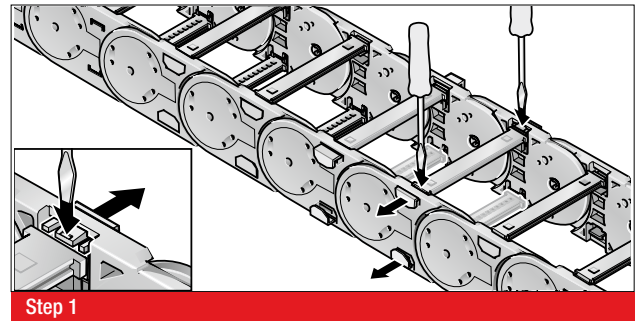

MP 52.4
OPEN



MP 52.5
CLOSED

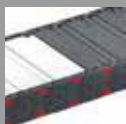

- LOW-COST VARIANT
- SOFT-STOP SYSTEM
- CHAIN BRACKET FLEXIBLE
- BROAD INTERIOR LAYOUT
- PLASTIC OR ALUMINUM VERSION

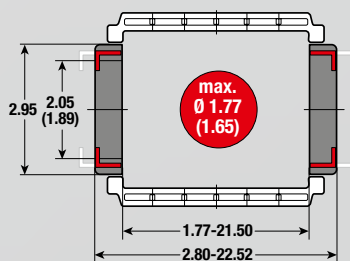

TECHNICAL DATA

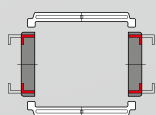

Loading side
Inside and outside bend

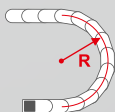

Available radii
4.92 – 11.81 inch

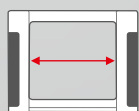

Available interior widths
With plastic crossbar
1.77 – 21.50 inch
With aluminum crossbar / cover
2.64 – 23.62 inch / 1.69 – 23.62 inch

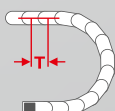

Grid
T = 3.58 inch



Noise attenuator
Reduction of the noise emission by up to 10 dB(A) by the use of damping elements in the chain links.

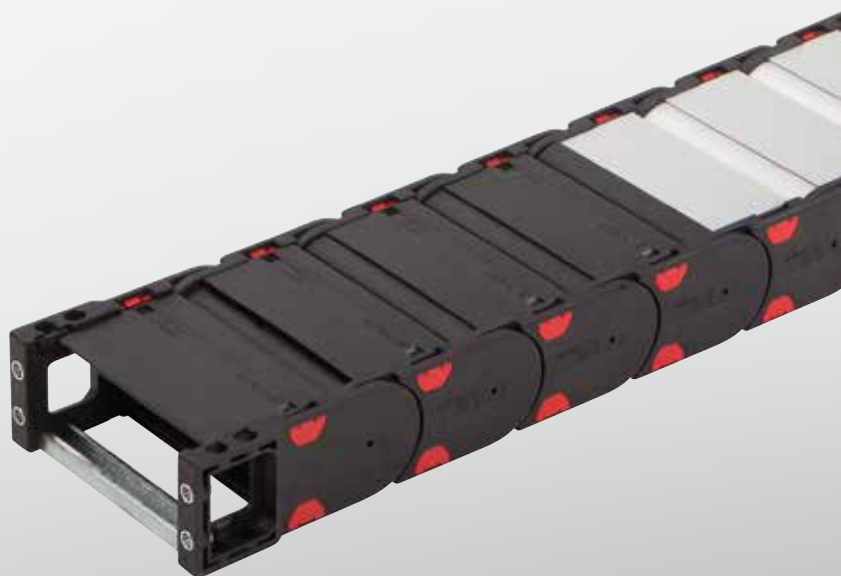



TECHNICAL SPECIFICATIONS

Travel distance gliding L_g max.	164.04 ft.
Travel distance self-supporting L_s max.	see diagram on page 253
Travel distance vertical, hanging L_{vh} max.	164.04 ft.
Travel distance vertical, upright L_{vs} max.	13.12 ft.
Rotated 90°, unsupported L_{90f} max.	3.28 ft.
Speed, gliding V_g max.	16.40 ft/s
Speed, self-supporting V_f max.	65.62 ft/s
Acceleration, gliding a_g max.	82.02 ft/s ²
Acceleration, self-supporting a_s max.	98.43 ft/s ²

Contact our engineering department to meet any higher requirements: efk@murrplastik.de

MATERIAL PROPERTIES

Standard material	Polyamide (PA) black
Service temperature	-22.00 – 248.00 °F
Gliding friction factor	0.30
Static friction factor	0.45
Fire classification	UL 94 HB

Other material properties on request

ACCESSORIES

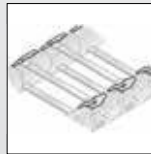

Sliding block

SHELVING SYSTEM



Separator TR

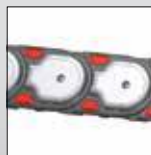

Gliding plate

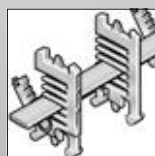

RS shelving system



Bracket bar

CHAIN BRACKET



Crossbar connector RSV



Cover

GUIDE CHANNELS



VAW steel galvanized / stainless steel



RS-ZL crossbar strain relief

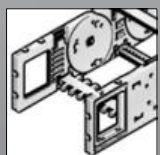

Chain bracket flexible

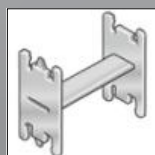

H-shaped shelf unit RE

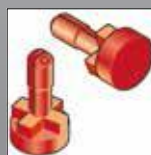

Lock button

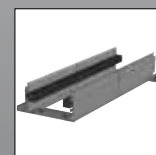

VAW aluminum



STF Steel Fix

ORDERING KEY

Dimensions in mm [US inch]

Type code	Variation	Inside width	Outside width	Inside width	Outside width	Radius	Rail variant	Material	Chain length
0524 30	MP 52.4 open Crossbar on outside bend Crossbar on inside bend Opens on inside and outside of bend	045 ¹⁾ [1.77]	071 [2.80]	233 [9.17]	259 [10.20]	125 ¹⁾ [4.92]	0 Plastic, full-ridged with bias	2 Polyamide without attenuator (PA/black)	
		057 ¹⁾ [2.24]	083 [3.27]	246 ²⁾ [9.69]	272 [10.71]				
0525 44 ³⁾	MP 52.5 closed Cover on outside of bend Cover on inside of bend Opens on inside and outside of bend	062 ¹⁾ [2.44]	088 [3.46]	252 [9.92]	278 [10.94]	135 ¹⁾ [5.31]	1 Plastic, full-ridged without bias	3 Polyamide with attenuator (PA/black)	
		071 [2.80]	097 [3.82]	258 [10.16]	284 [11.18]				
		084 [3.31]	110 [4.33]	296 ²⁾ [11.65]	322 [12.68]	150 [5.91]	2 Plastic, half-ridged with bias	9 Special version (on request)	
		093 [3.66]	119 [4.69]	346 ²⁾ [13.62]	372 [14.65]				
		096 ²⁾ [3.78]	122 [4.80]	350 [13.78]	376 [14.80]	175 [6.89]	3 Plastic, half-ridged without bias		
		104 [4.09]	130 [5.12]	358 [14.09]	384 [15.12]				
		107 [4.21]	133 [5.24]	371 [14.61]	397 [15.63]	200 [7.87]	4 Aluminum full-ridged with bias		
		121 ²⁾ [4.76]	147 [5.79]	396 [15.59]	422 [16.61]				
		133 [5.24]	159 [6.26]	421 [16.57]	447 [17.60]	250 [9.84]	5 Aluminum full-ridged without bias		
		144 [5.67]	170 [6.69]	446 [17.56]	472 [18.58]				
		146 ²⁾ [5.75]	172 [6.77]	496 [19.53]	522 [20.55]	300 [11.81]	6 Aluminum half-ridged with bias		
		158 [6.22]	184 [7.24]	546 [21.50]	572 [22.52]				
		164 [6.46]	190 [7.48]				7 Aluminum half-ridged without bias		
		171 [6.73]	197 [7.76]						
		182 ²⁾ [7.17]	208 [8.19]				9 Special version (on request)		
		196 ²⁾ [7.72]	222 [8.74]						
		208 [8.19]	234 [9.21]						
		220 ²⁾ [8.66]	246 [9.69]						

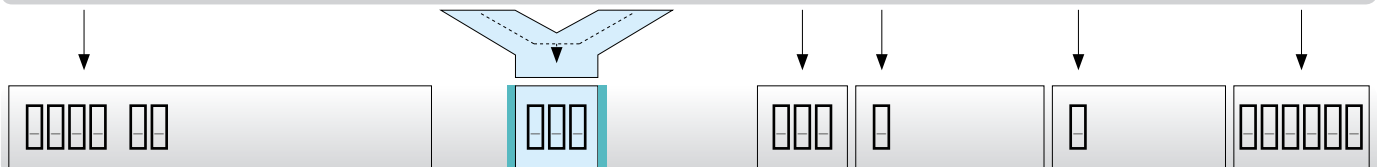

ORDERING EXAMPLE: 0524 30 220 150 0 3 2500

Crossbar on outside bend, crossbar on inside bend, can be opened from inside and outside bend
 Inside width 8.66 in. (220 mm), radius 5.91 in. (150 mm)
 Plastic, full-ridged with bias, material polyamide with damper (PA/black)
 Chain length 98.42 in. (2500 mm) (28 links)

- ¹⁾ for variant MP 52.4 only
- ²⁾ MP 52.5 also available with plastic cover
- ³⁾ reduced inner height, reduced max. cable diameter, see chain window drawing on previous page

NOTE ON CONFIGURATION

Aluminum crossbars:

Aluminum crossbars in 0.04 in (1 mm) width sizes for inner widths from 2.64 inch – 23.62 inch are available for delivery.

Aluminum covers:

Aluminum covers in 0.04 in (1 mm) width sizes for inner widths from 1.69 inch – 23.62 inch are available for delivery.

Crossbar connector and crossbar strain relief plate:

Once inside widths exceed 9.69 inch, we recommend the deployment of crossbar connectors (RSV).

Crossbar connectors cannot be used in conjunction with covers made from plastic or aluminum.

If crossbar strain relief plates (RS-ZL) are to be deployed in the chain brackets, take standard inside widths into account.

For detailed information, please consult the corresponding product documentation.

SELF-SUPPORTING LENGTH

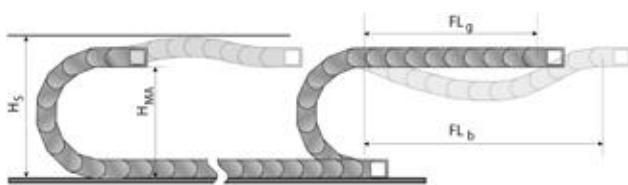

The self-supporting length is the distance between the chain bracket on the moving end and the start of the chain arch.

The installation variant FL_g offers the lowest load and wear for the cable drag chain.

The maximum travel parameters (speed and acceleration) can be applied for this variant.

H_s = Installation height plus safety

H_{MA} = Height of moving end connection

FL_g = Self-supporting length, upper run straight

FL_b = Self-supporting length, upper run bent

LOAD DIAGRAM FOR SELF-SUPPORTING APPLICATIONS

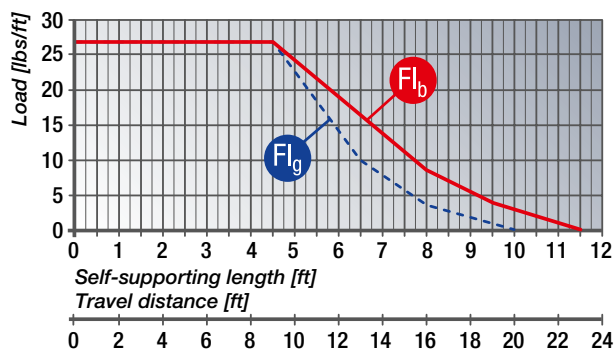

FL_g Self-supporting length, upper run straight

In the FL_g range, the chain upper run still has a bias, is straight or has a maximum sag of 2.76 inch.

FL_b Self-supporting length, upper run bent

In the FL_b range, the chain upper run has a sag of more than 2.76 inch, but this is still less than the maximum sag.

Where the sag is greater than that permitted in the FL_b range, the application is critical and should be avoided. The self-supporting length can be optimized by using a support for the upper run or a more stable cable drag chain.

Closed cable drag chains (with covers) have a higher unit weight than open chains (with crossbars). This higher weight must be taken into account when calculating the self-supporting length. To the weight of the cabling (cable load, in lbs/ft (kg/m)), you must add 1.00 lbs/ft (1.5 kg/m), to account for the higher weight of closed-cover chains.

DETERMINING THE CHAIN LENGTH

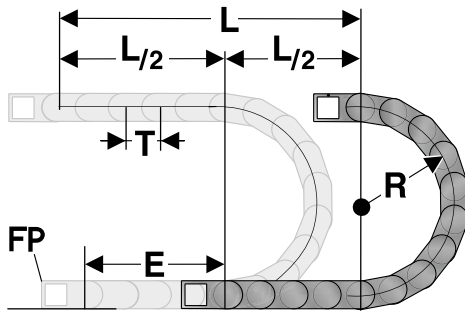

The fixed point of the cable drag chain should be connected in the middle of the travel distance.

This arrangement gives the shortest connection between the fixed point (FP) and the moving bracket and thus the most efficient chain length.

Chain length calculation = $L/2 + \pi * R + E$
 $\approx 1 \text{ ft chain} = 4 \text{ qty.} \times 3.58 \text{ inch.}$

- E = Distance between entry point and middle of travel distance
- L = Travel distance
- R = Radius
- P = Grid 3.58 inch

INSTALLATION DIMENSIONS

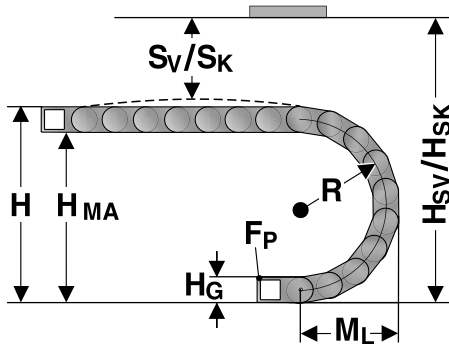

The moving end chain connection is to be screw fixed at height H_{MA} for the respective radius.

Concerning the installation dimensions take into consideration, whether the chain links are equipped with damping elements or not.

For chain links without damping elements, the value “Installed height with bias H_{sv} without damper” or “Installed height without bias H_{sk} without damper” must be taken into account.

If the chain links are equipped with a damping element, the value “Installed height with bias H_{sv} with damper” or “Installed height without bias H_{sk} with damper” is to be taken into account.

Radius R	125	135	150	175	200	250	300
Outside height of chain link (H_o)	2.95	2.95	2.95	2.95	2.95	2.95	2.95
Height of bend (H)	252.95	272.95	302.95	352.95	402.95	502.95	602.95
Height of moving end connection (H_{MA})	250.00	270.00	300.00	350.00	400.00	500.00	600.00
Safety margin with bias (S_v)	0.79	0.79	0.79	0.79	0.79	0.79	0.79
Installation height with bias (H_{sv}) without damper	256.10	276.10	306.10	356.10	406.10	506.10	606.10
Installation height with bias (H_{sv}) with damper	257.28	277.28	307.28	357.28	407.28	507.28	607.28
Safety margin without bias (S_r)	0.79	0.79	0.79	0.79	0.79	0.79	0.79
Installation height without bias (H_{sk}) without damper	253.74	273.74	303.74	353.74	403.74	503.74	603.74
Installation height without bias (H_{sk}) with damper	254.92	274.92	304.92	354.92	404.92	504.92	604.92
Arc projection (M_L)	130.06	140.06	155.06	180.06	205.06	255.06	305.06

DAMPING ELEMENTS FOR THE SIDE LINKS

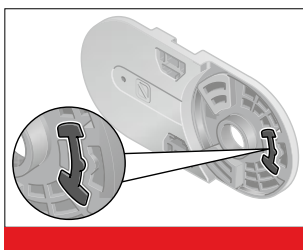

The dampening elements in the stops make for a significantly quieter unrolling of the chain links. The dampers can be chosen optionally.

A reduction of the noise emission by up to 10 dB(A) comparing to the variants without the use of damping elements is possible.

POWERLINE PLASTIC CROSSBAR

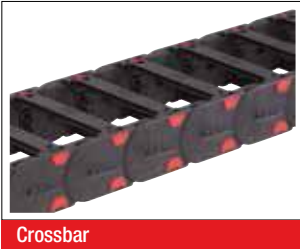

Crossbar

The crossbars connect the two side runs of the cable drag chain. The crossbar length is synonymous with the inside width of the cable drag chain.

Type	Order No.	Description	Inside width inch
BS 045-5	052004500000	Crossbar	1.77
BS 057-5	052005700000	Crossbar	2.24
BS 062-5	052006200000	Crossbar	2.44
BS 071-5	052007100000	Crossbar	2.80
BS 084-5	052008400000	Crossbar	3.31
BS 093-5	052009300000	Crossbar	3.66
BS 096-5	052009600000	Crossbar	3.78
BS 104-5	052010400000	Crossbar	4.09
BS 107-5	052010700000	Crossbar	4.21
BS 121-5	052012100000	Crossbar	4.76
BS 133-5	052013300000	Crossbar	5.24
BS 144-5	052014400000	Crossbar	5.67
BS 146-5	052014600000	Crossbar	5.75
BS 158-5	052015800000	Crossbar	6.22
BS 164-5	052016400000	Crossbar	6.46
BS 171-5	052017100000	Crossbar	6.73
BS 182-5	052018200000	Crossbar	7.17
BS 196-5	052019600000	Crossbar	7.72
BS 208-5	052020800000	Crossbar	8.19
BS 220-5	052022000000	Crossbar	8.66
BS 233-5	052023300000	Crossbar	9.17
BS 246-5	052024600000	Crossbar	9.69
BS 252-5	052025200010	Crossbar	9.92
BS 258-5	052025800000	Crossbar	10.16
BS 296-5	052029600000	Crossbar	11.65
BS 346-5	052034600000	Crossbar	13.62
BS 350-5	052035000000	Crossbar	13.78
BS 358-5	052035800000	Crossbar	14.09
BS 371-5	052037100000	Crossbar	14.61
BS 396-5	052039600000	Crossbar	15.59
BS 421-5	052042100000	Crossbar	16.57
BS 446-5	052044600000	Crossbar	17.56
BS 496-5	052049600000	Crossbar	19.53
BS 546-5	052054600000	Crossbar	21.50

MP 52.3 / MP 52.5 PLASTIC COVER



The covers connect the two side runs of the cable drag chain. The cover length is synonymous with the inside width of the cable drag chain.

Type	Order No.	Description	Installation site	Inside width inch
A-523062, outside	052306210000	Cover	Outside bend	2.44
I-523062, inside	052306220000	Cover	Inside bend	2.44
A-523096, outside	052309610000	Cover	Outside bend	3.78
I-523096, inside	052309620000	Cover	Inside bend	3.78
A-523121, outside	052312110000	Cover	Outside bend	4.76
I-523121, inside	052312120000	Cover	Inside bend	4.76
A-523146, outside	052314610000	Cover	Outside bend	5.75
I-523146, inside	052314620000	Cover	Inside bend	5.75
A-523182, outside	052318210000	Cover	Outside bend	7.17
I-523182, inside	052318220000	Cover	Inside bend	7.17
A-523196, outside	052319610000	Cover	Outside bend	7.72
I-523196, inside	052319620000	Cover	Inside bend	7.72
A-523220, outside	052322010000	Cover	Outside bend	8.66
I-523220, inside	052322020000	Cover	Inside bend	8.66
A-523246, outside	052324610000	Cover	Outside bend	9.69
I-523246, inside	052324620000	Cover	Inside bend	9.69
A-523296, outside	052329610000	Cover	Outside bend	11.65
I-523296, inside	052329620000	Cover	Inside bend	11.65
A-523346, outside	052334610000	Cover	Outside bend	13.62
I-523346, inside	052334620000	Cover	Inside bend	13.62

KA 52.4 CHAIN BRACKET FLEXIBLE

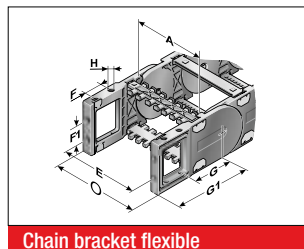
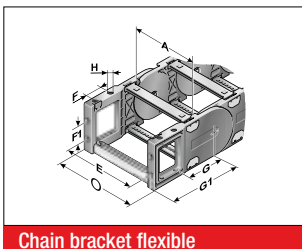

This chain bracket offers universal connection options (top, bottom and front) and is attached to the ends of the cable drag chain like a side link. This allows the chain to move right up to the bracket. Each chain requires one male and one female bracket. M8 screws are used to secure the brackets in place. Press-in metal metal bushes with either a through-hole (-FB) or a threaded hole (-FG) ensure the permanent, high-strength transmission of even extreme forces onto the cable drag chain.

Type	Order No.	Material	Version	Inside width							Outside width of KA 0 inch
				A inch	E inch	F inch	F1 inch	G inch	G1 inch	H inch	
KA 52.4-FB Female end	0524000050	Plastic	with bush	1.77 – 21.50	A+0.63	0.79	1.18	3.35	4.92	0.35	A+1.34
KA 52.4-FB Female end, pendular	0524000052	Plastic	with bush	1.77 – 21.50	A+0.63	0.79	1.18	3.35	4.92	0.35	A+1.34
KA 52.4-FB male end	0524000051	Plastic	with bush	1.77 – 21.50	A+0.63	0.79	1.18	3.35	4.92	0.35	A+1.34
KA 52.4-FG female end	0524000053	Plastic	with thread	1.77 – 21.50	A+0.63	0.79	1.18	3.35	4.92	M8	A+1.34
KA 52.4-FG Female end, pendular	0524000055	Plastic	with thread	1.77 – 21.50	A+0.63	0.79	1.18	3.35	4.92	M8	A+1.34
KA 52.4-FG male end	0524000054	Plastic	with thread	1.77 – 21.50	A+0.63	0.79	1.18	3.35	4.92	M8	A+1.34

GS 52.4 SLIDING BLOCK

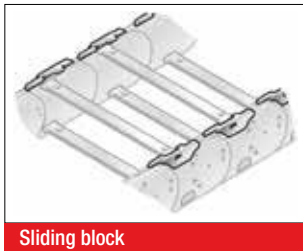

In the case of cable drag chains, sliding blocks are used in a horizontally sliding installation mode (the tight side of the chain slides on the slack side). The sliding blocks are set onto the side links on the interior bend instead of the usual crossbar interlocks; (no tools needed). This forces the chain to slide on the sliding blocks instead on the side links of the chain. Depending on the application, the service life of the cable drag chain may be extended five-fold, by using slide blocks. Information about the minimum bending radius of the cable drag chain at the sliding block insert is listed in the following table.

Type	Order No.	Installation site	Min. radius inch	Sliding block height inch
GS 52.4.1 right	052490400302	For right side link	5.91	0.16
GS 52.4.2 left	052490400300	For left side link	5.91	0.16

GLP 5 (52.4) GLIDING PLATE

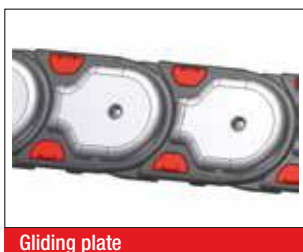

The gliding plates are mounted in a horizontal position, with the chain laying on its side, to minimize friction wear to the sides. They are mounted to the side links using a special screw. The wear limit is 0.1 in (2.5 mm). We recommend replacing the cable drag chain when this limit has been reached. Depending on the application, the service life of the cable drag chain may be extended two-fold, by using gliding plates. The cable drag chain must be placed on its side before opening.

Type	Order No.	Installation site	for radius inch	Gliding plate height inch
SG 52.4 RK125.1 right with GLP5, mounted	052400012566	Right chain link including gliding plate	4.92	0.28
SG 52.4 RK125.2 left with GLP5, mounted	052400012564	Left chain link including gliding plate	4.92	0.28
SG 52.4 RK135.1 right with GLP5, mounted	052400013566	Right chain link including gliding plate	5.31	0.28
SG 52.4 RK135.2 left with GLP5, mounted	052400013564	Left chain link including gliding plate	5.31	0.28
SG 52.4 RK150.1 right with GLP5, mounted	052400015066	Right chain link including gliding plate	5.91	0.28
SG 52.4 RK150.2 left with GLP5, mounted	052400015064	Left chain link including gliding plate	5.91	0.28
SG 52.4 RK175.1 right with GLP5, mounted	052400017566	Right chain link including gliding plate	6.89	0.28
SG 52.4 RK175.2 left with GLP5, mounted	052400017564	Left chain link including gliding plate	6.89	0.28
SG 52.4 RK200.1 right with GLP5, mounted	052400020066	Right chain link including gliding plate	7.87	0.28
SG 52.4 RK200.2 left with GLP5, mounted	052400020064	Left chain link including gliding plate	7.87	0.28
SG 52.4 RK250.1 right with GLP5, mounted	052400025066	Right chain link including gliding plate	9.84	0.28
SG 52.4 RK250.2 left with GLP5, mounted	052400025064	Left chain link including gliding plate	9.84	0.28
SG 52.4 RK300.1 right with GLP5, mounted	052400030066	Right chain link including gliding plate	11.81	0.28
SG 52.4 RK300.2 left with GLP5, mounted	052400030064	Left chain link including gliding plate	11.81	0.28
SG 52.4-D RK125.1 right with GLP5, mounted	052400012596	Right chain link including gliding plate	4.92	0.28
SG 52.4-D RK125.2 left with GLP5, mounted	052400012594	Left chain link including gliding plate	4.92	0.28
SG 52.4-D RK135.1 right with GLP5, mounted	052400013596	Right chain link including gliding plate	5.31	0.28
SG 52.4-D RK135.2 left with GLP5, mounted	052400013594	Left chain link including gliding plate	5.31	0.28
SG 52.4-D RK150.1 right with GLP5, mounted	052400015096	Right chain link including gliding plate	5.91	0.28
SG 52.4-D RK150.2 left with GLP5, mounted	052400015094	Left chain link including gliding plate	5.91	0.28
SG 52.4-D RK175.1 right with GLP5, mounted	052400017596	Right chain link including gliding plate	6.89	0.28
SG 52.4-D RK175.2 left with GLP5, mounted	052400017594	Left chain link including gliding plate	6.89	0.28
SG 52.4-D RK200.1 right with GLP5, mounted	052400020096	Right chain link including gliding plate	7.87	0.28
SG 52.4-D RK200.2 left with GLP5, mounted	052400020094	Left chain link including gliding plate	7.87	0.28
SG 52.4-D RK250.1 right with GLP5, mounted	052400025096	Right chain link including gliding plate	9.84	0.28
SG 52.4-D RK250.2 left with GLP5, mounted	052400025094	Left chain link including gliding plate	9.84	0.28
SG 52.4-D RK300.1 right with GLP5, mounted	052400030096	Right chain link including gliding plate	11.81	0.28
SG 52.4-D RK300.2 left with GLP5, mounted	052400030094	Left chain link including gliding plate	11.81	0.28

TR 52 SEPARATOR

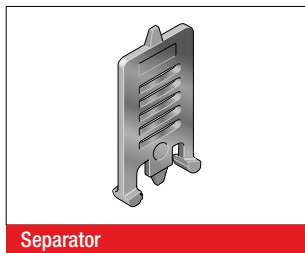
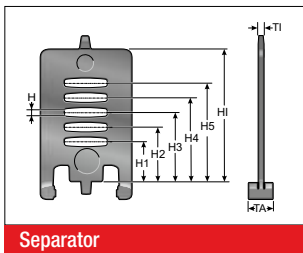

We recommend that separators be used if multiple round cables or conduits with differing diameters are to be installed. The closed separator is used when no shelves are used. This is the recommended design for travel paths of 98.42 ft (30 m) or greater.

Type	Order No.	Description	Version	TI inch	TA inch	H inch	H1 inch	H2 inch	H3 inch	H4 inch	H5 inch	Hl inch
TR 52	052000009200	TR 52 Separator	lockable	0.14	0.39	0.17	0.64	0.88	1.11	1.33	1.57	2.05

TR 52.1 SEPARATOR

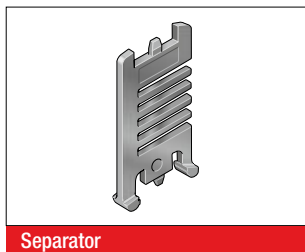
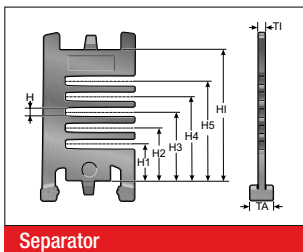

We recommend that separators be used if multiple round cables or conduits with differing diameters are to be installed.

Type	Order No.	Description	Version	TI inch	TA inch	H inch	H1 inch	H2 inch	H3 inch	H4 inch	H5 inch	Hl inch
TR 52.1	052100009200	TR 52.1 Separator	lockable	0.14	0.31	0.16	0.61	0.87	1.11	1.36	1.61	2.05

TR 52-V SEPARATOR

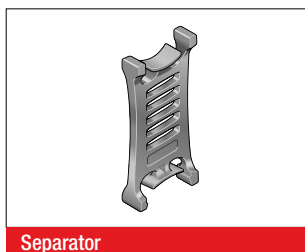
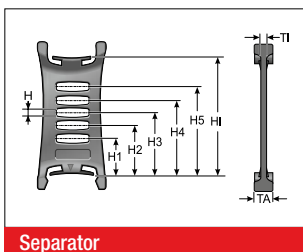

We recommend that separators be used if multiple round cables or conduits with differing diameters are to be installed.

Type	Order No.	Description	Version	TI inch	TA inch	H inch	H1 inch	H2 inch	H3 inch	H4 inch	H5 inch	Hl inch
TR 52-V	052000009300	TR 52-V Separator	movable	0.14	0.51	0.16	0.64	0.88	1.11	1.33	1.57	2.05

RTT 52 SHELF SUPPORT, DIVISIBLE

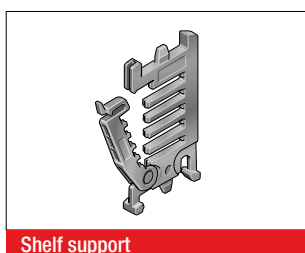
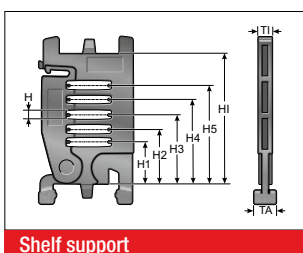

In connection with two separable shelf supports (RTT) with at least one end-to-end shelf (RB) the shelf becomes an easy to fill shelving system. The additional levels prevent cables from criss-crossing and minimize the friction between them.

Type	Order No.	Description	Version	TI inch	TA inch	H inch	H1 inch	H2 inch	H3 inch	H4 inch	H5 inch	Hl inch
RTT 52	100090522000	Shelf support, divisible	lockable	0.28	0.31	0.16	0.61	0.87	1.11	1.36	1.61	2.05

RB-5 SHELF

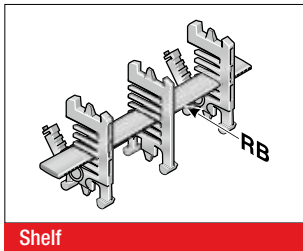

In connection with at least two separable shelf supports (RTT), the shelf becomes a shelving system. The additional levels prevent cables from criss-crossing and minimize the friction between them.

Type	Order No.	Description	Width inch	Inside width inch
RB 028-5	10000002800	Shelf	1.10	1.77
RB 034-5	1000003405	Shelf	1.32	1.77
RB 039-5	1000003905	Shelf	1.54	1.77
RB 045-5	1000004505	Shelf	1.76	2.24
RB 050-5	1000005005	Shelf	1.98	2.24
RB 056-5	10000005601	Shelf	2.20	2.44
RB 062-5	1000006205	Shelf	2.43	2.44
RB 067-5	1000006705	Shelf	2.65	3.31
RB 073-5	1000007305	Shelf	2.87	3.31
RB 078-5	1000007805	Shelf	3.09	3.31
RB 084-5	10000008400	Shelf	3.31	3.31
RB 090-5	1000009005	Shelf	3.53	3.78
RB 095-5	1000009505	Shelf	3.75	3.78
RB 101-5	1000010105	Shelf	3.97	4.21
RB 106-5	1000010605	Shelf	4.19	4.21
RB 112-5	100000011200	Shelf	4.41	4.76
RB 118-5	1000011805	Shelf	4.63	4.76
RB 123-5	1000012305	Shelf	4.85	5.24
RB 129-5	1000012905	Shelf	5.07	5.24
RB 134-5	1000013405	Shelf	5.29	5.67
RB 140-5	100000014000	Shelf	5.51	5.67
RB 146-5	1000014605	Shelf	5.73	6.22
RB 151-5	1000015105	Shelf	5.95	6.22
RB 157-5	1000015705	Shelf	6.17	6.46
RB 162-5	1000016205	Shelf	6.39	6.46
RB 168-5	100000016800	Shelf	6.61	7.17
RB 174-5	1000017405	Shelf	6.83	7.17
RB 179-5	1000017905	Shelf	7.06	7.72
RB 185-5	1000018505	Shelf	7.28	7.72
RB 190-5	1000019005	Shelf	7.50	7.72
RB 196-5	100000019600	Shelf	7.72	7.72
RB 291-5	100000029100	Shelf	11.46	13.62

RSV 52 CROSSBAR CONNECTOR



For crossbars wider than 9.69 inch (246 mm), we recommend the use of crossbar connectors. These prevent deformation to the crossbar under large amounts of additional weight of the chain assembly.

Type	Order No.	Description	TI inch
RSV 52	052000009600	Crossbar connector	0.30
RSV 52 Alu	052000009800	Crossbar connector for aluminum crossbars	0.30

RE 52 H-SHAPED SHELF UNIT

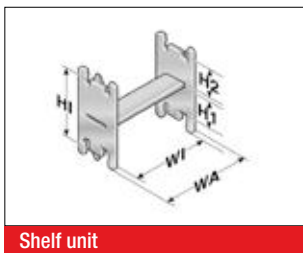

One-piece shelving system, the shelf cannot be varied in height.

Type	Order No.	Description	WA inch	WI inch	H1 inch	H2 inch	H1 inch
RE 36/17	100000361714	H-shaped shelf unit	1.67	1.44	1.22	0.69	2.05
RE 59/24	100000592414	H-shaped shelf unit	2.56	2.32	0.95	0.95	2.05
RE 81/12	100000811214	H-shaped shelf unit	3.44	3.21	1.42	0.49	2.05

BS-5 BRACKET BAR



Large-diameter conduits are routed securely by using bracket bars (BS). This bar is installed on the crossbars or the covers of the cable drag chain. The bracket bar can be installed on both the inside and outside bend.

The bracket bar support (BSH) is used to attach the bars to PowerLine series crossbars. Two bracket bar supports are required for each bar.

Type	Order No.	Description	Conduit diameter max. inch	Installation height inch	Inner chain width min. inch
BS 120-5	052412000000	Bracket bar	4.53	5.51	6.46
BS 153-5	052415300000	Bracket bar	5.83	6.69	8.19
BS 187-5	052418700000	Bracket bar	7.17	8.07	9.17
BSH-5	052400000000	Bracket bar support			
Assembly set	052400000001	Assembly set			

D4 CHAIN BRACKET COVER

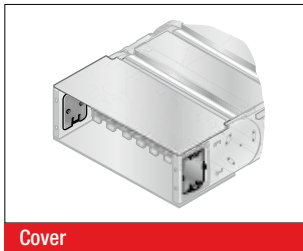

Self-locking covers close the side mounting window on the flexible chain bracket (KA-FB/FG).

Type	Order No.
D4 Cover	0413888002

RS-ZL-5 CROSSBAR STRAIN RELIEF PLATE

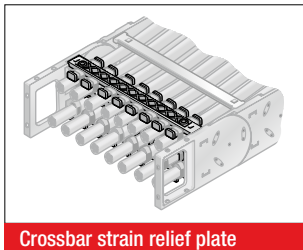

Fixed integrated crossbar strain relief plates in the chain brackets. Tailored to all crossbar widths up to 9.69 inch (246 mm). May be assembled on the inside and outside bends at both chain endings.

Type	Order No.	Description	Inside width inch
RS-ZL 045-5	052004500010	Crossbar strain relief plate	1.77
RS-ZL 057-5	052005700010	Crossbar strain relief plate	2.24
RS-ZL 062-5	052006200010	Crossbar strain relief plate	2.44
RS-ZL 071-5	052007100010	Crossbar strain relief plate	2.80
RS-ZL 084-5	052008400010	Crossbar strain relief plate	3.31
RS-ZL 093-5	052009300010	Crossbar strain relief plate	3.66
RS-ZL 096-5	052009600010	Crossbar strain relief plate	3.78
RS-ZL 104-5	052010400010	Crossbar strain relief plate	4.09
RS-ZL 107-5	052010700010	Crossbar strain relief plate	4.21
RS-ZL 121-5	052012100010	Crossbar strain relief plate	4.76
RS-ZL 133-5	052013300010	Crossbar strain relief plate	5.24
RS-ZL 144-5	052014400010	Crossbar strain relief plate	5.67
RS-ZL 146-5	052014600010	Crossbar strain relief plate	5.75
RS-ZL 158-5	052015800010	Crossbar strain relief plate	6.22
RS-ZL 164-5	052016400010	Crossbar strain relief plate	6.46
RS-ZL 171-5	052017100010	Crossbar strain relief plate	6.73
RS-ZL 182-5	052018200010	Crossbar strain relief plate	7.17
RS-ZL 196-5	052019600010	Crossbar strain relief plate	7.72
RS-ZL 208-5	052020800010	Crossbar strain relief plate	8.19
RS-ZL 220-5	052022000010	Crossbar strain relief plate	8.66
RS-ZL 233-5	052023300010	Crossbar strain relief plate	9.17
RS-ZL 246-5	052024600010	Crossbar strain relief plate	9.69

STRAIN RELIEF WITH STEEL FIX

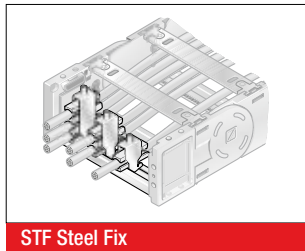
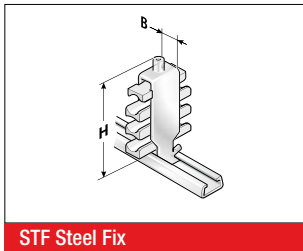

C-rails (galvanized) for permanent integration, for accommodating the Steel Fix bow clamps in the chain brackets. The bow clamps can take up to 3 cables and are suitable for C-rails with a groove width of 0.43 in (11 mm). Due to the design of the trough elements, a cable preserving cable guidance is ensured. May be assembled on the inside and outside bends at both chain endings. The overall height stated is a guide only. The actual height is, amongst other things, dependent on the diameter and the quality of the cable. A safety distance of 0.39 in (10 mm) at the fixed point above the strain relief must be kept during gliding applications.

Type	Order No.	Description	Seats qty.	Cable Ø inch	Width (B) inch	Total height (H) inch
Single clamp (for one cable)						
STF 12-1 Steel Fix	81661801	Hooped clamp	1	0.24 – 0.47	0.63	2.17
STF 14-1 Steel Fix	81661802	Hooped clamp	1	0.47 – 0.55	0.71	2.05
STF 16-1 Steel Fix	81661803	Hooped clamp	1	0.55 – 0.63	0.79	2.13
STF 18-1 Steel Fix	81661804	Hooped clamp	1	0.63 – 0.71	0.87	2.20
STF 20-1 Steel Fix	81661805	Hooped clamp	1	0.71 – 0.79	0.94	2.32
STF 22-1 Steel Fix	81661806	Hooped clamp	1	0.79 – 0.87	1.02	2.40
STF 26-1 Steel Fix	81661807	Hooped clamp	1	0.87 – 1.02	1.18	2.76
STF 30-1 Steel Fix	81661808	Hooped clamp	1	1.02 – 1.18	1.34	2.91
STF 34-1 Steel Fix	81661809	Hooped clamp	1	1.18 – 1.34	1.50	3.07
STF 38-1 Steel Fix	81661810	Hooped clamp	1	1.34 – 1.50	1.65	3.23
STF 42-1 Steel Fix	81661811	Hooped clamp	1	1.50 – 1.65	1.81	3.58
Double clamp (for two cables)						
STF 12-2 Steel Fix	81661821	Hooped clamp	2	0.24 – 0.47	0.63	2.87
STF 14-2 Steel Fix	81661822	Hooped clamp	2	0.47 – 0.55	0.71	2.91
STF 16-2 Steel Fix	81661823	Hooped clamp	2	0.55 – 0.63	0.79	3.23
STF 18-2 Steel Fix	81661824	Hooped clamp	2	0.63 – 0.71	0.87	3.39
STF 20-2 Steel Fix	81661825	Hooped clamp	2	0.71 – 0.79	0.94	3.58
STF 22-2 Steel Fix	81661826	Hooped clamp	2	0.79 – 0.87	1.02	3.74
STF 26-2 Steel Fix	81661827	Hooped clamp	2	0.87 – 1.02	1.18	4.25
STF 30-2 Steel Fix	81661828	Hooped clamp	2	1.02 – 1.18	1.34	4.76
STF 34-2 Steel Fix	81661829	Hooped clamp	2	1.18 – 1.34	1.50	5.08
Triple clamp (for three cables)						
STF 12-3 Steel Fix	81661841	Hooped clamp	3	0.24 – 0.47	0.63	3.86
STF 14-3 Steel Fix	81661842	Hooped clamp	3	0.47 – 0.55	0.71	3.86
STF 16-3 Steel Fix	81661843	Hooped clamp	3	0.55 – 0.63	0.79	4.13
STF 18-3 Steel Fix	81661844	Hooped clamp	3	0.63 – 0.71	0.87	4.37
STF 20-3 Steel Fix	81661845	Hooped clamp	3	0.71 – 0.79	0.94	4.65
STF 22-3 Steel Fix	81661846	Hooped clamp	3	0.79 – 0.87	1.02	5.12

GUIDE CHANNEL VAW (ALUMINUM / STAINLESS STEEL)



A range of variable guide channel systems, constructed from aluminum or stainless steel sections, is available for this cable drag chain. The variable guide channel ensures that the cable drag chain is supported and guided securely.

MP 52/62/72 LOCK BUTTON

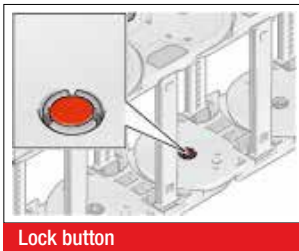

Lock button

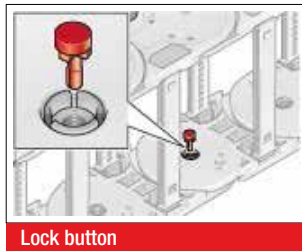

Lock button

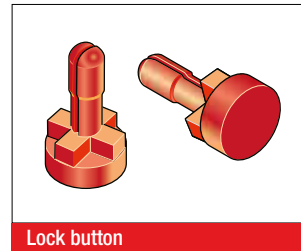

Lock button

To increase the side stability we recommend the use of lock buttons during strong lateral acceleration or when installed “laying

on the side (turned 90°) without support”.

Type	Order No.
MP52/62/72 lock button	0520000080

LOWERED FIXING POINT MP 52.4

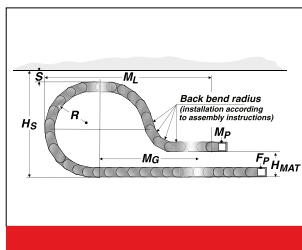
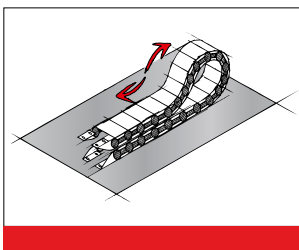

It is sometimes necessary to lower the height of the moving attachment point. In such cases, modifications to the chain layout should be noted (e.g. extension of chain). Please contact our application engineers.

Radius R inch	Height of moving end connection (H _{MA}) inch	Safety margin (S) inch	Installation height incl. safety (S) inch	Projection (M _L) inch	Additional links qty.	of which additional back chain links qty.
6.89	7.09	1.97	18.70	24.41	6	3
7.87	8.27	1.97	20.67	32.68	10	3
9.84	9.84	1.97	24.61	38.98	13	3
11.81	11.81	1.97	28.54	35.43	14	3

MP 52.4 REARWARD RADII

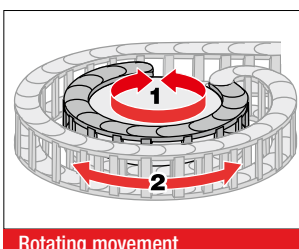

Rotating movement

Side links with forward radius (R) and rearward radius (Rü) allow movements in both directions. This is intended for rotating movements and lowered chain brackets. Note: This type of chain has different chain links for the left or right side! Rotation movements are only possible with open variants.

Type	Order No.	Radius inch	Back radius inch
SR 52.4 (RÜ200/R200.1) right	052400020062	7.87	7.87
SR 52.4 (RÜ200/R200.2) left	052400020060	7.87	7.87

ASSEMBLY INSTRUCTION FLEXIBLE CHAIN BRACKET FB/FG

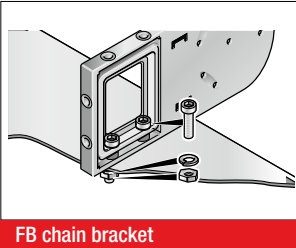

FB chain bracket

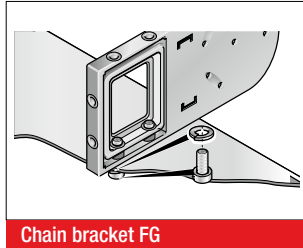

Chain bracket FG

Brass bushes guarantee long-lasting fastening without cold flow in the plastic.

Version KA-FB:

Integrated through-hole fastened down using nut and bolt.

Version KA-FG:

Built-in threads allow for quick and easy on-site mounting, since a screw, including a retaining washer where necessary, is sufficient.

ASSEMBLY

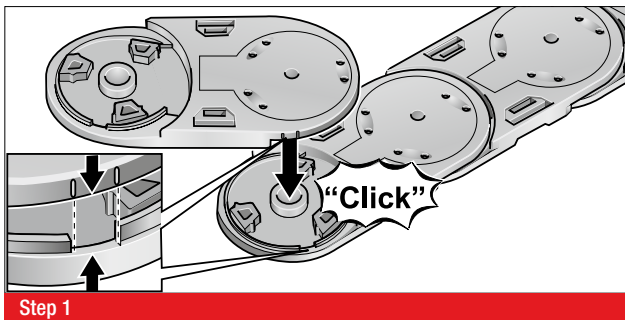

Step 1

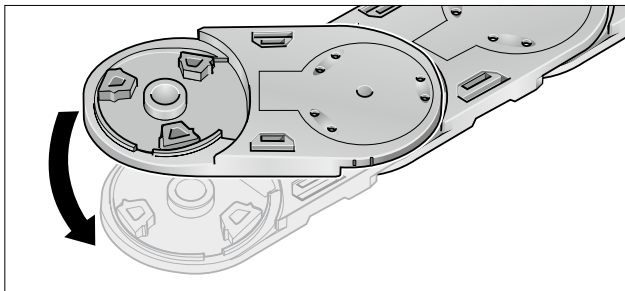

Step 2

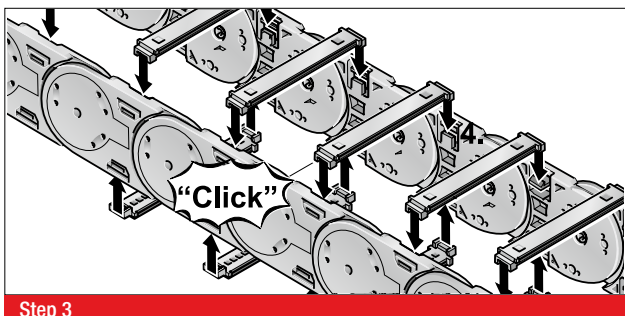

Step 3

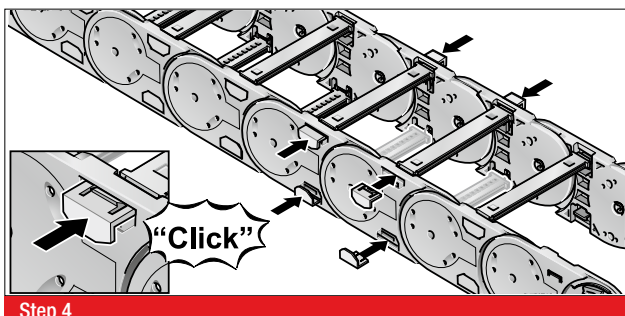

Step 4

DISASSEMBLY

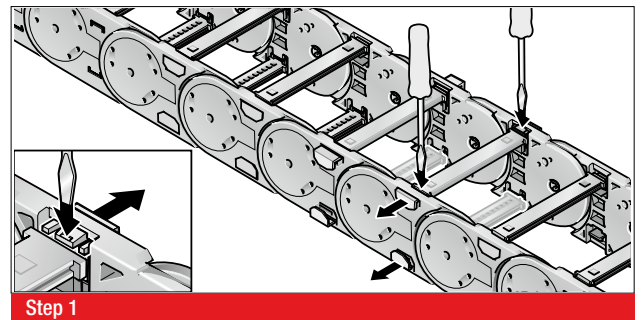

Step 1

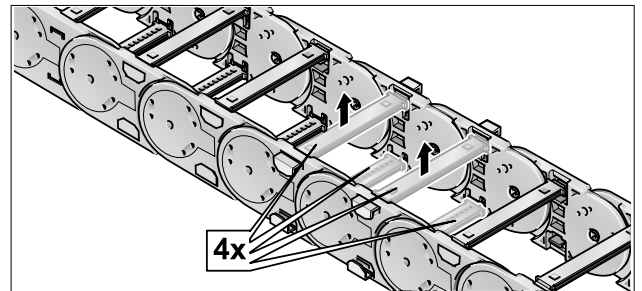

Step 2

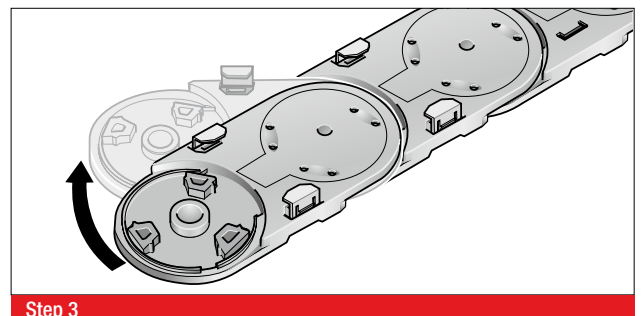

Step 3

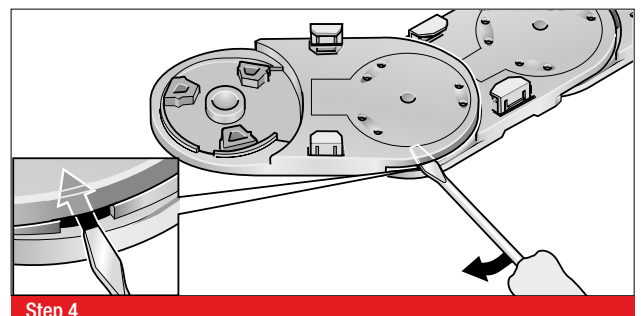

Step 4

MP 52.6 OPEN



MP 52.7 CLOSED



- FOR PARTICULARLY HIGH LOADING QUANTITIES
- FOR VERY LONG, SLIDING APPLICATIONS
- SLIDING BLOCKS FOR LONGER SERVICE LIFE
- CHAIN BRACKET FLEXIBLE

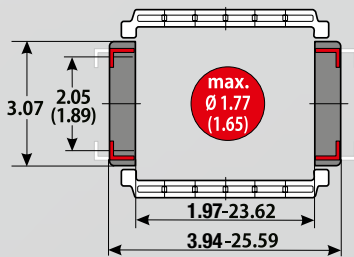

TECHNICAL DATA

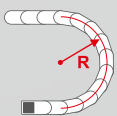

Available radii
150.0 – 11.81 inch

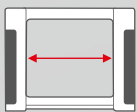

Available interior widths
With plastic crossbar
50.0 – 23.62 inch
With aluminum crossbar / cover
1.97 – 23.62 inch / 1.65 – 23.62 inch

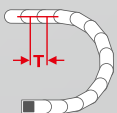

Grid
T = 3.58 inch





TECHNICAL SPECIFICATIONS

Travel distance gliding L_g max.	492.13 ft.
Travel distance vertical, hanging L_{vh} max.	262.47 ft.
Travel distance vertical, upright L_{vs} max.	19.69 ft.
Rotated 90°, unsupported L_{90r} max.	4.92 ft.
Speed, gliding V_g max.	19.69 ft/s
Acceleration, gliding a_g max.	32.81 ft/s ²

MATERIAL PROPERTIES

Standard material	Polyamide (PA) black
Service temperature	-22.00 – 248.00 °F
Gliding friction factor	0.30
Static friction factor	0.45
Fire classification	UL 94 HB

Other material properties on request

SHELVING SYSTEM



Separator TR



RS shelving system

CHAIN BRACKET

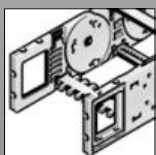

Chain bracket flexible



Crossbar connector RSV

ACCESSORIES

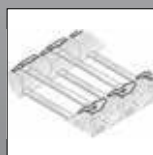

Sliding block

GUIDE CHANNELS



VAW steel galvanized / stainless steel

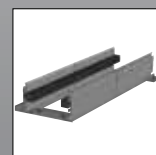

VAW aluminum

STRAIN RELIEF



STF Steel Fix

ORDERING KEY

Dimensions in mm [US inch]

Type code	Variation	Inside width	Outside width	Inside width	Outside width	Radius	Rail variant	Material	Chain length
0526 30	MP 52.6 open Crossbar on outside bend Crossbar on inside bend Opens on inside and outside of bend	050 [1.97]	100 [3.94]	252 [9.92]	302 [11.89]	150 [5.91]	5 Aluminum full-ridged without bias	0 Polyamide (PA): standard (PA/black)	
		071 [2.80]	121 [4.76]	258 [10.16]	308 [12.13]				
0527 44 ¹⁾	MP 52.7 closed Cover on outside of bend Cover on inside of bend Opens on inside and outside of bend	084 [3.31]	134 [5.28]	296 [11.65]	346 [13.62]	200 [7.87]	7 Aluminum half-ridged without bias		
		093 [3.66]	143 [5.63]	346 [13.62]	396 [15.59]				
		096 [3.78]	146 [5.75]	350 [13.78]	400 [15.75]	250 [9.84]			
		104 [4.09]	154 [6.06]	358 [14.09]	408 [16.06]				
		107 [4.21]	157 [6.18]	371 [14.61]	421 [16.57]	300 [11.81]			
		121 [4.76]	171 [6.73]	396 [15.59]	446 [17.56]				
		133 [5.24]	183 [7.20]	421 [16.57]	471 [18.54]				
		144 [5.67]	194 [7.64]	446 [17.56]	496 [19.53]				
		146 [5.75]	196 [7.72]	496 [19.53]	546 [21.50]				
		158 [6.22]	208 [8.19]	546 [21.50]	596 [23.46]				
		164 [6.46]	214 [8.43]	600 [23.62]	650 [25.59]				
		171 [6.73]	221 [8.70]						
		182 [7.17]	232 [9.13]						
		196 [7.72]	246 [9.69]						
		208 [8.19]	258 [10.16]						
		220 [8.66]	270 [10.63]						
		233 [9.17]	283 [11.14]						
		246 [9.69]	296 [11.65]						

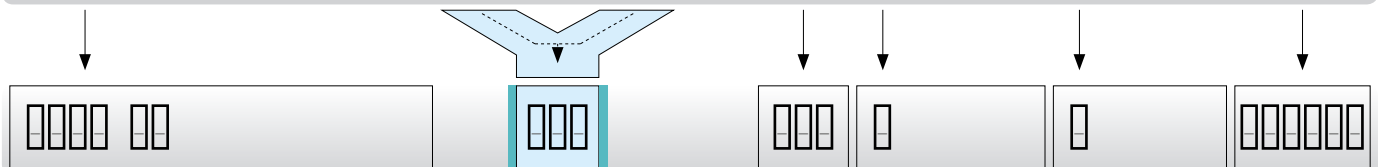

ORDERING EXAMPLE: 0526 30 220 250 5 0 25000

Crossbar on outside bend, crossbar on inside bend, can be opened from inside and outside bend
 Inside width 8.66 in. (220 mm), radius 9.84 in. (250 mm)
 Aluminum bridge, full-ridged without bias, material black-colored polyamide
 Chain length 984.25 in. (25000 mm) (275 links)

¹⁾ reduced inner height, reduced max. cable diameter, see chain window drawing on previous page

NOTE ON CONFIGURATION

Crossbars and cover from aluminum:

This cable drag chain is suitable for aluminum crossbars and covers only.

Aluminum crossbars in 0.04 in (1 mm) width sizes for inner widths from 1.97 inch – 23.62 inch are available for delivery.

Aluminum covers in 0.04 in (1 mm) width sizes for inner widths from 1.65 inch – 23.62 inch are available for delivery.

Crossbar connector and strain relief:

Once inside widths exceed 9.69 inch, we recommend the deployment of crossbar connectors (RSV).

Crossbar connectors cannot be used in conjunction with covers made from aluminum.

Steel Fix bow clamps are used for strain relief. The C-rails needed for accommodating the Steel Fix bow clamps can be integrated into the chain brackets.

For detailed information, please consult the corresponding product documentation.

DETERMINING THE CHAIN LENGTH

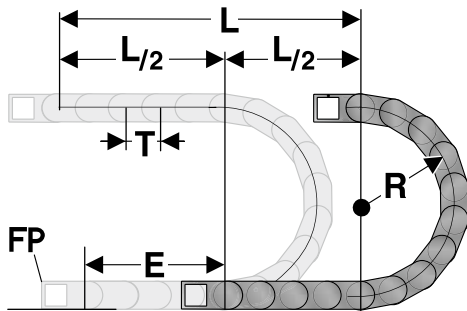

The fixed point of the cable drag chain should be connected in the middle of the travel distance.

This arrangement gives the shortest connection between the fixed point (FP) and the moving bracket and thus the most efficient chain length.

Chain length calculation = $L/2 + \pi * R + E$
 $\approx 1 \text{ ft chain} = 4 \text{ qty.} \times 3.58 \text{ inch.}$

- E = Distance between entry point and middle of travel distance
- L = Travel distance
- R = Radius
- P = Grid 3.58 inch

INSTALLATION DIMENSIONS

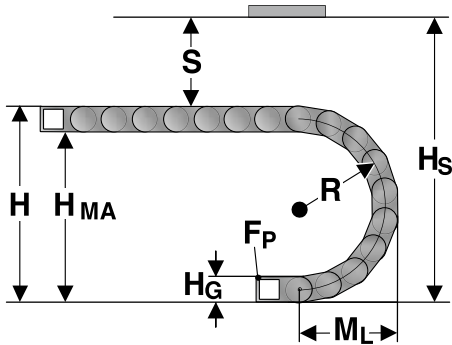

The moving end chain connection is to be screw fixed at height H_{MA} for the respective radius.

For the installed dimension the "Installed height H_s" value has to be taken into account.

Radius R	150	200	9.84	11.81
Outside height of chain link (H _o)	3.07	3.07	3.07	3.07
Height of bend (H)	303.07	403.07	22.75	26.69
Height of moving end connection (H _{MA})	300.00	400.00	19.68	23.62
Safety margin (S)	0.47	0.47	0.47	0.47
Installation height (H _s)	303.54	403.54	23.22	27.16
Arc projection (M _L)	155.12	205.12	14.96	16.93

KA 52.6 CHAIN BRACKET FLEXIBLE

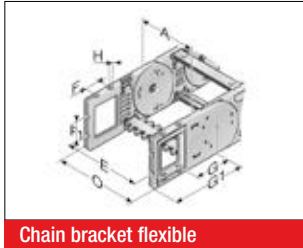

Chain bracket flexible

This chain bracket offers universal connection options (top, bottom and front) and is attached to the ends of the chain like a side link. This allows the chain to move right up to the bracket. Each chain requires one male and one female bracket. M8 screws are used to secure the brackets in place. Pressed-in metal bushes with a through-hole ensure the permanent, high-strength transmission of even extreme forces onto the cable drag chain.

Type	Order No.	Material	Version	Inside width								Outside width of KA O inch
				A inch	E inch	F inch	F1 inch	G inch	G1 inch	H0 inch		
KA 52.6-F Hole, completely	0526000050	Plastic	with bush	1.97 – 23.62	A+0.98	1.38	1.18	2.85	5.16	0.33	A+1.97	
KA 52.6-F Male end, completely	0526000051	Plastic	with bush	1.97 – 23.62	A+0.98	1.38	1.18	2.85	5.16	0.33	A+1.97	

GS 52.6 SLIDING BLOCK

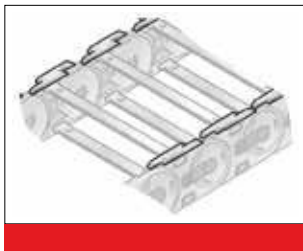

In the case of cable drag chains, sliding blocks are used in a horizontally sliding installation mode (the tight side of the chain slides on the slack side).

The sliding blocks are set onto the side links on the interior bend (no tools necessary). This forces the chain to slide on the sliding blocks instead on the side links of the chain.

Depending on the application, the service life of the cable drag chain may be extended five-fold, by using slide blocks.

Information about the minimum bending radius of the cable drag chain at the sliding block insert is listed in the following table.

Type	Order No.	Installation site	Min. radius inch	Sliding block height inch
GS 52.6.1 G	052690400306	For right side link	5.91	0.16
GS 52.6.2 G	052690400304	For left side link	5.91	0.16

TR 52 SEPARATOR

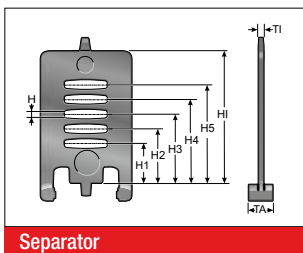

Separator

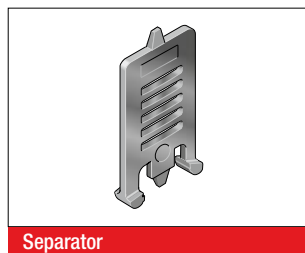

Separator

We recommend that separators be used if multiple round cables or conduits with differing diameters are to be installed. The closed separator is used when no shelves are used. This is the recommended design for travel paths of 98.42 ft (30 m) or greater.

Type	Order No.	Description	Version	TI inch	TA inch	H inch	H1 inch	H2 inch	H3 inch	H4 inch	H5 inch	H1 inch
TR 52	052000009200	TR 52 Separator	lockable	0.14	0.39	0.17	0.64	0.88	1.11	1.33	1.57	2.05

TR 52.1 SEPARATOR

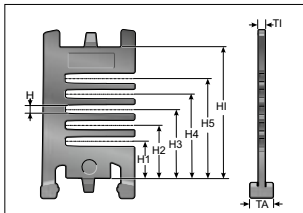

Separator

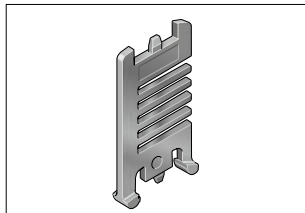

Separator

We recommend that separators be used if multiple round cables or conduits with differing diameters are to be installed.

Type	Order No.	Description	Version	Tl inch	TA inch	H inch	H1 inch	H2 inch	H3 inch	H4 inch	H5 inch	Hl inch
TR 52.1	052100009200	TR 52.1 Separator	lockable	0.14	0.31	0.16	0.61	0.87	1.11	1.36	1.61	2.05

TR 52-V SEPARATOR

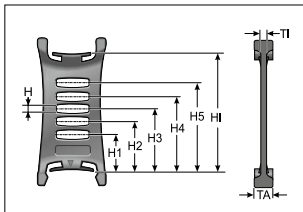

Separator

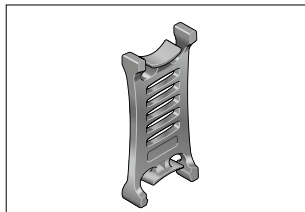

Separator

We recommend that separators be used if multiple round cables or conduits with differing diameters are to be installed.

Type	Order No.	Description	Version	Tl inch	TA inch	H inch	H1 inch	H2 inch	H3 inch	H4 inch	H5 inch	Hl inch
TR 52-V	052000009300	TR 52-V Separator	movable	0.14	0.51	0.16	0.64	0.88	1.11	1.33	1.57	2.05

RTT 52 SHELF SUPPORT, DIVISIBLE

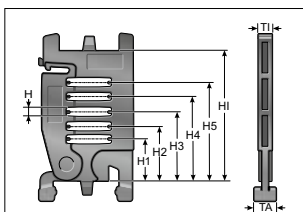

Shelf support

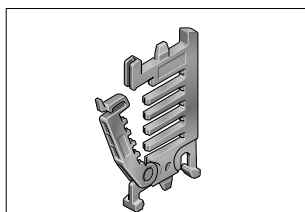

Shelf support

In connection with two separable shelf supports (RTT) with at least one end-to-end shelf (RB) the shelf becomes an easy to fill shelving system. The additional levels prevent cables from criss-crossing and minimize the friction between them.

Type	Order No.	Description	Version	Tl inch	TA inch	H inch	H1 inch	H2 inch	H3 inch	H4 inch	H5 inch	Hl inch
RTT 52	100090522000	Shelf support, divisible	lockable	0.28	0.31	0.16	0.61	0.87	1.11	1.36	1.61	2.05

RSV 52 CROSSBAR CONNECTOR



Crossbar connector

For crossbars wider than 9.69 inch (246 mm), we recommend the use of crossbar connectors. These prevent deformation to the crossbar under large amounts of additional weight of the chain assembly.

Type	Order No.	Description	Tl inch
RSV 52 Alu	052000009800	Crossbar connector for aluminum crossbars	0.30

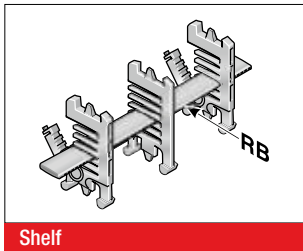
RB-5 SHELF

In connection with at least two separable shelf supports (RTT), the shelf becomes a shelving system. The additional levels prevent cables from criss-crossing and minimize the friction between them.

Type	Order No.	Description	Width inch	Inside width inch
RB 028-5	10000002800	Shelf	1.10	1.77
RB 034-5	1000003405	Shelf	1.32	1.77
RB 039-5	1000003905	Shelf	1.54	1.77
RB 045-5	1000004505	Shelf	1.76	2.24
RB 050-5	1000005005	Shelf	1.98	2.24
RB 056-5	10000005601	Shelf	2.20	2.44
RB 062-5	1000006205	Shelf	2.43	2.44
RB 067-5	1000006705	Shelf	2.65	3.31
RB 073-5	1000007305	Shelf	2.87	3.31
RB 078-5	1000007805	Shelf	3.09	3.31
RB 084-5	10000008400	Shelf	3.31	3.31
RB 090-5	1000009005	Shelf	3.53	3.78
RB 095-5	1000009505	Shelf	3.75	3.78
RB 101-5	1000010105	Shelf	3.97	4.21
RB 106-5	1000010605	Shelf	4.19	4.21
RB 112-5	100000011200	Shelf	4.41	4.76
RB 118-5	1000011805	Shelf	4.63	4.76
RB 123-5	1000012305	Shelf	4.85	5.24
RB 129-5	1000012905	Shelf	5.07	5.24
RB 134-5	1000013405	Shelf	5.29	5.67
RB 140-5	100000014000	Shelf	5.51	5.67
RB 146-5	1000014605	Shelf	5.73	6.22
RB 151-5	1000015105	Shelf	5.95	6.22
RB 157-5	1000015705	Shelf	6.17	6.46
RB 162-5	1000016205	Shelf	6.39	6.46
RB 168-5	100000016800	Shelf	6.61	7.17
RB 174-5	1000017405	Shelf	6.83	7.17
RB 179-5	1000017905	Shelf	7.06	7.72
RB 185-5	1000018505	Shelf	7.28	7.72
RB 190-5	1000019005	Shelf	7.50	7.72
RB 196-5	100000019600	Shelf	7.72	7.72
RB 291-5	100000029100	Shelf	11.46	13.62

STRAIN RELIEF WITH STEEL FIX

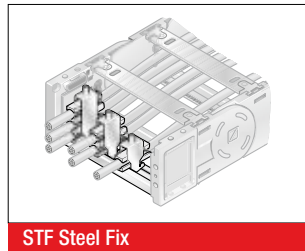
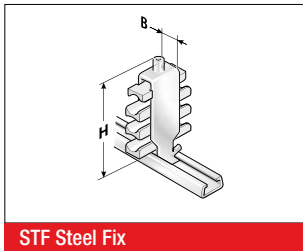

C-rails (galvanized) for permanent integration, for accommodating the Steel Fix bow clamps in the chain brackets. The bow clamps can take up to 3 cables and are suitable for C-rails with a groove width of 0.43 in (11 mm). Due to the design of the trough elements, a cable preserving cable guidance is ensured. May be assembled on the inside and outside bends at both chain endings. The overall height stated is a guide only. The actual height is, amongst other things, dependent on the diameter and the quality of the cable. A safety distance of 0.39 in (10 mm) at the fixed point above the strain relief must be kept during gliding applications.

Type	Order No.	Description	Seats qty.	Cable Ø inch	Width (B) inch	Total height (H) inch
Single clamp (for one cable)						
STF 12-1 Steel Fix	81661801	Hooped clamp	1	0.24 – 0.47	0.63	2.17
STF 14-1 Steel Fix	81661802	Hooped clamp	1	0.47 – 0.55	0.71	2.05
STF 16-1 Steel Fix	81661803	Hooped clamp	1	0.55 – 0.63	0.79	2.13
STF 18-1 Steel Fix	81661804	Hooped clamp	1	0.63 – 0.71	0.87	2.20
STF 20-1 Steel Fix	81661805	Hooped clamp	1	0.71 – 0.79	0.94	2.32
STF 22-1 Steel Fix	81661806	Hooped clamp	1	0.79 – 0.87	1.02	2.40
STF 26-1 Steel Fix	81661807	Hooped clamp	1	0.87 – 1.02	1.18	2.76
STF 30-1 Steel Fix	81661808	Hooped clamp	1	1.02 – 1.18	1.34	2.91
STF 34-1 Steel Fix	81661809	Hooped clamp	1	1.18 – 1.34	1.50	3.07
STF 38-1 Steel Fix	81661810	Hooped clamp	1	1.34 – 1.50	1.65	3.23
STF 42-1 Steel Fix	81661811	Hooped clamp	1	1.50 – 1.65	1.81	3.58
Double clamp (for two cables)						
STF 12-2 Steel Fix	81661821	Hooped clamp	2	0.24 – 0.47	0.63	2.87
STF 14-2 Steel Fix	81661822	Hooped clamp	2	0.47 – 0.55	0.71	2.91
STF 16-2 Steel Fix	81661823	Hooped clamp	2	0.55 – 0.63	0.79	3.23
STF 18-2 Steel Fix	81661824	Hooped clamp	2	0.63 – 0.71	0.87	3.39
STF 20-2 Steel Fix	81661825	Hooped clamp	2	0.71 – 0.79	0.94	3.58
STF 22-2 Steel Fix	81661826	Hooped clamp	2	0.79 – 0.87	1.02	3.74
STF 26-2 Steel Fix	81661827	Hooped clamp	2	0.87 – 1.02	1.18	4.25
STF 30-2 Steel Fix	81661828	Hooped clamp	2	1.02 – 1.18	1.34	4.76
STF 34-2 Steel Fix	81661829	Hooped clamp	2	1.18 – 1.34	1.50	5.08
Triple clamp (for three cables)						
STF 12-3 Steel Fix	81661841	Hooped clamp	3	0.24 – 0.47	0.63	3.86
STF 14-3 Steel Fix	81661842	Hooped clamp	3	0.47 – 0.55	0.71	3.86
STF 16-3 Steel Fix	81661843	Hooped clamp	3	0.55 – 0.63	0.79	4.13
STF 18-3 Steel Fix	81661844	Hooped clamp	3	0.63 – 0.71	0.87	4.37
STF 20-3 Steel Fix	81661845	Hooped clamp	3	0.71 – 0.79	0.94	4.65
STF 22-3 Steel Fix	81661846	Hooped clamp	3	0.79 – 0.87	1.02	5.12

MP 52.6 LOWERED FIXING POINT

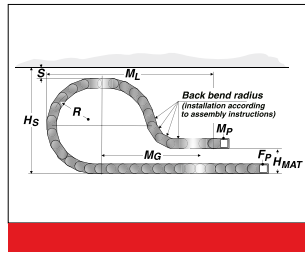
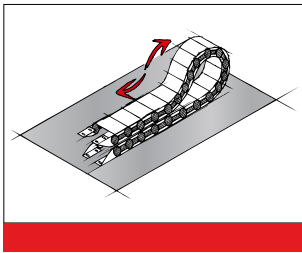

It is sometimes necessary to lower the height of the moving attachment point. In such cases, modifications to the chain layout should be noted (e.g. extension of chain). Please contact our application engineers.

Radius R inch	Height of moving end connection (H _{MA}) inch	Safety margin (S) inch	Installation height incl. safety (S) inch	Projection (M _L) inch	Additional links qty.	of which additional back chain links qty.
7.87	8.27	1.97	20.79	32.68	10	3
9.84	9.84	1.97	24.72	38.98	13	3
11.81	11.81	1.97	28.66	35.43	14	3

MP 52.6 REARWARD RADII

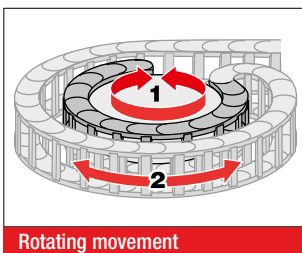

Rotating movement

Side links with forward radius (R) and rearward radius (R_Ü) allow movements in both directions. This is intended for rotating movements and lowered chain brackets. Note: This type of chain has different chain links for the left or right side! Rotation movements are only possible with open variants.

Type	Order No.	Radius inch	Back radius inch
SR 52.6 (RÜ200/R250) left	052600025060	9.84	9.84
SR 52.6 (RÜ200/R250) right	052600025062	9.84	9.84

GUIDE CHANNEL VAW (ALUMINUM / STAINLESS STEEL)



VAW steel galvanized / stainless steel



VAW aluminum

A range of variable guide channel systems, constructed from aluminum or stainless steel sections, is available for this cable drag chain. The variable guide channel ensures that the cable drag chain is supported and guided securely.

ASSEMBLY INSTRUCTION FLEXIBLE CHAIN BRACKET FB/FG

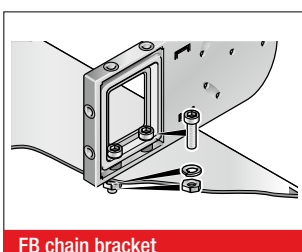

FB chain bracket

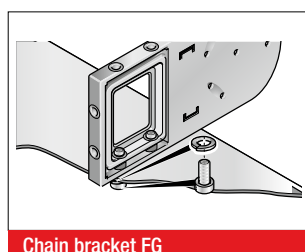

Chain bracket FG

Brass bushes guarantee long-lasting fastening without cold flow in the plastic.

Version KA-FB:

Integrated through-hole fastened down using nut and bolt.

Version KA-FG:

Built-in threads allow for quick and easy on-site mounting, since a screw, including a retaining washer where necessary, is sufficient.

ASSEMBLY

DISASSEMBLY

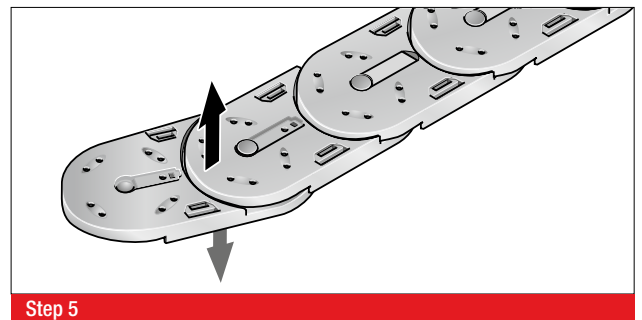
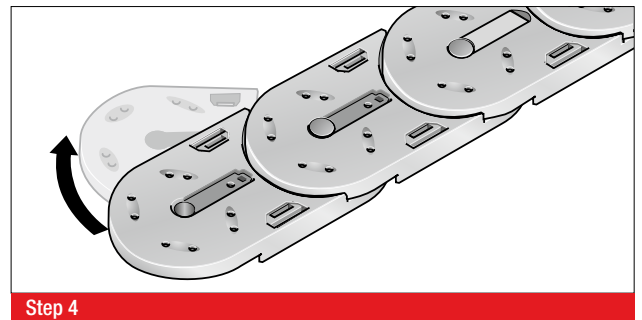
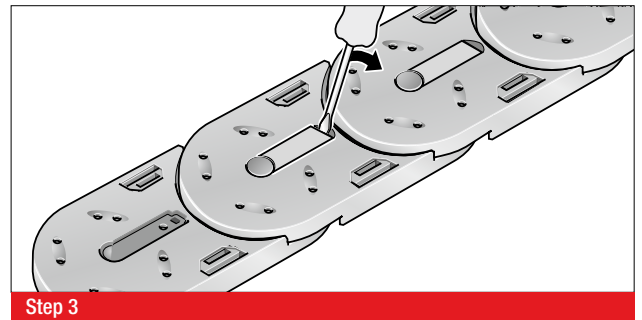
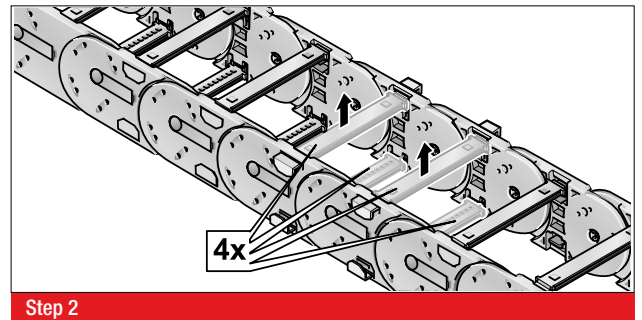
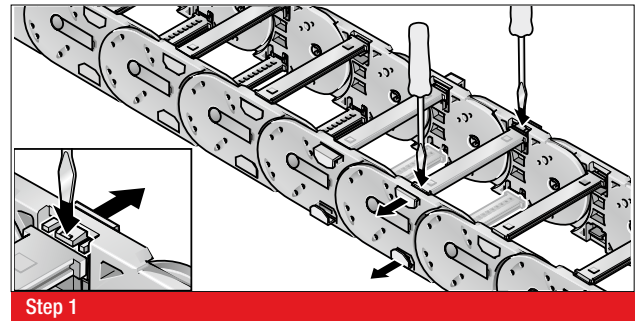
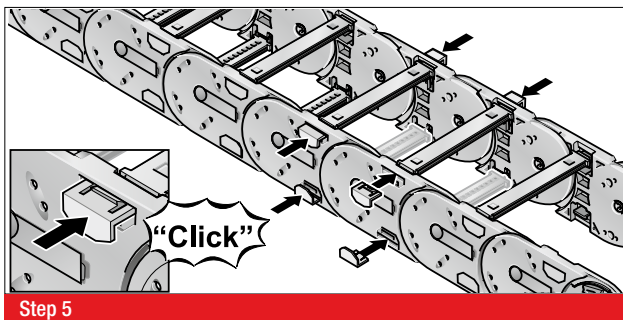
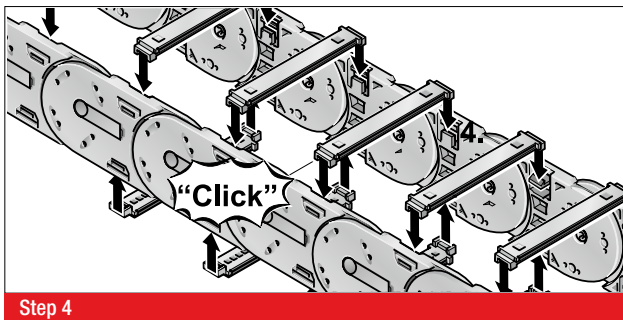
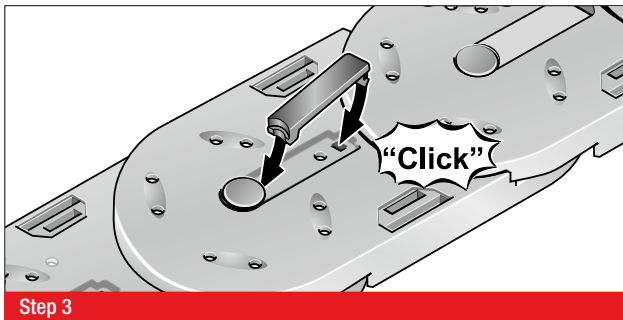
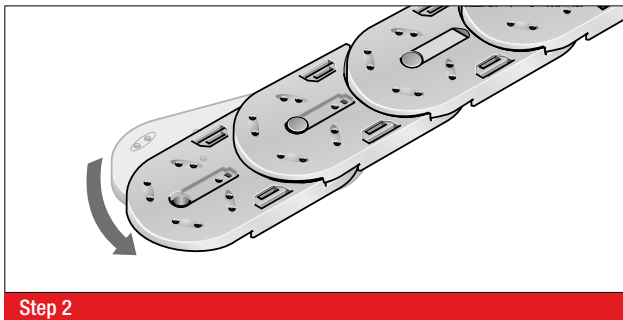
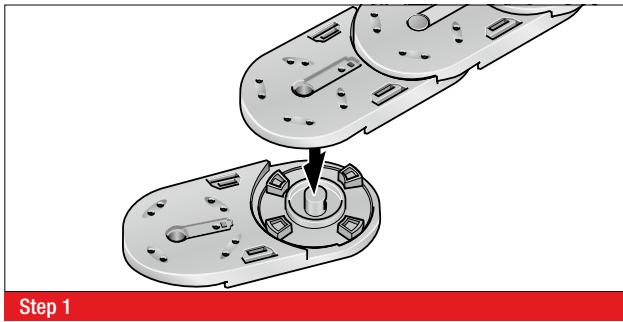

MP 62.4 OPEN



- LOW-COST VARIANT
- SOFT-STOP SYSTEM
- CHAIN BRACKET FLEXIBLE
- BROAD INTERIOR LAYOUT
- PLASTIC OR ALUMINUM VERSION

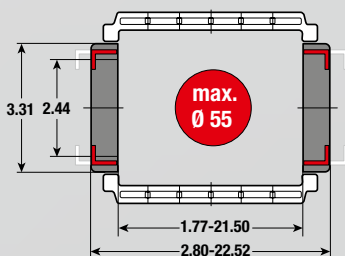

TECHNICAL DATA

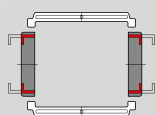

Loading side
Inside and outside bend

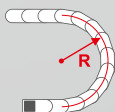

Available radii
5.31 – 11.81 inch

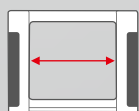

Available interior widths
With plastic crossbar
1.77 – 21.50 inch
With aluminum crossbar / cover
2.64 – 23.62 inch /

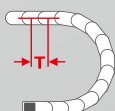

Grid
T = 3.58 inch



Noise attenuator
Reduction of the noise emission by up to 10 dB(A) by the use of damping elements in the chain links.

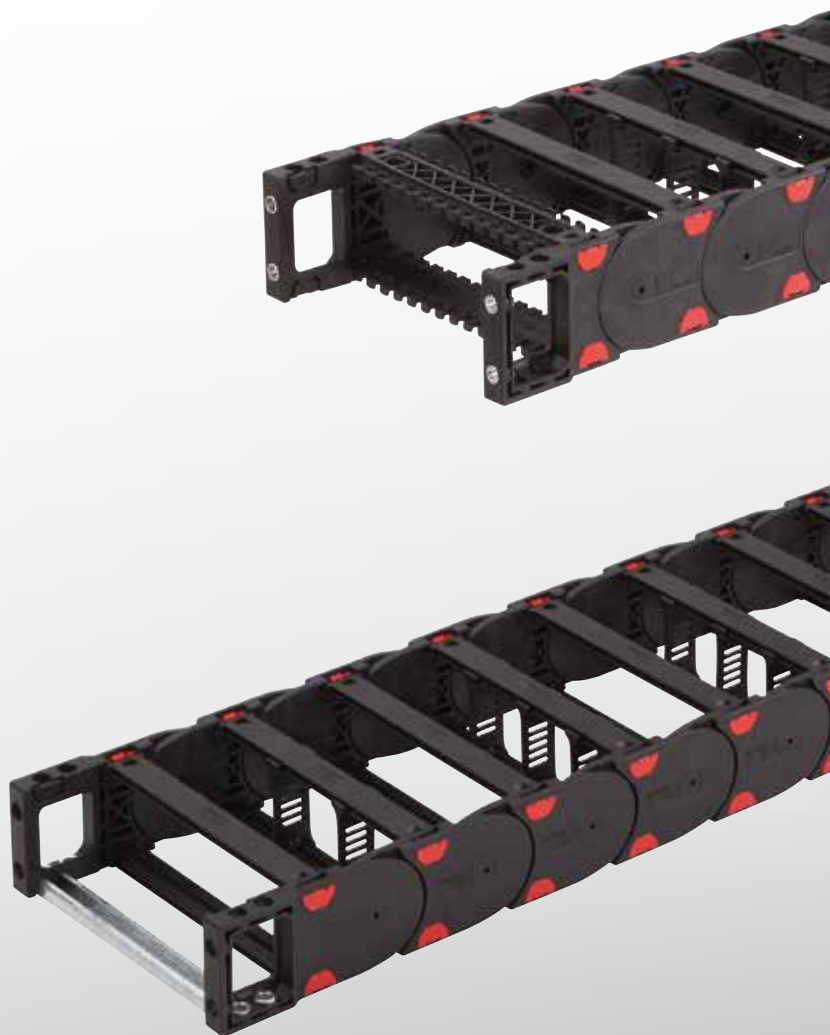



TECHNICAL SPECIFICATIONS

Travel distance gliding L_g max.	164.04 ft.
Travel distance self-supporting L_s max.	see diagram on page 279
Travel distance vertical, hanging L_{vh} max.	164.04 ft.
Travel distance vertical, upright L_{vs} max.	13.12 ft.
Rotated 90°, unsupported L_{90f} max.	3.28 ft.
Speed, gliding V_g max.	16.40 ft/s
Speed, self-supporting V_f max.	65.62 ft/s
Acceleration, gliding a_g max.	82.02 ft/s ²
Acceleration, self-supporting a_s max.	98.43 ft/s ²

Contact our engineering department to meet any higher requirements: efk@murrplastik.de

MATERIAL PROPERTIES

Standard material	Polyamide (PA) black
Service temperature	-22.00 – 248.00 °F
Gliding friction factor	0.30
Static friction factor	0.45
Fire classification	UL 94 HB

Other material properties on request

ACCESSORIES

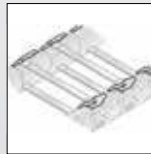

Sliding block

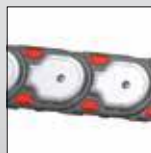

Gliding plate

SHELVING SYSTEM



Separator TR



Bracket bar



RS shelving system



Cover

GUIDE CHANNELS



VAW steel galvanized / stainless steel

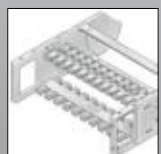

RS-ZL crossbar strain relief

CHAIN BRACKET

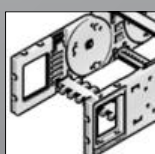

Chain bracket flexible



Crossbar connector RSV

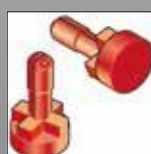

Lock button

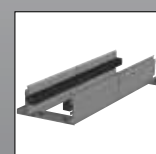

VAW aluminum

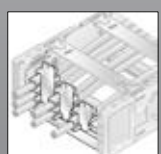

STF Steel Fix

ORDERING KEY

Dimensions in mm [US inch]

Type code	Variation	Inside width	Outside width	Inside width	Outside width	Radius	Rail variant	Material	Chain length
0624 30	Crossbar on outside bend Crossbar on inside bend Opens on inside and outside of bend	045 ¹⁾ [1.77]	071 [2.80]	233 [9.17]	259 [10.20]	135 [5.31]	0 Plastic, full-ridged with bias	2 Polyamide without attenuator (PA/black)	
		057 ¹⁾ [2.24]	083 [3.27]	246 [9.69]	272 [10.71]				
		062 ¹⁾ [2.44]	088 [3.46]	252 [9.92]	278 [10.94]	150 [5.91]	1 Plastic, full-ridged without bias	3 Polyamide with attenuator (PA/black)	
		071 [2.80]	097 [3.82]	258 [10.16]	284 [11.18]				
		084 [3.31]	110 [4.33]	296 [11.65]	322 [12.68]	175 [6.89]	2 Plastic, half-ridged with bias	9 Special version (on request)	
		093 [3.66]	119 [4.69]	346 [13.62]	372 [14.65]				
		096 [3.78]	122 [4.80]	350 [13.78]	376 [14.80]	200 [7.87]	3 Plastic, half-ridged without bias		
		104 [4.09]	130 [5.12]	358 [14.09]	384 [15.12]				
		107 [4.21]	133 [5.24]	371 [14.61]	397 [15.63]	250 [9.84]	4 Aluminum full-ridged with bias		
		121 [4.76]	147 [5.79]	396 [15.59]	422 [16.61]				
		133 [5.24]	159 [6.26]	421 [16.57]	447 [17.60]	300 [11.81]	5 Aluminum full-ridged without bias		
		144 [5.67]	170 [6.69]	446 [17.56]	472 [18.58]				
		146 [5.75]	172 [6.77]	496 [19.53]	522 [20.55]		6 Aluminum half-ridged with bias		
		158 [6.22]	184 [7.24]	546 [21.50]	572 [22.52]				
		164 [6.46]	190 [7.48]				7 Aluminum half-ridged without bias		
		171 [6.73]	197 [7.76]						
		182 [7.17]	208 [8.19]				9 Special version (on request)		
		196 [7.72]	222 [8.74]						
		208 [8.19]	234 [9.21]						
		220 [8.66]	246 [9.69]						

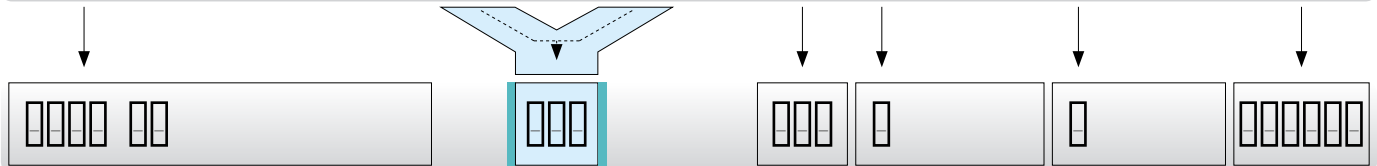

ORDERING EXAMPLE: 0624 30 144 200 0 3 3000

Crossbar on outside bend, crossbar on inside bend, can be opened from inside and outside bend
 Inside width 5.67 in. (144 mm), radius 7.87 in. (200 mm)
 Plastic, full-ridged with bias, material polyamide with damper (PA/black)
 Chain length 118.11 in. (3000 mm) (33 links)

¹⁾ for Variant 30 only

NOTE ON CONFIGURATION

Aluminum crossbars:

Aluminum crossbars can be supplied in 1 mm width sizes for inner widths from 2.64 inch – 23.62 inch.

Crossbar strain relief plate:

If crossbar strain relief plates (RS-ZL) are to be deployed in the chain brackets, take standard inside widths into account.

For detailed information, please consult the corresponding product documentation.

SELF-SUPPORTING LENGTH

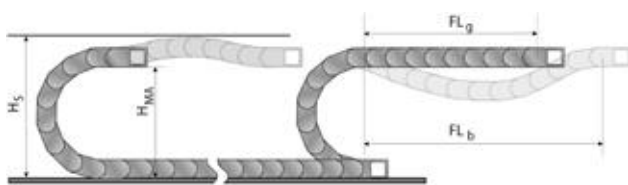

The self-supporting length is the distance between the chain bracket on the moving end and the start of the chain arch. The installation variant FL_g offers the lowest load and wear for the cable drag chain. The maximum travel parameters (speed and acceleration) can be applied for this variant.

- H_s = Installation height plus safety
- H_{MA} = Height of moving end connection
- FL_g = Self-supporting length, upper run straight
- FL_b = Self-supporting length, upper run bent

LOAD DIAGRAM FOR SELF-SUPPORTING APPLICATIONS

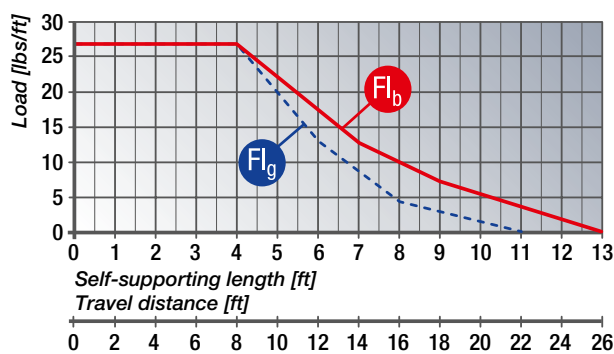

FL_g Self-supporting length, upper run straight

In the FL_g range, the chain upper run still has a bias, is straight or has a maximum sag of 2.76 inch.

FL_b Self-supporting length, upper run bent

In the FL_b range, the chain upper run has a sag of more than 2.76 inch, but this is still less than the maximum sag. Where the sag is greater than that permitted in the FL_b range, the application is critical and should be avoided. The self-supporting length can be optimized by using a support for the upper run or a more stable cable drag chain.

Closed cable drag chains (with covers) have a higher unit weight than open chains (with crossbars). This higher weight must be taken into account when calculating the self-supporting length. To the weight of the cabling (cable load, in lbs/ft (kg/m)), you must add 1.00 lbs/ft (1.5 kg/m), to account for the higher weight of closed-cover chains.

DETERMINING THE CHAIN LENGTH

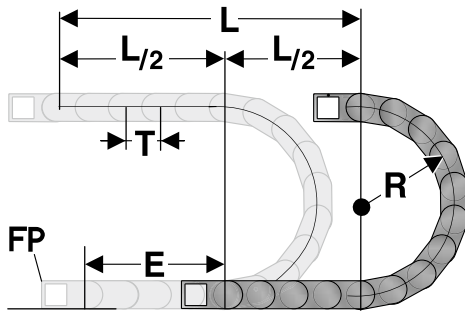

The fixed point of the cable drag chain should be connected in the middle of the travel distance. This arrangement gives the shortest connection between the fixed point (FP) and the moving bracket and thus the most efficient chain length.

Chain length calculation = $L/2 + \pi * R + E$
 $\approx 1 \text{ ft chain} = 4 \text{ qty.} \times 3.58 \text{ inch.}$

- E = Distance between entry point and middle of travel distance
- L = Travel distance
- R = Radius
- P = Grid 3.58 inch

INSTALLATION DIMENSIONS

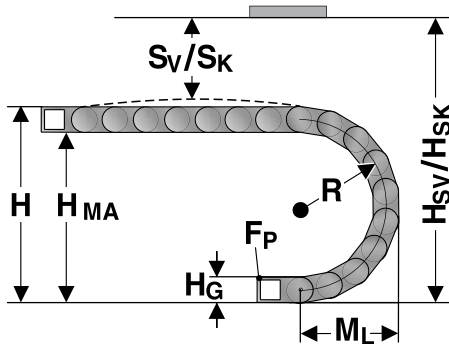

The moving end chain connection is to be screw fixed at height H_{MA} for the respective radius. Concerning the installation dimensions take into consideration, whether the chain links are equipped with damping elements or not. For chain links without damping elements, the value “Installed height with bias H_{sv} without damper” or “Installed height without bias H_{sk} without damper” must be taken into account. If the chain links are equipped with a damping element, the value “Installed height with bias H_{sv} with damper” or “Installed height without bias H_{sk} with damper” is to be taken into account.

Radius R	135	150	175	200	250	300
Outside height of chain link (H_o)	3.31	3.31	3.31	3.31	3.31	3.31
Height of bend (H)	273.31	303.31	353.31	403.31	503.31	603.31
Height of moving end connection (H_{MA})	270.00	300.00	350.00	400.00	500.00	600.00
Safety margin with bias (S_v)	0.79	0.79	0.79	0.79	0.79	0.79
Installation height with bias (H_{sv}) without damper	276.46	306.46	356.46	406.46	506.46	606.46
Installation height with bias (H_{sv}) with damper	277.64	307.64	357.64	407.64	507.64	607.64
Safety margin without bias (S_k)	0.79	0.79	0.79	0.79	0.79	0.79
Installation height without bias (H_{sk}) without damper	274.10	304.10	354.10	404.10	504.10	604.10
Installation height without bias (H_{sk}) with damper	275.28	305.28	355.28	405.28	505.28	605.28
Arc projection (M_L)	140.24	155.24	180.24	205.24	255.24	305.23

DAMPING ELEMENTS FOR THE SIDE LINKS

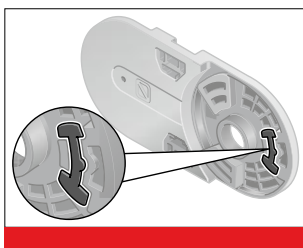

The dampening elements in the stops make for a significantly quieter unrolling of the chain links. The dampers can be chosen optionally. A reduction of the noise emission by up to 10 dB(A) comparing to the variants without the use of damping elements is possible.

POWERLINE PLASTIC CROSSBAR



The crossbars connect the two side runs of the cable drag chain. The crossbar length is synonymous with the inside width of the cable drag chain.

Type	Order No.	Description	Inside width inch
BS 045-5	052004500000	Crossbar	1.77
BS 057-5	052005700000	Crossbar	2.24
BS 062-5	052006200000	Crossbar	2.44
BS 071-5	052007100000	Crossbar	2.80
BS 084-5	052008400000	Crossbar	3.31
BS 093-5	052009300000	Crossbar	3.66
BS 096-5	052009600000	Crossbar	3.78
BS 104-5	052010400000	Crossbar	4.09
BS 107-5	052010700000	Crossbar	4.21
BS 121-5	052012100000	Crossbar	4.76
BS 133-5	052013300000	Crossbar	5.24
BS 144-5	052014400000	Crossbar	5.67
BS 146-5	052014600000	Crossbar	5.75
BS 158-5	052015800000	Crossbar	6.22
BS 164-5	052016400000	Crossbar	6.46
BS 171-5	052017100000	Crossbar	6.73
BS 182-5	052018200000	Crossbar	7.17
BS 196-5	052019600000	Crossbar	7.72
BS 208-5	052020800000	Crossbar	8.19
BS 220-5	052022000000	Crossbar	8.66
BS 233-5	052023300000	Crossbar	9.17
BS 246-5	052024600000	Crossbar	9.69
BS 252-5	052025200010	Crossbar	9.92
BS 258-5	052025800000	Crossbar	10.16
BS 296-5	052029600000	Crossbar	11.65
BS 346-5	052034600000	Crossbar	13.62
BS 350-5	052035000000	Crossbar	13.78
BS 358-5	052035800000	Crossbar	14.09
BS 371-5	052037100000	Crossbar	14.61
BS 396-5	052039600000	Crossbar	15.59
BS 421-5	052042100000	Crossbar	16.57
BS 446-5	052044600000	Crossbar	17.56
BS 496-5	052049600000	Crossbar	19.53
BS 546-5	052054600000	Crossbar	21.50

KA 62.4 CHAIN BRACKET FLEXIBLE

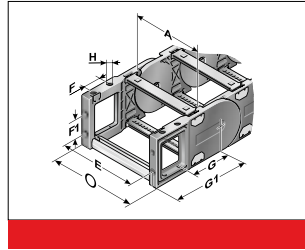
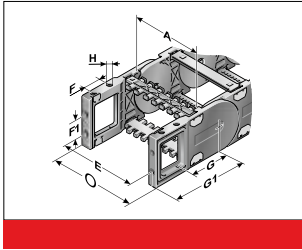

This chain bracket offers universal connection options (top, bottom and front) and is attached to the ends of the chain like a side link. This allows the chain to move right up to the bracket. Each chain requires one male and one female bracket. M8 screws are used to secure the brackets in place. Pressed-in metal bushes with a through-hole ensure the permanent, high-strength transmission of even extreme forces onto the cable drag chain.

Type	Order No.	Material	Version	Inside width								Outside width of KA 01
				A inch	E inch	F inch	F1 inch	G inch	G1 inch	H inch	HØ inch	
KA 62.4-FB Female end	0624000050	Plastic	with bush	1.77 – 21.50	A+0.63	0.79	1.77	3.35	4.92	0.35	A+1.34	
KA 62.4-FB male end	0624000051	Plastic	with bush	1.77 – 21.50	A+0.63	0.79	1.77	3.35	4.92	0.35	A+1.34	
KA 62.4-FB Female end, pendular	0624000052	Plastic	with bush	1.77 – 21.50	A+0.63	0.79	1.77	3.35	4.92	0.35	A+1.34	
KA 62.4-FG female end	0624000053	Plastic	with thread	1.77 – 21.50	A+0.63	0.79	1.77	3.35	4.92	M8	A+1.34	
KA 62.4-FG Female end, pendular	0624000055	Plastic	with thread	1.77 – 21.50	A+0.63	0.79	1.77	3.35	4.92	M8	A+1.34	
KA 62.4-FG male end	0624000054	Plastic	with thread	1.77 – 21.50	A+0.63	0.79	1.77	3.35	4.92	M8	A+1.34	

GS 62.4 SLIDING BLOCK

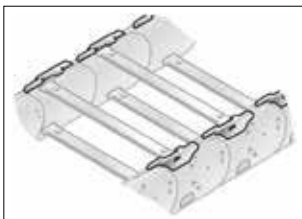

Sliding block

In the case of cable drag chains, sliding blocks are used in a horizontally sliding installation mode (the tight side of the chain slides on the slack side). The sliding blocks are set onto the side links on the interior bend instead of the usual crossbar interlocks; (no tools needed). This forces the chain to slide on the sliding blocks instead on the side links of the chain.

Depending on the application, the service life of the cable drag chain may be extended five-fold, by using slide blocks.

Information about the minimum bending radius of the cable drag chain at the sliding block insert is listed in the following table.

Type	Order No.	Installation site	Min. radius inch	Sliding block height inch
GS 62.4.1 right	062490400302	For right side link	6.89	0.16
GS 62.4.2 left	062490400300	For left side link	6.89	0.16

GLP 5 (62.4) GLIDING PLATE

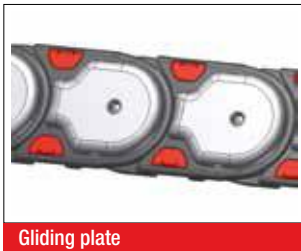

The gliding plates are mounted in a horizontal position, with the chain laying on its side, to minimize friction wear to the sides. They are mounted to the side links using a special screw. The wear limit is 0.1 in (2.5 mm). We recommend replacing the cable drag chain when this limit has been reached. Depending on the application, the service life of the cable drag chain may be extended two-fold, by using gliding plates. The cable drag chain must be placed on its side before opening.

Type	Order No.	Installation site	for radius inch	Gliding plate height inch
SG 62.4 RK135.1 right with GLP5, mounted	062400013566	Right chain link including gliding plate	5.31	0.28
SG 62.4 RK135.2 left with GLP5, mounted	062400013564	Left chain link including gliding plate	5.31	0.28
SG 62.4 RK150.1 right with GLP5, mounted	062400015066	Right chain link including gliding plate	5.91	0.28
SG 62.4 RK150.2 left with GLP5, mounted	062400015064	Left chain link including gliding plate	5.91	0.28
SG 62.4 RK175.1 right with GLP5, mounted	062400017566	Right chain link including gliding plate	6.89	0.28
SG 62.4 RK175.2 left with GLP5, mounted	062400017564	Left chain link including gliding plate	6.89	0.28
SG 62.4 RK200.1 right with GLP5, mounted	062400020066	Right chain link including gliding plate	7.87	0.28
SG 62.4 RK200.2 left with GLP5, mounted	062400020064	Left chain link including gliding plate	7.87	0.28
SG 62.4 RK250.1 right with GLP5, mounted	062400025066	Right chain link including gliding plate	9.84	0.28
SG 62.4 RK250.2 left with GLP5, mounted	062400025064	Left chain link including gliding plate	9.84	0.28
SG 62.4 RK300.1 right with GLP5, mounted	062400030066	Right chain link including gliding plate	11.81	0.28
SG 62.4 RK300.2 left with GLP5, mounted	062400030064	Left chain link including gliding plate	11.81	0.28
SG 62.4-D RK135.1 right with GLP5, mounted	062400013596	Right chain link including gliding plate	5.31	0.28
SG 62.4-D RK135.2 left with GLP5, mounted	062400013594	Left chain link including gliding plate	5.31	0.28
SG 62.4-D RK150.1 right with GLP5, mounted	062400015096	Right chain link including gliding plate	5.91	0.28
SG 62.4-D RK150.2 left with GLP5, mounted	062400015094	Left chain link including gliding plate	5.91	0.28
SG 62.4-D RK175.1 right with GLP5, mounted	062400017596	Right chain link including gliding plate	6.89	0.28
SG 62.4-D RK175.2 left with GLP5, mounted	062400017594	Left chain link including gliding plate	6.89	0.28
SG 62.4-D RK200.1 right with GLP5, mounted	062400020096	Right chain link including gliding plate	7.87	0.28
SG 62.4-D RK200.2 left with GLP5, mounted	062400020094	Left chain link including gliding plate	7.87	0.28
SG 62.4-D RK250.1 right with GLP5, mounted	062400025096	Right chain link including gliding plate	9.84	0.28
SG 62.4-D RK250.2 left with GLP5, mounted	062400025094	Left chain link including gliding plate	9.84	0.28
SG 62.4-D RK300.1 right with GLP5, mounted	062400030096	Right chain link including gliding plate	11.81	0.28
SG 62.4-D RK300.2 left with GLP5, mounted	062400030094	Left chain link including gliding plate	11.81	0.28

TR 62.4 SEPARATOR

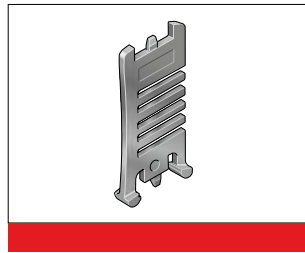
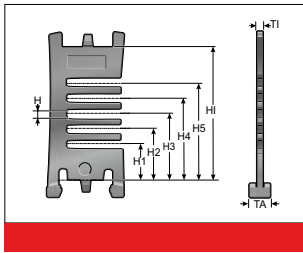

We recommend that separators be used if multiple round cables or conduits with differing diameters are to be installed.

Type	Order No.	Description	Version	TI inch	TA inch	H inch	H1 inch	H2 inch	H3 inch	H4 inch	H5 inch	HI inch
TR 62.4	062400009200	TR 62.4 Separator	lockable	0.14	0.43	0.16	0.67	0.94	1.22	1.50	1.77	2.44

TR 62.4-V SEPARATOR

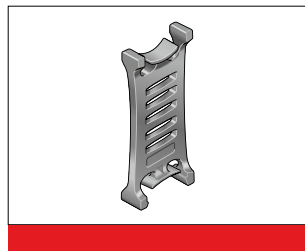
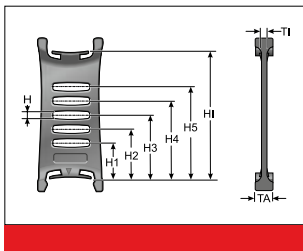

We recommend that separators be used if multiple round cables or conduits with differing diameters are to be installed.

Type	Order No.	Description	Version	TI inch	TA inch	H inch	H1 inch	H2 inch	H3 inch	H4 inch	H5 inch	HI inch
TR 62.4-V	062400009300	TR 62.4-V Separator	movable	0.14	0.51	0.16	0.67	0.94	1.22	1.50	1.77	2.44

RTT 62.4 SHELF SUPPORT, DIVISIBLE

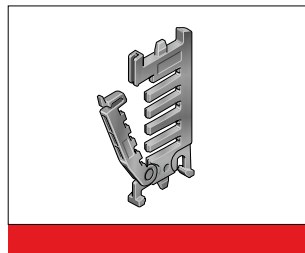
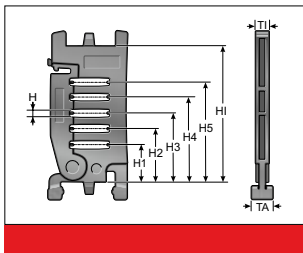

In connection with two separable shelf supports (RTT) with at least one end-to-end shelf (RB) the shelf becomes an easy to fill shelving system. The additional levels prevent cables from criss-crossing and minimize the friction between them.

Type	Order No.	Description	Version	TI inch	TA inch	H inch	H1 inch	H2 inch	H3 inch	H4 inch	H5 inch	HI inch
RTT 62.4	100090624000	Shelf support, divisible	lockable	0.28	0.43	0.16	0.67	0.94	1.22	1.50	1.77	2.44

RSV 62.4 CROSSBAR CONNECTOR



For crossbars wider than 9.69 inch (246 mm), we recommend the use of crossbar connectors. These prevent deformation to the crossbar under large amounts of additional weight of the chain assembly.

Order No.	Description	TI inch
062400009700	Crossbar connector	0.24
062400009800	Crossbar connector for aluminum crossbars	0.24

RB-5 SHELF

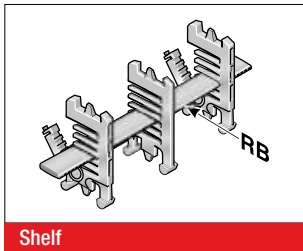

In connection with at least two separable shelf supports (RTT), the shelf becomes a shelving system. The additional levels prevent cables from criss-crossing and minimize the friction between them.

Type	Order No.	Description	Width inch	Inside width inch
RB 028-5	10000002800	Shelf	1.10	1.77
RB 034-5	1000003405	Shelf	1.32	1.77
RB 039-5	1000003905	Shelf	1.54	1.77
RB 045-5	1000004505	Shelf	1.76	2.24
RB 050-5	1000005005	Shelf	1.98	2.24
RB 056-5	10000005601	Shelf	2.20	2.44
RB 062-5	1000006205	Shelf	2.43	2.44
RB 067-5	1000006705	Shelf	2.65	3.31
RB 073-5	1000007305	Shelf	2.87	3.31
RB 078-5	1000007805	Shelf	3.09	3.31
RB 084-5	10000008400	Shelf	3.31	3.31
RB 090-5	1000009005	Shelf	3.53	3.78
RB 095-5	1000009505	Shelf	3.75	3.78
RB 101-5	1000010105	Shelf	3.97	4.21
RB 106-5	1000010605	Shelf	4.19	4.21
RB 112-5	100000011200	Shelf	4.41	4.76
RB 118-5	1000011805	Shelf	4.63	4.76
RB 123-5	1000012305	Shelf	4.85	5.24
RB 129-5	1000012905	Shelf	5.07	5.24
RB 134-5	1000013405	Shelf	5.29	5.67
RB 140-5	100000014000	Shelf	5.51	5.67
RB 146-5	1000014605	Shelf	5.73	6.22
RB 151-5	1000015105	Shelf	5.95	6.22
RB 157-5	1000015705	Shelf	6.17	6.46
RB 162-5	1000016205	Shelf	6.39	6.46
RB 168-5	100000016800	Shelf	6.61	7.17
RB 174-5	1000017405	Shelf	6.83	7.17
RB 179-5	1000017905	Shelf	7.06	7.72
RB 185-5	1000018505	Shelf	7.28	7.72
RB 190-5	1000019005	Shelf	7.50	7.72
RB 196-5	100000019600	Shelf	7.72	7.72
RB 291-5	100000029100	Shelf	11.46	13.62

BS-5 BRACKET BAR



Large-diameter conduits are routed securely by using bracket bars (BS). This bar is installed on the crossbars or the covers of the cable drag chain. The bracket bar can be installed on both the inside and outside bend.

The bracket bar support (BSH) is used to attach the bars to PowerLine series crossbars. Two bracket bar supports are required for each bar.

Type	Order No.	Description	Conduit diameter max. inch	Installation height inch	Inner chain width min. inch
BS 120-5	052412000000	Bracket bar	4.53	5.51	6.46
BS 153-5	052415300000	Bracket bar	5.83	6.69	8.19
BS 187-5	052418700000	Bracket bar	7.17	8.07	9.17
BSH-5	052400000000	Bracket bar support			
Assembly set	052400000001	Assembly set			

D5 CHAIN BRACKET COVER

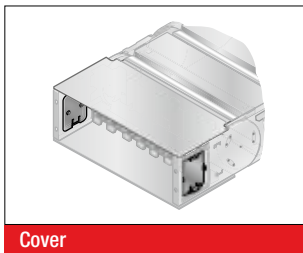

Self-locking covers close the side mounting window on the flexible chain bracket (KA-FB/FG).

Type	Order No.
D5 Cover	0523888002

RS-ZL-5 CROSSBAR STRAIN RELIEF PLATE

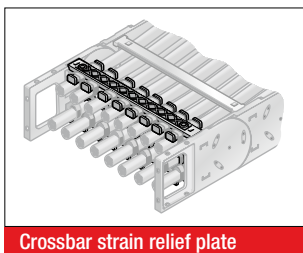

Fixed integrated crossbar strain relief plates in the chain brackets. Tailored to all crossbar widths up to 9.69 inch (246 mm). May be assembled on the inside and outside bends at both chain endings.

Type	Order No.	Description	Inside width inch
RS-ZL 045-5	052004500010	Crossbar strain relief plate	1.77
RS-ZL 057-5	052005700010	Crossbar strain relief plate	2.24
RS-ZL 062-5	052006200010	Crossbar strain relief plate	2.44
RS-ZL 071-5	052007100010	Crossbar strain relief plate	2.80
RS-ZL 084-5	052008400010	Crossbar strain relief plate	3.31
RS-ZL 093-5	052009300010	Crossbar strain relief plate	3.66
RS-ZL 096-5	052009600010	Crossbar strain relief plate	3.78
RS-ZL 104-5	052010400010	Crossbar strain relief plate	4.09
RS-ZL 107-5	052010700010	Crossbar strain relief plate	4.21
RS-ZL 121-5	052012100010	Crossbar strain relief plate	4.76

RS-ZL-5 CROSSBAR STRAIN RELIEF PLATE

Type	Order No.	Description	Inside width inch
RS-ZL 133-5	052013300010	Crossbar strain relief plate	5.24
RS-ZL 144-5	052014400010	Crossbar strain relief plate	5.67
RS-ZL 146-5	052014600010	Crossbar strain relief plate	5.75
RS-ZL 158-5	052015800010	Crossbar strain relief plate	6.22
RS-ZL 164-5	052016400010	Crossbar strain relief plate	6.46
RS-ZL 171-5	052017100010	Crossbar strain relief plate	6.73
RS-ZL 182-5	052018200010	Crossbar strain relief plate	7.17
RS-ZL 196-5	052019600010	Crossbar strain relief plate	7.72
RS-ZL 208-5	052020800010	Crossbar strain relief plate	8.19
RS-ZL 220-5	052022000010	Crossbar strain relief plate	8.66
RS-ZL 233-5	052023300010	Crossbar strain relief plate	9.17
RS-ZL 246-5	052024600010	Crossbar strain relief plate	9.69

STRAIN RELIEF WITH STEEL FIX

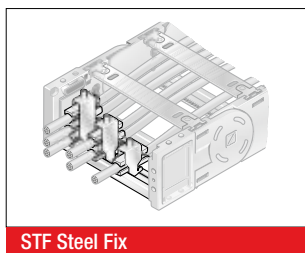
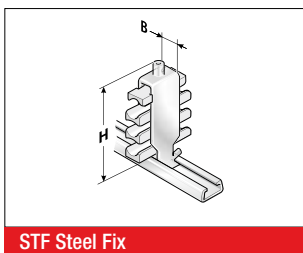

C-rails (galvanized) for permanent integration, for accommodating the Steel Fix bow clamps in the chain brackets. The bow clamps can take up to 3 cables and are suitable for C-rails with a groove width of 0.43 in (11 mm). Due to the design of the trough elements, a cable preserving cable guidance is ensured. May be assembled on the inside and outside bends at both chain endings. The overall height stated is a guide only. The actual height is, amongst other things, dependent on the diameter and the quality of the cable. A safety distance of 0.39 in (10 mm) at the fixed point above the strain relief must be kept during gliding applications.

Type	Part number	Description	Seats qty.	Cable Ø inch	Width (B) inch	Total height (H) inch
Single clamp (for one cable)						
STF 12-1 Steel Fix	81661801	Hooped clamp	1	0.24 – 0.47	0.63	2.17
STF 14-1 Steel Fix	81661802	Hooped clamp	1	0.47 – 0.55	0.71	2.05
STF 16-1 Steel Fix	81661803	Hooped clamp	1	0.55 – 0.63	0.79	2.13
STF 18-1 Steel Fix	81661804	Hooped clamp	1	0.63 – 0.71	0.87	2.20
STF 20-1 Steel Fix	81661805	Hooped clamp	1	0.71 – 0.79	0.94	2.32
STF 22-1 Steel Fix	81661806	Hooped clamp	1	0.79 – 0.87	1.02	2.40
STF 26-1 Steel Fix	81661807	Hooped clamp	1	0.87 – 1.02	1.18	2.76
STF 30-1 Steel Fix	81661808	Hooped clamp	1	1.02 – 1.18	1.34	2.91
STF 34-1 Steel Fix	81661809	Hooped clamp	1	1.18 – 1.34	1.50	3.07
STF 38-1 Steel Fix	81661810	Hooped clamp	1	1.34 – 1.50	1.65	3.23
STF 42-1 Steel Fix	81661811	Hooped clamp	1	1.50 – 1.65	1.81	3.58
Double clamp (for two cables)						
STF 12-2 Steel Fix	81661821	Hooped clamp	2	0.24 – 0.47	0.63	2.87
STF 14-2 Steel Fix	81661822	Hooped clamp	2	0.47 – 0.55	0.71	2.91
STF 16-2 Steel Fix	81661823	Hooped clamp	2	0.55 – 0.63	0.79	3.23
STF 18-2 Steel Fix	81661824	Hooped clamp	2	0.63 – 0.71	0.87	3.39
STF 20-2 Steel Fix	81661825	Hooped clamp	2	0.71 – 0.79	0.94	3.58
STF 22-2 Steel Fix	81661826	Hooped clamp	2	0.79 – 0.87	1.02	3.74
STF 26-2 Steel Fix	81661827	Hooped clamp	2	0.87 – 1.02	1.18	4.25
STF 30-2 Steel Fix	81661828	Hooped clamp	2	1.02 – 1.18	1.34	4.76
STF 34-2 Steel Fix	81661829	Hooped clamp	2	1.18 – 1.34	1.50	5.08
Triple clamp (for three cables)						
STF 12-3 Steel Fix	81661841	Hooped clamp	3	0.24 – 0.47	0.63	3.86

STRAIN RELIEF WITH STEEL FIX

Type	Part number	Description	Seats qty.	Cable Ø inch	Width (B) inch	Total height (H) inch
STF 14-3 Steel Fix	81661842	Hooped clamp	3	0.47 – 0.55	0.71	3.86
STF 16-3 Steel Fix	81661843	Hooped clamp	3	0.55 – 0.63	0.79	4.13
STF 18-3 Steel Fix	81661844	Hooped clamp	3	0.63 – 0.71	0.87	4.37
STF 20-3 Steel Fix	81661845	Hooped clamp	3	0.71 – 0.79	0.94	4.65
STF 22-3 Steel Fix	81661846	Hooped clamp	3	0.79 – 0.87	1.02	5.12

MP 52/62/72 LOCK BUTTON

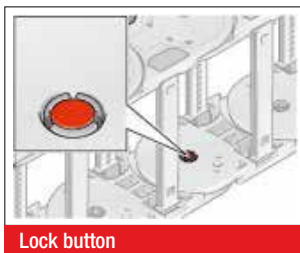

Lock button

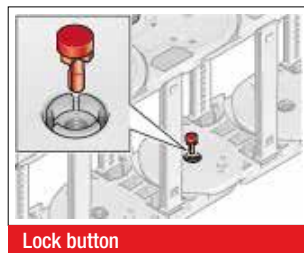

Lock button

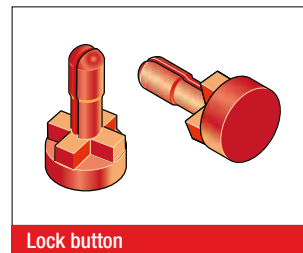

Lock button

To increase the side stability we recommend the use of lock buttons during strong lateral acceleration or when installed “laying

on the side (turned 90°) without support”.

Type	Part number
MP52/62/72 lock button	0520000080

MP 62.4 LOWERED FIXING POINT

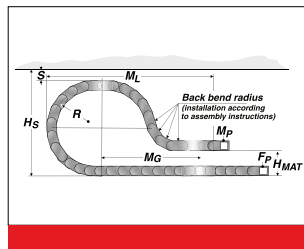
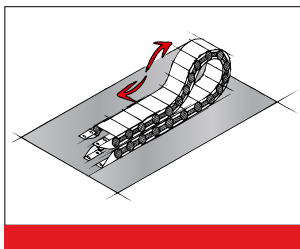

It is sometimes necessary to lower the height of the moving attachment point.

In such cases, modifications to the chain layout should be noted (e.g. extension of chain).

Please contact our application engineers.

Radius R inch	Height of moving end connection (H _{MA}) inch	Safety margin (S) inch	Installation height incl. safety (h _i) inch	Projection (M ₁) inch	Additional links qty.	of which additional back chain links qty.
6.89	7.09	1.97	19.06	24.41	6	3
7.87	8.27	1.97	21.02	32.68	10	3
9.84	9.84	1.97	24.96	38.98	13	3
11.81	11.81	1.97	28.90	35.43	14	3

MP 62.4 REARWARD RADII

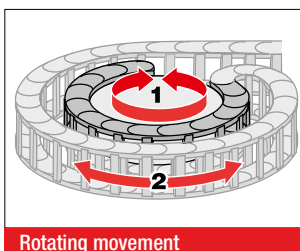

Rotating movement

Side links with forward radius (R) and rearward radius (R_ü) allow movements in both directions. This is intended for rotating movements and lowered chain brackets. Note: This type of chain has different chain links for the left or right side! Rotation movements are only possible with open variants.

Type	Part number	Radius inch	Back radius inch
SR 62.4 (RÜ200/R150.2) left	062400015060	5.91	7.87
SR 62.4 (RÜ200/R150.1) right	062400015062	5.91	7.87
SR 62.4 (RÜ200/R200.2) left	062400020060	7.87	7.87
SR 62.4 (RÜ200/R200.1) right	062400020062	7.87	7.87

GUIDE CHANNEL VAW (ALUMINUM / STAINLESS STEEL)



A range of variable guide channel systems, constructed from aluminum or stainless steel sections, is available for this cable drag chain.

The variable guide channel ensures that the cable drag chain is supported and guided securely.

ASSEMBLY

DISASSEMBLY

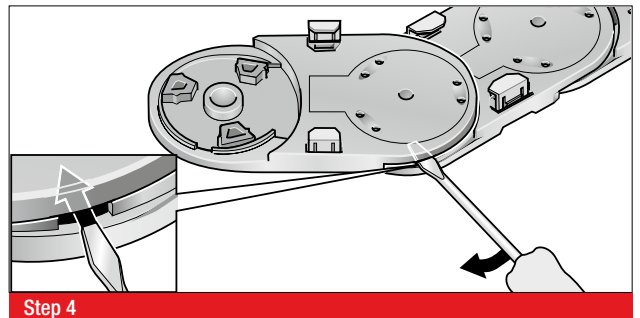
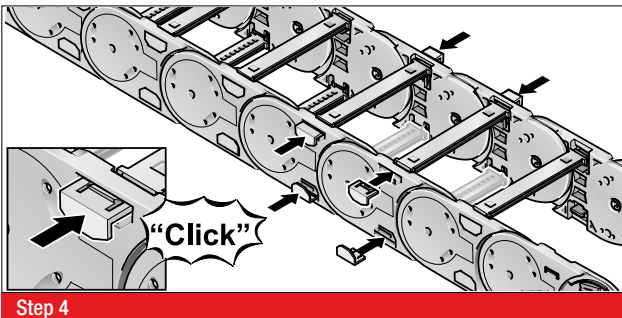
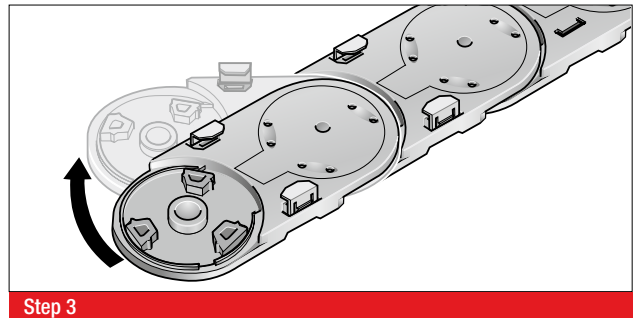
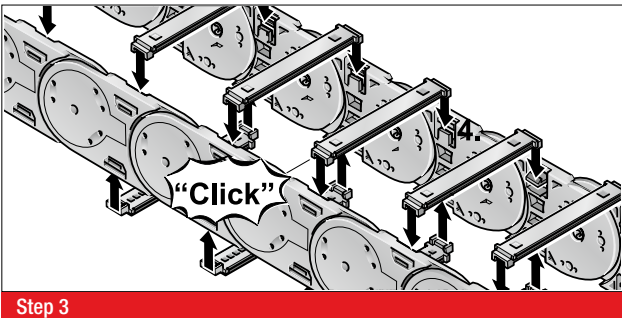
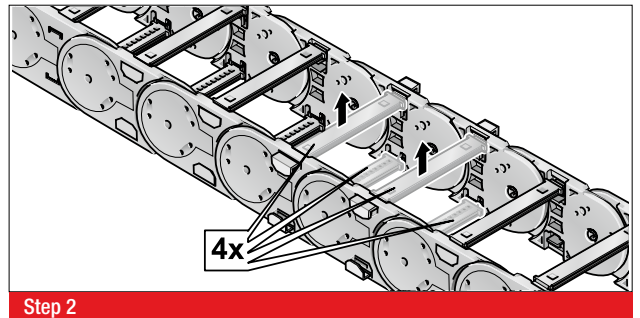
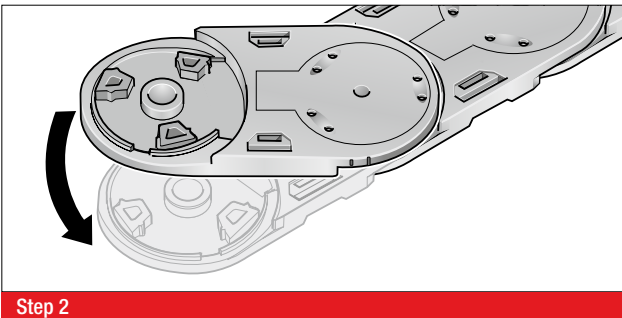
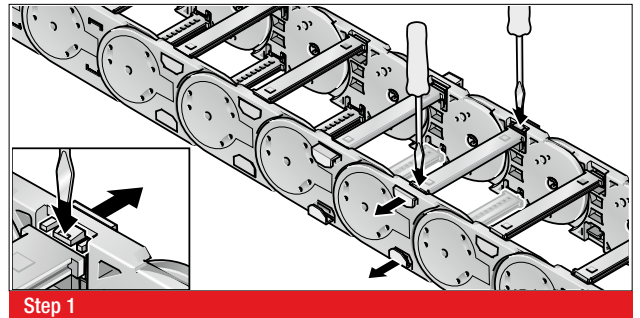
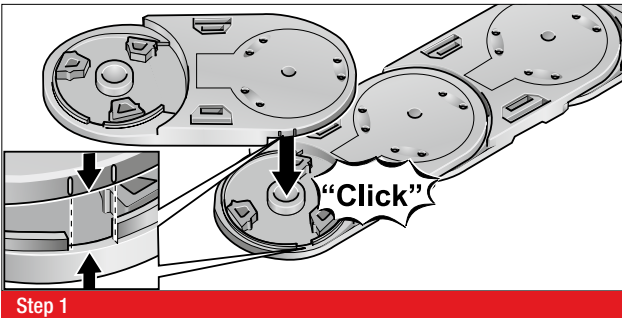

MP 62.2 OPEN



MP 62.3 CLOSED



- SLIDING BLOCKS FOR LONGER SERVICE LIFE
- BROAD INTERIOR LAYOUT
- CHAIN BRACKET FLEXIBLE
- PLASTIC OR ALUMINUM VERSION

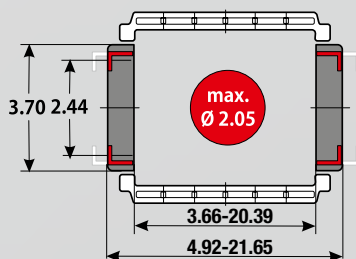

TECHNICAL DATA

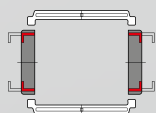

Loading side
Inside and outside bend

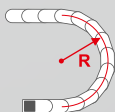

Available radii
5.91 – 19.69 inch

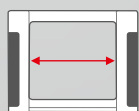

Available interior widths
With plastic crossbar
3.66 – 20.39 inch
With aluminum crossbar / cover
2.83 – 23.62 inch / 1.57 – 23.62 inch

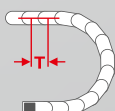

Grid
T = 3.94 inch

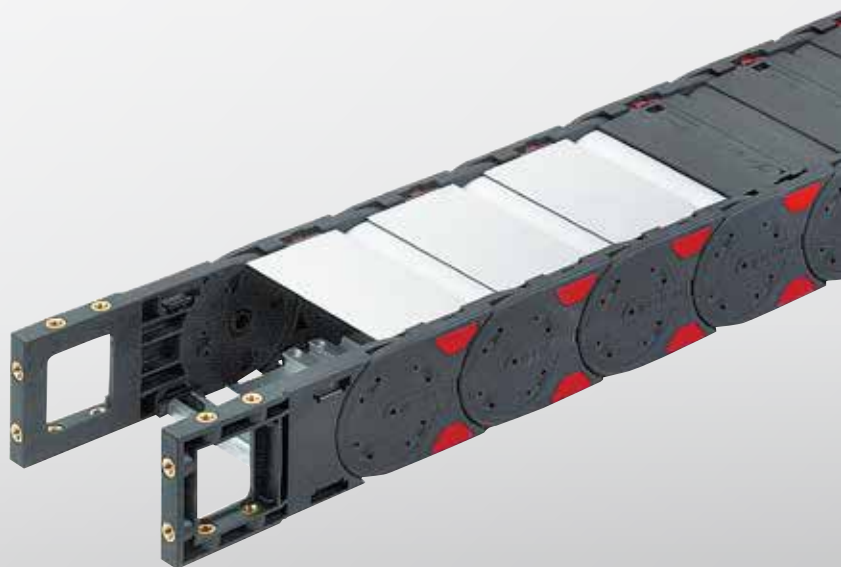
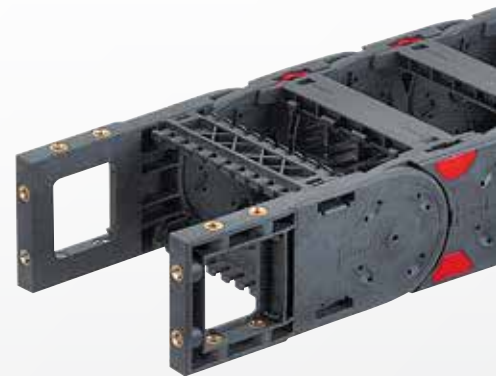



TECHNICAL SPECIFICATIONS

Travel distance gliding L_g max.	492.13 ft.
Travel distance self-supporting L_s max.	see diagram on page 293
Travel distance vertical, hanging L_{vh} max.	213.25 ft.
Travel distance vertical, upright L_{vs} max.	19.69 ft.
Rotated 90°, unsupported L_{90f} max.	13.12 ft.
Speed, gliding V_g max.	16.40 ft/s
Speed, self-supporting V_f max.	65.62 ft/s
Acceleration, gliding a_g max.	82.02 ft/s ²
Acceleration, self-supporting a_f max.	131.23 ft/s ²

Contact our engineering department to meet any higher requirements: efk@murrplastik.de

MATERIAL PROPERTIES

Standard material	Polyamide (PA) black
Service temperature	-22.00 – 248.00 °F
Gliding friction factor	0.30
Static friction factor	0.45
Fire classification	UL 94 HB

Other material properties on request

ACCESSORIES



Sliding block

SHELVING SYSTEM



Separator TR



Bracket bar

CHAIN BRACKET

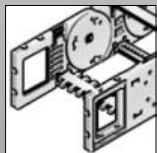

Chain bracket flexible

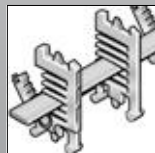

RS shelving system



Cover

GUIDE CHANNELS



VAW steel galvanized / stainless steel



RS-ZL crossbar strain relief

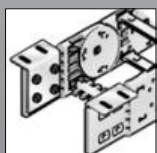

Chain bracket angle



Crossbar connector RSV

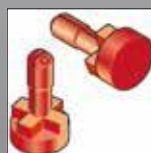

Lock button

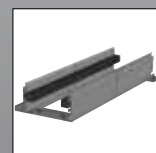

VAW aluminum

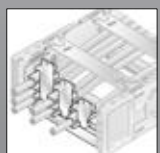

STF Steel Fix

ORDERING KEY

Dimensions in mm [US inch]

Type code	Variation	Inside width	Outside width	Inside width	Outside width	Radius	Rail variant	Material	Chain length
0622 30	MP 62.2 open Crossbar on outside bend Crossbar on inside bend Opens on inside and outside of bend	093 [3.66]	125 [4.92]	468 [18.43]	500 [19.69]	150¹⁾ [5.91]	0 Plastic, full-ridged with bias	0 Polyamide (PA): standard (PA/black)	
		106 [4.17]	138 [5.43]	518 [20.39]	550 [21.65]				
0623 44	MP 62.3 closed Cover on outside of bend Cover on inside of bend Opens on inside and outside of bend	118²⁾ [4.65]	150 [5.91]			200 [7.87]	1 Plastic, full-ridged without bias	5 Polypropylene (PP/blue)	
		131 [5.16]	163 [6.42]						
		143²⁾ [5.63]	175 [6.89]			250 [9.84]	2 Plastic, half-ridged with bias	7 ESD (PA/light gray)	
		156 [6.14]	188 [7.40]						
		168 [6.61]	200 [7.87]			300 [11.81]	3 Plastic, half-ridged without bias	9 Special version (on request)	
		181 [7.13]	213 [8.39]						
		193²⁾ [7.60]	225 [8.86]			350 [13.78]	4 Aluminum full-ridged with bias		
		206 [8.11]	238 [9.37]						
		218 [8.58]	250 [9.84]			400 [15.75]	5 Aluminum full-ridged without bias		
		231 [9.09]	263 [10.35]						
		243²⁾ [9.57]	275 [10.83]			500 [19.69]	6 Aluminum half-ridged with bias		
		256 [10.08]	288 [11.34]						
		268 [10.55]	300 [11.81]				7 Aluminum half-ridged without bias		
		293²⁾ [11.54]	325 [12.80]						
		318 [12.52]	350 [13.78]				9 Special version (on request)		
		343²⁾ [13.50]	375 [14.76]						
		368 [14.49]	400 [15.75]						
		418²⁾ [16.46]	450 [17.72]						

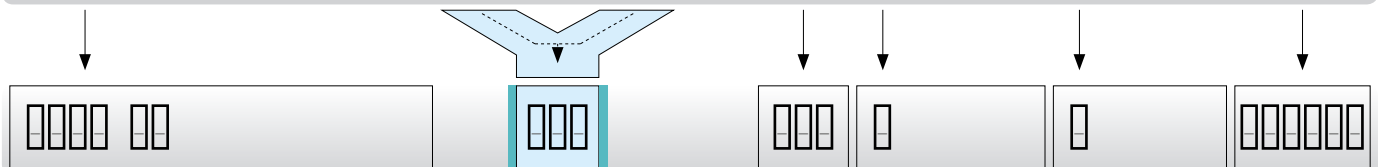

ORDERING EXAMPLE: 0622 118 150 0 0 00062

Crossbar on outside bend, crossbar on inside bend, can be opened from inside and outside bend
 Inside width 4.65 in.; radius 5.91 in.
 Plastic crossbar, full-ridged with bias, material black-colored polyamide
 Chain length 62 in. (16 links)

¹⁾ for Variant 30 only
²⁾ also available with plastic cover

NOTE ON CONFIGURATION

Aluminum crossbars:

Aluminum crossbars in 0.04 in (1 mm) width sizes for inner widths from 2.83 inch – 23.62 inch are available for delivery.

Aluminum covers:

Aluminum covers in 0.04 in (1 mm) width sizes for inner widths from 1.57 inch – 23.62 inch are available for delivery.

Crossbar connector and crossbar strain relief plate:

Once inside widths exceed 9.69 inches (243 mm), we recommend the deployment of crossbar connectors (RSV). Crossbar connectors cannot be used in conjunction with covers made from plastic or aluminum.

If crossbar strain relief plates (RS-ZL) are to be deployed in the chain brackets, take standard inside widths into account.

For detailed information, please consult the corresponding product documentation.

SELF-SUPPORTING LENGTH

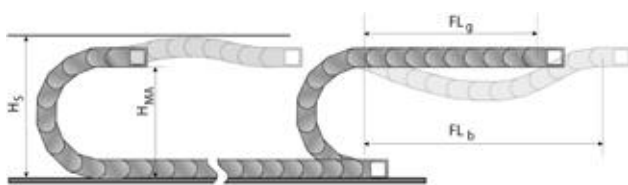

The self-supporting length is the distance between the chain bracket on the moving end and the start of the chain arch.

The installation variant FL_g offers the lowest load and wear for the cable drag chain.

The maximum travel parameters (speed and acceleration) can be applied for this variant.

H_s = Installation height plus safety

H_{MA} = Height of moving end connection

FL_g = Self-supporting length, upper run straight

FL_b = Self-supporting length, upper run bent

LOAD DIAGRAM FOR SELF-SUPPORTING APPLICATIONS

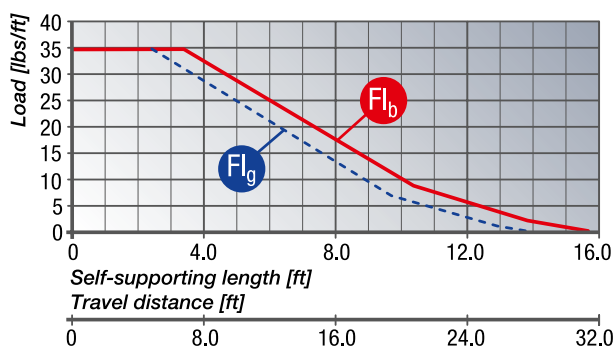

FL_g Self-supporting length, upper run straight

In the FL_g range, the chain upper run still has a bias, is straight or has a maximum sag of 3.15 inch.

FL_b Self-supporting length, upper run bent

In the FL_b range, the chain upper run has a sag of more than 3.15 inch, but this is still less than the maximum sag.

Where the sag is greater than that permitted in the FL_b range, the application is critical and should be avoided. The self-supporting length can be optimized by using a support for the upper run or a more stable cable drag chain.

Closed cable drag chains (with covers) have a higher unit weight than open chains (with crossbars). This higher weight must be taken into account when calculating the self-supporting length. To the weight of the cabling (cable load, in kg/m), you must add 3.1 kg/m, to account for the higher weight of closed-cover chains.

DETERMINING THE CHAIN LENGTH

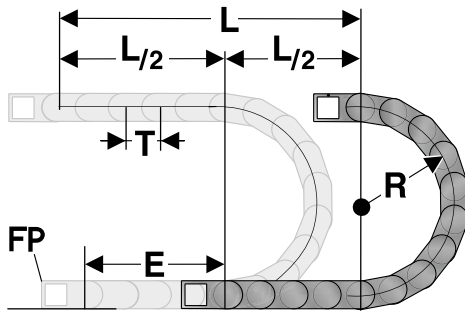

The fixed point of the cable drag chain should be connected in the middle of the travel distance. This arrangement gives the shortest connection between the fixed point (FP) and the moving bracket and thus the most efficient chain length.

Chain length calculation = $L/2 + \pi * R + E$
 $\approx 1 \text{ ft chain} = 3 \text{ qty.} \times 3.94 \text{ inch.}$

- E = Distance between entry point and middle of travel distance
- L = Travel distance
- R = Radius
- P = Grid 3.94 inch

INSTALLATION DIMENSIONS

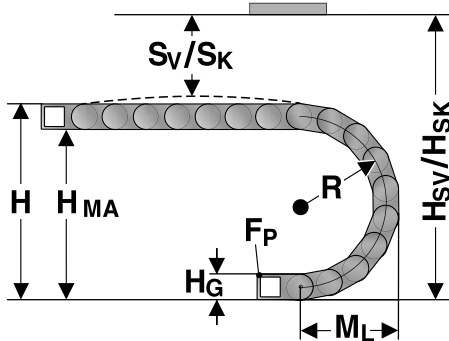

The moving end chain connection is to be screw fixed at height H_{MA} for the respective radius. Concerning the installed dimensions, you must take into account whether the chain links are equipped with or without bias. For chain links without bias, the "Installed height without bias H_{SK} " value has to be taken into account. If the chain links are equipped with a bias, the value "Installed height with bias H_{sv} " has to be taken into account.

Radius R	5.91	7.87	9.84	11.81	13.78	15.75	19.69
Outside height of chain link (H_c)	3.70	3.70	3.70	3.70	3.70	3.70	3.70
Height of bend (H)	16.70	20.62	24.56	28.50	32.44	36.38	44.26
Height of moving end connection (H_{MA})	13.00	16.92	20.86	24.80	28.74	32.68	40.56
Safety margin with bias (S_v)	1.97	1.97	1.97	1.97	1.97	1.97	1.97
Installation height with bias (H_{sv})	18.67	22.59	26.53	30.47	34.41	38.35	46.23
Safety margin without bias (S_k)	0.79	0.79	0.79	0.79	0.79	0.79	0.79
Installation height without bias (H_{sk})	17.49	21.41	25.35	29.29	33.23	37.17	45.05
Arc projection (M_L)	12.29	14.25	16.22	18.19	20.16	22.13	26.07

HEAVYLINE PLASTIC CROSSBAR



The crossbars connect the two side runs of the cable drag chain. The crossbar length is synonymous with the inside width of the cable drag chain.

Type	Order No.	Description	Inside width inch
BS 093-7	072009300000	Crossbar	3.66
BS 106-7	072010600000	Crossbar	4.17
BS 118-7	072011800000	Crossbar	4.65
BS 131-7	072013100000	Crossbar	5.16
BS 143-7	072014300000	Crossbar	5.63

HEAVYLINE PLASTIC CROSSBAR

Type	Order No.	Description	Inside width inch
BS 156-7	072015600000	Crossbar	6.14
BS 168-7	072016800000	Crossbar	6.61
BS 181-7	072018100000	Crossbar	7.13
BS 193-7	072019300000	Crossbar	7.60
BS 206-7	072020600000	Crossbar	8.11
BS 231-7	072023100000	Crossbar	9.09
BS 243-7	072024300000	Crossbar	9.57
BS 256-7	072025600000	Crossbar	10.08
BS 268-7	072026800000	Crossbar	10.55
BS 293-7	072029300000	Crossbar	11.54
BS 318-7	072031800000	Crossbar	12.52
BS 343-7	072034300000	Crossbar	13.50
BS 368-7	072036800000	Crossbar	14.49
BS 418-7	072041800000	Crossbar	16.46
BS 468-7	072046800000	Crossbar	18.43
BS 518-7	072051800000	Crossbar	20.39

MP 62.3 PLASTIC COVER



Cover

The covers connect the two side runs of the cable drag chain. The cover length is synonymous with the inside width of the cable drag chain.

Type	Order No.	Description	Installation site	Inside width inch
A-623118, outside	062311810000	Cover	Outside bend	4.65
I-623118, inside	062311820000	Cover	Inside bend	4.65
A-623143, outside	062314310000	Cover	Outside bend	5.63
I-623143, inside	062314320000	Cover	Inside bend	5.63
A-623193, outside	062319310000	Cover	Outside bend	7.60
I-623193, inside	062319320000	Cover	Inside bend	7.60
A-623243, outside	062324310000	Cover	Outside bend	9.57
I-623243, inside	062324320000	Cover	Inside bend	9.57
A-623293, outside	062329310000	Cover	Outside bend	11.54
I-623293, inside	062329320000	Cover	Inside bend	11.54
A-623343, outside	062334310000	Cover	Outside bend	13.50
I-623343, inside	062334320000	Cover	Inside bend	13.50
A-623418, outside	062341810000	Cover	Outside bend	16.46
I-623418, inside	062341820000	Cover	Inside bend	16.46

KA 62.1 CHAIN BRACKET FLEXIBLE

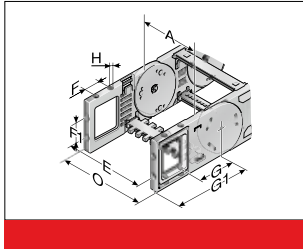

This chain bracket offers universal connection options (top, bottom and front) and is attached to the ends of the chain like a side link. This allows the chain to move right up to the bracket. Each chain requires one male and one female bracket. M8 screws are used to secure the brackets in place. Extrusion-coated metal bushes with either a through-hole (-FB) or a threaded hole (-FG) ensure the permanent, high-strength transmission of even extreme forces onto the cable drag chain.

Type	Order No.	Material	Version	Inside width								Outside width of KA 0
				A inch	E inch	F inch	F1 inch	G inch	G1 inch	H	H0 inch	
KA 62-FB Female end	0620000056	Plastic	with bush	3.66 – 20.39	A+0.67	1.38	1.77	4.21	6.75		0.33	A+1.42
KA 62-FB male end	0620000057	Plastic	with bush	3.66 – 20.39	A+0.67	1.38	1.77	4.21	6.75		0.33	A+1.42
KA 62-FG Female end	0620000058	Plastic	with thread	3.66 – 20.39	A+0.67	1.38	1.77	4.21	6.75	M8		A+1.42
KA 62-FG male end	0620000059	Plastic	with thread	3.66 – 20.39	A+0.67	1.38	1.77	4.21	6.75	M8		A+1.42

KA 62.1 CHAIN BRACKET ANGLE

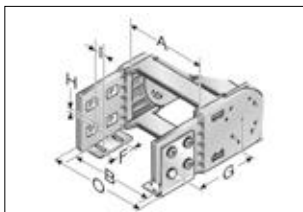

KA 62 (inside top / bottom)

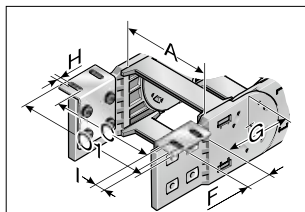

KA 62 (outside top / bottom)

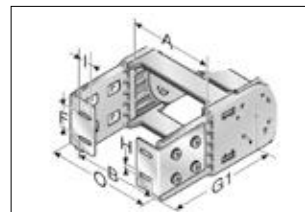

KA 62 (front inside)

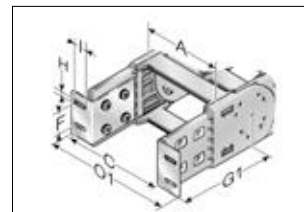

KA 62 (front outside)

This chain bracket offers universal connection options (top, bottom and front) and is attached to the ends of the chain like a side link. This allows the chain to move right up to the bracket. Each chain requires one male and one female bracket. M8

screws are used to secure the brackets in place. Metal inserts (supplied) help to minimize the cold flow properties. This is an enormous advantage, guaranteeing the smooth transfer of high loads to the chain.

Type	Order No.	Material	Inside width A	Inside width							Outside width of KA 0	Outside width of KA 01
				B inch	C inch	F inch	G inch	G1 inch	H0 inch	I inch		
KA 62 Female end	0620000050	Sheet steel	3.66 – 20.39	A-0.47	A+1.73	1.77	4.02	6.75	0.35	0.59	A+1.26	A+3.54
KA 62 Male end	0620000051	Sheet steel	3.66 – 20.39	A-0.47	A+1.73	1.77	4.02	6.75	0.35	0.59	A+1.26	A+3.54

MP 52/62/72 LOCK BUTTON

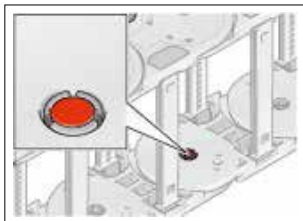

Lock button

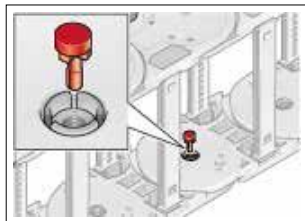

Lock button

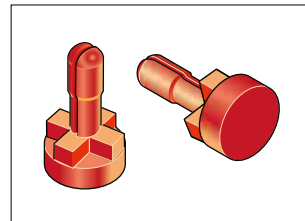

Lock button

To increase the side stability we recommend the use of lock buttons during strong lateral acceleration or when installed “laying

on the side (turned 90°) without support”.

Type	Order No.
MP52/62/72 lock button	0520000080

GS 62.2 SLIDING BLOCK

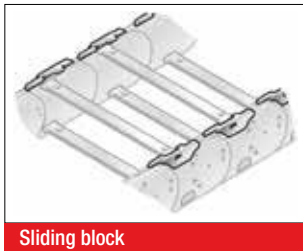

In the case of cable drag chains, sliding blocks are used in a horizontally sliding installation mode (the tight side of the chain slides on the slack side). The sliding blocks are set onto the side links on the interior bend instead of the usual crossbar interlocks; (no tools needed). This forces the chain to slide on the sliding blocks instead on the side links of the chain. Depending on the application, the service life of the cable drag chain may be extended five-fold, by using slide blocks. Information about the minimum bending radius of the cable drag chain at the sliding block insert is listed in the following table.

Type	Order No.	Installation site	Min. radius inch	Sliding block height inch
GS 62.2.1 right	062290400302	For right side link	7.87	0.24
GS 62.2.2 left	062290400300	For left side link	7.87	0.24

TR 62 SEPARATOR

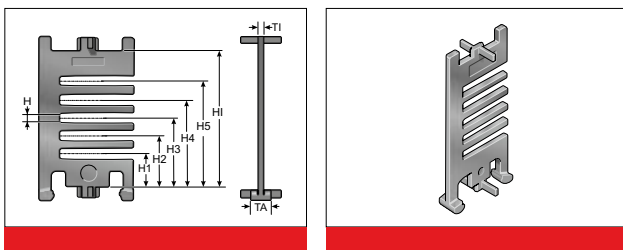

We recommend that separators be used if multiple round cables or conduits with differing diameters are to be installed.

Type	Order No.	Description	Version	TI inch	TA inch	H inch	H1 inch	H2 inch	H3 inch	H4 inch	H5 inch	HI inch
TR 62	062000009200	Separator	lockable	0.14	0.51	0.22	0.58	0.91	1.24	1.56	1.89	2.44

RTT 62 SHELF SUPPORT, DIVISIBLE

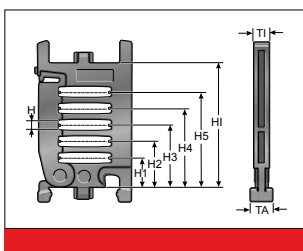

In connection with two separable shelf supports (RTT) with at least one end-to-end shelf (RB) the shelf becomes an easy to fill shelving system. The additional levels prevent cables from criss-crossing and minimize the friction between them.

Type	Order No.	Description	Version	TI inch	TA inch	H inch	H1 inch	H2 inch	H3 inch	H4 inch	H5 inch	HI inch
RTT 62	100090622000	Shelf support, divisible	lockable	0.31	0.31	0.22	0.58	0.91	1.24	1.56	1.89	2.44

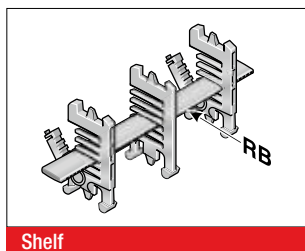
RB-7 SHELF

In connection with at least two separable shelf supports (RTT), the shelf becomes a shelving system. The additional levels prevent cables from criss-crossing and minimize the friction between them.

Type	Order No.	Description	Width inch	Inside width inch
RB 056-7	100000005600	Shelf	2.20	3.66
RB 061-7	1000006107	Shelf	2.40	3.66
RB 066-7	100000006600	Shelf	2.60	3.66
RB 071-7	1000007107	Shelf	2.80	3.66
RB 076-7	1000007607	Shelf	2.99	3.66
RB 081-7	100000008100	Shelf	3.19	3.66
RB 086-7	1000008607	Shelf	3.39	3.66
RB 091-7	1000009107	Shelf	3.58	4.17
RB 096-7	1000009607	Shelf	3.78	4.17
RB 101-7	1000010107	Shelf	3.98	4.17
RB 106-7	100000010600	Shelf	4.17	4.17
RB 111-7	1000011107	Shelf	4.37	4.65
RB 116-7	100000011600	Shelf	4.57	4.65
RB 121-7	1000012107	Shelf	4.76	5.16
RB 126-7	1000012607	Shelf	4.96	5.16
RB 131-7	1000013107	Shelf	5.16	5.63
RB 136-7	1000013607	Shelf	5.35	5.63
RB 141-7	1000014107	Shelf	5.55	5.63
RB 146-7	1000014607	Shelf	5.75	6.14
RB 151-7	1000015107	Shelf	5.94	6.14
RB 156-7	1000015607	Shelf	6.14	6.14
RB 161-7	1000016107	Shelf	6.34	6.61
RB 166-7	100000016600	Shelf	6.54	6.61
RB 171-7	1000017107	Shelf	6.73	7.13
RB 176-7	1000017607	Shelf	6.93	7.13
RB 181-7	1000018107	Shelf	7.13	7.60
RB 186-7	1000018607	Shelf	7.32	7.60
RB 191-7	1000019107	Shelf	7.52	7.60
RB 196-7	1000019607	Shelf	7.72	8.11
RB 201-7	1000020107	Shelf	7.91	8.11
RB 206-7	1000020607	Shelf	8.11	8.11
RB 211-7	1000021107	Shelf	8.31	8.58
RB 216-7	100000021600	Shelf	8.50	8.58

RSV 62 CROSSBAR CONNECTOR



For crossbars wider than 9.69 inch (246 mm), we recommend the use of crossbar connectors. These prevent deformation to the crossbar under large amounts of additional weight of the chain assembly.

Type	Order No.	Description	Tl inch
RSV 62	062000009600	Crossbar connector	0.31
RSV 62 Alu	062000009800	Crossbar connector for aluminum crossbars	0.31

BS-5 BRACKET BAR



Large-diameter conduits are routed securely by using bracket bars (BS). This bar is installed on the crossbars or the covers of the cable drag chain. The bracket bar can be installed on both the inside and outside bend. The bracket bar support (BSH) is used to attach the bars to PowerLine series crossbars. Two bracket bar supports are required for each bar.

Type	Order No.	Description	Conduit diameter max. inch	Installation height inch	Inner chain width min. inch
BS 120-5	052412000000	Bracket bar	4.53	5.51	6.46
BS 153-5	052415300000	Bracket bar	5.83	6.69	8.19
BS 187-5	052418700000	Bracket bar	7.17	8.07	9.17
Assembly set	052400000001	Assembly set			

D6 CHAIN BRACKET COVER



Self-locking covers close the side mounting window on the flexible chain bracket (KA-FB/FG).

Type	Order No.
Cover D6 KA 62.1-FB/FG	0623888002

MP 62.3 CHAIN BRACKET CANOPY



Constructed from aluminum, the canopies for the flexible chain bracket (KA-FB/FG) ensure a continuously closed system for chains with covers.

Canopy for chain bracket, fixed point outside bend: Type and Order No. configurator



Type:	KA 62.1 FB/FG AB	Inside width	2-2
Order No.:	0621	Inside width	060

Canopy for chain bracket, fixed point inside bend: Type and Order No. configurator

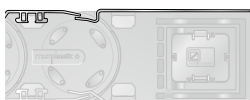

Type:	KA 62.1 FB/FG IB	Inside width	2-2
Order No.:	0621	Inside width	058

Canopy for chain bracket, moving end outside bend: Type and Order No. configurator



Type:	KA 62.1 FB/FG AB	Inside width	1-2
Order No.:	0621	Inside width	059

Canopy for chain bracket, moving end inside bend: Type and Order No. configurator



Type:	KA 62.1 FB/FG IB	Inside width	1-2
Order No.:	0621	Inside width	057

Ordering example:

0621096058 KA 62.1 FB/FG IB 118 2-2

Chain bracket canopy at fixing point in inside bend, for inside width of 4.65 inch (118 mm).

RS-ZL-7 CROSSBAR STRAIN RELIEF PLATE

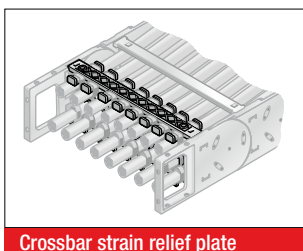

Fixed integrated crossbar strain relief plates in the chain brackets. Accommodated to all widths of the frame ridges, up to 10.08 inch in size. May be assembled on the inside and outside bends at both chain endings.

Type	Order No.	Description	Inside width inch
RS-ZL 093-7	072009300010	Crossbar strain relief plate	3.66
RS-ZL 106-7	072010600010	Crossbar strain relief plate	4.17
RS-ZL 118-7	072011800010	Crossbar strain relief plate	4.65
RS-ZL 131-7	072013100010	Crossbar strain relief plate	5.16
RS-ZL 143-7	072014300010	Crossbar strain relief plate	5.63
RS-ZL 156-7	072015600010	Crossbar strain relief plate	6.14
RS-ZL 168-7	072016800010	Crossbar strain relief plate	6.61
RS-ZL 181-7	072018100010	Crossbar strain relief plate	7.13
RS-ZL 193-7	072019300010	Crossbar strain relief plate	7.60

RS-ZL-7 CROSSBAR STRAIN RELIEF PLATE

Type	Order No.	Description	Inside width inch
RS-ZL 206-7	072020600010	Crossbar strain relief plate	8.11
RS-ZL 218-7	072021800010	Crossbar strain relief plate	8.58
RS-ZL 231-7	072023100010	Crossbar strain relief plate	9.09
RS-ZL 243-7	072024300010	Crossbar strain relief plate	9.57
RS-ZL 256-7	072025600010	Crossbar strain relief plate	10.08

STRAIN RELIEF WITH STEEL FIX

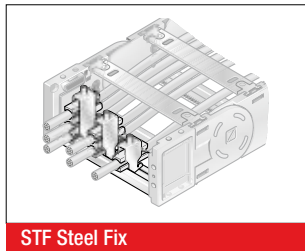
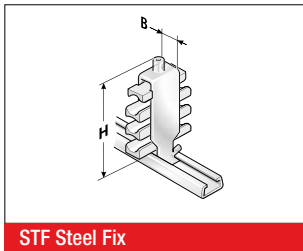

C-rails (galvanized) for permanent integration, for accommodating the Steel Fix bow clamps in the chain brackets. The bow clamps can take up to 3 cables and are suitable for C-rails with a groove width of 0.43 in (11 mm). Due to the design of the trough elements, a cable preserving cable guidance is ensured. May be assembled on the inside and outside bends at both chain endings. The overall height stated is a guide only. The actual height is, amongst other things, dependent on the diameter and the quality of the cable. A safety distance of 0.39 in (10 mm) at the fixed point above the strain relief must be kept during gliding applications.

Type	Order No.	Description	Seats qty.	Cable Ø inch	Width (B) inch	Total height (H) inch
Single clamp (for one cable)						
STF 12-1 Steel Fix	81661801	Hooped clamp	1	0.24 – 0.47	0.63	2.17
STF 14-1 Steel Fix	81661802	Hooped clamp	1	0.47 – 0.55	0.71	2.05
STF 16-1 Steel Fix	81661803	Hooped clamp	1	0.55 – 0.63	0.79	2.13
STF 18-1 Steel Fix	81661804	Hooped clamp	1	0.63 – 0.71	0.87	2.20
STF 20-1 Steel Fix	81661805	Hooped clamp	1	0.71 – 0.79	0.94	2.32
STF 22-1 Steel Fix	81661806	Hooped clamp	1	0.79 – 0.87	1.02	2.40
STF 26-1 Steel Fix	81661807	Hooped clamp	1	0.87 – 1.02	1.18	2.76
STF 30-1 Steel Fix	81661808	Hooped clamp	1	1.02 – 1.18	1.34	2.91
STF 34-1 Steel Fix	81661809	Hooped clamp	1	1.18 – 1.34	1.50	3.07
STF 38-1 Steel Fix	81661810	Hooped clamp	1	1.34 – 1.50	1.65	3.23
STF 42-1 Steel Fix	81661811	Hooped clamp	1	1.50 – 1.65	1.81	3.58
Double clamp (for two cables)						
STF 12-2 Steel Fix	81661821	Hooped clamp	2	0.24 – 0.47	0.63	2.87
STF 14-2 Steel Fix	81661822	Hooped clamp	2	0.47 – 0.55	0.71	2.91
STF 16-2 Steel Fix	81661823	Hooped clamp	2	0.55 – 0.63	0.79	3.23
STF 18-2 Steel Fix	81661824	Hooped clamp	2	0.63 – 0.71	0.87	3.39
STF 20-2 Steel Fix	81661825	Hooped clamp	2	0.71 – 0.79	0.94	3.58
STF 22-2 Steel Fix	81661826	Hooped clamp	2	0.79 – 0.87	1.02	3.74
STF 26-2 Steel Fix	81661827	Hooped clamp	2	0.87 – 1.02	1.18	4.25
STF 30-2 Steel Fix	81661828	Hooped clamp	2	1.02 – 1.18	1.34	4.76
STF 34-2 Steel Fix	81661829	Hooped clamp	2	1.18 – 1.34	1.50	5.08
Triple clamp (for three cables)						
STF 12-3 Steel Fix	81661841	Hooped clamp	3	0.24 – 0.47	0.63	3.86
STF 14-3 Steel Fix	81661842	Hooped clamp	3	0.47 – 0.55	0.71	3.86
STF 16-3 Steel Fix	81661843	Hooped clamp	3	0.55 – 0.63	0.79	4.13
STF 18-3 Steel Fix	81661844	Hooped clamp	3	0.63 – 0.71	0.87	4.37
STF 20-3 Steel Fix	81661845	Hooped clamp	3	0.71 – 0.79	0.94	4.65
STF 22-3 Steel Fix	81661846	Hooped clamp	3	0.79 – 0.87	1.02	5.12

LOWERED FIXING POINT MP 62

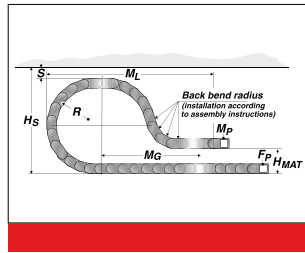
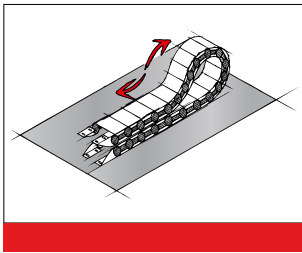

It is sometimes necessary to lower the height of the moving attachment point. In such cases, modifications to the chain layout should be noted (e.g. extension of chain). Please contact our application engineers.

Radius R inch	Height of moving end connection (H _{MA}) inch	Safety margin (S) inch	Installation height incl. safety (H _S) inch	Projection (M _I) inch	Additional links qty.	of which additional back chain links qty.
7.87	9.06	2.36	22.20	33.46	11	2
9.84	10.63	2.36	26.14	38.98	12	2
11.81	12.60	2.36	30.08	41.73	12	3
15.75	14.96	3.54	27.32	41.73	14	3
19.69	17.32	2.36	45.83	59.84	17	3

MP 62.2 REARWARD RADII

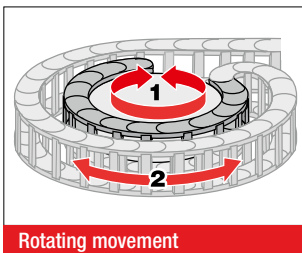

Rotating movement

Side links with forward radius (R) and rearward radius (Rü) allow movements in both directions. This is intended for rotating movements and lowered chain brackets. Note: This type of chain has different chain links for the left or right side! Rotation movements are only possible with open variants.

Type	Order No.	Radius inch	Back radius inch
SR 62.2 (RÜ300/R300) left	062200030060	11.81	11.81
SR 62.2 (RÜ300/R300) right	062200030062	11.81	11.81

GUIDE CHANNEL VAW (ALUMINUM / STAINLESS STEEL)



VAW steel galvanized / stainless steel



VAW aluminum

A range of variable guide channel systems, constructed from aluminum or stainless steel sections, is available for this cable drag chain. The variable guide channel ensures that the cable drag chain is supported and guided securely.

ASSEMBLY INSTRUCTION FLEXIBLE CHAIN BRACKET FB/FG

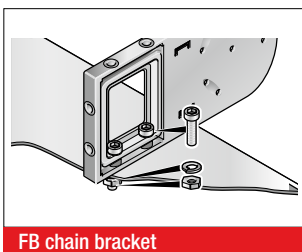

FB chain bracket

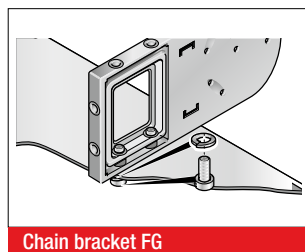

Chain bracket FG

Brass bushes guarantee long-lasting fastening without cold flow in the plastic.

Version KA-FB:

Integrated through-hole fastened down using nut and bolt.

Version KA-FG:

Built-in threads allow for quick and easy on-site mounting, since a screw, including a retaining washer where necessary, is sufficient.

ASSEMBLY

DISASSEMBLY

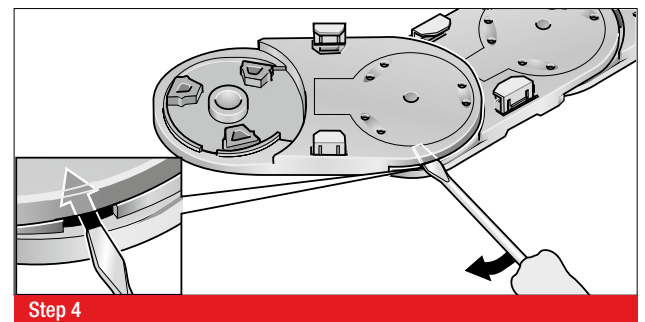
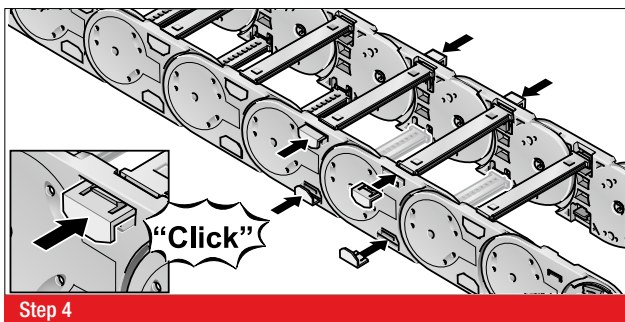
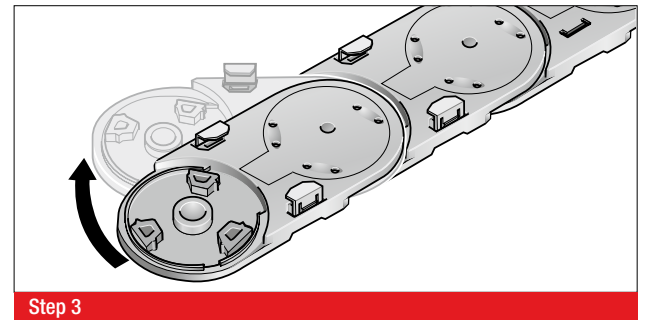
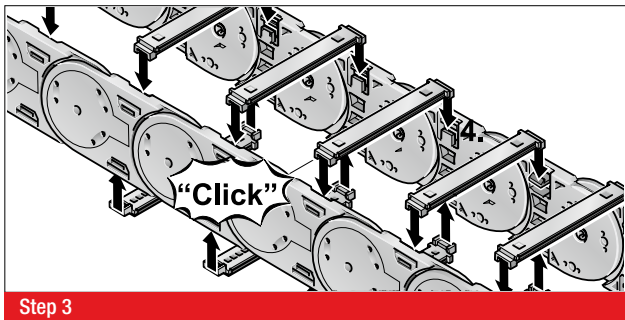
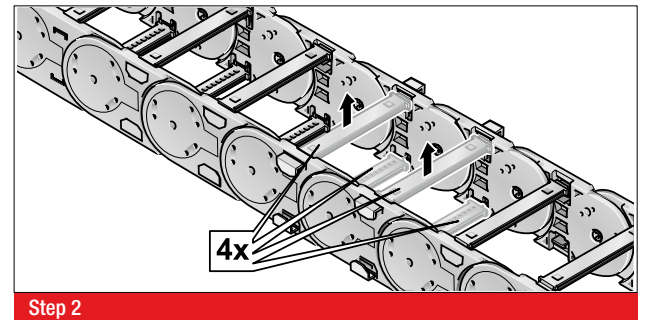
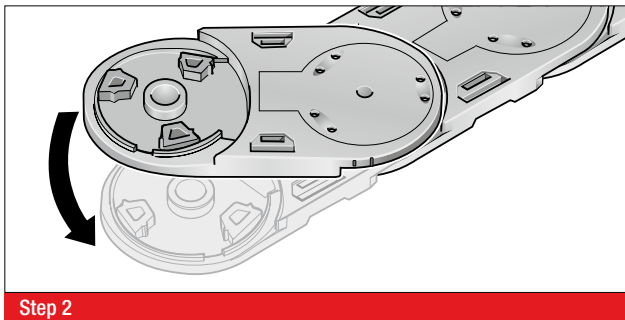
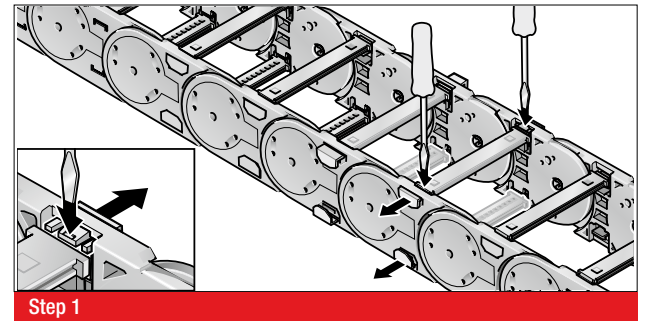
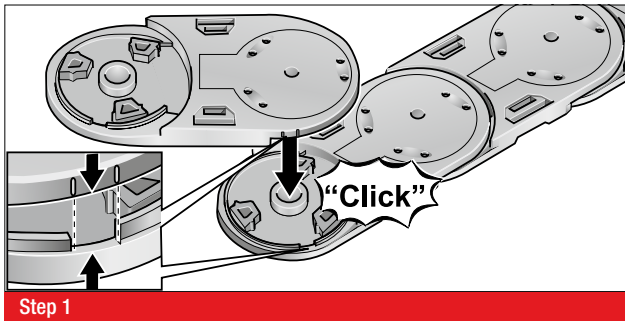

MP 82.2
OPEN



MP 82.3
CLOSED



- SLIDING BLOCKS FOR LONGER SERVICE LIFE
- BROAD INTERIOR LAYOUT
- CHAIN BRACKET FLEXIBLE
- PLASTIC OR ALUMINUM VERSION
- SIDE LINK LOCK

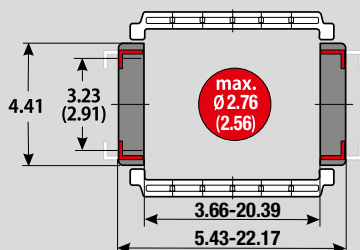

TECHNICAL DATA

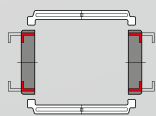

Loading side
Inside and outside bend

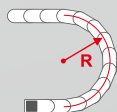

Available radii
5.91 – 25.59 inch

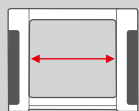

Available interior widths
With plastic crossbar
3.66 – 20.39 inch
With aluminum crossbar / cover
2.83 – 23.62 inch / 1.57 – 23.62 inch

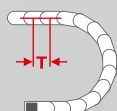

Grid
T = 4.65 inch

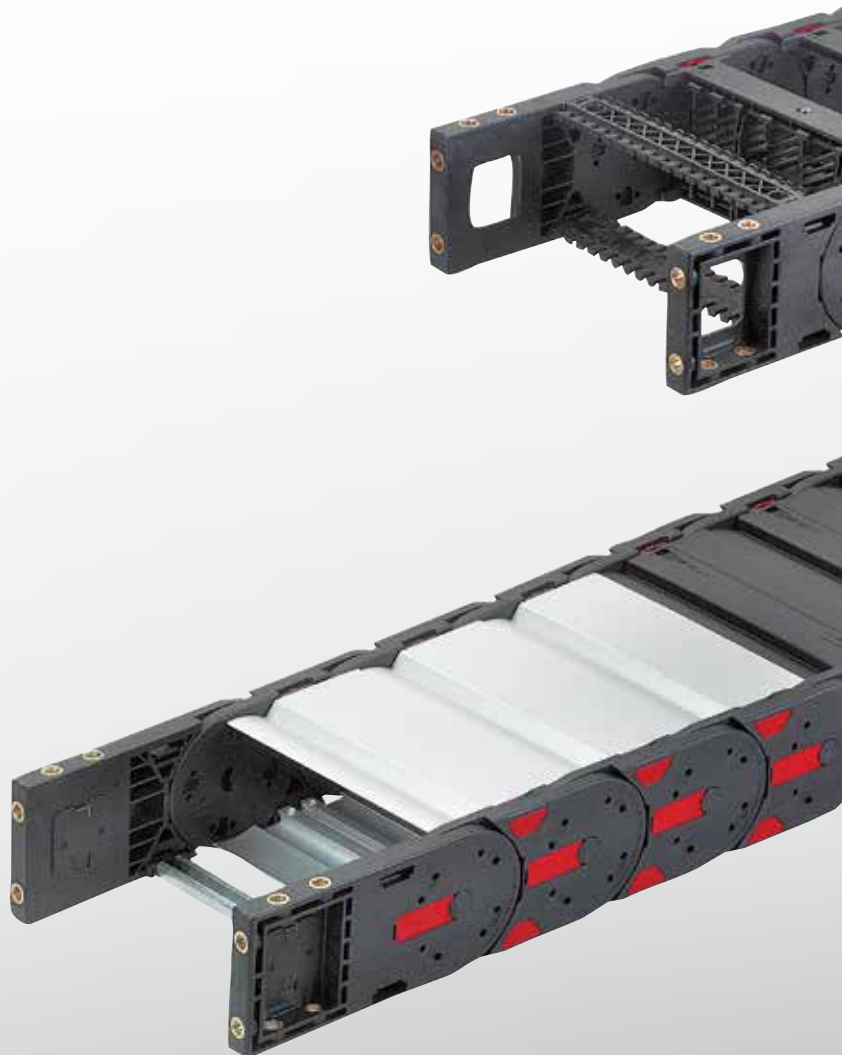



TECHNICAL SPECIFICATIONS

Travel distance gliding L_g max.	492.13 ft.
Travel distance self-supporting L_s max.	see diagram on page 307
Travel distance vertical, hanging L_{vh} max.	262.47 ft.
Travel distance vertical, upright L_{vs} max.	19.69 ft.
Rotated 90°, unsupported L_{90f} max.	9.84 ft.
Speed, gliding V_g max.	16.40 ft/s
Speed, self-supporting V_f max.	65.62 ft/s
Acceleration, gliding a_g max.	82.02 ft/s ²
Acceleration, self-supporting a_s max.	131.23 ft/s ²

Contact our engineering department to meet any higher requirements: efk@murrplastik.de

MATERIAL PROPERTIES

Standard material	Polyamide (PA) black
Service temperature	-22.00 – 248.00 °F
Gliding friction factor	0.30
Static friction factor	0.45
Fire classification	UL 94 HB

Other material properties on request

ACCESSORIES



Sliding block

SHELVING SYSTEM



Separator TR



Gliding plate

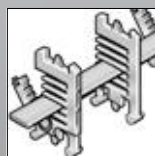

RS shelving system



Bracket bar

GUIDE CHANNELS



VAW steel galvanized / stainless steel



RS-ZL crossbar strain relief

CHAIN BRACKET

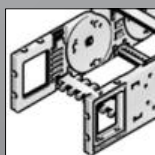

Chain bracket flexible



Crossbar connector RSV



Cover

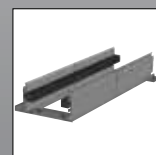

VAW aluminum



STF Steel Fix

ORDERING KEY

Dimensions in mm [US inch]

Type code	Variation	Inside width	Outside width	Inside width	Outside width	Radius	Rail variant	Material	Chain length
0822 30	MP 82.2 open Crossbar on outside bend Crossbar on inside bend Opens on inside and outside of bend	093 [3.66]	138 [5.43]	468 [18.43]	513 [20.20]	150 ¹⁾ [5.91]	0 Plastic, full-ridged with bias	0 Polyamide (PA): standard (PA/black)	
		106 [4.17]	151 [5.94]	518 [20.39]	563 [22.17]				
0823 44 ²⁾	MP 82.3 closed Cover on outside of bend Cover on inside of bend Opens on inside and outside of bend	118 [4.65]	163 [6.42]			200 [7.87]	1 Plastic, full-ridged without bias	5 Polypropylene (PP/blue)	
		131 [5.16]	176 [6.93]						
		143 [5.63]	188 [7.40]			250 [9.84]	2 Plastic, half-ridged with bias	7 ESD (PA/light gray)	
		156 [6.14]	201 [7.91]						
		168 [6.61]	213 [8.39]			300 [11.81]	3 Plastic, half-ridged without bias	9 Special version (on request)	
		181 [7.13]	226 [8.90]						
		193 [7.60]	238 [9.37]			350 [13.78]	4 Aluminum full-ridged with bias		
		206 [8.11]	251 [9.88]						
		218 [8.58]	263 [10.35]			400 [15.75]	5 Aluminum full-ridged without bias		
		231 [9.09]	276 [10.87]						
		243 ³⁾ [9.57]	288 [11.34]			500 [19.69]	6 Aluminum half-ridged with bias		
		256 [10.08]	301 [11.85]						
		268 [10.55]	313 [12.32]			650 [25.59]	7 Aluminum half-ridged without bias		
		293 [11.54]	338 [13.31]						
		318 [12.52]	363 [14.29]				9 Special version (on request)		
		343 [13.50]	388 [15.28]						
		368 [14.49]	413 [16.26]						
		418 [16.46]	463 [18.23]						

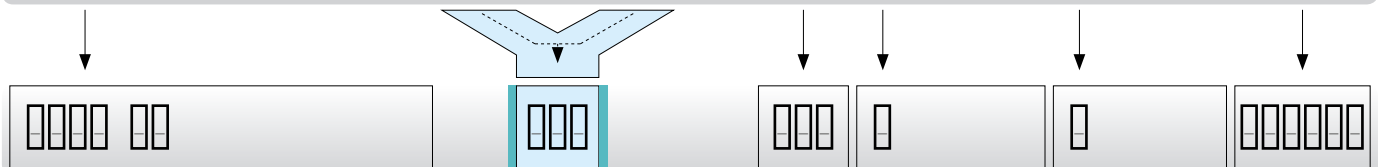

ORDERING EXAMPLE: 0822 118 150 0 0 000060

Crossbar on outside bend, crossbar on inside bend, can be opened from inside and outside bend
 Inside width 4.65 in.; radius 5.91 in.
 Plastic crossbar, full-ridged with bias, material black-colored polyamide
 Chain length 60 in. (13 links)

- ¹⁾ for Variant 30 only
- ²⁾ reduced inner height, reduced max. cable diameter, see chain window drawing on previous page
- ³⁾ also available with plastic cover

NOTE ON CONFIGURATION

Aluminum crossbars:

Aluminum crossbars in 0.04 in (1 mm) width sizes for inner widths from 2.83 inch – 23.62 inch are available for delivery.

Aluminum covers:

Aluminum covers in 0.04 in (1 mm) width sizes for inner widths from 1.57 inch – 23.62 inch are available for delivery.

Crossbar connector and crossbar strain relief plate:

Once inside widths exceed 9.69 inches (243 mm), we recommend the deployment of crossbar connectors (RSV). Crossbar connectors cannot be used in conjunction with covers made from plastic or aluminum.

If crossbar strain relief plates (RS-ZL) are to be deployed in the chain brackets, take standard inside widths into account.

For detailed information, please consult the corresponding product documentation.

SELF-SUPPORTING LENGTH

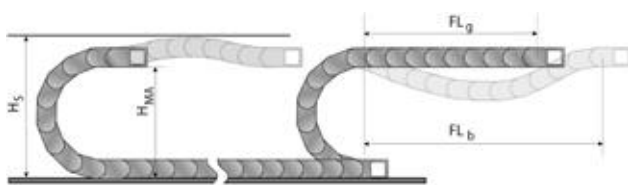

The self-supporting length is the distance between the chain bracket on the moving end and the start of the chain arch.

The installation variant FL_g offers the lowest load and wear for the cable drag chain.

The maximum travel parameters (speed and acceleration) can be applied for this variant.

H_s = Installation height plus safety

H_{MA} = Height of moving end connection

FL_g = Self-supporting length, upper run straight

FL_b = Self-supporting length, upper run bent

LOAD DIAGRAM FOR SELF-SUPPORTING APPLICATIONS

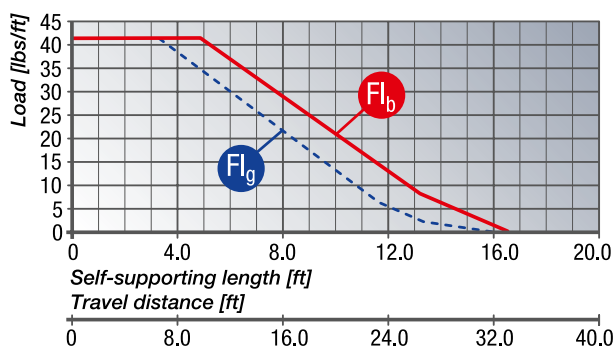

FL_g Self-supporting length, upper run straight

In the FL_g range, the chain upper run still has a bias, is straight or has a maximum sag of 3.15 inch.

FL_b Self-supporting length, upper run bent

In the FL_b range, the chain upper run has a sag of more than 3.15 inch, but this is still less than the maximum sag.

Where the sag is greater than that permitted in the FL_b range, the application is critical and should be avoided. The self-supporting length can be optimized by using a support for the upper run or a more stable cable drag chain.

Closed cable drag chains (with covers) have a higher unit weight than open chains (with crossbars). This higher weight must be taken into account when calculating the self-supporting length. To the weight of the cabling (cable load, in kg/m), you must add 3.1 kg/m, to account for the higher weight of closed-cover chains.

DETERMINING THE CHAIN LENGTH

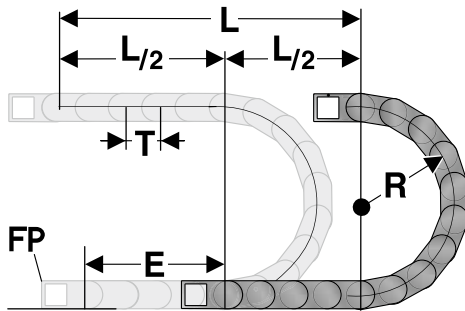

The fixed point of the cable drag chain should be connected in the middle of the travel distance. This arrangement gives the shortest connection between the fixed point (FP) and the moving bracket and thus the most efficient chain length.

Chain length calculation = $L/2 + \pi * R + E$
 $\approx 1 \text{ ft chain} = 3 \text{ qty.} \times 4.65 \text{ inch.}$

- E = Distance between entry point and middle of travel distance
- L = Travel distance
- R = Radius
- P = Grid 4.65 inch

INSTALLATION DIMENSIONS

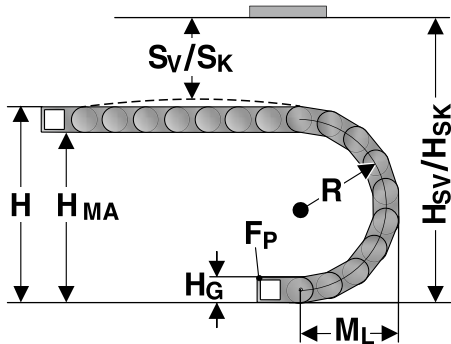

The moving end chain connection is to be screw fixed at height H_{MA} for the respective radius. Concerning the installed dimensions, you must take into account whether the chain links are equipped with or without bias. For chain links without bias, the "Installed height without bias H_{SK} " value has to be taken into account. If the chain links are equipped with a bias, the value "Installed height with bias H_{sv} " has to be taken into account.

Radius R	5.91	7.87	9.84	11.81	13.78	15.75	19.69	25.59
Outside height of chain link (H_o)	4.41	4.41	4.41	4.41	4.41	4.41	4.41	4.41
Height of bend (H)	16.63	20.55	24.49	28.43	32.37	36.31	44.19	55.99
Height of moving end connection (H_{MA})	12.22	16.14	20.08	24.02	27.96	31.90	39.78	51.58
Safety margin (S)	1.97	1.97	1.97	1.97	1.97	1.97	1.97	1.97
Installation height (H_s)	17.81	21.73	25.67	29.61	33.55	37.49	45.37	57.17
Safety margin without bias (S_R)	1.18	1.18	1.18	1.18	1.18	1.18	1.18	1.18
Installation height without bias (H_{SK})	17.81	21.73	25.67	29.61	33.55	37.49	45.37	57.17
Arc projection (M_L)	12.97	14.93	16.90	18.87	20.84	22.81	26.74	32.64

HEAVYLINE PLASTIC CROSSBAR



The crossbars connect the two side runs of the cable drag chain. The crossbar length is synonymous with the inside width of the cable drag chain.

Type	Order No.	Description	Inside width inch
BS 093-7	072009300000	Crossbar	3.66
BS 106-7	072010600000	Crossbar	4.17
BS 118-7	072011800000	Crossbar	4.65
BS 131-7	072013100000	Crossbar	5.16
BS 143-7	072014300000	Crossbar	5.63
BS 156-7	072015600000	Crossbar	6.14
BS 168-7	072016800000	Crossbar	6.61
BS 181-7	072018100000	Crossbar	7.13
BS 193-7	072019300000	Crossbar	7.60
BS 206-7	072020600000	Crossbar	8.11
BS 231-7	072023100000	Crossbar	9.09
BS 243-7	072024300000	Crossbar	9.57
BS 256-7	072025600000	Crossbar	10.08
BS 268-7	072026800000	Crossbar	10.55
BS 293-7	072029300000	Crossbar	11.54
BS 318-7	072031800000	Crossbar	12.52
BS 343-7	072034300000	Crossbar	13.50
BS 368-7	072036800000	Crossbar	14.49
BS 418-7	072041800000	Crossbar	16.46
BS 468-7	072046800000	Crossbar	18.43
BS 518-7	072051800000	Crossbar	20.39

MP 82.3 PLASTIC COVER



The covers connect the two side runs of the cable drag chain. The cover length is synonymous with the inside width of the cable drag chain.

Type	Order No.	Description	Installation site	Inside width inch
A-823243, outside	082324310000	Cover	Outside bend	9.57
I-823243, inside	082324320000	Cover	Inside bend	9.57

KA 82.2 CHAIN BRACKET FLEXIBLE

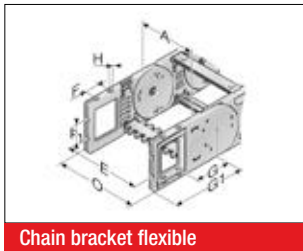

Chain bracket flexible

This chain bracket offers universal connection options (top, bottom and front) and is attached to the ends of the chain like a side link. This allows the chain to move right up to the bracket. Each chain requires one male and one female bracket. M8 screws are used to secure the brackets in place. Pressed-in metal bushes with a through-hole ensure the permanent, high-strength transmission of even extreme forces onto the cable drag chain.

Type	Order No.	Material	Version	Inside width								Outside width of KA O inch
				A inch	E inch	F inch	F1 inch	G inch	G1 inch	H	H0 inch	
KA 82-FB Female end	0820000056	Plastic	with bush	3.66 – 20.39	A+0.91	1.38	2.60	4.61	7.17		0.43	A+1.77
KA 82-FB male end	0820000057	Plastic	with bush	3.66 – 20.39	A+0.91	1.38	2.60	4.61	7.17		0.43	A+1.77
KA 82-FG Female end	0820000058	Plastic	with thread	3.66 – 20.39	A+0.91	1.38	2.60	4.61	7.17	M10		A+1.77
KA 82-FG male end	0820000059	Plastic	with thread	3.66 – 20.39	A+0.91	1.38	2.60	4.61	7.17	M10		A+1.77

GS 82.2 SLIDING BLOCK

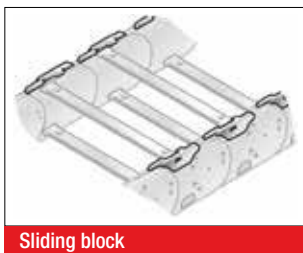

Sliding block

In the case of cable drag chains, sliding blocks are used in a horizontally sliding installation mode (the tight side of the chain slides on the slack side). The sliding blocks are set onto the side links on the interior bend instead of the usual crossbar interlocks; (no tools needed). This forces the chain to slide on the sliding blocks instead on the side links of the chain.

Depending on the application, the service life of the cable drag chain may be extended five-fold, by using slide blocks.

Information about the minimum bending radius of the cable drag chain at the sliding block insert is listed in the following table.

Type	Order No.	Installation site	Min. radius inch	Sliding block height inch
GS 82.2.1 right	082290400302	For right side link	7.87	0.24
GS 82.2.2 left	082290400300	For left side link	7.87	0.24

GLP 8 (82.2) GLIDING PLATE



Gliding plate

The gliding plates are mounted in a horizontal position, with the chain laying on its side, to minimize friction wear to the sides. The gliding plates are placed onto the side links instead of the usual chain link side locks (no tools required). The wear limit is 0.1 in (2.5 mm). We recommend replacing the cable drag chain when this limit has been reached. Depending on the application, the service life of the cable drag chain may be extended two-fold, by using gliding plates. The cable drag chain must be placed on its side before opening.

Type	Order No.	Installation site	Gliding plate height inch
GLP 8	082290400301	GLP8 gliding plate for the MP82.2, MP82.3	0.28

TR 82 SEPARATOR

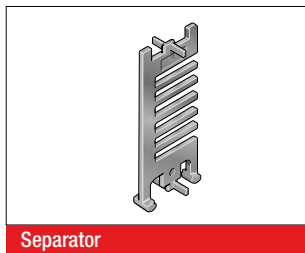
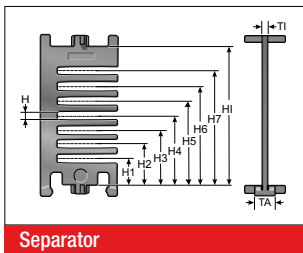

We recommend that separators be used if multiple round cables or conduits with differing diameters are to be installed.

Type	Order No.	Description	Version	TI inch	TA inch	H inch	H1 inch	H2 inch	H3 inch	H4 inch	H5 inch	H6 inch	H7 inch	HI inch
TR 82-S	082000009300	Separator	lockable	0.16	0.58	0.22	0.91	1.56	2.22					3.23
TR 82	082000009200	Separator	lockable	0.14	0.59	0.22	0.59	0.91	1.24	1.57	1.89	2.22	2.55	3.23

RTT 82 SHELF SUPPORT, DIVISIBLE

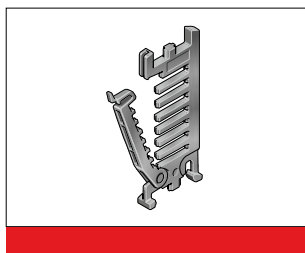
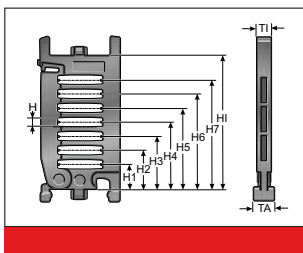

In connection with two separable shelf supports (RTT) with at least one end-to-end shelf (RB) the shelf becomes an easy to fill shelving system. The additional levels prevent cables from criss-crossing and minimize the friction between them.

Type	Order No.	Description	Version	TI inch	TA inch	H inch	H1 inch	H2 inch	H3 inch	H4 inch	H5 inch	H6 inch	H7 inch	HI inch
RTT 82	100090822000	Shelf support, divisible	lockable	0.31	0.31	0.22	0.59	0.91	1.24	1.57	1.89	2.22	2.55	3.23

MP 82.2 CROSSBAR CONNECTOR



For crossbars wider than 9.69 inch (246 mm), we recommend the use of crossbar connectors. These prevent deformation to the crossbar under large amounts of additional weight of the chain assembly.

Type	Order No.	Description	TI inch
RSV 82	082000009600	Crossbar connector	0.31
RSV 82 Alu	082000009800	Crossbar connector for aluminum crossbars	0.31

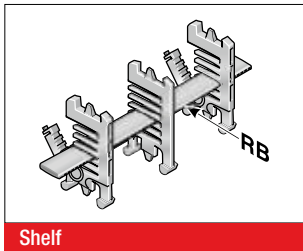
RB-7 SHELF

In connection with at least two separable shelf supports (RTT), the shelf becomes a shelving system. The additional levels prevent cables from criss-crossing and minimize the friction between them.

Type	Order No.	Description	Width inch	Inside width inch
RB 056-7	100000005600	Shelf	2.20	3.66
RB 061-7	1000006107	Shelf	2.40	3.66
RB 066-7	100000006600	Shelf	2.60	3.66
RB 071-7	1000007107	Shelf	2.80	3.66
RB 076-7	1000007607	Shelf	2.99	3.66
RB 081-7	100000008100	Shelf	3.19	3.66
RB 086-7	1000008607	Shelf	3.39	3.66
RB 091-7	1000009107	Shelf	3.58	4.17
RB 096-7	1000009607	Shelf	3.78	4.17
RB 101-7	1000010107	Shelf	3.98	4.17
RB 106-7	100000010600	Shelf	4.17	4.17
RB 111-7	1000011107	Shelf	4.37	4.65
RB 116-7	100000011600	Shelf	4.57	4.65
RB 121-7	1000012107	Shelf	4.76	5.16
RB 126-7	1000012607	Shelf	4.96	5.16
RB 131-7	1000013107	Shelf	5.16	5.63
RB 136-7	1000013607	Shelf	5.35	5.63
RB 141-7	1000014107	Shelf	5.55	5.63
RB 146-7	1000014607	Shelf	5.75	6.14
RB 151-7	1000015107	Shelf	5.94	6.14
RB 156-7	1000015607	Shelf	6.14	6.14
RB 161-7	1000016107	Shelf	6.34	6.61
RB 166-7	100000016600	Shelf	6.54	6.61
RB 171-7	1000017107	Shelf	6.73	7.13
RB 176-7	1000017607	Shelf	6.93	7.13
RB 181-7	1000018107	Shelf	7.13	7.60
RB 186-7	1000018607	Shelf	7.32	7.60
RB 191-7	1000019107	Shelf	7.52	7.60
RB 196-7	1000019607	Shelf	7.72	8.11
RB 201-7	1000020107	Shelf	7.91	8.11
RB 206-7	1000020607	Shelf	8.11	8.11
RB 211-7	1000021107	Shelf	8.31	8.58
RB 216-7	100000021600	Shelf	8.50	8.58

BS-5 BRACKET BAR



Large-diameter conduits are routed securely by using bracket bars (BS). This bar is installed on the crossbars or the covers of the cable drag chain. The bracket bar can be installed on both the inside and outside bend.

The bracket bar support (BSH) is used to attach the bars to PowerLine series crossbars. Two bracket bar supports are required for each bar.

Type	Order No.	Description	Conduit diameter max. inch	Installation height inch	Inner chain width min. inch
BS 120-5	052412000000	Bracket bar	4.53	5.51	6.46
BS 153-5	052415300000	Bracket bar	5.83	6.69	8.19
BS 187-5	052418700000	Bracket bar	7.17	8.07	9.17
Assembly set	052400000001	Assembly set			

D8 CHAIN BRACKET COVER



Self-locking covers close the side mounting window on the flexible chain bracket (KA-FB/FG).

Type	Order No.
Cover D8 KA 82.1 -FB/FG	0823888002

MP 82.3 CHAIN BRACKET CANOPY



Constructed from aluminum, the canopies for the flexible chain bracket (KA-FB/FG) ensure a continuously closed system for chains with covers.

MP 82.3 CHAIN BRACKET CANOPY

Canopy for: chain bracket, fixed point outside bend: Type and Order No. configurator

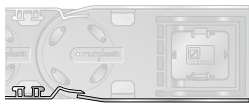

Type:	KA 82.1 FB/FG AB	Inside width	2-2
Order no.:	0821	Inside width	060

Canopy for: chain bracket, fixed point inside bend: Type and Order No. configurator



Type:	KA 82.1 FB/FG IB	Inside width	2-2
Order no.:	0821	Inside width	058

Canopy for: chain bracket, moving end outside bend: Type and Order No. configurator

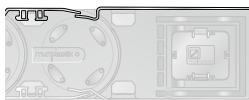

Type:	KA 82.1 FB/FG AB	Inside width	1-2
Order no.:	0821	Inside width	059

Canopy for: chain bracket, moving end inside bend: Type and Order No. configurator



Type:	KA 82.1 FB/FG IB	Inside width	1-2
Order no.:	0821	Inside width	057

Ordering example:

0821118058 KA 82.1 FB/FG IB 118 2-2

Chain bracket canopy at fixing point in inside bend, for inside width of 4.65 inch (118 mm)

RS-ZL-7 CROSSBAR STRAIN RELIEF PLATE

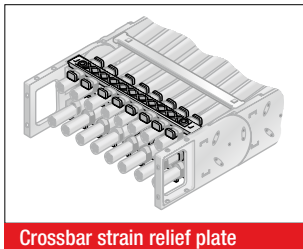

Fixed integrated crossbar strain relief plates in the chain brackets. Accommodated to all widths of the frame ridges, up to 10.08 inch in size. May be assembled on the inside and outside bends at both chain endings.

Type	Order No.	Description	Inside width inch
RS-ZL 093-7	072009300010	Crossbar strain relief plate	3.66
RS-ZL 106-7	072010600010	Crossbar strain relief plate	4.17
RS-ZL 118-7	072011800010	Crossbar strain relief plate	4.65
RS-ZL 131-7	072013100010	Crossbar strain relief plate	5.16
RS-ZL 143-7	072014300010	Crossbar strain relief plate	5.63
RS-ZL 156-7	072015600010	Crossbar strain relief plate	6.14
RS-ZL 168-7	072016800010	Crossbar strain relief plate	6.61
RS-ZL 181-7	072018100010	Crossbar strain relief plate	7.13
RS-ZL 193-7	072019300010	Crossbar strain relief plate	7.60
RS-ZL 206-7	072020600010	Crossbar strain relief plate	8.11
RS-ZL 218-7	072021800010	Crossbar strain relief plate	8.58
RS-ZL 231-7	072023100010	Crossbar strain relief plate	9.09
RS-ZL 243-7	072024300010	Crossbar strain relief plate	9.57
RS-ZL 256-7	072025600010	Crossbar strain relief plate	10.08

STRAIN RELIEF WITH STEEL FIX

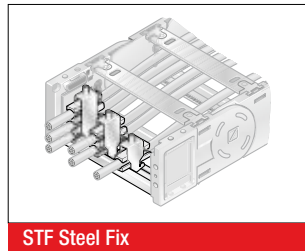
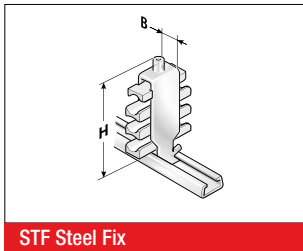

C-rails (galvanized) for permanent integration, for accommodating the Steel Fix bow clamps in the chain brackets. The bow clamps can take up to 3 cables and are suitable for C-rails with a groove width of 0.43 in (11 mm). Due to the design of the trough elements, a cable preserving cable guidance is ensured. May be assembled on the inside and outside bends at both chain endings. The overall height stated is a guide only. The actual height is, amongst other things, dependent on the diameter and the quality of the cable. A safety distance of 0.39 in (10 mm) at the fixed point above the strain relief must be kept during gliding applications.

Type	Order No.	Description	Seats qty.	Cable Ø inch	Width (B) inch	Total height (H) inch
Single clamp (for one cable)						
STF 12-1 Steel Fix	81661801	Hooped clamp	1	0.24 – 0.47	0.63	2.17
STF 14-1 Steel Fix	81661802	Hooped clamp	1	0.47 – 0.55	0.71	2.05
STF 16-1 Steel Fix	81661803	Hooped clamp	1	0.55 – 0.63	0.79	2.13
STF 18-1 Steel Fix	81661804	Hooped clamp	1	0.63 – 0.71	0.87	2.20
STF 20-1 Steel Fix	81661805	Hooped clamp	1	0.71 – 0.79	0.94	2.32
STF 22-1 Steel Fix	81661806	Hooped clamp	1	0.79 – 0.87	1.02	2.40
STF 26-1 Steel Fix	81661807	Hooped clamp	1	0.87 – 1.02	1.18	2.76
STF 30-1 Steel Fix	81661808	Hooped clamp	1	1.02 – 1.18	1.34	2.91
STF 34-1 Steel Fix	81661809	Hooped clamp	1	1.18 – 1.34	1.50	3.07
STF 38-1 Steel Fix	81661810	Hooped clamp	1	1.34 – 1.50	1.65	3.23
STF 42-1 Steel Fix	81661811	Hooped clamp	1	1.50 – 1.65	1.81	3.58
Double clamp (for two cables)						
STF 12-2 Steel Fix	81661821	Hooped clamp	2	0.24 – 0.47	0.63	2.87
STF 14-2 Steel Fix	81661822	Hooped clamp	2	0.47 – 0.55	0.71	2.91
STF 16-2 Steel Fix	81661823	Hooped clamp	2	0.55 – 0.63	0.79	3.23
STF 18-2 Steel Fix	81661824	Hooped clamp	2	0.63 – 0.71	0.87	3.39
STF 20-2 Steel Fix	81661825	Hooped clamp	2	0.71 – 0.79	0.94	3.58
STF 22-2 Steel Fix	81661826	Hooped clamp	2	0.79 – 0.87	1.02	3.74
STF 26-2 Steel Fix	81661827	Hooped clamp	2	0.87 – 1.02	1.18	4.25
STF 30-2 Steel Fix	81661828	Hooped clamp	2	1.02 – 1.18	1.34	4.76
STF 34-2 Steel Fix	81661829	Hooped clamp	2	1.18 – 1.34	1.50	5.08
Triple clamp (for three cables)						
STF 12-3 Steel Fix	81661841	Hooped clamp	3	0.24 – 0.47	0.63	3.86
STF 14-3 Steel Fix	81661842	Hooped clamp	3	0.47 – 0.55	0.71	3.86
STF 16-3 Steel Fix	81661843	Hooped clamp	3	0.55 – 0.63	0.79	4.13
STF 18-3 Steel Fix	81661844	Hooped clamp	3	0.63 – 0.71	0.87	4.37
STF 20-3 Steel Fix	81661845	Hooped clamp	3	0.71 – 0.79	0.94	4.65
STF 22-3 Steel Fix	81661846	Hooped clamp	3	0.79 – 0.87	1.02	5.12

MP 82.2 LOWERED FIXING POINT

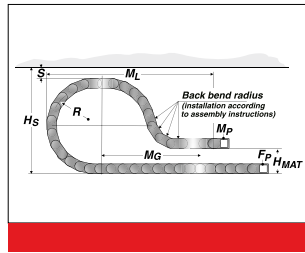
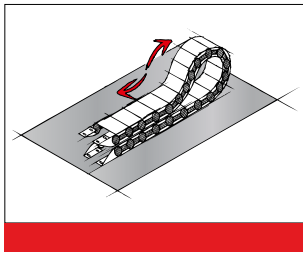

It is sometimes necessary to lower the height of the moving attachment point. In such cases, modifications to the chain layout should be noted (e.g. extension of chain). Please contact our application engineers.

Radius R inch	Height of moving end connection (H _{MA}) inch	Safety margin (S) inch	Installation height incl. safety (h _S) inch	Projection (M _L) inch	Additional links qty.	of which additional back chain links qty.
7.87	9.45	2.36	22.91	35.43	8	2
9.84	10.24	2.36	26.85	41.34	10	2
11.81	11.42	2.36	30.79	44.49	11	2
13.78	12.99	2.36	37.09	49.21	12	2
15.75	16.54	2.36	38.66	52.76	13	2
19.69	15.75	2.36	46.54	63.78	16	4

MP 82.2 REARWARD RADII

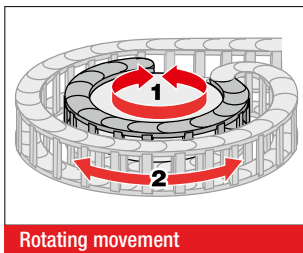

Rotating movement

Side links with forward radius (R) and rearward radius (R_ü) allow movements in both directions. This is intended for rotating movements and lowered chain brackets. Note: This type of chain has different chain links for the left or right side! Rotation movements are only possible with open variants.

Type	Order No.	Radius inch	Back radius inch
SR 82.2 (RÜ300/R300) left	082200030060	11.81	11.81
SR 82.2 (RÜ300/R300) right	082200030062	11.81	11.81

GUIDE CHANNEL VAW (ALUMINUM / STAINLESS STEEL)



VAW steel galvanized / stainless steel



VAW aluminum

A range of variable guide channel systems, constructed from aluminum or stainless steel sections, is available for this cable drag chain. The variable guide channel ensures that the cable drag chain is supported and guided securely.

ASSEMBLY INSTRUCTION FLEXIBLE CHAIN BRACKET FB/FG

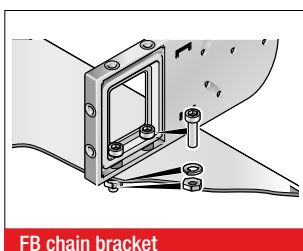

FB chain bracket

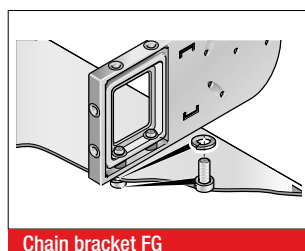

Chain bracket FG

Brass bushes guarantee long-lasting fastening without cold flow in the plastic.

Version KA-FB:

Integrated through-hole fastened down using nut and bolt.

Version KA-FG:

Built-in threads allow for quick and easy on-site mounting, since a screw, including a retaining washer where necessary, is sufficient.

ASSEMBLY

DISASSEMBLY

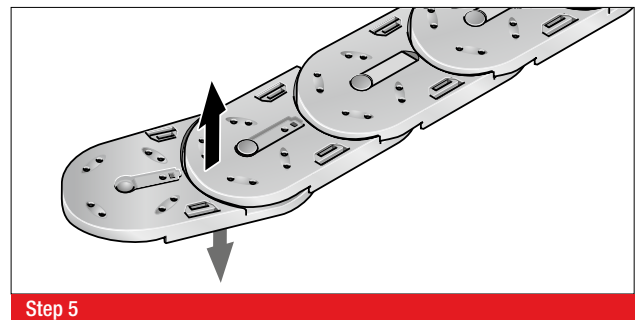
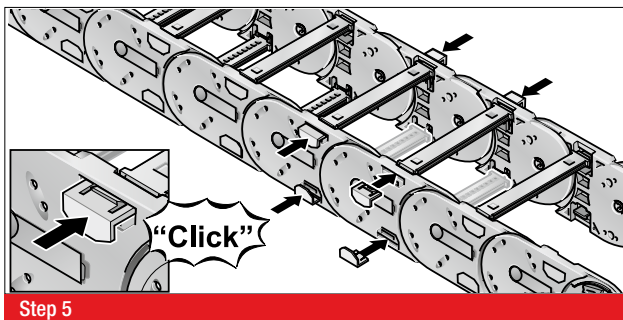
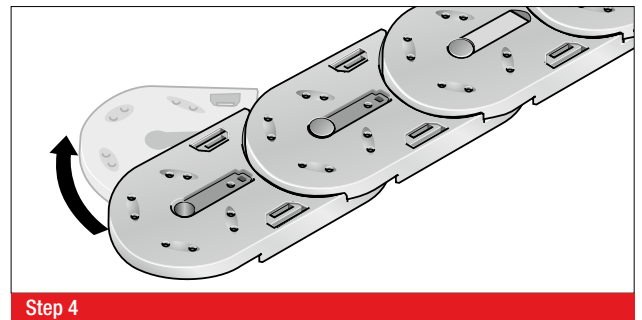
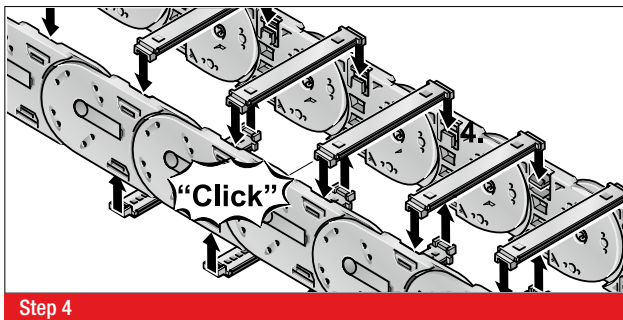
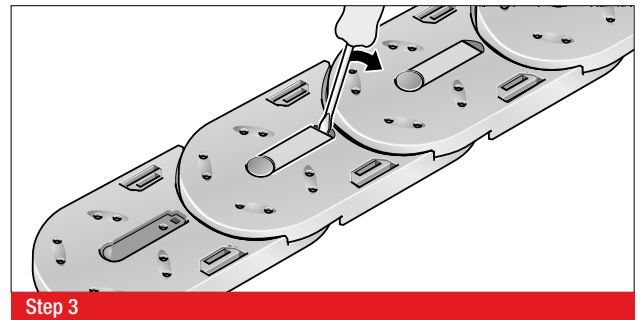
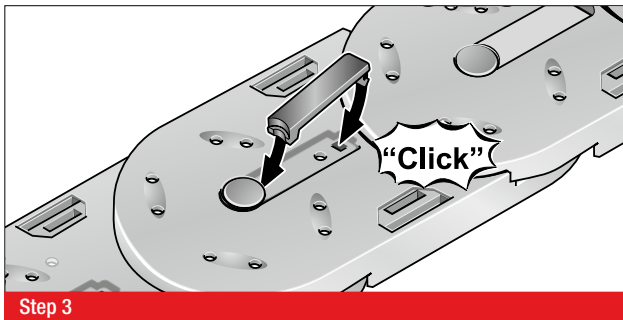
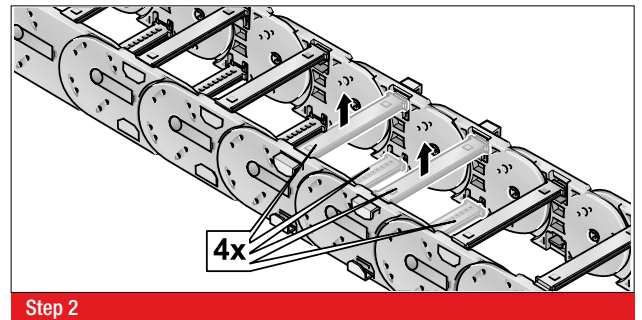
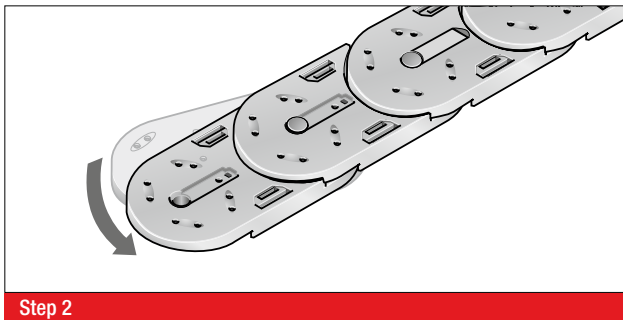
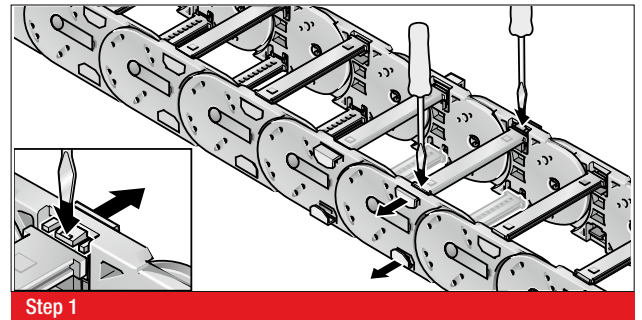
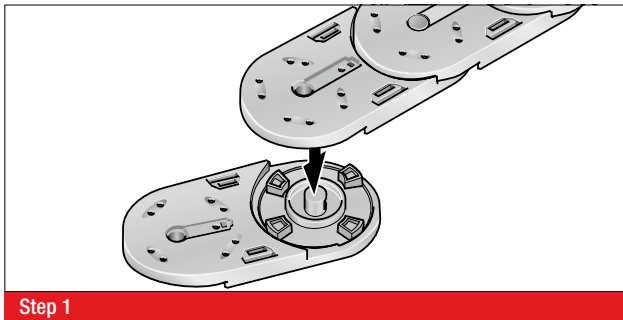

MP 102.2 OPEN

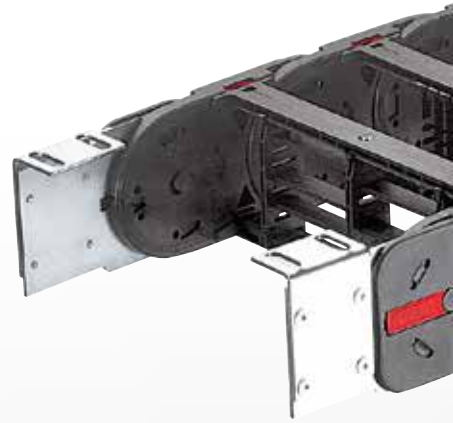

- BROAD INTERIOR LAYOUT
- STEEL CHAIN BRACKET ANGLE
- PLASTIC OR ALUMINUM VERSION
- SIDE LINK LOCK

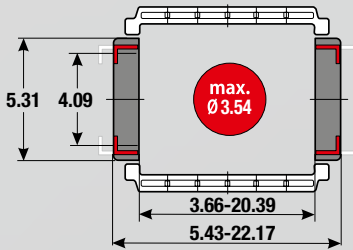

TECHNICAL DATA

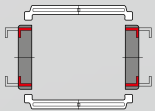

Loading side
Inside and outside bend

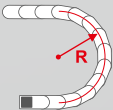

Available radii
9.84 – 19.69 inch

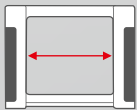

Available interior widths
With plastic crossbar
3.66 – 20.39 inch
With aluminum crossbar / cover
2.83 – 23.62 inch /

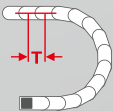

Grid
T = 5.55 inch

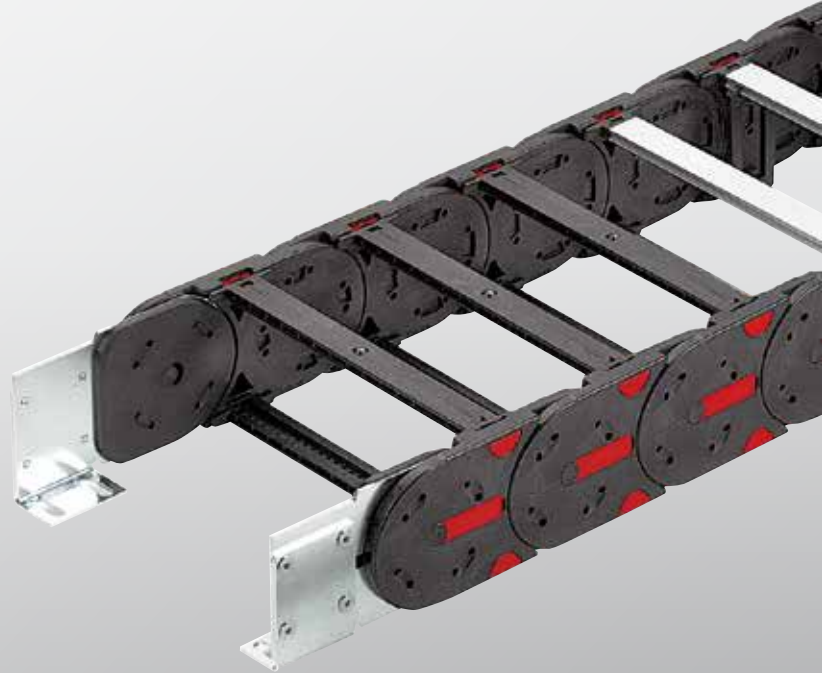



TECHNICAL SPECIFICATIONS

Travel distance gliding L_g max.	492.13 ft.
Travel distance self-supporting L_s max.	see diagram on page 321
Travel distance vertical, hanging L_{vh} max.	262.47 ft.
Travel distance vertical, upright L_{vs} max.	26.25 ft.
Rotated 90°, unsupported L_{90f} max.	26.25 ft.
Speed, gliding V_g max.	16.40 ft/s
Speed, self-supporting V_f max.	65.62 ft/s
Acceleration, gliding a_g max.	82.02 ft/s ²
Acceleration, self-supporting a_s max.	131.23 ft/s ²

Contact our engineering department to meet any higher requirements: efk@murrplastik.de

MATERIAL PROPERTIES

Standard material	Polyamide (PA) black
Service temperature	-22.00 – 248.00 °F
Gliding friction factor	0.30
Static friction factor	0.45
Fire classification	UL 94 HB

Other material properties on request

SHELVING SYSTEM



Separator TR

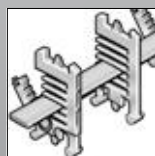

RS shelving system

CHAIN BRACKET

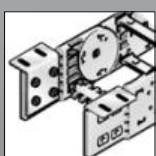

Chain bracket angle



Crossbar connector RSV

ACCESSORIES

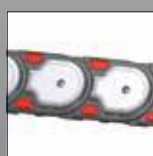

Gliding plate

GUIDE CHANNELS

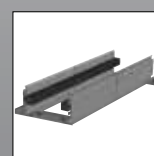

VAW aluminum

STRAIN RELIEF



RS-ZL crossbar strain relief

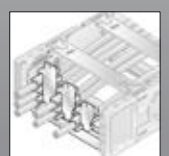

STF Steel Fix

ORDERING KEY

Dimensions in mm [US inch]

Type code	Variation	Inside width	Outside width	Inside width	Outside width	Radius	Rail variant	Material	Chain length
1022 30	Crossbar on outside bend Crossbar on inside bend Opens on inside and outside of bend	093 [3.66]	139 [5.47]	468 [18.43]	514 [20.24]	250 [9.84]	0 Plastic, full-ridged with bias	0 Polyamide (PA): standard (PA/black)	
		106 [4.17]	152 [5.98]	518 [20.39]	564 [22.20]				
		118 [4.65]	164 [6.46]			300 [11.81]	2 Plastic, half-ridged with bias	9 Special version (on request)	
		131 [5.16]	177 [6.97]						
		143 [5.63]	189 [7.44]			400 [15.75]	4 Aluminum full-ridged with bias		
		156 [6.14]	202 [7.95]						
		168 [6.61]	214 [8.43]			500 [19.69]	6 Aluminum half-ridged with bias		
		181 [7.13]	227 [8.94]						
		193 [7.60]	239 [9.41]				9 Special version (on request)		
		206 [8.11]	252 [9.92]						
		218 [8.58]	264 [10.39]						
		231 [9.09]	277 [10.91]						
		243 [9.57]	289 [11.38]						
		256 [10.08]	302 [11.89]						
		268 [10.55]	314 [12.36]						
		293 [11.54]	339 [13.35]						
		318 [12.52]	364 [14.33]						
		343 [13.50]	389 [15.31]						
		368 [14.49]	414 [16.30]						
		418 [16.46]	464 [18.27]						

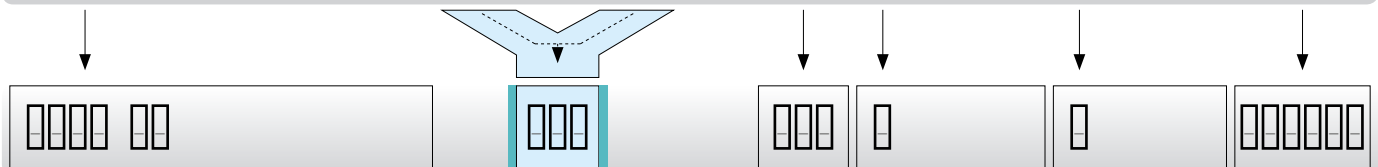

ORDERING EXAMPLE: 1022 118 250 0 0 000077

Crossbar on outside bend, crossbar on inside bend, can be opened from inside and outside bend
 Inside width 4.65 in.; radius 9.84 in.
 Plastic crossbar, full-ridged with bias, material black-colored polyamide
 Chain length 77 in. (14 links)

NOTE ON CONFIGURATION

Aluminum crossbars:

Aluminum crossbars in 0.04 in (1 mm) width sizes for inner widths from 2.83 inch – 23.62 inch are available for delivery.

Strain relief:

The end brackets utilize strain relief plates (ZL) for cable strain relief.

For detailed information, please consult the corresponding product documentation.

SELF-SUPPORTING LENGTH

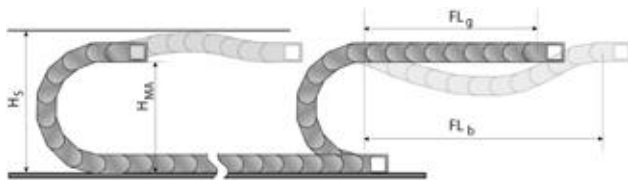

The self-supporting length is the distance between the chain bracket on the moving end and the start of the chain arch. The installation variant FL_g offers the lowest load and wear for the cable drag chain. The maximum travel parameters (speed and acceleration) can be applied for this variant.

- H_s = Installation height plus safety
- H_{MA} = Height of moving end connection
- FL_g = Self-supporting length, upper run straight
- FL_b = Self-supporting length, upper run bent

LOAD DIAGRAM FOR SELF-SUPPORTING APPLICATIONS

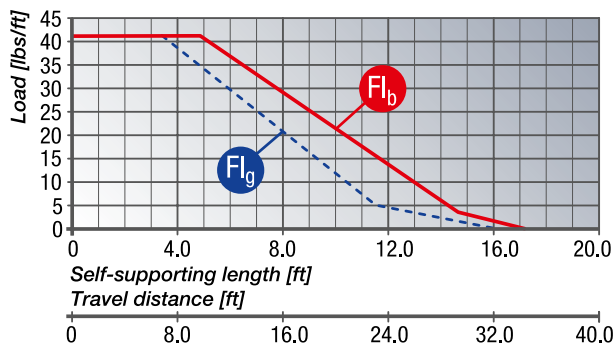

FL_g Self-supporting length, upper run straight

In the FL_g range, the chain upper run still has a bias, is straight or has a maximum sag of 3.15 inch.

FL_b Self-supporting length, upper run bent

In the FL_b range, the chain upper run has a sag of more than 3.15 inch, but this is still less than the maximum sag. Where the sag is greater than that permitted in the FL_b range, the application is critical and should be avoided. The self-supporting length can be optimized by using a support for the upper run or a more stable cable drag chain.

DETERMINING THE CHAIN LENGTH

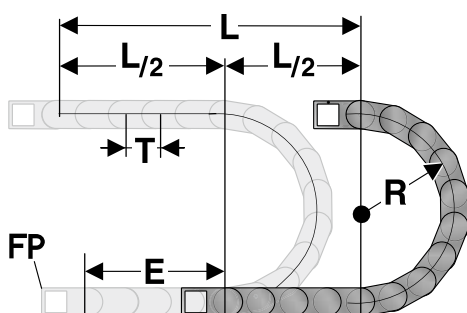

The fixed point of the cable drag chain should be connected in the middle of the travel distance.

This arrangement gives the shortest connection between the fixed point (FP) and the moving bracket and thus the most efficient chain length.

Chain length calculation = $L/2 + \pi * R + E$
 $\approx 1 \text{ ft chain} = 3 \text{ qty.} \times 5.55 \text{ inch.}$

- E = Distance between entry point and middle of travel distance
- L = Travel distance
- R = Radius
- P = Grid 5.55 inch

INSTALLATION DIMENSIONS

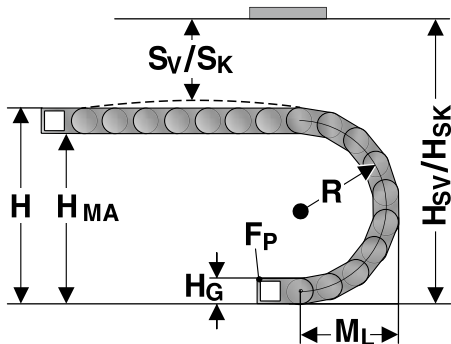

The moving end chain connection is to be screw fixed at height H_{MA} for the respective radius.
For the installed dimension the “Installed height H_S ” value has to be taken into account.

Radius R	9.84	11.81	15.75	19.69
Outside height of chain link (H_G)	5.31	5.31	5.31	5.31
Height of bend (H)	25.77	29.71	37.59	45.47
Height of moving end connection (H_{MA})	20.46	24.40	32.28	40.16
Installation height (H_S)	27.74	31.68	39.56	47.44
Safety margin without bias (S_K)	1.97	1.97	1.97	1.97
Installation height without bias (H_{SK})	27.74	31.68	39.56	47.44
Arc projection (M_L)	18.43	20.41	24.35	28.29

HEAVYLINE PLASTIC CROSSBAR



The crossbars connect the two side runs of the cable drag chain. The crossbar length is synonymous with the inside width of the cable drag chain.

Type	Order No.	Description	Inside width inch
BS 093-7	072009300000	Crossbar	3.66
BS 106-7	072010600000	Crossbar	4.17
BS 118-7	072011800000	Crossbar	4.65
BS 131-7	072013100000	Crossbar	5.16
BS 143-7	072014300000	Crossbar	5.63
BS 156-7	072015600000	Crossbar	6.14
BS 168-7	072016800000	Crossbar	6.61
BS 181-7	072018100000	Crossbar	7.13
BS 193-7	072019300000	Crossbar	7.60
BS 206-7	072020600000	Crossbar	8.11
BS 231-7	072023100000	Crossbar	9.09
BS 243-7	072024300000	Crossbar	9.57
BS 256-7	072025600000	Crossbar	10.08
BS 268-7	072026800000	Crossbar	10.55
BS 293-7	072029300000	Crossbar	11.54
BS 318-7	072031800000	Crossbar	12.52
BS 343-7	072034300000	Crossbar	13.50

HEAVYLINE PLASTIC CROSSBAR

Type	Order No.	Description	Inside width inch
BS 368-7	072036800000	Crossbar	14.49
BS 418-7	072041800000	Crossbar	16.46
BS 468-7	072046800000	Crossbar	18.43
BS 518-7	072051800000	Crossbar	20.39

KA 102 CHAIN BRACKET ANGLE

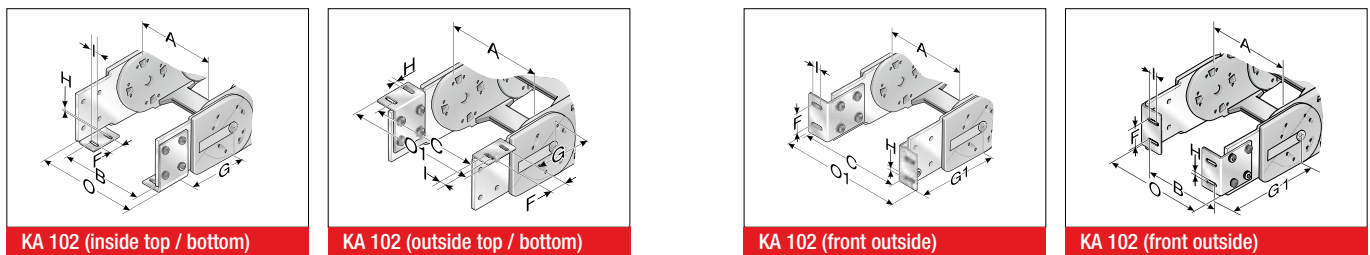

There are several options regarding the chain bracket. The fixed-point bracket (inside/bottom) and the moving end bracket (inside/top) are supplied as standard. However, any other combination can be supplied upon request. The chain bracket

is fastened at the end like a side link. This enables the chain to move right up to the bracket. Each chain requires one male and one female bracket. The brackets should be fastened with M12 screws.

Type	Order No.	Material	Inside width								Outside width of KA 0 inch	Outside width of KA 01 inch
			A inch	B inch	C inch	F inch	G inch	G1 inch	HØ inch	I inch		
KA 102 Female end	1020000050	Sheet steel	3.66 – 20.39	A+0.08	A+1.50	1.97	9.29	12.93	0.51	0.98	A+1.10	A+4.21
KA 102 Male end	1020000051	Sheet steel	3.66 – 20.39	A+0.08	A+1.50	1.97	9.29	12.93	0.51	0.98	A+1.10	A+4.21

GLP 10 (102.2) GLIDING PLATE



The gliding plates are mounted in a horizontal position, with the chain laying on its side, to minimize friction wear to the sides. The gliding plates are placed onto the side links instead of the usual chain link side locks (no tools required). The wear limit is 0.1 in (2.5 mm). We recommend replacing the cable drag chain when this limit has been reached. Depending on the application, the service life of the cable drag chain may be extended two-fold, by using gliding plates. The cable drag chain must be placed on its side before opening.

Type	Order No.	Installation site	Gliding plate height inch
GLP10	102290400301	GLP10 gliding plate for the MP102.2	0.28

TR 102 SEPARATOR

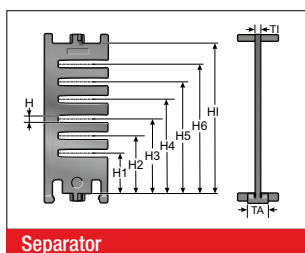

We recommend that separators be used if multiple round cables or conduits with differing diameters are to be installed.

Type	Order No.	Description	Version	TI inch	TA inch	H inch	H1 inch	H2 inch	H3 inch	H4 inch	H5 inch	H6 inch	H1 inch
TR 102	1020000092	Separator	lockable	0.16	0.51	0.22	1.09	1.57	2.06	2.55	3.03	3.52	4.09

RTT 102 SHELF SUPPORT, DIVISIBLE

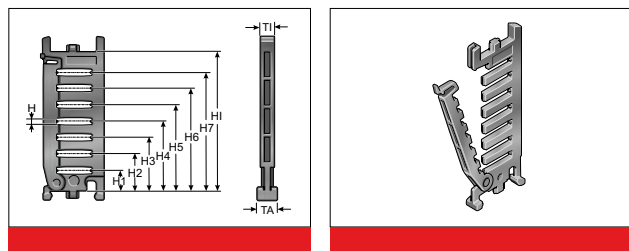

In connection with two separable shelf supports (RTT) with at least one end-to-end shelf (RB) the shelf becomes an easy to fill shelving system. The additional levels prevent cables from criss-crossing and minimize the friction between them.

Type	Order No.	Description	Version	TI inch	TA inch	H inch	H1 inch	H2 inch	H3 inch	H4 inch	H5 inch	H6 inch	H7 inch	HI inch
RTT 102	100091022000	Shelf support, divisible	lockable	0.31	0.31	0.22	0.61	1.09	1.57	2.06	2.55	3.03	3.52	4.09

RB-7 SHELF

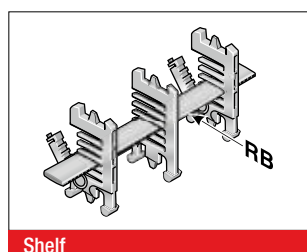

In connection with at least two separable shelf supports (RTT), the shelf becomes a shelving system. The additional levels prevent cables from criss-crossing and minimize the friction between them.

Type	Order No.	Description	Width inch	Inside width inch
RB 056-7	100000005600	Shelf	2.20	3.66
RB 061-7	1000006107	Shelf	2.40	3.66
RB 066-7	100000006600	Shelf	2.60	3.66
RB 071-7	1000007107	Shelf	2.80	3.66
RB 076-7	1000007607	Shelf	2.99	3.66
RB 081-7	10000008100	Shelf	3.19	3.66
RB 086-7	1000008607	Shelf	3.39	3.66
RB 091-7	1000009107	Shelf	3.58	4.17
RB 096-7	1000009607	Shelf	3.78	4.17
RB 101-7	1000010107	Shelf	3.98	4.17
RB 106-7	100000010600	Shelf	4.17	4.17
RB 111-7	1000011107	Shelf	4.37	4.65
RB 116-7	100000011600	Shelf	4.57	4.65
RB 121-7	1000012107	Shelf	4.76	5.16
RB 126-7	1000012607	Shelf	4.96	5.16
RB 131-7	1000013107	Shelf	5.16	5.63
RB 136-7	1000013607	Shelf	5.35	5.63
RB 141-7	1000014107	Shelf	5.55	5.63
RB 146-7	1000014607	Shelf	5.75	6.14
RB 151-7	1000015107	Shelf	5.94	6.14
RB 156-7	1000015607	Shelf	6.14	6.14
RB 161-7	1000016107	Shelf	6.34	6.61
RB 166-7	100000016600	Shelf	6.54	6.61
RB 171-7	1000017107	Shelf	6.73	7.13
RB 176-7	1000017607	Shelf	6.93	7.13
RB 181-7	1000018107	Shelf	7.13	7.60
RB 186-7	1000018607	Shelf	7.32	7.60

RB-7 SHELF

Type	Order No.	Description	Width inch	Inside width inch
RB 191-7	1000019107	Shelf	7.52	7.60
RB 196-7	1000019607	Shelf	7.72	8.11
RB 201-7	1000020107	Shelf	7.91	8.11
RB 206-7	1000020607	Shelf	8.11	8.11
RB 211-7	1000021107	Shelf	8.31	8.58
RB 216-7	100000021600	Shelf	8.50	8.58

RSV 102 CROSSBAR CONNECTOR



For crossbars wider than 9.69 inch (246 mm), we recommend the use of crossbar connectors. These prevent deformation to the crossbar under large amounts of additional weight of the chain assembly.

Type	Order No.	Description	TI inch
RSV 102	1020000096	Crossbar connector	0.31
RSV 102 Alu	1020000098	Crossbar connector for aluminum crossbars	0.31

RS-ZL CROSSBAR STRAIN RELIEF PLATE MP102.2

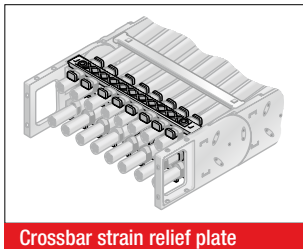

Type	Order No.	Description	Inside width inch
RS-ZL 093-7 MP102.2	80980291	Crossbar strain relief plate	3.66
RS-ZL 106-7 MP102.2	80980292	Crossbar strain relief plate	4.17
RS-ZL 118-7 MP102.2	80980204	Crossbar strain relief plate	4.65
RS-ZL 131-7 MP102.2	80980293	Crossbar strain relief plate	5.16
RS-ZL 143-7 MP102.2	80980160	Crossbar strain relief plate	5.63
RS-ZL 156-7 MP102.2	80980294	Crossbar strain relief plate	6.14
RS-ZL 168-7 MP102.2	80980205	Crossbar strain relief plate	6.61
RS-ZL 181-7 MP102.2	80980295	Crossbar strain relief plate	7.13
RS-ZL 193-7 MP102.2	80980206	Crossbar strain relief plate	7.60
RS-ZL 206-7 MP102.2	80980296	Crossbar strain relief plate	8.11
RS-ZL 218-7 MP102.2	80980207	Crossbar strain relief plate	8.58
RS-ZL 231-7 MP102.2	80980297	Crossbar strain relief plate	9.09
RS-ZL 243-7 MP102.2	80980208	Crossbar strain relief plate	9.57
RS-ZL 256-7 MP102.2	80980298	Crossbar strain relief plate	10.08

STRAIN RELIEF WITH STEEL FIX

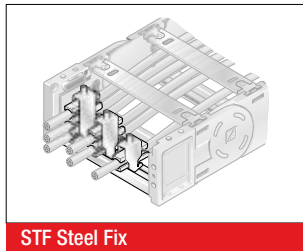
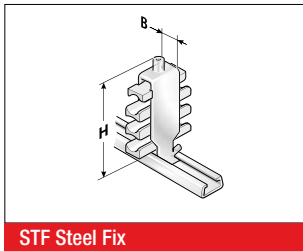

C-rails (galvanized) for permanent integration, for accommodating the Steel Fix bow clamps in the chain brackets. The bow clamps can take up to 3 cables and are suitable for C-rails with a groove width of 0.43 in (11 mm). Due to the design of the trough elements, a cable preserving cable guidance is ensured. May be assembled on the inside and outside bends at both chain endings. The overall height stated is a guide only. The actual height is, amongst other things, dependent on the diameter and the quality of the cable. A safety distance of 0.39 in (10 mm) at the fixed point above the strain relief must be kept during gliding applications.

Type	Order No.	Description	Seats qty.	Cable Ø inch	Width (B) inch	Total height (H) inch
Single clamp (for one cable)						
STF 12-1 Steel Fix	81661801	Hooped clamp	1	0.24 – 0.47	0.63	2.17
STF 14-1 Steel Fix	81661802	Hooped clamp	1	0.47 – 0.55	0.71	2.05
STF 16-1 Steel Fix	81661803	Hooped clamp	1	0.55 – 0.63	0.79	2.13
STF 18-1 Steel Fix	81661804	Hooped clamp	1	0.63 – 0.71	0.87	2.20
STF 20-1 Steel Fix	81661805	Hooped clamp	1	0.71 – 0.79	0.94	2.32
STF 22-1 Steel Fix	81661806	Hooped clamp	1	0.79 – 0.87	1.02	2.40
STF 26-1 Steel Fix	81661807	Hooped clamp	1	0.87 – 1.02	1.18	2.76
STF 30-1 Steel Fix	81661808	Hooped clamp	1	1.02 – 1.18	1.34	2.91
STF 34-1 Steel Fix	81661809	Hooped clamp	1	1.18 – 1.34	1.50	3.07
STF 38-1 Steel Fix	81661810	Hooped clamp	1	1.34 – 1.50	1.65	3.23
STF 42-1 Steel Fix	81661811	Hooped clamp	1	1.50 – 1.65	1.81	3.58
Double clamp (for two cables)						
STF 12-2 Steel Fix	81661821	Hooped clamp	2	0.24 – 0.47	0.63	2.87
STF 14-2 Steel Fix	81661822	Hooped clamp	2	0.47 – 0.55	0.71	2.91
STF 16-2 Steel Fix	81661823	Hooped clamp	2	0.55 – 0.63	0.79	3.23
STF 18-2 Steel Fix	81661824	Hooped clamp	2	0.63 – 0.71	0.87	3.39
STF 20-2 Steel Fix	81661825	Hooped clamp	2	0.71 – 0.79	0.94	3.58
STF 22-2 Steel Fix	81661826	Hooped clamp	2	0.79 – 0.87	1.02	3.74
STF 26-2 Steel Fix	81661827	Hooped clamp	2	0.87 – 1.02	1.18	4.25
STF 30-2 Steel Fix	81661828	Hooped clamp	2	1.02 – 1.18	1.34	4.76
STF 34-2 Steel Fix	81661829	Hooped clamp	2	1.18 – 1.34	1.50	5.08
Triple clamp (for three cables)						
STF 12-3 Steel Fix	81661841	Hooped clamp	3	0.24 – 0.47	0.63	3.86
STF 14-3 Steel Fix	81661842	Hooped clamp	3	0.47 – 0.55	0.71	3.86
STF 16-3 Steel Fix	81661843	Hooped clamp	3	0.55 – 0.63	0.79	4.13
STF 18-3 Steel Fix	81661844	Hooped clamp	3	0.63 – 0.71	0.87	4.37
STF 20-3 Steel Fix	81661845	Hooped clamp	3	0.71 – 0.79	0.94	4.65
STF 22-3 Steel Fix	81661846	Hooped clamp	3	0.79 – 0.87	1.02	5.12

MP 102.2 LOWERED FIXING POINT

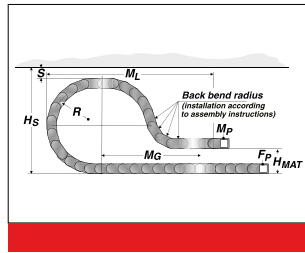
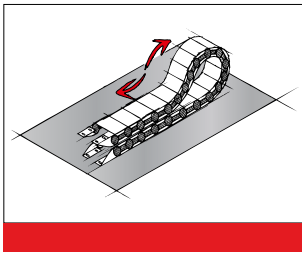

It is sometimes necessary to lower the height of the moving attachment point.
 In such cases, modifications to the chain layout should be noted (e.g. extension of chain).
 Please contact our application engineers.

9.84	9.84	2.36	27.36	34.65	9	3
11.81	10.63	2.36	31.30	40.16	10	3
15.75	15.35	2.36	39.17	48.03	12	3
19.69	16.54	2.36	47.24	58.66	15	3

MP 102 REARWARD RADII

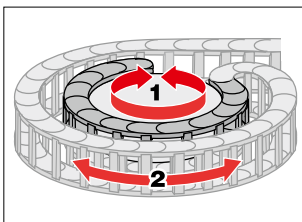

Rotating movement

Side links with forward radius (R) and rearward radius (Rü) allow movements in both directions. This is intended for rotating movements and lowered chain brackets. Note: This type of chain has different chain links for the left or right side! Rotation movements are only possible with open variants.

Type	Order No.	Radius inch	Back radius inch
SR 102 (RÜ400/R400) left	10200040060	15.75	15.75
SR 102 (RÜ400/R400) right	10200040062	15.75	15.75

VAW GUIDE CHANNEL

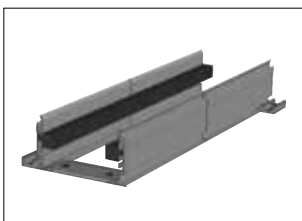

VAW aluminum

A variable guide channel system, constructed from aluminum sections, is available for this cable drag chain. The variable guide channel ensures that the cable drag chain is supported and guided securely.

ASSEMBLY

DISASSEMBLY

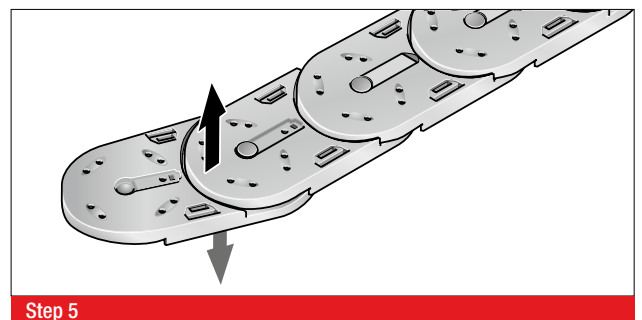
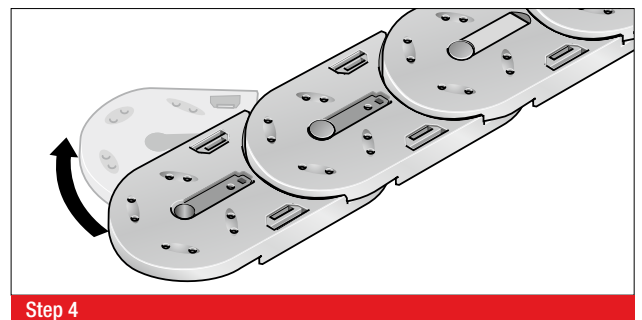
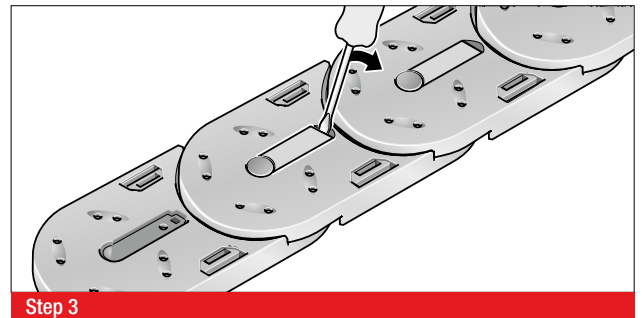
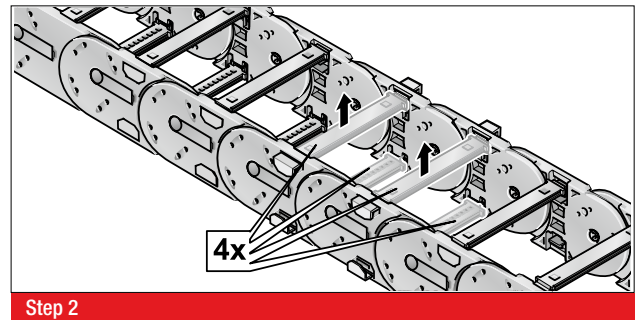
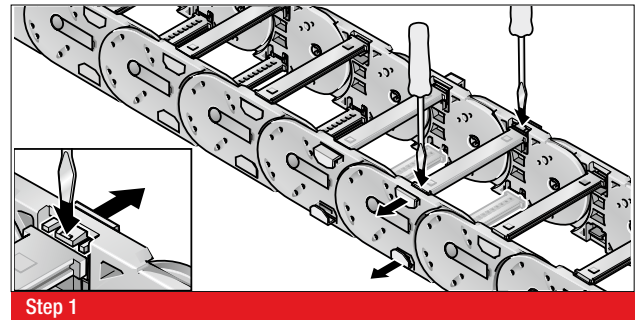
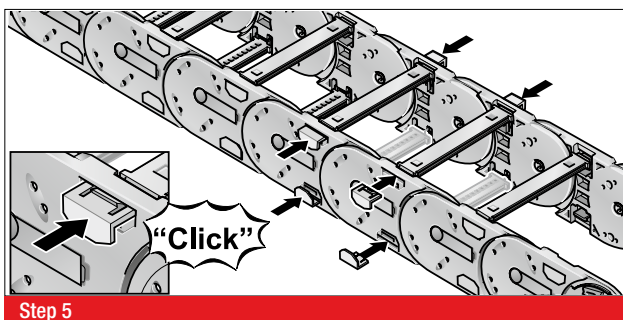
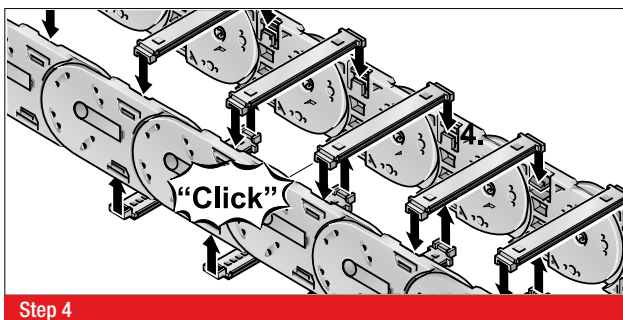
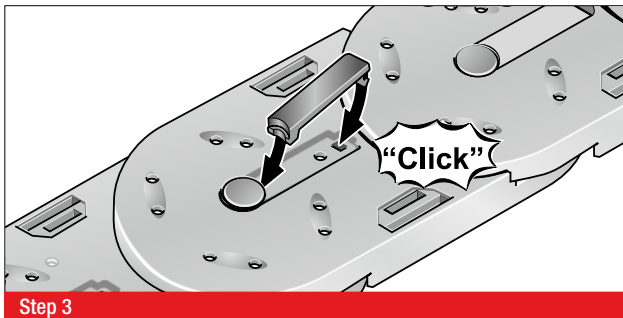
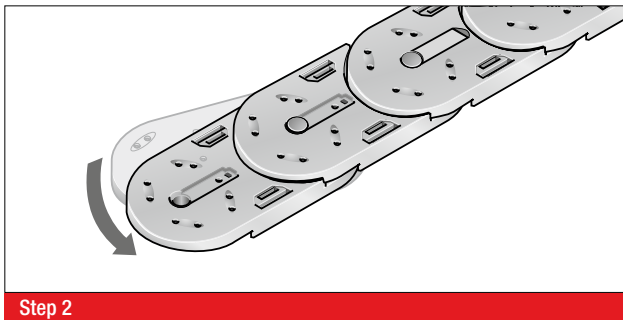
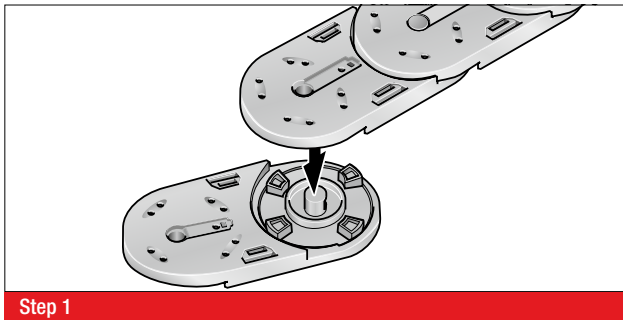

MP 32 OPEN



- PLASTIC OR ALUMINUM VERSION
- CHAIN BRACKET FLEXIBLE
- BROAD INTERIOR LAYOUT

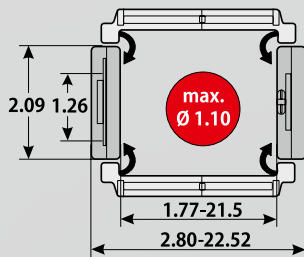

TECHNICAL DATA

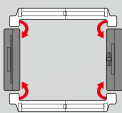

Loading side
Inside and outside bend

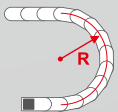

Available radii
3.15 – 9.84 inch

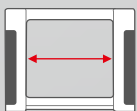

Available interior widths
With plastic crossbar
1.77 – 21.5 inch
With aluminum crossbar / cover
2.64 – 23.62 inch /

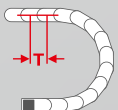

Grid
T = 2.54 inch

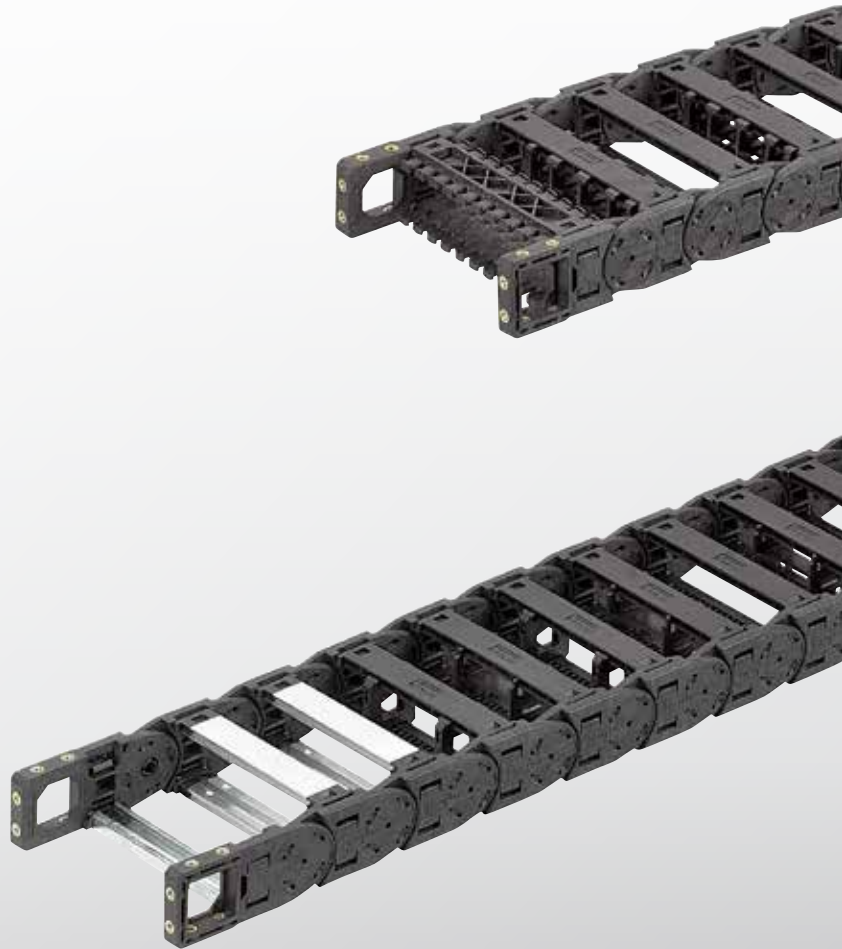



TECHNICAL SPECIFICATIONS

Travel distance gliding L_g max.	328.08 ft.
Travel distance self-supporting L_s max.	see diagram on page 333
Travel distance vertical, hanging L_{vh} max.	131.23 ft.
Travel distance vertical, upright L_{vs} max.	16.40 ft.
Rotated 90°, unsupported L_{90f} max.	6.56 ft.
Speed, gliding V_g max.	16.40 ft/s
Speed, self-supporting V_f max.	65.62 ft/s
Acceleration, gliding a_g max.	82.02 ft/s ²
Acceleration, self-supporting a_s max.	98.43 ft/s ²

Contact our engineering department to meet any higher requirements: efk@murrplastik.de

MATERIAL PROPERTIES

Standard material	Polyamide (PA) black
Service temperature	-22.00 – 248.00 °F
Gliding friction factor	0.30
Static friction factor	0.45
Fire classification	UL 94 HB

Other material properties on request

SHELVING SYSTEM



Separator TR

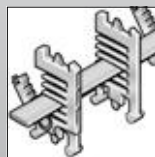

RS shelving system



Crossbar connector RSV

CHAIN BRACKET

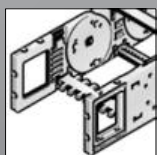

Chain bracket flexible

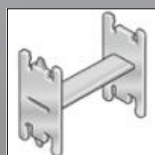

H-shaped shelf unit RE

ACCESSORIES



Bracket bar

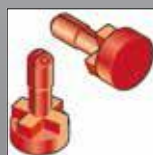

Lock button

GUIDE CHANNELS



VAW steel galvanized / stainless steel

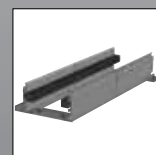

VAW aluminum

STRAIN RELIEF

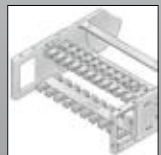

RS-ZL crossbar strain relief

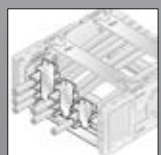

STF Steel Fix

ORDERING KEY

Type code	Variation	Inside width	Outside width	Inside width	Outside width	Radius	Rail variant	Material	Chain length
0320 30	Crossbar on outside bend Crossbar on inside bend Opens on inside and outside of bend	045 [1.77]	071 [2.80]	233 [9.17]	259 [10.20]	080 [3.15]	0 Plastic, full-ridged with bias	0 Polyamide (PA): standard (PA/black)	
		057 [2.24]	083 [3.27]	246 [9.69]	272 [10.71]				
		062 [2.44]	088 [3.46]	252 [9.92]	278 [10.94]	100 [3.94]	2 Plastic, half-ridged with bias	9 Special version (on request)	
		071 [2.80]	097 [3.82]	258 [10.16]	284 [11.18]				
		084 [3.31]	110 [4.33]	296 [11.65]	322 [12.68]	120 [4.72]	4 Aluminum full-ridged with bias		
		093 [3.66]	119 [4.69]	346 [13.62]	372 [14.65]				
		096 [3.78]	122 [4.80]	350 [13.78]	376 [14.80]	150 [5.91]	6 Aluminum half-ridged with bias		
		104 [4.09]	130 [5.12]	358 [14.09]	384 [15.12]				
		107 [4.21]	133 [5.24]	371 [14.61]	397 [15.63]	200 [7.87]	9 Special version (on request)		
		121 [4.76]	147 [5.79]	396 [15.59]	422 [16.61]				
		133 [5.24]	159 [6.26]	421 [16.57]	447 [17.60]	250 [9.84]			
		144 [5.67]	170 [6.69]	446 [17.56]	472 [18.58]				
		146 [5.75]	172 [6.77]	496 [19.53]	522 [20.55]				
		158 [6.22]	184 [7.24]	546 [21.50]	572 [22.52]				
		164 [6.46]	190 [7.48]						
		171 [6.73]	197 [7.76]						
		182 [7.17]	208 [8.19]						
		196 [7.72]	222 [8.74]						
		208 [8.19]	234 [9.21]						
		220 [8.66]	246 [9.69]						

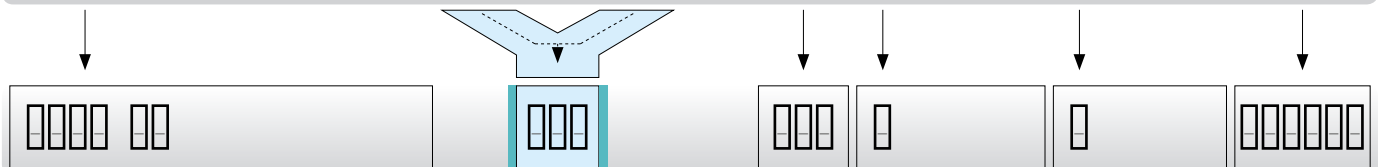

ORDERING EXAMPLE: 0320 045 080 0 0 000050

Crossbar on outside bend, crossbar on inside bend, can be opened from inside and outside bend
 Inside width 1.77 in.; radius 3.15 in.
 Plastic crossbar, full-ridged with bias, material black-colored polyamide
 Chain length 50 in. (20 links)

NOTE ON CONFIGURATION

Aluminum crossbars:

Aluminum crossbars in 0.04 in (1 mm) width sizes for inner widths from 2.64 inch – 23.62 inch are available for delivery.

Crossbar connector and crossbar strain relief plate:

Once inside widths exceed 9.69 inches (246 mm), we recommend the deployment of crossbar connectors (RSV). If crossbar strain relief plates (RS-ZL) are to be deployed in the chain brackets, take standard inside widths into account.

For detailed information, please consult the corresponding product documentation.

SELF-SUPPORTING LENGTH

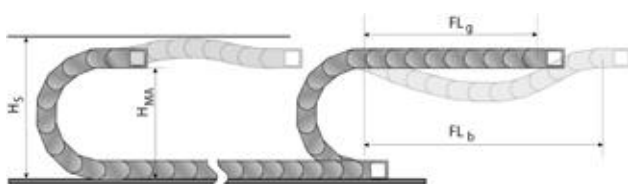

The self-supporting length is the distance between the chain bracket on the moving end and the start of the chain arch. The installation variant FL_g offers the lowest load and wear for the cable drag chain. The maximum travel parameters (speed and acceleration) can be applied for this variant.

- H_S = Installation height plus safety
- H_{MA} = Height of moving end connection
- FL_g = Self-supporting length, upper run straight
- FL_b = Self-supporting length, upper run bent

LOAD DIAGRAM FOR SELF-SUPPORTING APPLICATIONS

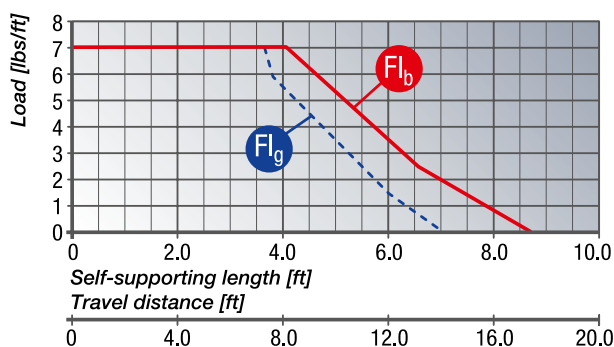

FL_g Self-supporting length, upper run straight

In the FL_g range, the chain upper run still has a bias, is straight or has a maximum sag of 2.76 inch.

FL_b Self-supporting length, upper run bent

In the FL_b range, the chain upper run has a sag of more than 2.76 inch, but this is still less than the maximum sag. Where the sag is greater than that permitted in the FL_b range, the application is critical and should be avoided. The self-supporting length can be optimized by using a support for the upper run or a more stable cable drag chain.

DETERMINING THE CHAIN LENGTH

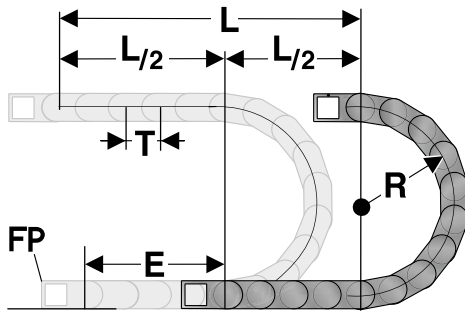

The fixed point of the cable drag chain should be connected in the middle of the travel distance. This arrangement gives the shortest connection between the fixed point (FP) and the moving bracket and thus the most efficient chain length.

Chain length calculation = $L/2 + \pi * R + E$
 $\approx 1 \text{ ft chain} = 16 \text{ qty.} \times 2.54 \text{ inch.}$

- E = Distance between entry point and middle of travel distance
- L = Travel distance
- R = Radius
- P = Grid 2.54 inch

INSTALLATION DIMENSIONS

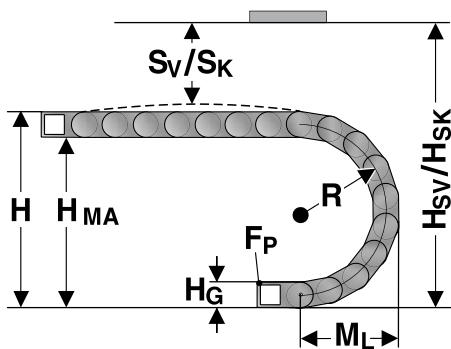

The moving end chain connection is to be screw fixed at height H_{MA} for the respective radius. For the installed dimension the "Installed height H_s " value has to be taken into account.

Radius R	3.15	3.94	4.72	5.91	7.87	9.84
Outside height of chain link (H_o)	2.09	2.09	2.09	2.09	2.09	2.09
Height of bend (H)	9.17	10.75	12.31	14.69	18.61	22.55
Height of moving end connection (H_{MA})	7.08	8.66	10.22	12.60	16.52	20.46
Safety margin (S)	1.18	1.18	1.18	1.18	1.18	1.18
Installation height (H_s)	10.35	11.93	13.49	15.87	19.79	23.73
Arc projection (M_L)	7.13	7.92	8.70	9.89	11.85	13.82

POWERLINE PLASTIC CROSSBAR

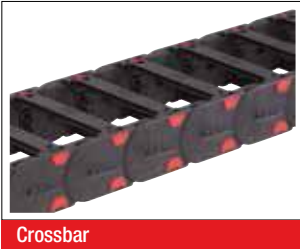

The crossbars connect the two side runs of the cable drag chain. The crossbar length is synonymous with the inside width of the cable drag chain.

Type	Order No.	Description	Inside width inch
BS 045-5	052004500000	Crossbar	1.77
BS 057-5	052005700000	Crossbar	2.24
BS 062-5	052006200000	Crossbar	2.44
BS 071-5	052007100000	Crossbar	2.80
BS 084-5	052008400000	Crossbar	3.31
BS 093-5	052009300000	Crossbar	3.66
BS 096-5	052009600000	Crossbar	3.78
BS 104-5	052010400000	Crossbar	4.09
BS 107-5	052010700000	Crossbar	4.21
BS 121-5	052012100000	Crossbar	4.76
BS 133-5	052013300000	Crossbar	5.24
BS 144-5	052014400000	Crossbar	5.67
BS 146-5	052014600000	Crossbar	5.75
BS 158-5	052015800000	Crossbar	6.22
BS 164-5	052016400000	Crossbar	6.46
BS 171-5	052017100000	Crossbar	6.73
BS 182-5	052018200000	Crossbar	7.17
BS 196-5	052019600000	Crossbar	7.72
BS 208-5	052020800000	Crossbar	8.19
BS 220-5	052022000000	Crossbar	8.66
BS 233-5	052023300000	Crossbar	9.17
BS 246-5	052024600000	Crossbar	9.69
BS 252-5	052025200010	Crossbar	9.92
BS 258-5	052025800000	Crossbar	10.16
BS 296-5	052029600000	Crossbar	11.65
BS 346-5	052034600000	Crossbar	13.62
BS 350-5	052035000000	Crossbar	13.78
BS 358-5	052035800000	Crossbar	14.09
BS 371-5	052037100000	Crossbar	14.61
BS 396-5	052039600000	Crossbar	15.59
BS 421-5	052042100000	Crossbar	16.57
BS 446-5	052044600000	Crossbar	17.56
BS 496-5	052049600000	Crossbar	19.53
BS 546-5	052054600000	Crossbar	21.50

KA 32 CHAIN BRACKET FLEXIBLE

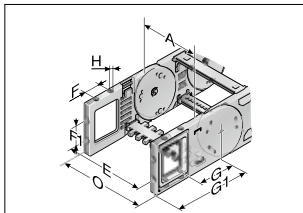

KA 32-F.

This chain bracket offers universal connection options (top, bottom and front) and is attached to the ends of the chain like a side link. This allows the chain to move right up to the bracket. Each chain requires one male and one female bracket. M5 screws are used to secure the brackets in place. Extrusion-coated metal bushes with either a through-hole (-FB) or a threaded hole (-FG) ensure the permanent, high-strength transmission of even extreme forces onto the cable drag chain.

Type	Order No.	Material	Version	Inside width A inch	E inch	F inch	F1 inch	G inch	G1 inch	H inch	H0 inch	Outside width of KA 0 inch
KA 32-FB	0321000054	Plastic	with bush	1.77 – 21.50	A+0.55	0.89	0.87	2.28	3.76		0.22	A+1.10
KA 32-FG	0321000055	Plastic	with thread	1.77 – 21.50	A+0.55	0.89	0.87	2.28	3.76	M5		A+1.10

TR 32 SEPARATOR

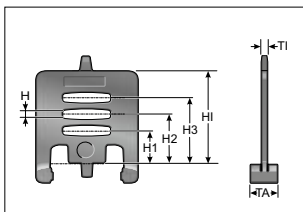

Separator

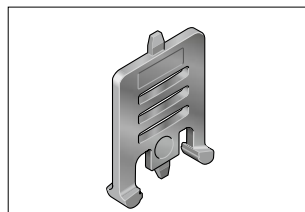

We recommend that separators be used if multiple round cables or conduits with differing diameters are to be installed.

Type	Order No.	Description	Version	TI inch	TA inch	H inch	H1 inch	H2 inch	H3 inch	HI inch
TR 32	032000009200	Separator	lockable	0.12	0.39	0.17	0.41	0.64	0.87	1.26

TR 32.1 SEPARATOR

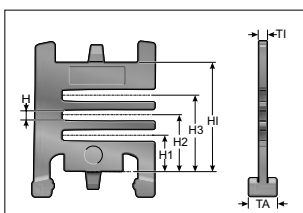

Separator

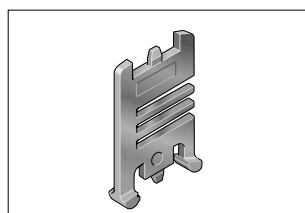

We recommend that separators be used if multiple round cables or conduits with differing diameters are to be installed.

Type	Order No.	Description	Version	TI inch	TA inch	H inch	H1 inch	H2 inch	H3 inch	HI inch
TR 32.1	032200009200	Separator	lockable	0.14	0.31	0.16	0.41	0.65	0.89	1.26

RTT 32 SHELF SUPPORT, DIVISIBLE

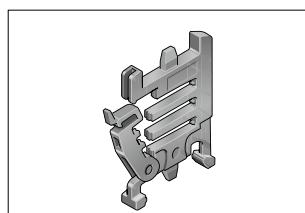
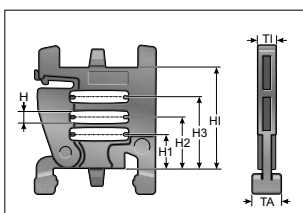

In connection with two separable shelf supports (RTT) with at least one end-to-end shelf (RB) the shelf becomes an easy to fill shelving system. The additional levels prevent cables from criss-crossing and minimize the friction between them.

Type	Order No.	Description	Version	TI inch	TA inch	H inch	H1 inch	H2 inch	H3 inch	HI inch
RTT 32	100090322000	Shelf support, divisible	lockable	0.28	0.31	0.16	0.41	0.65	0.89	1.26

RB-5 SHELF

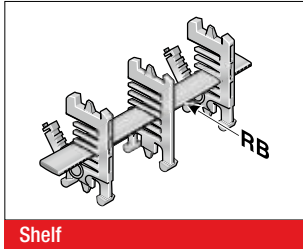

In connection with at least two separable shelf supports (RTT), the shelf becomes a shelving system. The additional levels prevent cables from criss-crossing and minimize the friction between them.

Type	Order No.	Description	Width inch	Inside width inch
RB 028-5	100000002800	Shelf	1.10	1.77
RB 034-5	1000003405	Shelf	1.32	1.77
RB 039-5	1000003905	Shelf	1.54	1.77
RB 045-5	1000004505	Shelf	1.76	2.24
RB 050-5	1000005005	Shelf	1.98	2.24
RB 056-5	100000005601	Shelf	2.20	2.44
RB 062-5	1000006205	Shelf	2.43	2.44
RB 067-5	1000006705	Shelf	2.65	3.31
RB 073-5	1000007305	Shelf	2.87	3.31
RB 078-5	1000007805	Shelf	3.09	3.31
RB 084-5	100000008400	Shelf	3.31	3.31
RB 090-5	1000009005	Shelf	3.53	3.78
RB 095-5	1000009505	Shelf	3.75	3.78
RB 101-5	1000010105	Shelf	3.97	4.21
RB 106-5	1000010605	Shelf	4.19	4.21
RB 112-5	100000011200	Shelf	4.41	4.76
RB 118-5	1000011805	Shelf	4.63	4.76
RB 123-5	1000012305	Shelf	4.85	5.24
RB 129-5	1000012905	Shelf	5.07	5.24
RB 134-5	1000013405	Shelf	5.29	5.67
RB 140-5	100000014000	Shelf	5.51	5.67
RB 146-5	1000014605	Shelf	5.73	6.22
RB 151-5	1000015105	Shelf	5.95	6.22
RB 157-5	1000015705	Shelf	6.17	6.46
RB 162-5	1000016205	Shelf	6.39	6.46
RB 168-5	100000016800	Shelf	6.61	7.17
RB 174-5	1000017405	Shelf	6.83	7.17
RB 179-5	1000017905	Shelf	7.06	7.72
RB 185-5	1000018505	Shelf	7.28	7.72
RB 190-5	1000019005	Shelf	7.50	7.72
RB 196-5	100000019600	Shelf	7.72	7.72
RB 291-5	100000029100	Shelf	11.46	13.62

RSV 32 CROSSBAR CONNECTOR



For crossbars wider than 9.69 inch (246 mm), we recommend the use of crossbar connectors. These prevent deformation to the crossbar under large amounts of additional weight of the chain assembly.

Type	Order No.	Description	TI inch
RSV 32	032000009600	Crossbar connector	0.30
RSV 32 Alu	032000009800	Crossbar connector for aluminum crossbars	0.30

RE 32 H-SHAPED SHELF UNIT

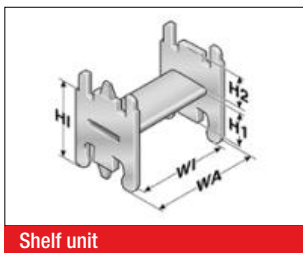

One-piece shelving system, the shelf cannot be varied in height.

Type	Order No.	Description	WA inch	WI inch	H1 inch	H2 inch	H3 inch
RE 32/35	100000322010	H-shaped shelf unit	1.70	1.39	0.56	0.56	1.28
RE 32/52	100000323510	H-shaped shelf unit	2.36	2.05	0.56	0.56	1.28
RE 32/75	100000327510	H-shaped shelf unit	3.24	2.93	0.65	0.47	1.28

BS-5 BRACKET BAR



Large-diameter conduits are routed securely by using bracket bars (BS). This bar is installed on the crossbars or the covers of the cable drag chain. The bracket bar can be installed on both the inside and outside bend.

The bracket bar support (BSH) is used to attach the bars to PowerLine series crossbars. Two bracket bar supports are required for each bar.

Type	Order No.	Description	Conduit diameter max. inch	Installation height inch	Inner chain width min. inch
BS 120-5	052412000000	Bracket bar	4.53	5.51	6.46
BS 153-5	052415300000	Bracket bar	5.83	6.69	8.19
BS 187-5	052418700000	Bracket bar	7.17	8.07	9.17
BSH-5	052400000000	Bracket bar support			
Assembly set	052400000001	Assembly set			

RS-ZL-5 CROSSBAR STRAIN RELIEF PLATE

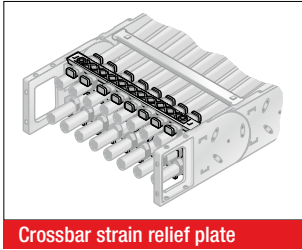

Crossbar strain relief plate

Fixed integrated crossbar strain relief plates in the chain brackets. Tailored to all crossbar widths up to 9.69 inch (246 mm). May be assembled on the inside and outside bends at both chain endings.

Type	Order No.	Description	Inside width inch
RS-ZL 045-5	052004500010	Crossbar strain relief plate	1.77
RS-ZL 057-5	052005700010	Crossbar strain relief plate	2.24
RS-ZL 062-5	052006200010	Crossbar strain relief plate	2.44
RS-ZL 071-5	052007100010	Crossbar strain relief plate	2.80
RS-ZL 084-5	052008400010	Crossbar strain relief plate	3.31
RS-ZL 093-5	052009300010	Crossbar strain relief plate	3.66
RS-ZL 096-5	052009600010	Crossbar strain relief plate	3.78
RS-ZL 104-5	052010400010	Crossbar strain relief plate	4.09
RS-ZL 107-5	052010700010	Crossbar strain relief plate	4.21
RS-ZL 121-5	052012100010	Crossbar strain relief plate	4.76
RS-ZL 133-5	052013300010	Crossbar strain relief plate	5.24
RS-ZL 144-5	052014400010	Crossbar strain relief plate	5.67
RS-ZL 146-5	052014600010	Crossbar strain relief plate	5.75
RS-ZL 158-5	052015800010	Crossbar strain relief plate	6.22
RS-ZL 164-5	052016400010	Crossbar strain relief plate	6.46
RS-ZL 171-5	052017100010	Crossbar strain relief plate	6.73
RS-ZL 182-5	052018200010	Crossbar strain relief plate	7.17
RS-ZL 196-5	052019600010	Crossbar strain relief plate	7.72
RS-ZL 208-5	052020800010	Crossbar strain relief plate	8.19
RS-ZL 220-5	052022000010	Crossbar strain relief plate	8.66
RS-ZL 233-5	052023300010	Crossbar strain relief plate	9.17
RS-ZL 246-5	052024600010	Crossbar strain relief plate	9.69

STRAIN RELIEF WITH STEEL FIX

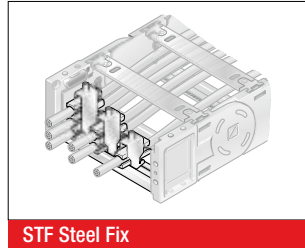
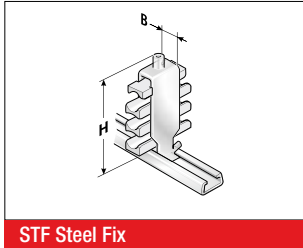

C-rails (galvanized) for permanent integration, for accommodating the Steel Fix bow clamps in the chain brackets. The bow clamps can take up to 3 cables and are suitable for C-rails with a groove width of 0.43 in (11 mm). Due to the design of the trough elements, a cable preserving cable guidance is ensured. May be assembled on the inside and outside bends at both chain endings. The overall height stated is a guide only. The actual height is, amongst other things, dependent on the diameter and the quality of the cable. A safety distance of 0.39 in (10 mm) at the fixed point above the strain relief must be kept during gliding applications.

Type	Order No.	Description	Seats qty.	Cable Ø inch	Width (B) inch	Total height (H) inch
Single clamp (for one cable)						
STF 12-1 Steel Fix	81661801	Hooped clamp	1	0.24 – 0.47	0.63	2.17
STF 14-1 Steel Fix	81661802	Hooped clamp	1	0.47 – 0.55	0.71	2.05
STF 16-1 Steel Fix	81661803	Hooped clamp	1	0.55 – 0.63	0.79	2.13
STF 18-1 Steel Fix	81661804	Hooped clamp	1	0.63 – 0.71	0.87	2.20
STF 20-1 Steel Fix	81661805	Hooped clamp	1	0.71 – 0.79	0.94	2.32
STF 22-1 Steel Fix	81661806	Hooped clamp	1	0.79 – 0.87	1.02	2.40
STF 26-1 Steel Fix	81661807	Hooped clamp	1	0.87 – 1.02	1.18	2.76
STF 30-1 Steel Fix	81661808	Hooped clamp	1	1.02 – 1.18	1.34	2.91
STF 34-1 Steel Fix	81661809	Hooped clamp	1	1.18 – 1.34	1.50	3.07
STF 38-1 Steel Fix	81661810	Hooped clamp	1	1.34 – 1.50	1.65	3.23
STF 42-1 Steel Fix	81661811	Hooped clamp	1	1.50 – 1.65	1.81	3.58
Double clamp (for two cables)						
STF 12-2 Steel Fix	81661821	Hooped clamp	2	0.24 – 0.47	0.63	2.87
STF 14-2 Steel Fix	81661822	Hooped clamp	2	0.47 – 0.55	0.71	2.91
STF 16-2 Steel Fix	81661823	Hooped clamp	2	0.55 – 0.63	0.79	3.23
STF 18-2 Steel Fix	81661824	Hooped clamp	2	0.63 – 0.71	0.87	3.39
STF 20-2 Steel Fix	81661825	Hooped clamp	2	0.71 – 0.79	0.94	3.58
STF 22-2 Steel Fix	81661826	Hooped clamp	2	0.79 – 0.87	1.02	3.74
STF 26-2 Steel Fix	81661827	Hooped clamp	2	0.87 – 1.02	1.18	4.25
STF 30-2 Steel Fix	81661828	Hooped clamp	2	1.02 – 1.18	1.34	4.76
STF 34-2 Steel Fix	81661829	Hooped clamp	2	1.18 – 1.34	1.50	5.08
Triple clamp (for three cables)						
STF 12-3 Steel Fix	81661841	Hooped clamp	3	0.24 – 0.47	0.63	3.86
STF 14-3 Steel Fix	81661842	Hooped clamp	3	0.47 – 0.55	0.71	3.86
STF 16-3 Steel Fix	81661843	Hooped clamp	3	0.55 – 0.63	0.79	4.13
STF 18-3 Steel Fix	81661844	Hooped clamp	3	0.63 – 0.71	0.87	4.37
STF 20-3 Steel Fix	81661845	Hooped clamp	3	0.71 – 0.79	0.94	4.65
STF 22-3 Steel Fix	81661846	Hooped clamp	3	0.79 – 0.87	1.02	5.12

MP 32/41 LOCK BUTTON

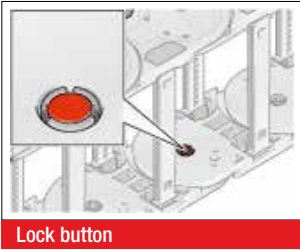

Lock button

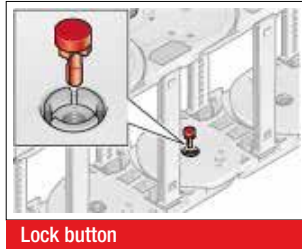

Lock button

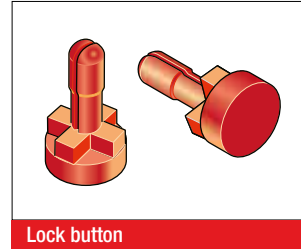

Lock button

To increase the side stability we recommend the use of lock buttons during strong lateral acceleration or when installed “laying

on the side (turned 90°) without support”.

Type	Order No.
MP32/41 lock button	041000008000

MP 32 LOWERED FIXING POINT

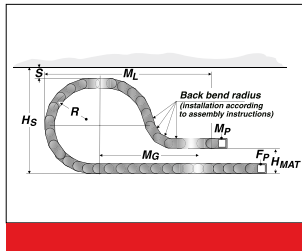
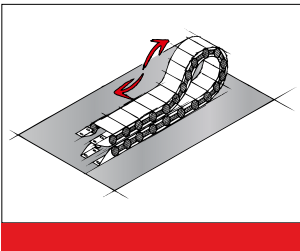

It is sometimes necessary to lower the height of the moving attachment point. In such cases, modifications to the chain layout should be noted (e.g. extension of chain). Please contact our application engineers.

Radius R inch	Height of moving end connection (H_{MA}) inch	Safety margin (S) inch	Installation height incl. safety (S_h) inch	Projection (M_1) inch	Additional links qty.	of which additional back chain links qty.
7.87	8.27	1.97	20.59	28.35	14	3
9.84	9.06	1.97	24.53	34.65	17	3

MP 32 REARWARD RADII

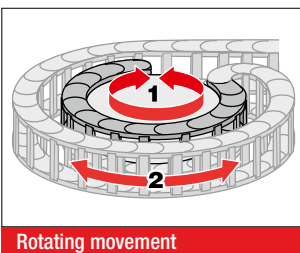

Rotating movement

Side links with forward radius (R) and rearward radius ($Rü$) allow movements in both directions. This is intended for rotating movements and lowered chain brackets. Rotation movements are only possible with open variants.

Type	Order No.	Radius inch	Back radius inch
SR 32 (RÜ200/R120)	032000008060	4.72	7.87
SR 32 (RÜ200/R135)	032000010060	5.31	7.87
SR 32 (RÜ200/R150)	032000012060	5.91	7.87
SR 32 (RÜ200/R170)	032000015060	6.69	7.87
SR 32 (RÜ200/R200)	032000020060	7.87	7.87
SR 32 (RÜ200/R250)	032000025060	9.84	7.87

GUIDE CHANNEL VAW (ALUMINUM / STAINLESS STEEL)



VAW steel galvanized / stainless steel



VAW aluminum

A range of variable guide channel systems, constructed from aluminum or stainless steel sections, is available for this cable drag chain.

The variable guide channel ensures that the cable drag chain is supported and guided securely.

ASSEMBLY INSTRUCTION FLEXIBLE CHAIN BRACKET FB/FG

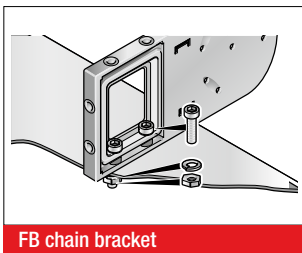

FB chain bracket

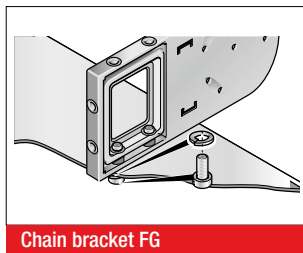

Chain bracket FG

Brass bushes guarantee long-lasting fastening without cold flow in the plastic.

Version KA-FB:

Integrated through-hole fastened down using nut and bolt.

Version KA-FG:

Built-in threads allow for quick and easy on-site mounting, since a screw, including a retaining washer where necessary, is sufficient.

ASSEMBLY

DISASSEMBLY

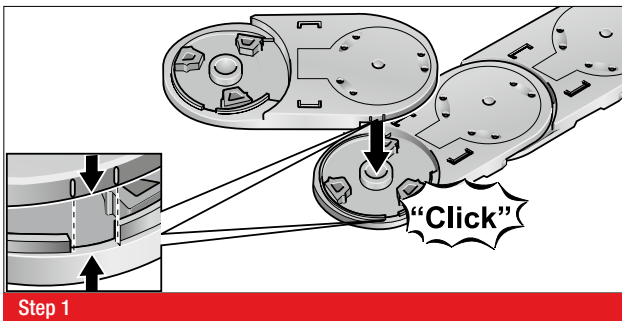

Step 1

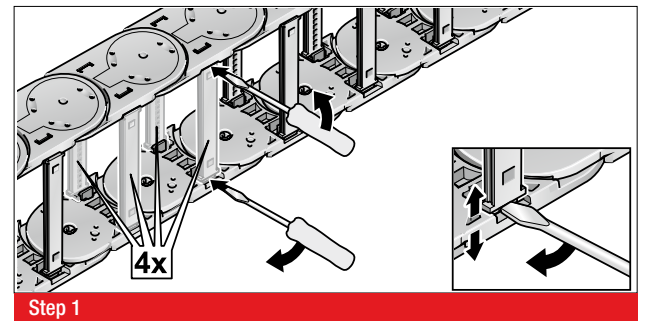

Step 1

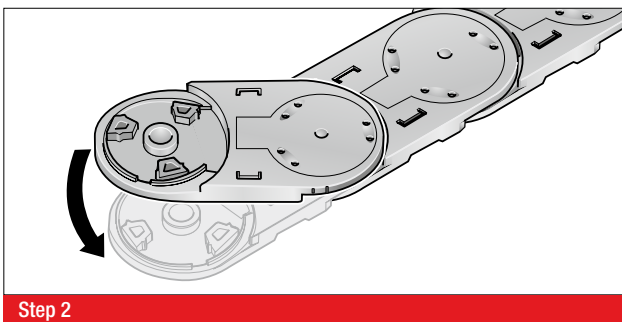

Step 2

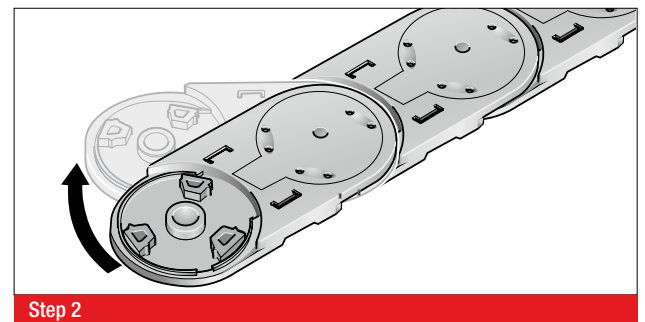

Step 2

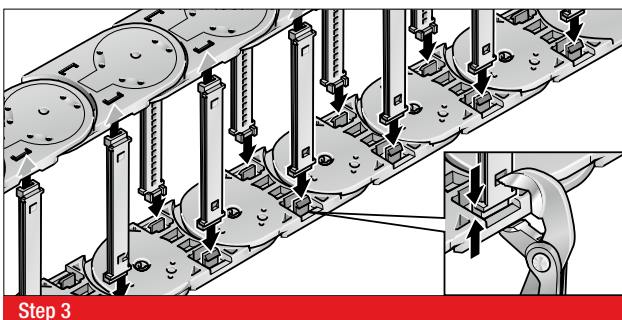

Step 3

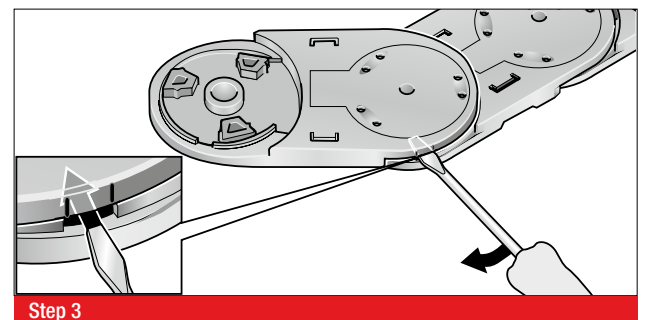

Step 3

MP 35 OPEN



- METAL CHAIN BRACKET
- LOW-COST VARIANT

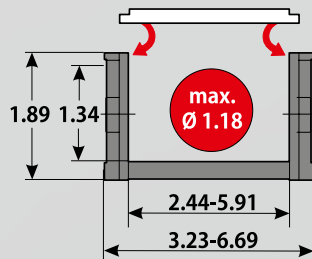

TECHNICAL DATA

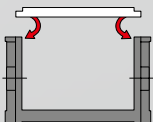

Loading side
Inside bend

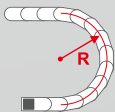

Available radii
2.76 – 11.81 inch

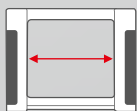

Available interior widths
With plastic crossbar
2.44 – 5.91 inch

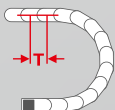

Grid
T = 2.28 inch

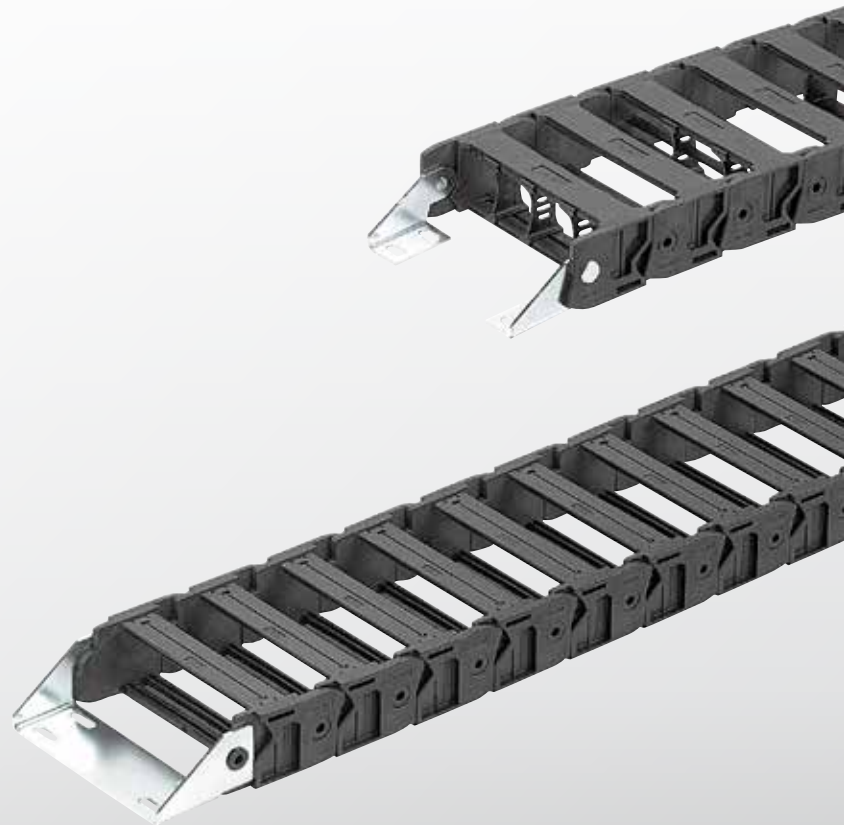

TECHNICAL SPECIFICATIONS

Travel distance gliding L_g max.	262.47 ft.
Travel distance self-supporting L_s max.	see diagram on page 347
Travel distance vertical, hanging L_{vh} max.	131.23 ft.
Travel distance vertical, upright L_{vs} max.	9.84 ft.
Rotated 90°, unsupported L_{90f} max.	3.28 ft.
Speed, gliding V_g max.	9.84 ft/s
Speed, self-supporting V_s max.	32.81 ft/s
Acceleration, gliding a_g max.	49.21 ft/s ²
Acceleration, self-supporting a_s max.	65.62 ft/s ²

Contact our engineering department to meet any higher requirements: efk@murrplastik.de



MATERIAL PROPERTIES

Standard material	Polyamide (PA) black
Service temperature	-22.00 – 248.00 °F
Gliding friction factor	0.30
Static friction factor	0.45
Fire classification	Based on UL 94 HB

Other material properties on request

SHELVING SYSTEM

CHAIN BRACKET

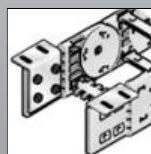

Chain bracket angle

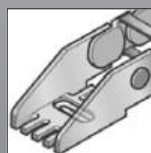

Chain bracket U-part

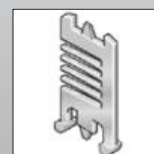

Separator TR



RS shelving system

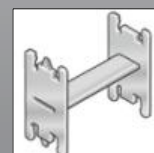

H-shaped shelf unit RE

GUIDE CHANNELS



VAW steel galvanized / stainless steel



VAW aluminum

ORDERING KEY

Type code	Variation	Inside width	Outside width	Inside width	Outside width	Radius	Rail variant	Material	Chain length
0350 02	Crossbar on outside bend Crossbar on inside bend Opens on inside of bend	062 [2.44]	082 [3.23]			070 [2.76]	0 Plastic, full-ridged with bias	0 Polyamide (PA): standard (PA/black)	
		086 [3.39]	106 [4.17]						
		102 [4.02]	122 [4.80]			100 [3.94]	1 Plastic, full-ridged without bias	9 Special version (on request)	
		125 [4.92]	145 [5.71]						
		150 [5.91]	170 [6.69]			150 [5.91]			
						200 [7.87]			
						300 [11.81]			

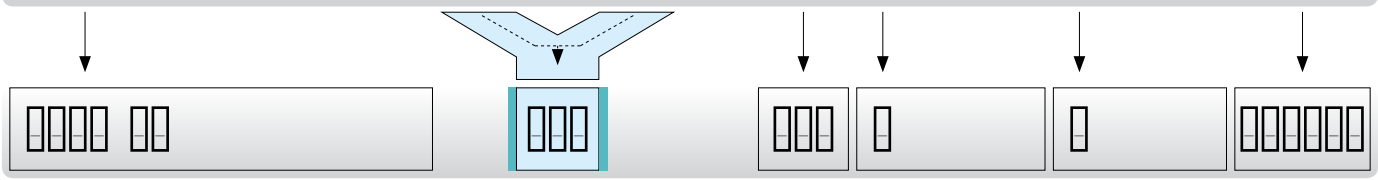

ORDERING EXAMPLE: 0350 062 070 0 0 000050

Crossbar on outside bend, crossbar on inside bend, can be opened from inside bend
 Inside width 2.44 in.; radius 2.76 in.
 Plastic crossbar, full-ridged with bias, material black-colored polyamide
 Chain length 50 in. (22 links)

SELF-SUPPORTING LENGTH

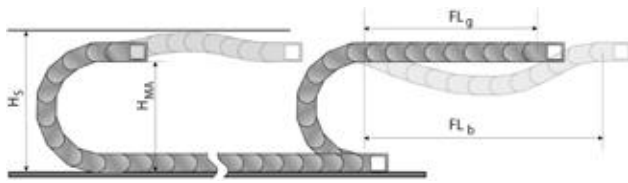

The self-supporting length is the distance between the chain bracket on the moving end and the start of the chain arch.
 The installation variant FL_g offers the lowest load and wear for the cable drag chain.
 The maximum travel parameters (speed and acceleration) can be applied for this variant.

- H_s = Installation height plus safety
- H_{MA} = Height of moving end connection
- FL_g = Self-supporting length, upper run straight
- FL_b = Self-supporting length, upper run bent

LOAD DIAGRAM FOR SELF-SUPPORTING APPLICATIONS

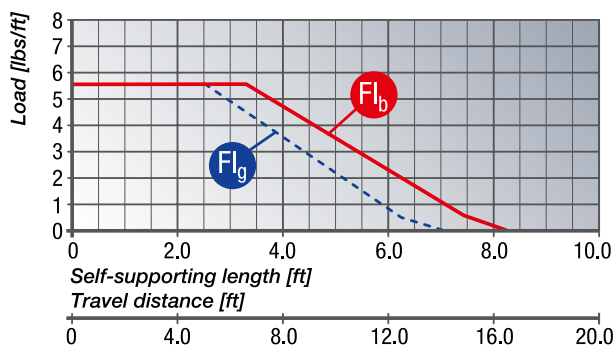

FL_g Self-supporting length, upper run straight
 In the FL_g range, the chain upper run still has a bias, is straight or has a maximum sag of 2.36 inch.

FL_b Self-supporting length, upper run bent
 In the FL_b range, the chain upper run has a sag of more than 2.36 inch, but this is still less than the maximum sag. Where the sag is greater than that permitted in the FL_b range, the application is critical and should be avoided. The self-supporting length can be optimized by using a support for the upper run or a more stable cable drag chain.

DETERMINING THE CHAIN LENGTH

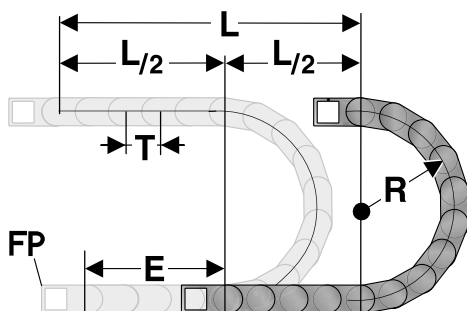

The fixed point of the cable drag chain should be connected in the middle of the travel distance.
 This arrangement gives the shortest connection between the fixed point and the moving bracket and thus the most efficient chain length.

Chain length calculation = $L/2 + \pi * R + 2 * T + E$
 $\approx 1 \text{ ft chain} = 17 \text{ qty.} \times 2.28 \text{ inch.}$

- E = Distance between entry point and middle of travel distance
- L = Travel distance
- R = Radius
- P = Grid 2.28 inch

INSTALLATION DIMENSIONS

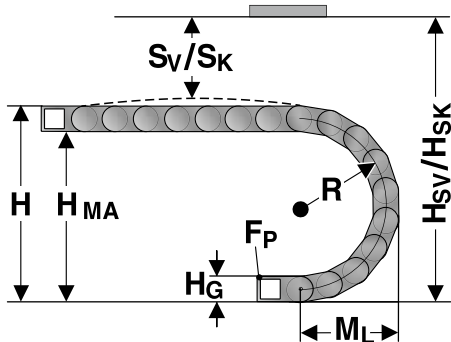

The moving end chain connection is to be screw fixed at height H_{MA} for the respective radius.

Concerning the installed dimensions, you must take into account whether the chain links are equipped with or without bias. For chain links without bias, the “Installed height without bias H_{SK} ” value has to be taken into account.

If the chain links are equipped with a bias, the value “Installed height with bias H_{SV} ” has to be taken into account.

Radius R	2.76	3.94	5.91	7.87	11.81
Outside height of chain link (H_G)	1.89	1.89	1.89	1.89	1.89
Height of bend (H)	7.41	9.77	13.71	17.63	25.51
Height of moving end connection (H_{MA})	5.52	7.88	11.82	15.74	23.62
Safety margin with bias (S_V)	1.57	1.57	1.57	1.57	1.57
Installation height with bias (H_{SV})	8.98	11.34	15.28	19.20	27.08
Safety margin without bias (S_K)	0.59	0.59	0.59	0.59	0.59
Installation height without bias (H_{SK})	8.00	10.36	14.30	18.22	26.10
Arc projection (M_L)	5.99	7.16	9.14	11.10	15.04

KA 35 CHAIN BRACKET ANGLE

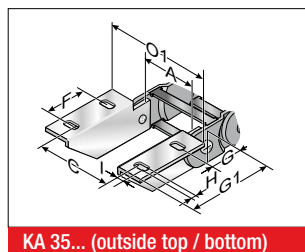
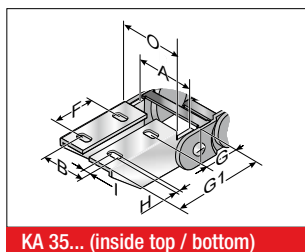

The chain bracket can be supplied either in galvanized sheet steel or stainless steel. To secure one cable drag chain, you will need two angle brackets (left and right) with a drilled hole and two angle brackets (left and right) with a bolt. The Order No.s given below each comprise a left and right angle bracket.

Type	Order No.	Material	Inside width							Outside width of KA 0	Outside width of KA 01
			A inch	B inch	C inch	F inch	G inch	HØ inch	I inch		
KA 3508 Female end	0350000054	Sheet steel	2.44 – 5.91	A-0.28	A+1.10	0.98	0.79	0.28	0.31	A+0.79	A+2.05
KA 3508 Male end	0350000055	Sheet steel	2.44 – 5.91	A-0.47	A+1.52	0.98	0.79	0.28	0.31	A+0.39	A+2.05
KA 3509 Female end	0350000056	Stainless steel 1.4301	2.44 – 5.91	A-0.28	A+1.10	0.98	0.79	0.28	0.31	A+0.79	A+2.05
KA 3509 Male end	0350000057	Stainless steel 1.4301	2.44 – 5.91	A-0.47	A+1.52	0.98	0.79	0.28	0.31	A+0.39	A+2.05

KA 35 CHAIN BRACKET U-PART

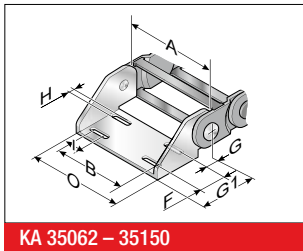

The metal connection (U-section) is precisely adjusted to the respective chain width. It only needs to be snapped in the chain link. Please order one male and one female end bracket for each chain. The brackets should be fastened with M6 screws.

KA 35062 – 35150

Type	Order No.	Material	Inside width							Outside width of KA O inch
			A inch	B inch	F inch	G inch	G1 inch	HØ inch	I inch	
KA 35062 Female end	035000007000	Sheet steel	2.44	A-0.28	0.98	0.79	2.17	0.28	0.59	A+0.79
KA 35062 Male end	035000007100	Sheet steel	2.44	A-0.47	0.98	0.79	2.17	0.28	0.59	A+0.79
KA 35086 Female end	035000007200	Sheet steel	3.39	A-0.28	0.98	0.79	2.17	0.28	0.59	A+0.79
KA 35086 Male end	035000007300	Sheet steel	3.39	A-0.47	0.98	0.79	2.17	0.28	0.59	A+0.79
KA 35102 Female end	035000007400	Sheet steel	4.02	A-0.28	0.98	0.79	2.17	0.28	0.59	A+0.79
KA 35102 Male end	035000007500	Sheet steel	4.02	A-0.47	0.98	0.79	2.17	0.28	0.59	A+0.79
KA 35125 Female end	035000007600	Sheet steel	4.92	A-0.28	0.98	0.79	2.17	0.28	0.59	A+0.79
KA 35125 Male end	035000007700	Sheet steel	4.92	A-0.47	0.98	0.79	2.17	0.28	0.59	A+0.79
KA 35150 Female end	035000007800	Sheet steel	5.91	A-0.28	0.98	0.79	2.17	0.28	0.59	A+0.79
KA 35150 Male end	035000007900	Sheet steel	5.91	A-0.47	0.98	0.79	2.17	0.28	0.59	A+0.79
KA 35062 Female end	035000008000	Stainless steel 1.4301	2.44	A-0.28	0.98	0.79	2.17	0.28	0.59	A+0.79
KA 35062 Male end	035000008100	Stainless steel 1.4301	2.44	A-0.47	0.98	0.79	2.17	0.28	0.59	A+0.79
KA 35086 Female end	035000008200	Stainless steel 1.4301	3.39	A-0.28	0.98	0.79	2.17	0.28	0.59	A+0.79
KA 35086 Male end	035000008300	Stainless steel 1.4301	3.39	A-0.47	0.98	0.79	2.17	0.28	0.59	A+0.79
KA 35102 Female end	035000008400	Stainless steel 1.4301	4.02	A-0.28	0.98	0.79	2.17	0.28	0.59	A+0.79
KA 35102 Male end	035000008500	Stainless steel 1.4301	4.02	A-0.47	0.98	0.79	2.17	0.28	0.59	A+0.79
KA 35125 Female end	035000008600	Stainless steel 1.4301	4.92	A-0.28	0.98	0.79	2.17	0.28	0.59	A+0.79
KA 35125 Male end	035000008700	Stainless steel 1.4301	4.92	A-0.47	0.98	0.79	2.17	0.28	0.59	A+0.79
KA 35150 Female end	035000008800	Stainless steel 1.4301	5.91	A-0.28	0.98	0.79	2.17	0.28	0.59	A+0.79
KA 35150 Male end	035000008900	Stainless steel 1.4301	5.91	A-0.47	0.98	0.79	2.17	0.28	0.59	A+0.79

TR 35 SEPARATOR

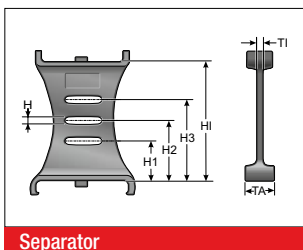

Separator

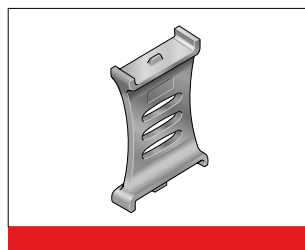

We recommend that separators be used if multiple round cables or conduits with differing diameters are to be installed.

Type	Order No.	Description	Version	TI inch	TA inch	H inch	H1 inch	H2 inch	H3 inch	H4 inch
TR 35	035000009200	Separator	lockable	0.08	0.51	0.10	0.43	0.67	0.90	1.33

MP 35 SHELVING SYSTEM

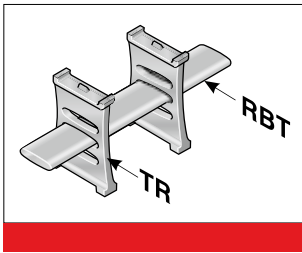

The shelf must be used with a minimum of two separators to create a shelving system. The additional levels prevent cables from criss-crossing and minimize the friction between them. The shelves are matched to the available chain widths.

Type	Order No.	Description	Width inch	Lock grid spacing inch
RBT 062	100000006200	Shelf	2.44	0.12
RBT 086	100000008600	Shelf	3.39	0.12
RBT 101	100000010100	Shelf	3.98	0.12
RBT 125	100000012500	Shelf	4.92	0.12
RBT 150	100000015000	Shelf	5.91	0.12

RE 35 H-SHAPED SHELF UNIT

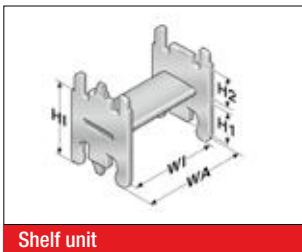

One-piece shelving system, the shelf cannot be varied in height.

Shelf unit

Type	Order No.	Description	WA inch	WI inch	H1 inch	H2 inch	HI inch
RE 35/33	100000353310	H-shaped shelf unit	1.40	1.20	0.71	0.47	1.30
RE 35/48	100000354810	H-shaped shelf unit	1.99	1.79	0.71	0.47	1.30
RE 35/57	100000355710	H-shaped shelf unit	2.34	2.15	0.71	0.47	1.30

GUIDE CHANNEL VAW (ALUMINUM / STAINLESS STEEL)



VAW steel galvanized / stainless steel



VAW aluminum

A range of variable guide channel systems, constructed from aluminum or stainless steel sections, is available for this cable drag chain. The variable guide channel ensures that the cable drag chain is supported and guided securely.

ASSEMBLY

DISASSEMBLY

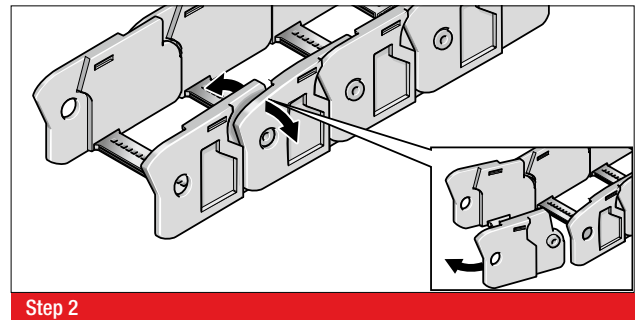
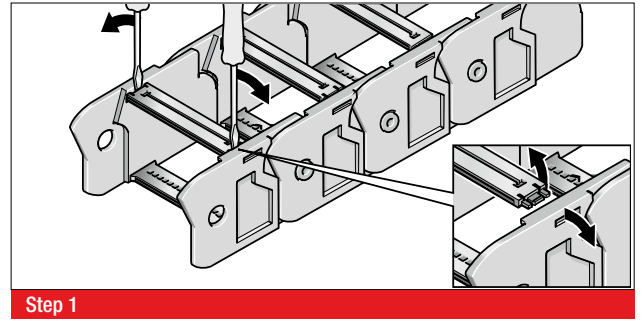
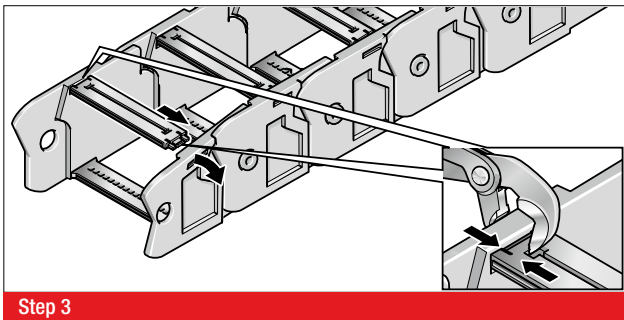
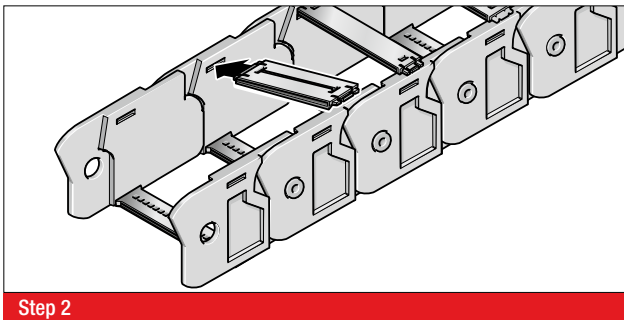
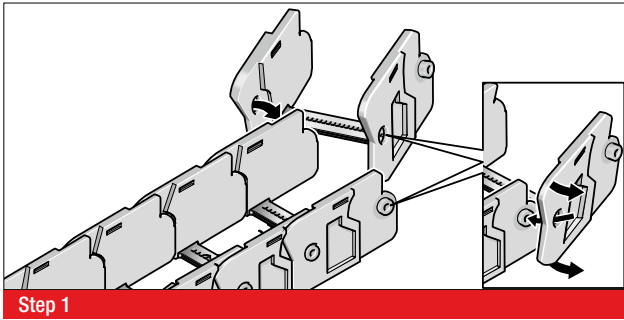

MP 41 OPEN



- PLASTIC OR ALUMINUM VERSION
- CHAIN BRACKET FLEXIBLE

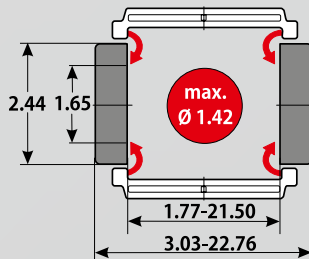

TECHNICAL DATA

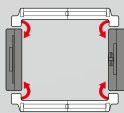

Loading side
Inside and outside bend

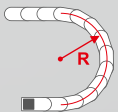

Available radii
3.54 – 13.78 inch

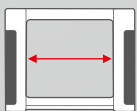

Available interior widths
With plastic crossbar
1.77 – 21.5 inch
With aluminum crossbar / cover
2.64 – 23.62 inch /

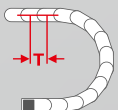

Grid
T = 3.03 inch

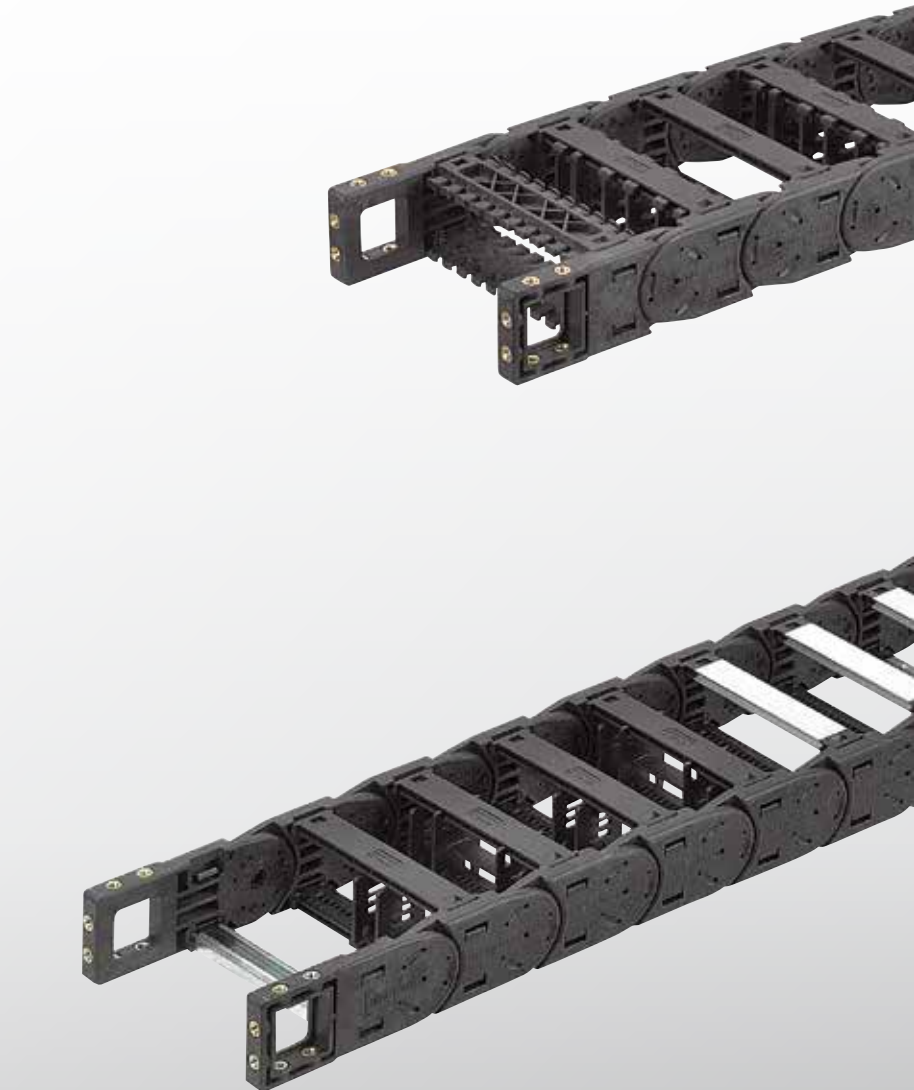



TECHNICAL SPECIFICATIONS

Travel distance gliding L_g max.	393.70 ft.
Travel distance self-supporting L_s max.	see diagram on page 355
Travel distance vertical, hanging L_{vh} max.	164.04 ft.
Travel distance vertical, upright L_{vs} max.	19.69 ft.
Rotated 90°, unsupported L_{90f} max.	6.56 ft.
Speed, gliding V_g max.	16.40 ft/s
Speed, self-supporting V_f max.	65.62 ft/s
Acceleration, gliding a_g max.	82.02 ft/s ²
Acceleration, self-supporting a_f max.	98.43 ft/s ²

Contact our engineering department to meet any higher requirements: efk@murrplastik.de

MATERIAL PROPERTIES

Standard material	Polyamide (PA) black
Service temperature	-22.00 – 248.00 °F
Gliding friction factor	0.30
Static friction factor	0.45
Fire classification	UL 94 HB

Other material properties on request

SHELVING SYSTEM



Separator TR

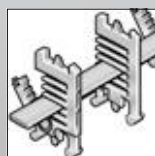

RS shelving system

CHAIN BRACKET

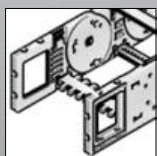

Chain bracket flexible

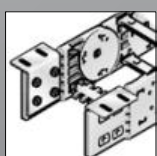

Chain bracket angle



Crossbar connector RSV

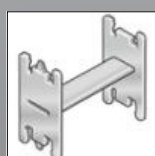

H-shaped shelf unit RE

ACCESSORIES



Bracket bar

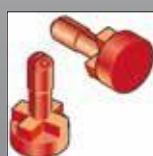

Lock button

GUIDE CHANNELS



VAW steel galvanized / stainless steel

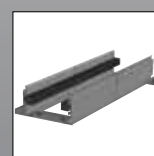

VAW aluminum

STRAIN RELIEF



RS-ZL crossbar strain relief



STF Steel Fix

ORDERING KEY

Type code	Variation	Inside width	Outside width	Inside width	Outside width	Radius	Rail variant	Material	Chain length
0410 30	Crossbar on outside bend Crossbar on inside bend Opens on inside and outside of bend	045 [1.77]	077 [3.03]	233 [9.17]	265 [10.43]	090 [3.54]	0 Plastic, full-ridged with bias	0 Polyamide (PA): standard (PA/black)	
		057 [2.24]	089 [3.50]	246 [9.69]	278 [10.94]				
		062 [2.44]	094 [3.70]	252 [9.92]	284 [11.18]	120 [4.72]	2 Plastic, half-ridged with bias	9 Special version (on request)	
		071 [2.80]	103 [4.06]	258 [10.16]	290 [11.42]				
		084 [3.31]	116 [4.57]	296 [11.65]	328 [12.91]	150 [5.91]	4 Aluminum full-ridged with bias		
		093 [3.66]	125 [4.92]	346 [13.62]	378 [14.88]				
		096 [3.78]	128 [5.04]	350 [13.78]	382 [15.04]	200 [7.87]	6 Aluminum half-ridged with bias		
		104 [4.09]	136 [5.35]	358 [14.09]	390 [15.35]				
		107 [4.21]	139 [5.47]	371 [14.61]	403 [15.87]	250 [9.84]	9 Special version (on request)		
		121 [4.76]	153 [6.02]	396 [15.59]	428 [16.85]				
		133 [5.24]	165 [6.50]	421 [16.57]	453 [17.83]	300 [11.81]			
		144 [5.67]	176 [6.93]	446 [17.56]	478 [18.82]				
		146 [5.75]	178 [7.01]	496 [19.53]	528 [20.79]	350 [13.78]			
		158 [6.22]	190 [7.48]	546 [21.50]	578 [22.76]				
		164 [6.46]	196 [7.72]						
		171 [6.73]	203 [7.99]						
		182 [7.17]	214 [8.43]						
		196 [7.72]	228 [8.98]						
		208 [8.19]	240 [9.45]						
		220 [8.66]	252 [9.92]						

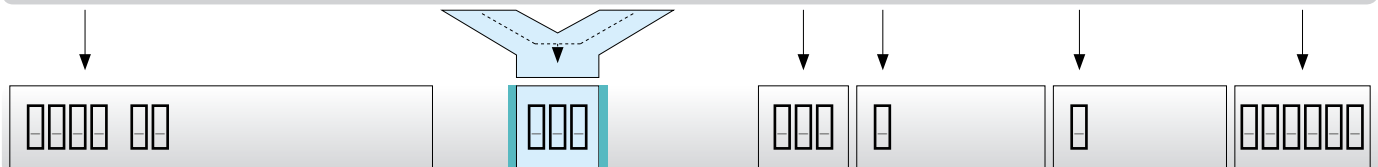

ORDERING EXAMPLE: 0410 045 090 0 0 000054

Crossbar on outside bend, crossbar on inside bend, can be opened from inside and outside bend
 Inside width 1.77 in.; radius 3.54 in.
 Plastic crossbar, full-ridged with bias, material black-colored polyamide
 Chain length 54 in. (18 links)

NOTE ON CONFIGURATION

Aluminum crossbars:

Aluminum crossbars in 0.04 in (1 mm) width sizes for inner widths from 2.64 inch – 23.62 inch are available for delivery.

Crossbar connector and crossbar strain relief plate:

Once inside widths exceed 9.69 inches (246 mm), we recommend the deployment of crossbar connectors (RSV). If crossbar strain relief plates (RS-ZL) are to be deployed in the chain brackets, take standard inside widths into account.

For detailed information, please consult the corresponding product documentation.

SELF-SUPPORTING LENGTH

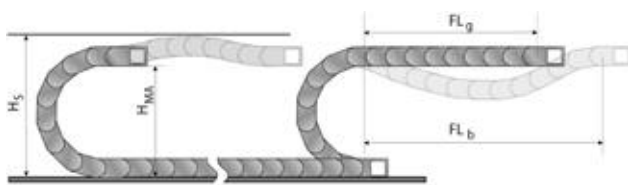

The self-supporting length is the distance between the chain bracket on the moving end and the start of the chain arch. The installation variant FL_g offers the lowest load and wear for the cable drag chain. The maximum travel parameters (speed and acceleration) can be applied for this variant.

- H_S = Installation height plus safety
- H_{MA} = Height of moving end connection
- FL_g = Self-supporting length, upper run straight
- FL_b = Self-supporting length, upper run bent

LOAD DIAGRAM FOR SELF-SUPPORTING APPLICATIONS

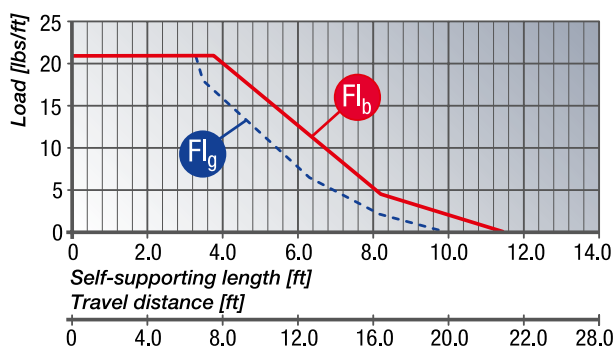

FL_g Self-supporting length, upper run straight

In the FL_g range, the chain upper run still has a bias, is straight or has a maximum sag of 2.76 inch.

FL_b Self-supporting length, upper run bent

In the FL_b range, the chain upper run has a sag of more than 2.76 inch, but this is still less than the maximum sag. Where the sag is greater than that permitted in the FL_b range, the application is critical and should be avoided. The self-supporting length can be optimized by using a support for the upper run or a more stable cable drag chain.

DETERMINING THE CHAIN LENGTH

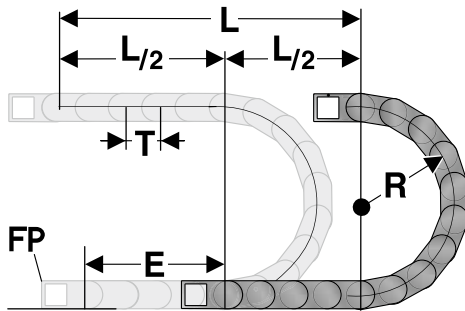

The fixed point of the cable drag chain should be connected in the middle of the travel distance. This arrangement gives the shortest connection between the fixed point (FP) and the moving bracket and thus the most efficient chain length.

Chain length calculation = $L/2 + \pi * R + E$
 $\approx 1 \text{ ft chain} = 4 \text{ qty.} \times 3.03 \text{ inch.}$

- E = Distance between entry point and middle of travel distance
- L = Travel distance
- R = Radius
- P = Grid 3.03 inch

INSTALLATION DIMENSIONS

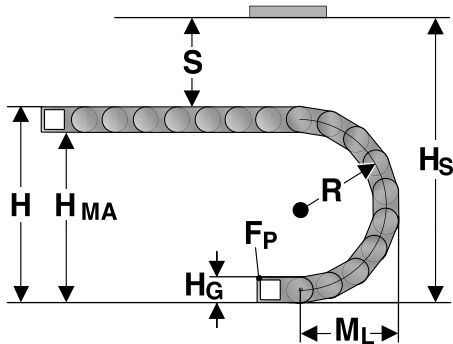

The moving end chain connection is to be screw fixed at height H_{MA} for the respective radius. For the installed dimension the "Installed height H_s " value has to be taken into account.

Radius R	3.54	4.72	5.91	7.87	9.84	11.81	13.78
Outside height of chain link (H_o)	2.44	2.44	2.44	2.44	2.44	2.44	2.44
Height of bend (H)	9.92	12.28	14.66	18.58	22.52	26.46	30.40
Height of moving end connection (H_{MA})	7.48	9.84	12.22	16.14	20.08	24.02	27.96
Safety margin (S)	1.18	1.18	1.18	1.18	1.18	1.18	1.18
Installation height (H_s)	11.10	13.46	15.84	19.76	23.70	27.64	31.58
Arc projection (M_L)	7.99	9.17	10.36	12.32	14.29	16.26	18.23

POWERLINE PLASTIC CROSSBAR



The crossbars connect the two side runs of the cable drag chain. The crossbar length is synonymous with the inside width of the cable drag chain.

Type	Order No.	Description	Inside width inch
BS 045-5	052004500000	Crossbar	1.77
BS 057-5	052005700000	Crossbar	2.24
BS 062-5	052006200000	Crossbar	2.44
BS 071-5	052007100000	Crossbar	2.80
BS 084-5	052008400000	Crossbar	3.31
BS 093-5	052009300000	Crossbar	3.66
BS 096-5	052009600000	Crossbar	3.78
BS 104-5	052010400000	Crossbar	4.09
BS 107-5	052010700000	Crossbar	4.21
BS 121-5	052012100000	Crossbar	4.76
BS 133-5	052013300000	Crossbar	5.24
BS 144-5	052014400000	Crossbar	5.67
BS 146-5	052014600000	Crossbar	5.75
BS 158-5	052015800000	Crossbar	6.22
BS 164-5	052016400000	Crossbar	6.46
BS 171-5	052017100000	Crossbar	6.73
BS 182-5	052018200000	Crossbar	7.17
BS 196-5	052019600000	Crossbar	7.72
BS 208-5	052020800000	Crossbar	8.19
BS 220-5	052022000000	Crossbar	8.66
BS 233-5	052023300000	Crossbar	9.17
BS 246-5	052024600000	Crossbar	9.69
BS 252-5	052025200010	Crossbar	9.92
BS 258-5	052025800000	Crossbar	10.16
BS 296-5	052029600000	Crossbar	11.65
BS 346-5	052034600000	Crossbar	13.62
BS 350-5	052035000000	Crossbar	13.78
BS 358-5	052035800000	Crossbar	14.09
BS 371-5	052037100000	Crossbar	14.61
BS 396-5	052039600000	Crossbar	15.59
BS 421-5	052042100000	Crossbar	16.57
BS 446-5	052044600000	Crossbar	17.56
BS 496-5	052049600000	Crossbar	19.53
BS 546-5	052054600000	Crossbar	21.50

KA 41 CHAIN BRACKET FLEXIBLE

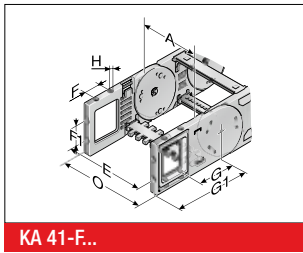

KA 41-F..

This chain bracket offers universal connection options (top, bottom and front) and is attached to the ends of the chain like a side link. This allows the chain to move right up to the bracket. Each chain requires one male and one female bracket. M6 screws are used to secure the brackets in place. Extrusion-coated metal bushes with either a through-hole (-FB) or a threaded hole (-FG) ensure the permanent, high-strength transmission of even extreme forces onto the cable drag chain.

Type	Order No.	Material	Version	Inside width								Outside width of KA 0 inch
				A inch	E inch	F inch	F1 inch	G inch	G1 inch	H inch	H0 inch	
KA 41.1-FB	0411000054	Plastic	with bush	1.77 – 21.50	A+0.79	0.89	0.87	3.11	4.72		0.26	A+1.34
KA 41.1-FG	0411000055	Plastic	with thread	1.77 – 21.50	A+0.79	0.89	0.87	3.11	4.72	M6		A+1.34

KA 41 CHAIN BRACKET ANGLE

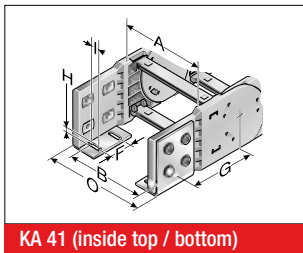

KA 41 (inside top / bottom)

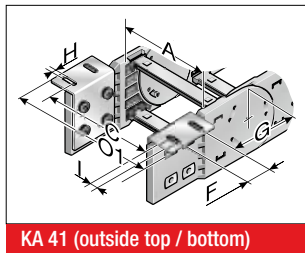

KA 41 (outside top / bottom)

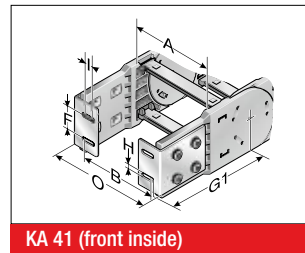

KA 41 (front inside)

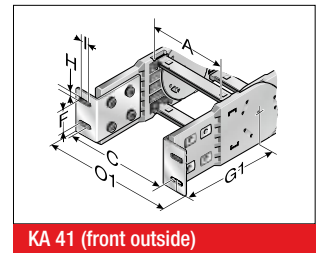

KA 41 (front outside)

There are several options regarding the chain bracket. The fixed-point bracket (inside/bottom) and the moving end bracket (inside/top) are supplied as standard. However, any other combination can be supplied upon request. The chain bracket is fas-

tened at the end like a side link. This enables the chain to move right up to the bracket. Each chain requires two chain brackets. The brackets should be fastened with M6 screws.

Type	Order No.	Material	Inside width							Outside width of KA 0 inch	Outside width of KA 01 inch
			A inch	B inch	C inch	F inch	G inch	G1 inch	H0 inch		
KA 41	0410000051	Sheet steel	1.77 – 21.50	A-0.10	A+1.36	1.26	3.11	4.95	0.26	A+1.26	A+2.80

TR 41 SEPARATOR

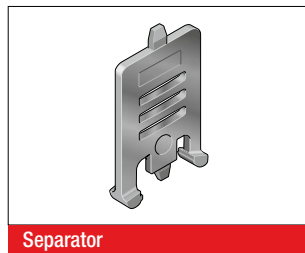
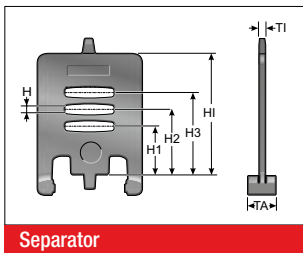

We recommend that separators be used if multiple round cables or conduits with differing diameters are to be installed.

Type	Order No.	Description	Version	TI inch	TA inch	H inch	H1 inch	H2 inch	H3 inch	HI inch
TR 41	041000009200	Separator	lockable	0.14	0.39	0.17	0.63	0.90	1.14	1.65

TR 41.1 SEPARATOR

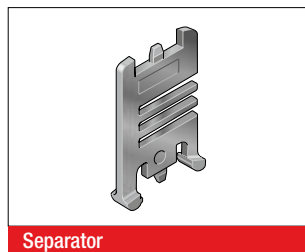
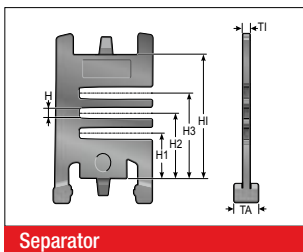

We recommend that separators be used if multiple round cables or conduits with differing diameters are to be installed.

Type	Order No.	Description	Version	TI inch	TA inch	H inch	H1 inch	H2 inch	H3 inch	HI inch
TR 41.1	041200009200	Separator	lockable	0.14	0.31	0.16	0.63	0.90	1.14	1.65

TR 41-V SEPARATOR

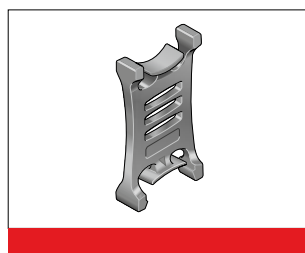
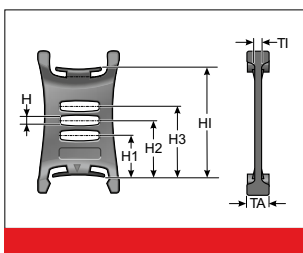

We recommend that separators be used if multiple round cables or conduits with differing diameters are to be installed.

Type	Order No.	Description	Version	TI inch	TA inch	H inch	H1 inch	H2 inch	H3 inch	HI inch
TR 41-V	041000009300	Separator	movable	0.14	0.47	0.16	0.63	0.90	1.14	1.65

RTT 41 SHELF SUPPORT, DIVISIBLE

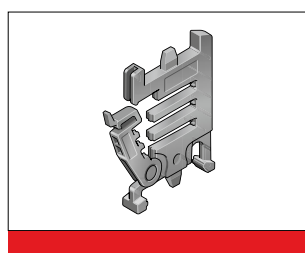
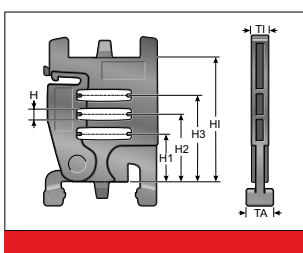

In connection with two separable shelf supports (RTT) with at least one end-to-end shelf (RB) the shelf becomes an easy to fill shelving system. The additional levels prevent cables from criss-crossing and minimize the friction between them.

Type	Order No.	Description	Version	TI inch	TA inch	H inch	H1 inch	H2 inch	H3 inch	HI inch
RTT 41	100090412000	Shelf support, divisible	lockable	0.28	0.31	0.16	0.63	0.90	1.14	1.65

RB-5 SHELF

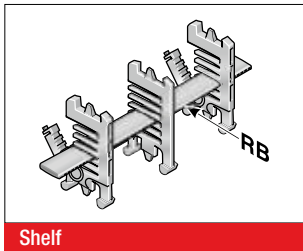

In connection with at least two separable shelf supports (RTT), the shelf becomes a shelving system. The additional levels prevent cables from criss-crossing and minimize the friction between them.

Type	Order No.	Description	Width inch	Inside width inch
RB 028-5	10000002800	Shelf	1.10	1.77
RB 034-5	1000003405	Shelf	1.32	1.77
RB 039-5	1000003905	Shelf	1.54	1.77
RB 045-5	1000004505	Shelf	1.76	2.24
RB 050-5	1000005005	Shelf	1.98	2.24
RB 056-5	10000005601	Shelf	2.20	2.44
RB 062-5	1000006205	Shelf	2.43	2.44
RB 067-5	1000006705	Shelf	2.65	3.31
RB 073-5	1000007305	Shelf	2.87	3.31
RB 078-5	1000007805	Shelf	3.09	3.31
RB 084-5	10000008400	Shelf	3.31	3.31
RB 090-5	1000009005	Shelf	3.53	3.78
RB 095-5	1000009505	Shelf	3.75	3.78
RB 101-5	1000010105	Shelf	3.97	4.21
RB 106-5	1000010605	Shelf	4.19	4.21
RB 112-5	100000011200	Shelf	4.41	4.76
RB 118-5	1000011805	Shelf	4.63	4.76
RB 123-5	1000012305	Shelf	4.85	5.24
RB 129-5	1000012905	Shelf	5.07	5.24
RB 134-5	1000013405	Shelf	5.29	5.67
RB 140-5	100000014000	Shelf	5.51	5.67
RB 146-5	1000014605	Shelf	5.73	6.22
RB 151-5	1000015105	Shelf	5.95	6.22
RB 157-5	1000015705	Shelf	6.17	6.46
RB 162-5	1000016205	Shelf	6.39	6.46
RB 168-5	100000016800	Shelf	6.61	7.17
RB 174-5	1000017405	Shelf	6.83	7.17
RB 179-5	1000017905	Shelf	7.06	7.72
RB 185-5	1000018505	Shelf	7.28	7.72
RB 190-5	1000019005	Shelf	7.50	7.72
RB 196-5	100000019600	Shelf	7.72	7.72
RB 291-5	100000029100	Shelf	11.46	13.62

RSV 41 CROSSBAR CONNECTOR

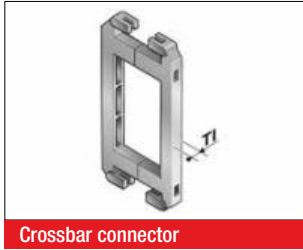

For crossbars wider than 9.69 inch (246 mm), we recommend the use of crossbar connectors. These prevent deformation to the crossbar under large amounts of additional weight of the chain assembly.

Type	Order No.	Description	TI inch
RSV 41	041000009600	Crossbar connector	0.30
RSV 41 Alu	041000009800	Crossbar connector for aluminum crossbars	0.30

RE 41 H-SHAPED SHELF UNIT

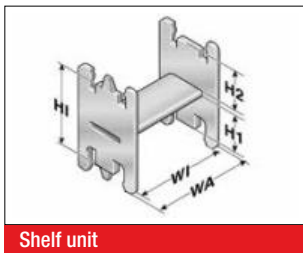

One-piece shelving system, the shelf cannot be varied in height.

Type	Order No.	Description	WA inch	WI inch	H1 inch	H2 inch	HI inch
RE 36/11	100000361112	H-shaped shelf unit	1.67	1.44	1.03	0.45	1.65
RE 59/18	100000591812	H-shaped shelf unit	2.56	2.32	0.74	0.74	1.65
RE 81/11	100000811112	H-shaped shelf unit	3.44	3.21	1.03	0.45	1.65

BS-5 BRACKET BAR



Large-diameter conduits are routed securely by using bracket bars (BS). This bar is installed on the crossbars or the covers of the cable drag chain. The bracket bar can be installed on both the inside and outside bend.

The bracket bar support (BSH) is used to attach the bars to PowerLine series crossbars. Two bracket bar supports are required for each bar.

Type	Order No.	Description	Conduit diameter max. inch	Installation height inch	Inner chain width min. inch
BS 120-5	052412000000	Bracket bar	4.53	5.51	6.46
BS 153-5	052415300000	Bracket bar	5.83	6.69	8.19
BS 187-5	052418700000	Bracket bar	7.17	8.07	9.17
BSH-5	052400000000	Bracket bar support			
Assembly set	052400000001	Assembly set			

RS-ZL-5 CROSSBAR STRAIN RELIEF PLATE

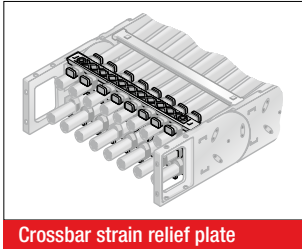

Crossbar strain relief plate

Fixed integrated crossbar strain relief plates in the chain brackets. Tailored to all crossbar widths up to 9.69 inch (246 mm). May be assembled on the inside and outside bends at both chain endings.

Type	Order No.	Description	Inside width inch
RS-ZL 045-5	052004500010	Crossbar strain relief plate	1.77
RS-ZL 057-5	052005700010	Crossbar strain relief plate	2.24
RS-ZL 062-5	052006200010	Crossbar strain relief plate	2.44
RS-ZL 071-5	052007100010	Crossbar strain relief plate	2.80
RS-ZL 084-5	052008400010	Crossbar strain relief plate	3.31
RS-ZL 093-5	052009300010	Crossbar strain relief plate	3.66
RS-ZL 096-5	052009600010	Crossbar strain relief plate	3.78
RS-ZL 104-5	052010400010	Crossbar strain relief plate	4.09
RS-ZL 107-5	052010700010	Crossbar strain relief plate	4.21
RS-ZL 121-5	052012100010	Crossbar strain relief plate	4.76
RS-ZL 133-5	052013300010	Crossbar strain relief plate	5.24
RS-ZL 144-5	052014400010	Crossbar strain relief plate	5.67
RS-ZL 146-5	052014600010	Crossbar strain relief plate	5.75
RS-ZL 158-5	052015800010	Crossbar strain relief plate	6.22
RS-ZL 164-5	052016400010	Crossbar strain relief plate	6.46
RS-ZL 171-5	052017100010	Crossbar strain relief plate	6.73
RS-ZL 182-5	052018200010	Crossbar strain relief plate	7.17
RS-ZL 196-5	052019600010	Crossbar strain relief plate	7.72
RS-ZL 208-5	052020800010	Crossbar strain relief plate	8.19
RS-ZL 220-5	052022000010	Crossbar strain relief plate	8.66
RS-ZL 233-5	052023300010	Crossbar strain relief plate	9.17
RS-ZL 246-5	052024600010	Crossbar strain relief plate	9.69

STRAIN RELIEF WITH STEEL FIX

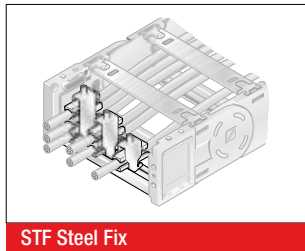
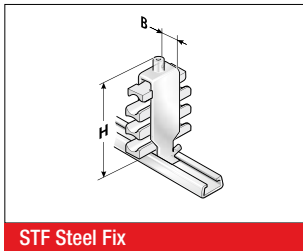

C-rails (galvanized) for permanent integration, for accommodating the Steel Fix bow clamps in the chain brackets. The bow clamps can take up to 3 cables and are suitable for C-rails with a groove width of 0.43 in (11 mm). Due to the design of the trough elements, a cable preserving cable guidance is ensured. May be assembled on the inside and outside bends at both chain endings. The overall height stated is a guide only. The actual height is, amongst other things, dependent on the diameter and the quality of the cable. A safety distance of 0.39 in (10 mm) at the fixed point above the strain relief must be kept during gliding applications.

Type	Order No.	Description	Seats qty.	Cable Ø inch	Width (B) inch	Total height (H) inch
Single clamp (for one cable)						
STF 12-1 Steel Fix	81661801	Hooped clamp	1	0.24 – 0.47	0.63	2.17
STF 14-1 Steel Fix	81661802	Hooped clamp	1	0.47 – 0.55	0.71	2.05
STF 16-1 Steel Fix	81661803	Hooped clamp	1	0.55 – 0.63	0.79	2.13
STF 18-1 Steel Fix	81661804	Hooped clamp	1	0.63 – 0.71	0.87	2.20
STF 20-1 Steel Fix	81661805	Hooped clamp	1	0.71 – 0.79	0.94	2.32
STF 22-1 Steel Fix	81661806	Hooped clamp	1	0.79 – 0.87	1.02	2.40
STF 26-1 Steel Fix	81661807	Hooped clamp	1	0.87 – 1.02	1.18	2.76
STF 30-1 Steel Fix	81661808	Hooped clamp	1	1.02 – 1.18	1.34	2.91
STF 34-1 Steel Fix	81661809	Hooped clamp	1	1.18 – 1.34	1.50	3.07
STF 38-1 Steel Fix	81661810	Hooped clamp	1	1.34 – 1.50	1.65	3.23
STF 42-1 Steel Fix	81661811	Hooped clamp	1	1.50 – 1.65	1.81	3.58
Double clamp (for two cables)						
STF 12-2 Steel Fix	81661821	Hooped clamp	2	0.24 – 0.47	0.63	2.87
STF 14-2 Steel Fix	81661822	Hooped clamp	2	0.47 – 0.55	0.71	2.91
STF 16-2 Steel Fix	81661823	Hooped clamp	2	0.55 – 0.63	0.79	3.23
STF 18-2 Steel Fix	81661824	Hooped clamp	2	0.63 – 0.71	0.87	3.39
STF 20-2 Steel Fix	81661825	Hooped clamp	2	0.71 – 0.79	0.94	3.58
STF 22-2 Steel Fix	81661826	Hooped clamp	2	0.79 – 0.87	1.02	3.74
STF 26-2 Steel Fix	81661827	Hooped clamp	2	0.87 – 1.02	1.18	4.25
STF 30-2 Steel Fix	81661828	Hooped clamp	2	1.02 – 1.18	1.34	4.76
STF 34-2 Steel Fix	81661829	Hooped clamp	2	1.18 – 1.34	1.50	5.08
Triple clamp (for three cables)						
STF 12-3 Steel Fix	81661841	Hooped clamp	3	0.24 – 0.47	0.63	3.86
STF 14-3 Steel Fix	81661842	Hooped clamp	3	0.47 – 0.55	0.71	3.86
STF 16-3 Steel Fix	81661843	Hooped clamp	3	0.55 – 0.63	0.79	4.13
STF 18-3 Steel Fix	81661844	Hooped clamp	3	0.63 – 0.71	0.87	4.37
STF 20-3 Steel Fix	81661845	Hooped clamp	3	0.71 – 0.79	0.94	4.65
STF 22-3 Steel Fix	81661846	Hooped clamp	3	0.79 – 0.87	1.02	5.12

MP 32/41 LOCK BUTTON

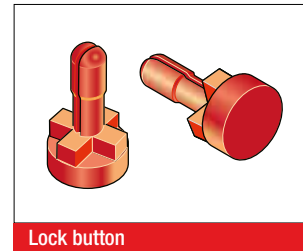
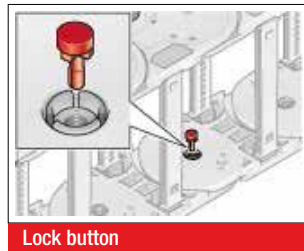
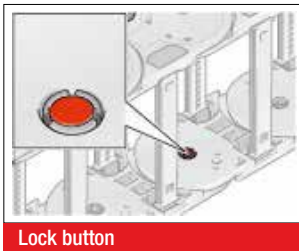

To increase the side stability we recommend the use of lock buttons during strong lateral acceleration or when installed “laying

on the side (turned 90°) without support”.

Type	Part number
MP32/41 lock button	04100008000

MP 41 LOWERED FIXING POINT

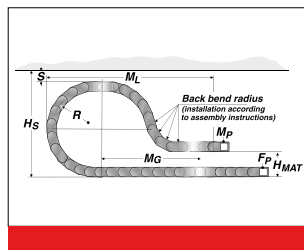
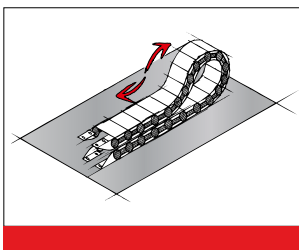

It is sometimes necessary to lower the height of the moving attachment point. In such cases, modifications to the chain layout should be noted (e.g. extension of chain). Please contact our application engineers.

Radius R inch	Height of moving end connection (H _{MA}) inch	Safety margin (S) inch	Installation height incl. safety (h _S) inch	Projection (M _L) inch	Additional links qty.	of which additional back chain links qty.
6.89	6.30	1.97	18.58	25.20	6	2
7.87	7.48	1.97	20.55	30.31	13	2
9.84	8.66	1.97	24.49	35.83	15	2
11.81	11.02	1.97	28.43	46.46	19	2
13.78	12.60	1.97	32.36	44.88	19	3

MP 41 REARWARD RADII

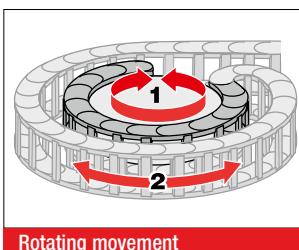

Side links with forward radius (R) and rearward radius (R_ü) allow movements in both directions. This is intended for rotating movements and lowered chain brackets. Rotation movements are only possible with open variants.

Type	Order No.	Radius inch	Back radius inch
SR 41 (R _ü 200/R125)	041000009060	4.92	7.87
SR 41 (R _ü 200/R160)	041000012060	6.30	7.87
SR 41 (R _ü 200/R175)	041000015060	6.89	7.87
SR 41 (R _ü 200/R200)	041000020060	7.87	7.87
SR 41 (R _ü 200/R250)	041000025060	9.84	7.87
SR 41 (R _ü 200/R300)	041000030060	11.81	7.87
SR 41 (R _ü 200/R350)	041000035060	13.78	7.87

GUIDE CHANNEL VAW (ALUMINUM / STAINLESS STEEL)



VAW steel galvanized / stainless steel



VAW aluminum

A range of variable guide channel systems, constructed from aluminum or stainless steel sections, is available for this cable drag chain.

The variable guide channel ensures that the cable drag chain is supported and guided securely.

ASSEMBLY INSTRUCTION FLEXIBLE CHAIN BRACKET FB/FG

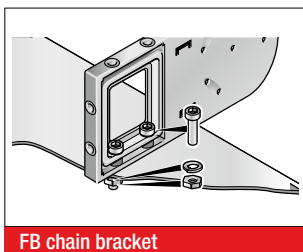

FB chain bracket

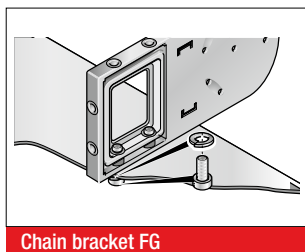

Chain bracket FG

Brass bushes guarantee long-lasting fastening without cold flow in the plastic.

Version KA-FB:

Integrated through-hole fastened down using nut and bolt.

Version KA-FG:

Built-in threads allow for quick and easy on-site mounting, since a screw, including a retaining washer where necessary, is sufficient.

ASSEMBLY

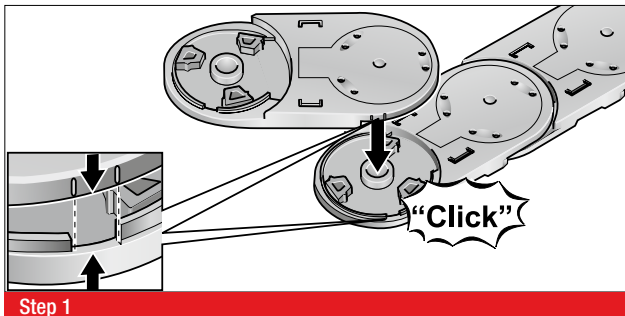

Step 1

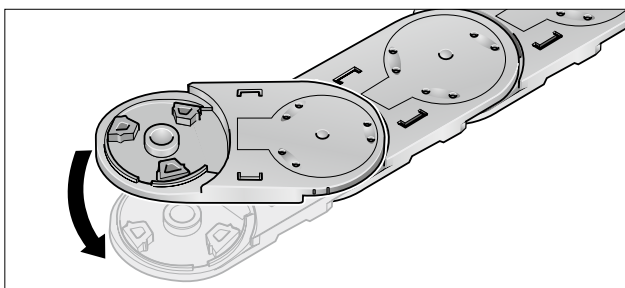

Step 2

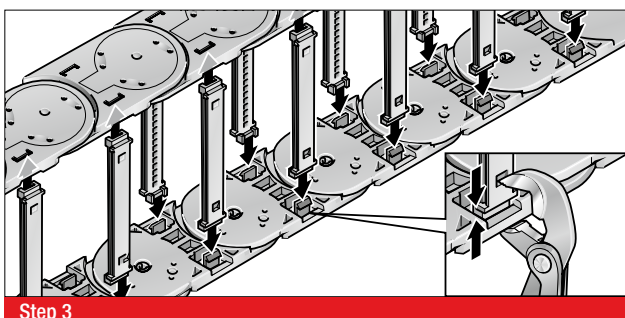

Step 3

DISASSEMBLY

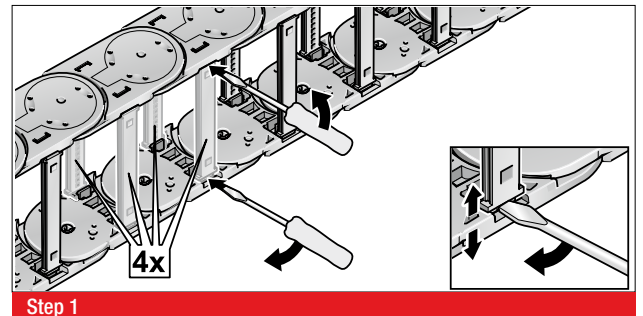

Step 1

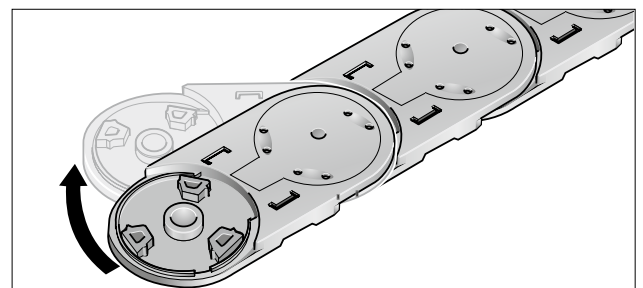

Step 2

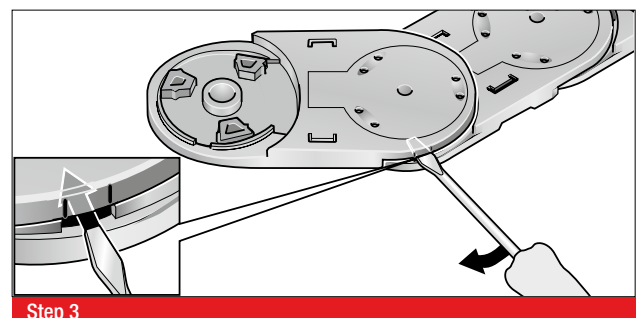

Step 3

MP 44 OPEN



- PLASTIC OR ALUMINUM VERSION
- METAL CHAIN BRACKET
- OPENS ON OUTSIDE BEND

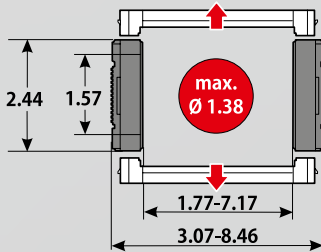

TECHNICAL DATA

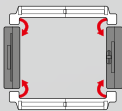

Loading side
Inside and outside bend

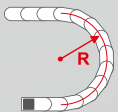

Available radii
3.54 – 15.75 inch

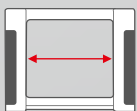

Available interior widths
With plastic crossbar
1.77 – 7.17 inch
With aluminum crossbar / cover
3.03 – 23.62 inch /

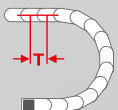

Grid
T = 2.97 inch





TECHNICAL SPECIFICATIONS

Travel distance gliding L_g max.	164.04 ft.
Travel distance self-supporting L_s max.	see diagram on page 369
Travel distance vertical, hanging L_{vh} max.	131.23 ft.
Travel distance vertical, upright L_{vs} max.	9.84 ft.
Rotated 90°, unsupported L_{90f} max.	3.28 ft.
Speed, gliding V_g max.	16.40 ft/s
Speed, self-supporting V_f max.	49.21 ft/s
Acceleration, gliding a_g max.	49.21 ft/s ²
Acceleration, self-supporting a_s max.	65.62 ft/s ²

Contact our engineering department to meet any higher requirements: efk@murrplastik.de

MATERIAL PROPERTIES

Standard material	Polyamide (PA) black
Service temperature	-22.00 – 248.00 °F
Gliding friction factor	0.30
Static friction factor	0.45
Fire classification	Based on UL 94 HB

Other material properties on request

CHAIN BRACKET

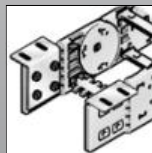

Chain bracket angle

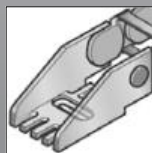

Chain bracket U-part

SHELVING SYSTEM

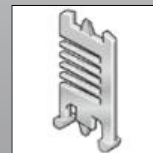

Separator TR



RS shelving system

GUIDE CHANNELS



VAW aluminum

ORDERING KEY

Type code	Variation	Inside width	Outside width	Inside width	Outside width	Radius	Rail variant	Material	Chain length
0440 30	Crossbar on outside bend Crossbar on inside bend Opens on inside and outside of bend	045 <small>[1.77]</small>	078 <small>[3.07]</small>			090 <small>[3.54]</small>	0 Plastic, full-ridged with bias	0 Polyamide (PA): standard (PA/black)	
		062 <small>[2.44]</small>	095 <small>[3.74]</small>						
		084 <small>[3.31]</small>	117 <small>[4.61]</small>			125 <small>[4.92]</small>	1 Plastic, full-ridged without bias	9 Special version (on request)	
		105 <small>[4.13]</small>	138 <small>[5.43]</small>						
		144 <small>[5.67]</small>	177 <small>[6.97]</small>			150 <small>[5.91]</small>	2 Plastic, half-ridged with bias		
		182 <small>[7.17]</small>	215 <small>[8.46]</small>						
						200 <small>[7.87]</small>	3 Plastic, half-ridged without bias		
						250 <small>[9.84]</small>	4 Aluminum full-ridged with bias		
						300 <small>[11.81]</small>	5 Aluminum full-ridged without bias		
						400 <small>[15.75]</small>	6 Aluminum half-ridged with bias		
							7 Aluminum half-ridged without bias		
							9 Special version (on request)		

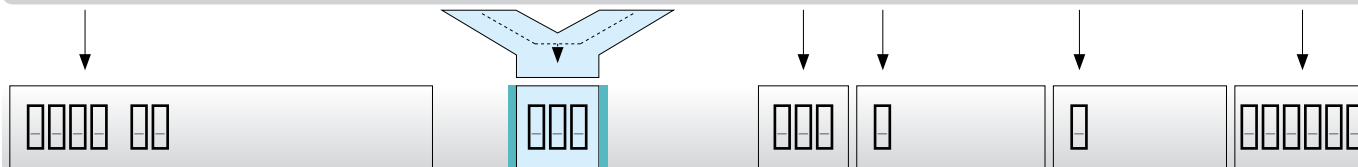

ORDERING EXAMPLE: 0440 045 090 0 0 000053

Crossbar on outside bend, crossbar on inside bend, can be opened from inside and outside bend
 Inside width 1.77 in.; radius 3.54 in.
 Plastic crossbar, full-ridged with bias, material black-colored polyamide
 Chain length 53 in. (18 links)

NOTE ON CONFIGURATION

Aluminum crossbars:

Aluminum crossbars in 0.04 in (1 mm) width sizes for inner widths from 3.03 inch – 23.62 inch are available for delivery.

Strain relief:

The end brackets utilize strain relief plates (ZL) for cable strain relief.

For detailed information, please consult the corresponding product documentation.

SELF-SUPPORTING LENGTH

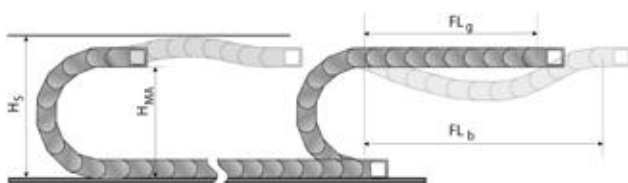

The self-supporting length is the distance between the chain bracket on the moving end and the start of the chain arch. The installation variant FL_g offers the lowest load and wear for the cable drag chain.

The maximum travel parameters (speed and acceleration) can be applied for this variant.

- H_s = Installation height plus safety
- H_{MA} = Height of moving end connection
- FL_g = Self-supporting length, upper run straight
- FL_b = Self-supporting length, upper run bent

LOAD DIAGRAM FOR SELF-SUPPORTING APPLICATIONS

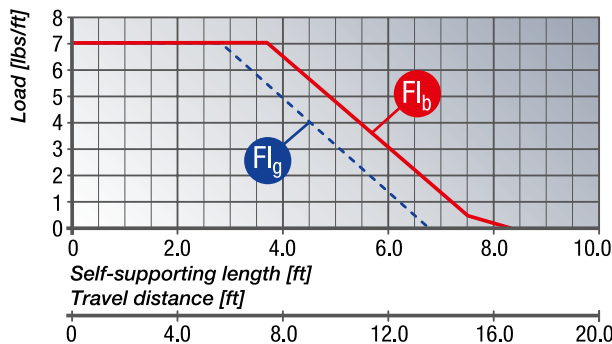

FL_g Self-supporting length, upper run straight

In the FL_g range, the chain upper run still has a bias, is straight or has a maximum sag of 2.36 inch.

FL_b Self-supporting length, upper run bent

In the FL_b range, the chain upper run has a sag of more than 2.36 inch, but this is still less than the maximum sag. Where the sag is greater than that permitted in the FL_b range, the application is critical and should be avoided. The self-supporting length can be optimized by using a support for the upper run or a more stable cable drag chain.

DETERMINING THE CHAIN LENGTH

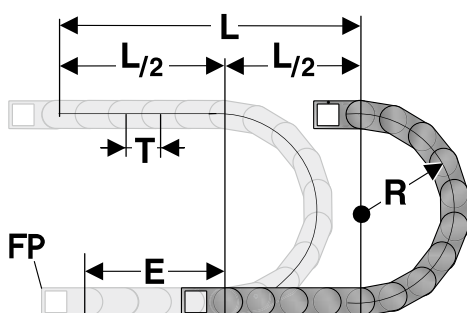

The fixed point of the cable drag chain should be connected in the middle of the travel distance.

This arrangement gives the shortest connection between the fixed point (FP) and the moving bracket and thus the most efficient chain length.

$$\text{Chain length calculation} = L/2 + \pi * R + E$$

$$\approx 1 \text{ ft chain} = 13 \text{ qty.} \times 2.97 \text{ inch.}$$

- E = Distance between entry point and middle of travel distance
- L = Travel distance
- R = Radius
- P = Grid 2.97 inch

INSTALLATION DIMENSIONS

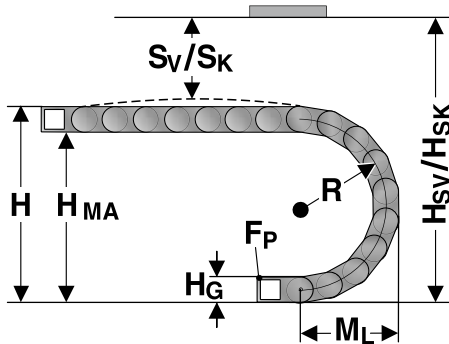

The moving end chain connection is to be screw fixed at height H_{MA} for the respective radius. Concerning the installed dimensions, you must take into account whether the chain links are equipped with or without bias. For chain links without bias, the "Installed height without bias H_{SK} " value has to be taken into account. If the chain links are equipped with a bias, the value "Installed height with bias H_{SV} " has to be taken into account.

Radius R	3.54	4.92	5.91	7.87	9.84	11.81	15.75
Outside height of chain link (H_c)	2.44	2.44	2.44	2.44	2.44	2.44	2.44
Height of bend (H)	9.52	12.28	14.26	18.18	22.12	26.06	33.94
Height of moving end connection (H_{MA})	7.08	9.84	11.82	15.74	19.68	23.62	31.50
Safety margin with bias (S_v)	1.50	1.50	1.50	1.50	1.50	1.50	1.50
Installation height with bias (H_{sv})	11.02	13.78	15.76	19.68	23.62	27.56	35.44
Safety margin without bias (S_k)	0.51	0.51	0.51	0.51	0.51	0.51	0.51
Installation height without bias (H_{sk})	10.03	12.79	14.77	18.69	22.63	26.57	34.45
Arc projection (M_L)	7.73	9.11	10.10	12.06	14.03	16.00	19.94

KA 44 CHAIN BRACKET ANGLE

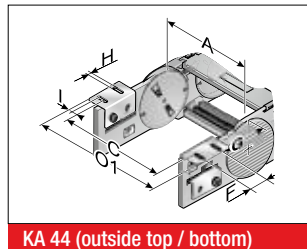
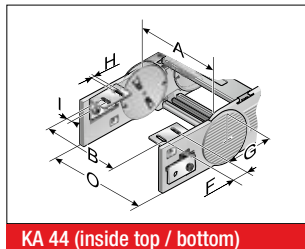

There are several options regarding the chain bracket. The fixed-point bracket (inside/bottom) and the moving end bracket (inside/top) are supplied as standard. However, any other combination can be supplied upon request. The chain bracket is fastened at the end like a side link. This enables the chain to move right up to the bracket. Each chain requires two chain brackets. The brackets should be fastened with M6 screws.

Type	Order No.	Material	Inside width								Outside width of KA 0	Outside width of KA 01	
			A inch	B inch	C inch	E inch	F inch	G inch	G1 inch	H0 inch			I inch
KA 44	0440000050	Sheet steel	2.44 – 7.17	A-0.57	A+1.52	A+1.26	1.26	1.70	3.39	0.26	0.49	A+1.30	A+2.52
KA 44	0440000052	Stainless steel 1.4301	2.44 – 7.17	A-0.57	A+1.52	A+1.26	1.26	1.70	3.39	0.26	0.49	A+1.30	A+2.52

KA 44 CHAIN BRACKET U-PART

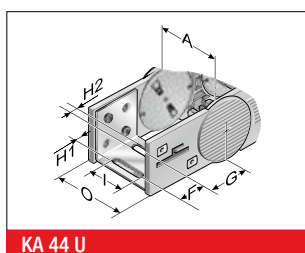

The chain bracket is an all-plastic part. The bracket is precisely adjusted to the respective chain width and only needs to be snapped in at the chain link. Please order one male and one female end bracket for each chain. The brackets should be fastened with M5 screws. The cables or conduits may be fastened with cable ties on the integrated strain relief of the chain bracket.

Type	Order No.	Material	Inside width					Outside width of KA 0	
			A inch	F inch	G inch	H1 inch	H2 inch		I inch
KA 44 U	0440000054	Stainless steel 1.4301	1.77	1.10	1.77	0.26	0.33	1.30	A+1.30

MP 44 OPEN

MP 44 SEPARATOR

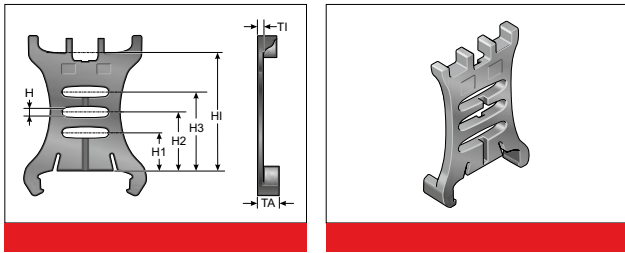

We recommend that separators be used if multiple round cables or conduits with differing diameters are to be installed. For applications with aluminum crossbars or when movable separators are to be used, the TL 44 separator should be used.

Type	Order No.	Description	TI inch	TA inch	H inch	H1 inch	H2 inch	H3 inch	H4 inch	H5 inch
TF 44	044000009400	Separator	0.16	0.33	0.17	0.52	0.81	1.09	1.61	
TL 44	044000009200	Separator for aluminum crossbars	0.16	0.33	0.17	0.52	0.81	1.09	1.61	

SHELVING SYSTEM MP 44

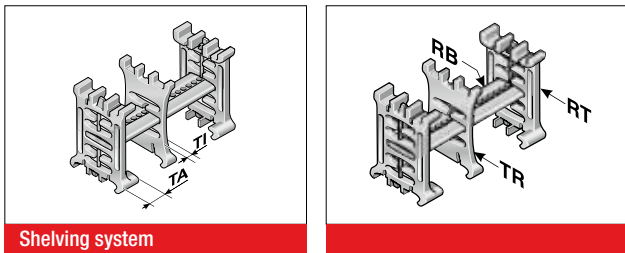

The shelf must be used with a minimum of two separators to create a shelving system. The additional levels prevent cables from criss-crossing and minimize the friction between them. The shelving system may be preassembled on request.

Type	Order No.	Description	Width inch	Clearance width inch	Lock grid spacing inch	TI inch	H1 inch	H2 inch	H3 inch	H4 inch	H5 inch
RB 031	100000003100	Shelf	1.65	1.22	0.06						
RB 048	100000004800	Shelf	2.32	1.89	0.06						
RB 070	100000007000	Shelf	3.19	2.76	0.06						
RB 092	100000009200	Shelf	4.06	3.62	0.06						
RB 100	100000010000	Shelf	4.37	3.94	0.06						
RB 128	100000012800	Shelf	5.47	5.04	0.06						
RB 167	100000016700	Shelf	7.01	6.57	0.06						
RT 44	1000902100	Shelf support	0.17		0.06	0.26	0.25	0.52	0.81	1.09	1.37

VAW GUIDE CHANNEL



A variable guide channel system, constructed from aluminum sections, is available for this cable drag chain. The variable guide channel ensures that the cable drag chain is supported and guided securely.

ASSEMBLY

DISASSEMBLY

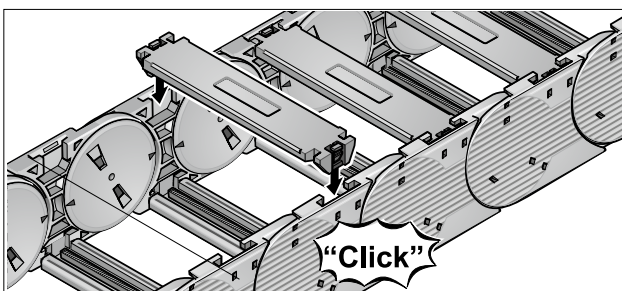
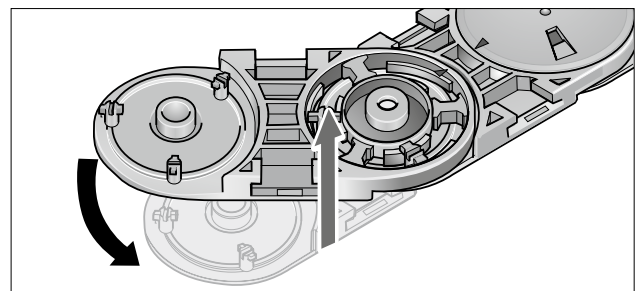
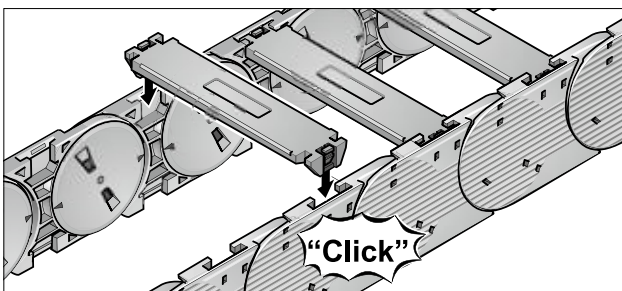
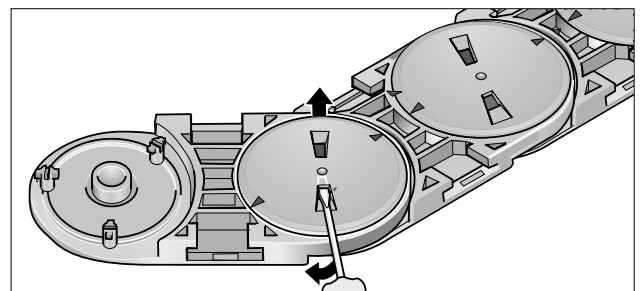
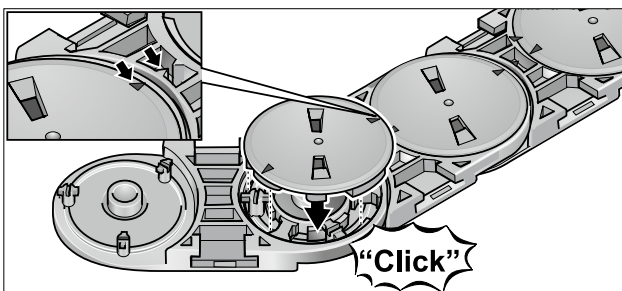
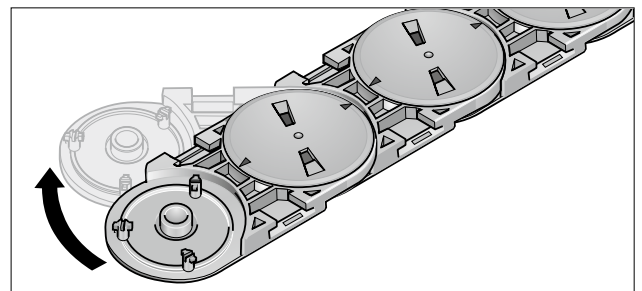
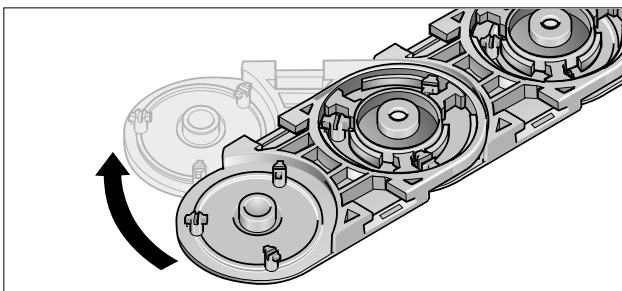
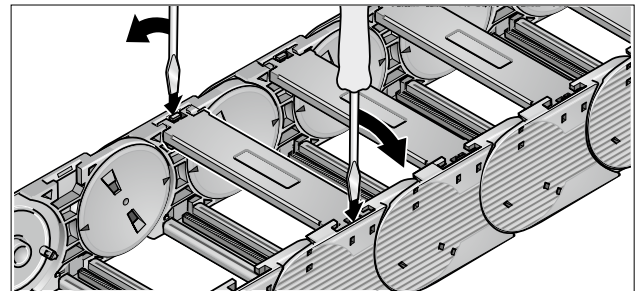
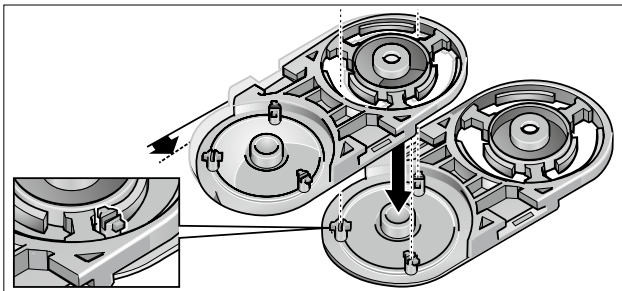

MP 52.1 OPEN



- PLASTIC OR ALUMINUM VERSION
- CHAIN BRACKET FLEXIBLE

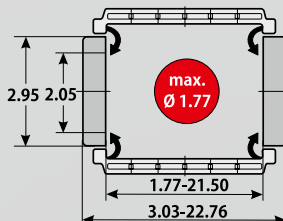

TECHNICAL DATA

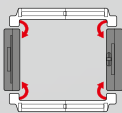

Loading side
Inside and outside bend

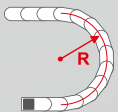

Available radii
3.94 – 13.78 inch

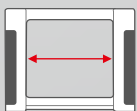

Available interior widths
With plastic crossbar
1.77 – 21.5 inch
With aluminum crossbar / cover
2.64 – 23.62 inch /

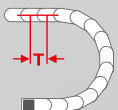

Grid
T = 3.58 inch

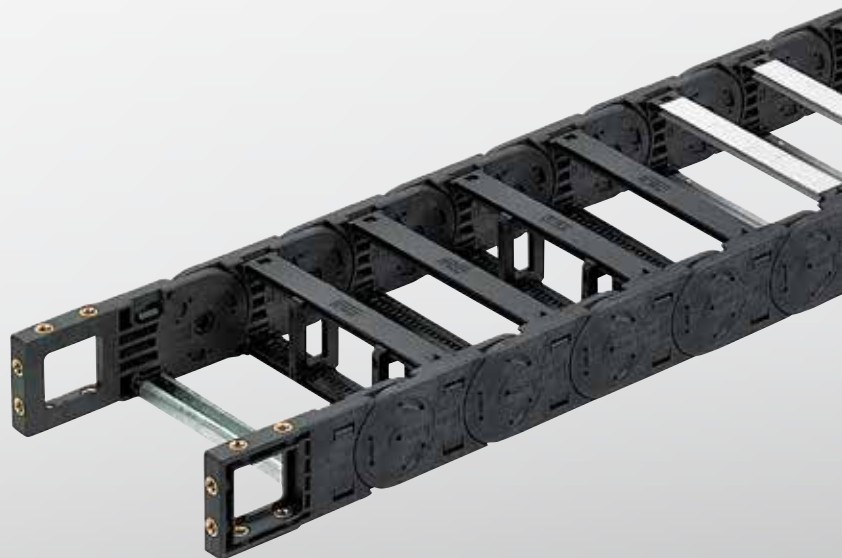
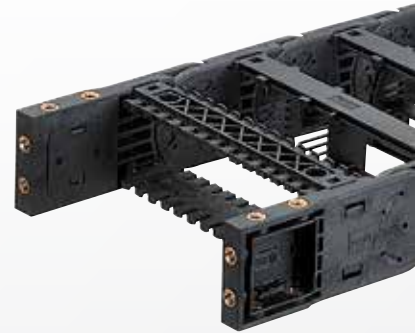



TECHNICAL SPECIFICATIONS

Travel distance gliding L_g max.	492.13 ft.
Travel distance self-supporting L_s max.	see diagram on page 377
Travel distance vertical, hanging L_{vh} max.	196.85 ft.
Travel distance vertical, upright L_{vs} max.	19.69 ft.
Rotated 90°, unsupported L_{90f} max.	9.84 ft.
Speed, gliding V_g max.	16.40 ft/s
Speed, self-supporting V_f max.	65.62 ft/s
Acceleration, gliding a_g max.	82.02 ft/s ²
Acceleration, self-supporting a_s max.	98.43 ft/s ²

Contact our engineering department to meet any higher requirements: efk@murrplastik.de

MATERIAL PROPERTIES

Standard material	Polyamide (PA) black
Service temperature	-22.00 – 248.00 °F
Gliding friction factor	0.30
Static friction factor	0.45
Fire classification	UL 94 HB

Other material properties on request

SHELVING SYSTEM



Separator TR

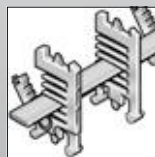

RS shelving system

CHAIN BRACKET

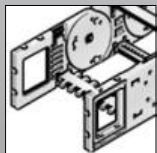

Chain bracket flexible

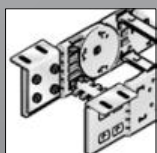

Chain bracket angle



Crossbar connector RSV



H-shaped shelf unit RE

ACCESSORIES



Bracket bar

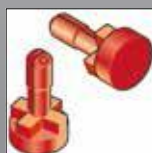

Lock button

GUIDE CHANNELS



VAW steel galvanized / stainless steel

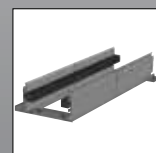

VAW aluminum

STRAIN RELIEF



RS-ZL crossbar strain relief



STF Steel Fix

ORDERING KEY

Type code	Variation	Inside width	Outside width	Inside width	Outside width	Radius	Rail variant	Material	Chain length
0521 30	Crossbar on outside bend Crossbar on inside bend Opens on inside and outside of bend	045 [1.77]	077 [3.03]	233 [9.17]	265 [10.43]	100 [3.94]	0 Plastic, full-ridged with bias	0 Polyamide (PA): standard (PA/black)	
		057 [2.24]	089 [3.50]	246 [9.69]	278 [10.94]				
		062 [2.44]	094 [3.70]	252 [9.92]	284 [11.18]	150 [5.91]	1 Plastic, full-ridged without bias	9 Special version (on request)	
		071 [2.80]	103 [4.06]	258 [10.16]	290 [11.42]				
		084 [3.31]	116 [4.57]	296 [11.65]	328 [12.91]	200 [7.87]	2 Plastic, half-ridged with bias		
		093 [3.66]	125 [4.92]	346 [13.62]	378 [14.88]				
		096 [3.78]	128 [5.04]	350 [13.78]	382 [15.04]	250 [9.84]	3 Plastic, half-ridged without bias		
		104 [4.09]	136 [5.35]	358 [14.09]	390 [15.35]				
		107 [4.21]	139 [5.47]	371 [14.61]	403 [15.87]	300 [11.81]	4 Aluminum full-ridged with bias		
		121 [4.76]	153 [6.02]	396 [15.59]	428 [16.85]				
		133 [5.24]	165 [6.50]	421 [16.57]	453 [17.83]	350 [13.78]	5 Aluminum full-ridged without bias		
		144 [5.67]	176 [6.93]	446 [17.56]	478 [18.82]				
		146 [5.75]	178 [7.01]	496 [19.53]	528 [20.79]		6 Aluminum half-ridged with bias		
		158 [6.22]	190 [7.48]	546 [21.50]	578 [22.76]				
		164 [6.46]	196 [7.72]				7 Aluminum half-ridged without bias		
		171 [6.73]	203 [7.99]						
		182 [7.17]	214 [8.43]				9 Special version (on request)		
		196 [7.72]	228 [8.98]						
		208 [8.19]	240 [9.45]						
		220 [8.66]	252 [9.92]						



ORDERING EXAMPLE: 0521 045 100 0 0 000053

Crossbar on outside bend, crossbar on inside bend, can be opened from inside and outside bend
 Inside width 1.77 in.; radius 3.94 in.
 Plastic crossbar, full-ridged with bias, material black-colored polyamide
 Chain length 53 in. (15 links)

NOTE ON CONFIGURATION

Aluminum crossbars:

Aluminum crossbars in 0.04 in (1 mm) width sizes for inner widths from 2.64 inch – 23.62 inch are available for delivery.

Crossbar connector and crossbar strain relief plate:

Once inside widths exceed 9.69 inches (246 mm), we recommend the deployment of crossbar connectors (RSV). If crossbar strain relief plates (RS-ZL) are to be deployed in the chain brackets, take standard inside widths into account.

For detailed information, please consult the corresponding product documentation.

SELF-SUPPORTING LENGTH

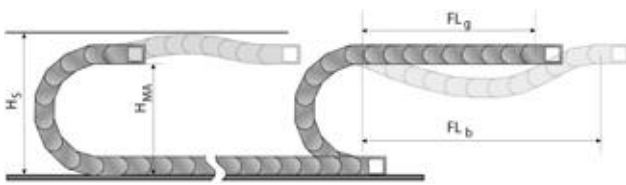

The self-supporting length is the distance between the chain bracket on the moving end and the start of the chain arch. The installation variant FL_g offers the lowest load and wear for the cable drag chain. The maximum travel parameters (speed and acceleration) can be applied for this variant.

- H_s = Installation height plus safety
- H_{MA} = Height of moving end connection
- FL_g = Self-supporting length, upper run straight
- FL_b = Self-supporting length, upper run bent

LOAD DIAGRAM FOR SELF-SUPPORTING APPLICATIONS

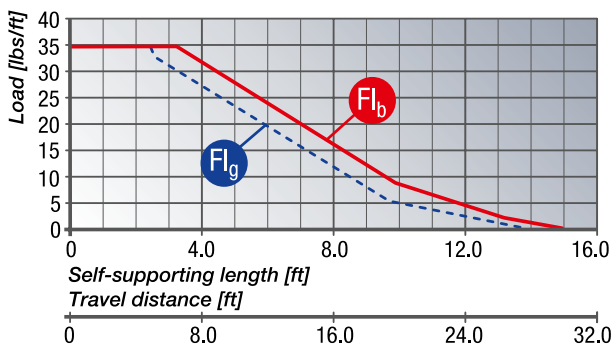

FL_g Self-supporting length, upper run straight

In the FL_g range, the chain upper run still has a bias, is straight or has a maximum sag of 2.76 inch.

FL_b Self-supporting length, upper run bent

In the FL_b range, the chain upper run has a sag of more than 2.76 inch, but this is still less than the maximum sag. Where the sag is greater than that permitted in the FL_b range, the application is critical and should be avoided. The self-supporting length can be optimized by using a support for the upper run or a more stable cable drag chain.

DETERMINING THE CHAIN LENGTH

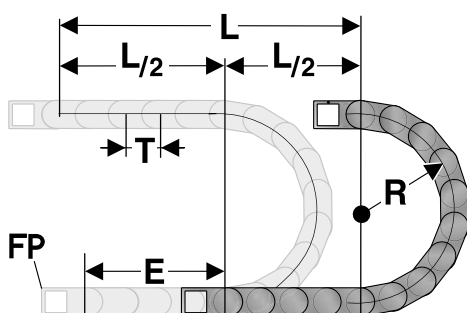

The fixed point of the cable drag chain should be connected in the middle of the travel distance.

This arrangement gives the shortest connection between the fixed point (FP) and the moving bracket and thus the most efficient chain length.

$$\text{Chain length calculation} = L/2 + \pi * R + E$$

$$\approx 1 \text{ ft chain} = 11 \text{ qty.} \times 3.58 \text{ inch.}$$

- E = Distance between entry point and middle of travel distance
- L = Travel distance
- R = Radius
- P = Grid 3.58 inch

INSTALLATION DIMENSIONS

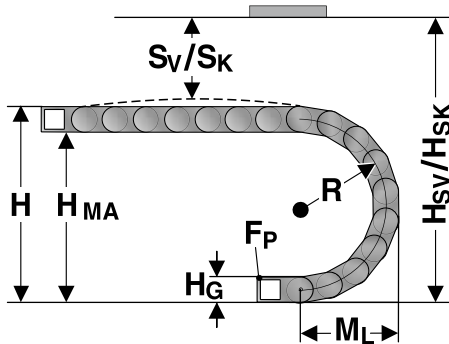

The moving end chain connection is to be screw fixed at height H_{MA} for the respective radius.

Concerning the installed dimensions, you must take into account whether the chain links are equipped with or without bias.

For chain links without bias, the "Installed height without bias H_{SK} " value has to be taken into account.

If the chain links are equipped with a bias, the value "Installed height with bias H_{SV} " has to be taken into account.

Radius R	3.94	5.91	7.87	9.84	11.81	13.78
Outside height of chain link (H_e)	2.95	2.95	2.95	2.95	2.95	2.95
Height of bend (H)	12.01	15.95	19.87	23.81	27.75	31.69
Height of moving end connection (H_{MA})	9.06	13.00	16.92	20.86	24.80	28.74
Safety margin with bias (S_v)	1.81	1.81	1.81	1.81	1.81	1.81
Installation height with bias (H_{sv})	13.82	17.76	21.68	25.62	29.56	33.50
Safety margin without bias (S_k)	0.63	0.63	0.63	0.63	0.63	0.63
Installation height without bias (H_{sk})	12.64	16.58	20.50	24.44	28.38	32.32
Arc projection (M_L)	9.59	11.56	13.52	15.49	17.45	19.42

POWERLINE PLASTIC CROSSBAR



Crossbar

The crossbars connect the two side runs of the cable drag chain. The crossbar length is synonymous with the inside width of the cable drag chain.

Type	Order No.	Description	Inside width inch
BS 045-5	052004500000	Crossbar	1.77
BS 057-5	052005700000	Crossbar	2.24
BS 062-5	052006200000	Crossbar	2.44
BS 071-5	052007100000	Crossbar	2.80
BS 084-5	052008400000	Crossbar	3.31
BS 093-5	052009300000	Crossbar	3.66
BS 096-5	052009600000	Crossbar	3.78
BS 104-5	052010400000	Crossbar	4.09
BS 107-5	052010700000	Crossbar	4.21
BS 121-5	052012100000	Crossbar	4.76
BS 133-5	052013300000	Crossbar	5.24
BS 144-5	052014400000	Crossbar	5.67
BS 146-5	052014600000	Crossbar	5.75
BS 158-5	052015800000	Crossbar	6.22
BS 164-5	052016400000	Crossbar	6.46

POWERLINE PLASTIC CROSSBAR

Type	Order No.	Description	Inside width inch
BS 171-5	052017100000	Crossbar	6.73
BS 182-5	052018200000	Crossbar	7.17
BS 196-5	052019600000	Crossbar	7.72
BS 208-5	052020800000	Crossbar	8.19
BS 220-5	052022000000	Crossbar	8.66
BS 233-5	052023300000	Crossbar	9.17
BS 246-5	052024600000	Crossbar	9.69
BS 252-5	052025200010	Crossbar	9.92
BS 258-5	052025800000	Crossbar	10.16
BS 296-5	052029600000	Crossbar	11.65
BS 346-5	052034600000	Crossbar	13.62
BS 350-5	052035000000	Crossbar	13.78
BS 358-5	052035800000	Crossbar	14.09
BS 371-5	052037100000	Crossbar	14.61
BS 396-5	052039600000	Crossbar	15.59
BS 421-5	052042100000	Crossbar	16.57
BS 446-5	052044600000	Crossbar	17.56
BS 496-5	052049600000	Crossbar	19.53
BS 546-5	052054600000	Crossbar	21.50

KA 52.1 CHAIN BRACKET FLEXIBLE

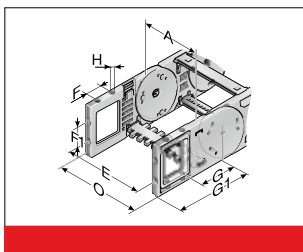

This chain bracket offers universal connection options (top, bottom and front) and is attached to the ends of the chain like a side link. This allows the chain to move right up to the bracket. Each chain requires one male and one female bracket. M8 screws are used to secure the brackets in place. Extrusion-coated metal bushes with either a through-hole (-FB) or a threaded hole (-FG) ensure the permanent, high-strength transmission of even extreme forces onto the cable drag chain.

Type	Order No.	Material	Version	Inside width							Outside width of KA O inch
				A inch	E inch	F inch	F1 inch	G inch	G1 inch	H inch	
KA 52.1-FB Female end	0521000056	Plastic	with bush	1.77 – 21.50	A+0.63	1.38	1.18	3.50	5.75	0.33	A+1.42
KA 52.1-FB male end	0521000057	Plastic	with bush	1.77 – 21.50	A+0.63	1.38	1.18	3.50	5.75	0.33	A+1.42
KA 52.1-FG female end	0521000058	Plastic	with thread	1.77 – 21.50	A+0.63	1.38	1.18	3.50	5.75	M8	A+1.42
KA 52.1-FG male end	0521000059	Plastic	with thread	1.77 – 21.50	A+0.63	1.38	1.18	3.50	5.75	M8	A+1.42

KA 52.1 CHAIN BRACKET ANGLE

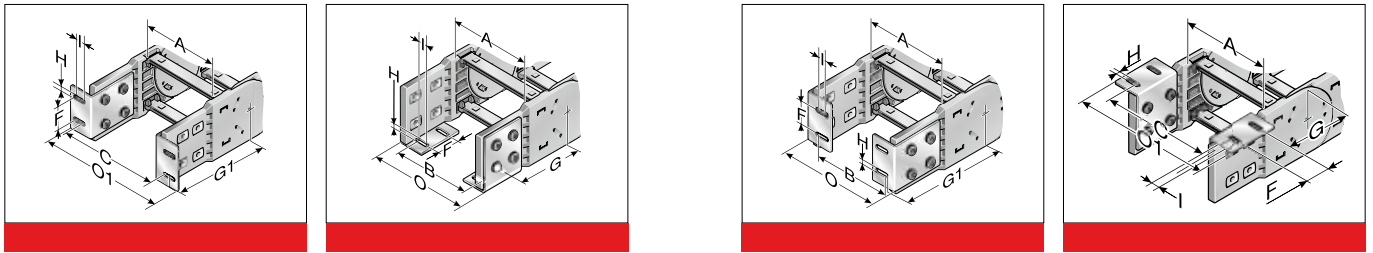

There are several options regarding the chain bracket. The fixed-point bracket (inside/bottom) and the moving end bracket (inside/top) are supplied as standard. However, any other combination can be supplied upon request. The chain bracket

is fastened at the end like a side link. This enables the chain to move right up to the bracket. Each chain requires one male and one female bracket. The brackets should be fastened with M6 screws.

Type	Order No.	Material	Inside width								Outside width of KA 0	Outside width of KA 01
			A inch	B inch	C inch	F inch	G inch	G1 inch	HØ inch	I inch		
KA 52.1 Female end	0521000050	Sheet steel	1.77 – 21.50	A-0.10	A+1.36	1.26	3.76	5.67	0.26	0.55	A+1.26	A+2.80
KA 52.1 Male end	0521000051	Sheet steel	1.77 – 21.50	A-0.10	A+1.36	1.26	3.76	5.67	0.26	0.55	A+1.26	A+2.80

TR 52 SEPARATOR

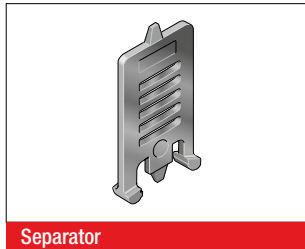
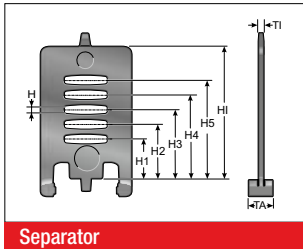

We recommend that separators be used if multiple round cables or conduits with differing diameters are to be installed. The closed separator is used when no shelves are used. This is the recommended design for travel paths of 98.42 ft (30 m) or greater.

Type	Order No.	Description	Version	TI inch	TA inch	H inch	H1 inch	H2 inch	H3 inch	H4 inch	H5 inch	H1 inch
TR 52	052000009200	TR 52 Separator	lockable	0.14	0.39	0.17	0.64	0.88	1.11	1.33	1.57	2.05

TR 52.1 SEPARATOR

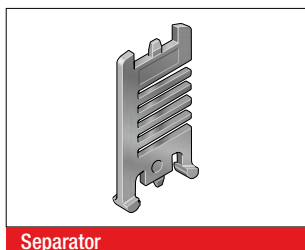
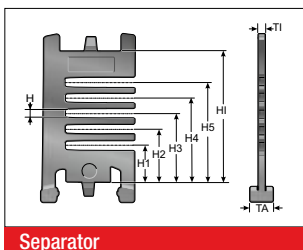

We recommend that separators be used if multiple round cables or conduits with differing diameters are to be installed.

Type	Order No.	Description	Version	TI inch	TA inch	H inch	H1 inch	H2 inch	H3 inch	H4 inch	H5 inch	H1 inch
TR 52.1	052100009200	TR 52.1 Separator	lockable	0.14	0.31	0.16	0.61	0.87	1.11	1.36	1.61	2.05

TR 52-V SEPARATOR

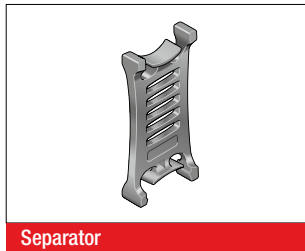
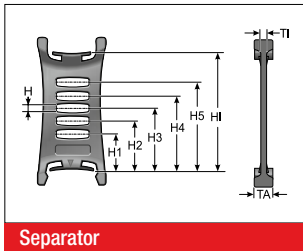

We recommend that separators be used if multiple round cables or conduits with differing diameters are to be installed.

Type	Order No.	Description	Version	TI inch	TA inch	H inch	H1 inch	H2 inch	H3 inch	H4 inch	H5 inch	Hl inch
TR 52-V	052000009300	TR 52-V Separator	movable	0.14	0.51	0.16	0.64	0.88	1.11	1.33	1.57	2.05

RTT 52 SHELF SUPPORT, DIVISIBLE

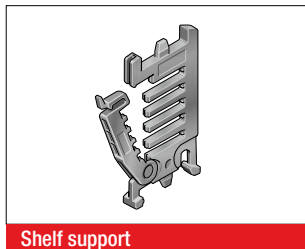
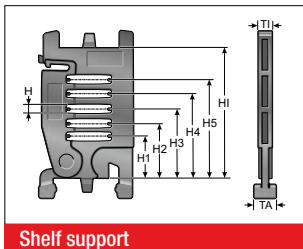

In connection with two separable shelf supports (RTT) with at least one end-to-end shelf (RB) the shelf becomes an easy to fill shelving system. The additional levels prevent cables from criss-crossing and minimize the friction between them.

Type	Order No.	Description	Version	TI inch	TA inch	H inch	H1 inch	H2 inch	H3 inch	H4 inch	H5 inch	Hl inch
RTT 52	100090522000	Shelf support, divisible	lockable	0.28	0.31	0.16	0.61	0.87	1.11	1.36	1.61	2.05

RB-5 SHELF

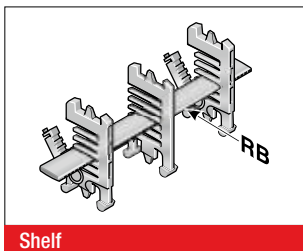

In connection with at least two separable shelf supports (RTT), the shelf becomes a shelving system. The additional levels prevent cables from criss-crossing and minimize the friction between them.

Type	Order No.	Description	Width inch	Inside width inch
RB 028-5	100000002800	Shelf	1.10	1.77
RB 034-5	1000003405	Shelf	1.32	1.77
RB 039-5	1000003905	Shelf	1.54	1.77
RB 045-5	1000004505	Shelf	1.76	2.24
RB 050-5	1000005005	Shelf	1.98	2.24
RB 056-5	100000005601	Shelf	2.20	2.44
RB 062-5	1000006205	Shelf	2.43	2.44
RB 067-5	1000006705	Shelf	2.65	3.31
RB 073-5	1000007305	Shelf	2.87	3.31
RB 078-5	1000007805	Shelf	3.09	3.31
RB 084-5	10000008400	Shelf	3.31	3.31
RB 090-5	1000009005	Shelf	3.53	3.78
RB 095-5	1000009505	Shelf	3.75	3.78
RB 101-5	1000010105	Shelf	3.97	4.21
RB 106-5	1000010605	Shelf	4.19	4.21

RB-5 SHELF

Type	Order No.	Description	Width inch	Inside width inch
RB 112-5	10000011200	Shelf	4.41	4.76
RB 118-5	1000011805	Shelf	4.63	4.76
RB 123-5	1000012305	Shelf	4.85	5.24
RB 129-5	1000012905	Shelf	5.07	5.24
RB 134-5	1000013405	Shelf	5.29	5.67
RB 140-5	10000014000	Shelf	5.51	5.67
RB 146-5	1000014605	Shelf	5.73	6.22
RB 151-5	1000015105	Shelf	5.95	6.22
RB 157-5	1000015705	Shelf	6.17	6.46
RB 162-5	1000016205	Shelf	6.39	6.46
RB 168-5	10000016800	Shelf	6.61	7.17
RB 174-5	1000017405	Shelf	6.83	7.17
RB 179-5	1000017905	Shelf	7.06	7.72
RB 185-5	1000018505	Shelf	7.28	7.72
RB 190-5	1000019005	Shelf	7.50	7.72
RB 196-5	10000019600	Shelf	7.72	7.72
RB 291-5	100000029100	Shelf	11.46	13.62

RSV 52 CROSSBAR CONNECTOR



For crossbars wider than 9.69 inch (246 mm), we recommend the use of crossbar connectors. These prevent deformation to the crossbar under large amounts of additional weight of the chain assembly.

Type	Order No.	Description	TI inch
RSV 52	052000009600	Crossbar connector	0.30
RSV 52 Alu	052000009800	Crossbar connector for aluminum crossbars	0.30

RE 52 H-SHAPED SHELF UNIT

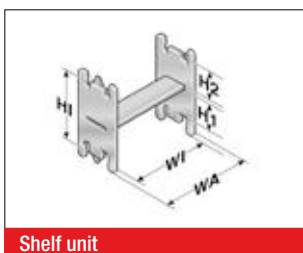

One-piece shelving system, the shelf cannot be varied in height.

Type	Order No.	Description	WA inch	WI inch	H1 inch	H2 inch	HI inch
RE 36/17	100000361714	H-shaped shelf unit	1.67	1.44	1.22	0.69	2.05
RE 59/24	100000592414	H-shaped shelf unit	2.56	2.32	0.95	0.95	2.05
RE 81/12	100000811214	H-shaped shelf unit	3.44	3.21	1.42	0.49	2.05

BS-5 BRACKET BAR



Large-diameter conduits are routed securely by using bracket bars (BS). This bar is installed on the crossbars or the covers of the cable drag chain. The bracket bar can be installed on both the inside and outside bend.

The bracket bar support (BSH) is used to attach the bars to PowerLine series crossbars. Two bracket bar supports are required for each bar.

Type	Order No.	Description	Conduit diameter max. inch	Installation height inch	Inner chain width min. inch
BS 120-5	052412000000	Bracket bar	4.53	5.51	6.46
BS 153-5	052415300000	Bracket bar	5.83	6.69	8.19
BS 187-5	052418700000	Bracket bar	7.17	8.07	9.17
BSH-5	052400000000	Bracket bar support			
Assembly set	052400000001	Assembly set			

RS-ZL-5 CROSSBAR STRAIN RELIEF PLATE

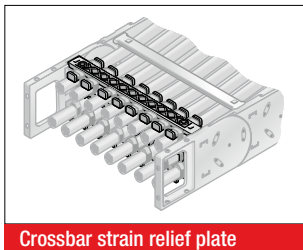

Crossbar strain relief plate

Fixed integrated crossbar strain relief plates in the chain brackets. Tailored to all crossbar widths up to 9.69 inch (246 mm). May be assembled on the inside and outside bends at both chain endings.

Type	Order No.	Description	Inside width inch
RS-ZL 045-5	052004500010	Crossbar strain relief plate	1.77
RS-ZL 057-5	052005700010	Crossbar strain relief plate	2.24
RS-ZL 062-5	052006200010	Crossbar strain relief plate	2.44
RS-ZL 071-5	052007100010	Crossbar strain relief plate	2.80
RS-ZL 084-5	052008400010	Crossbar strain relief plate	3.31
RS-ZL 093-5	052009300010	Crossbar strain relief plate	3.66
RS-ZL 096-5	052009600010	Crossbar strain relief plate	3.78
RS-ZL 104-5	052010400010	Crossbar strain relief plate	4.09
RS-ZL 107-5	052010700010	Crossbar strain relief plate	4.21
RS-ZL 121-5	052012100010	Crossbar strain relief plate	4.76
RS-ZL 133-5	052013300010	Crossbar strain relief plate	5.24
RS-ZL 144-5	052014400010	Crossbar strain relief plate	5.67
RS-ZL 146-5	052014600010	Crossbar strain relief plate	5.75
RS-ZL 158-5	052015800010	Crossbar strain relief plate	6.22
RS-ZL 164-5	052016400010	Crossbar strain relief plate	6.46
RS-ZL 171-5	052017100010	Crossbar strain relief plate	6.73
RS-ZL 182-5	052018200010	Crossbar strain relief plate	7.17
RS-ZL 196-5	052019600010	Crossbar strain relief plate	7.72
RS-ZL 208-5	052020800010	Crossbar strain relief plate	8.19
RS-ZL 220-5	052022000010	Crossbar strain relief plate	8.66
RS-ZL 233-5	052023300010	Crossbar strain relief plate	9.17
RS-ZL 246-5	052024600010	Crossbar strain relief plate	9.69

STRAIN RELIEF WITH STEEL FIX

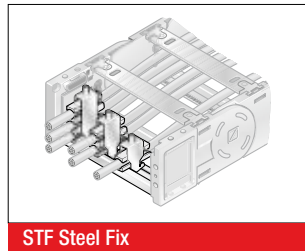
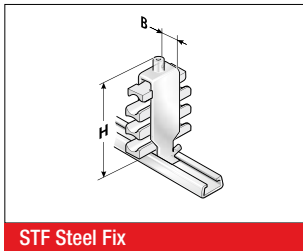

C-rails (galvanized) for permanent integration, for accommodating the Steel Fix bow clamps in the chain brackets. The bow clamps can take up to 3 cables and are suitable for C-rails with a groove width of 0.43 in (11 mm). Due to the design of the trough elements, a cable preserving cable guidance is ensured. May be assembled on the inside and outside bends at both chain endings. The overall height stated is a guide only. The actual height is, amongst other things, dependent on the diameter and the quality of the cable. A safety distance of 0.39 in (10 mm) at the fixed point above the strain relief must be kept during gliding applications.

Type	Order No.	Description	Seats qty.	Cable Ø inch	Width (B) inch	Total height (H) inch
Single clamp (for one cable)						
STF 12-1 Steel Fix	81661801	Hooped clamp	1	0.24 – 0.47	0.63	2.17
STF 14-1 Steel Fix	81661802	Hooped clamp	1	0.47 – 0.55	0.71	2.05
STF 16-1 Steel Fix	81661803	Hooped clamp	1	0.55 – 0.63	0.79	2.13
STF 18-1 Steel Fix	81661804	Hooped clamp	1	0.63 – 0.71	0.87	2.20
STF 20-1 Steel Fix	81661805	Hooped clamp	1	0.71 – 0.79	0.94	2.32
STF 22-1 Steel Fix	81661806	Hooped clamp	1	0.79 – 0.87	1.02	2.40
STF 26-1 Steel Fix	81661807	Hooped clamp	1	0.87 – 1.02	1.18	2.76
STF 30-1 Steel Fix	81661808	Hooped clamp	1	1.02 – 1.18	1.34	2.91
STF 34-1 Steel Fix	81661809	Hooped clamp	1	1.18 – 1.34	1.50	3.07
STF 38-1 Steel Fix	81661810	Hooped clamp	1	1.34 – 1.50	1.65	3.23
STF 42-1 Steel Fix	81661811	Hooped clamp	1	1.50 – 1.65	1.81	3.58
Double clamp (for two cables)						
STF 12-2 Steel Fix	81661821	Hooped clamp	2	0.24 – 0.47	0.63	2.87
STF 14-2 Steel Fix	81661822	Hooped clamp	2	0.47 – 0.55	0.71	2.91
STF 16-2 Steel Fix	81661823	Hooped clamp	2	0.55 – 0.63	0.79	3.23
STF 18-2 Steel Fix	81661824	Hooped clamp	2	0.63 – 0.71	0.87	3.39
STF 20-2 Steel Fix	81661825	Hooped clamp	2	0.71 – 0.79	0.94	3.58
STF 22-2 Steel Fix	81661826	Hooped clamp	2	0.79 – 0.87	1.02	3.74
STF 26-2 Steel Fix	81661827	Hooped clamp	2	0.87 – 1.02	1.18	4.25
STF 30-2 Steel Fix	81661828	Hooped clamp	2	1.02 – 1.18	1.34	4.76
STF 34-2 Steel Fix	81661829	Hooped clamp	2	1.18 – 1.34	1.50	5.08
Triple clamp (for three cables)						
STF 12-3 Steel Fix	81661841	Hooped clamp	3	0.24 – 0.47	0.63	3.86
STF 14-3 Steel Fix	81661842	Hooped clamp	3	0.47 – 0.55	0.71	3.86
STF 16-3 Steel Fix	81661843	Hooped clamp	3	0.55 – 0.63	0.79	4.13
STF 18-3 Steel Fix	81661844	Hooped clamp	3	0.63 – 0.71	0.87	4.37
STF 20-3 Steel Fix	81661845	Hooped clamp	3	0.71 – 0.79	0.94	4.65
STF 22-3 Steel Fix	81661846	Hooped clamp	3	0.79 – 0.87	1.02	5.12

MP 52/62/72 LOCK BUTTON

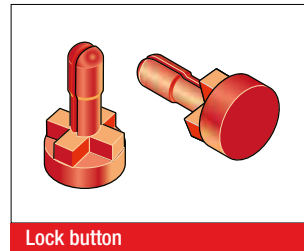
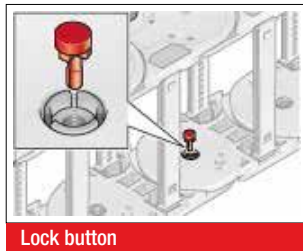
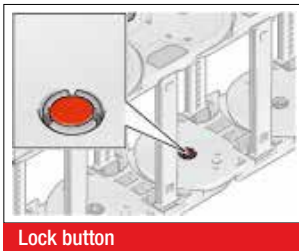

To increase the side stability we recommend the use of lock buttons during strong lateral acceleration or when installed “laying

on the side (turned 90°) without support”.

Type	Order No.
MP52/62/72 lock button	0520000080

MP 52.1 REARWARD RADII

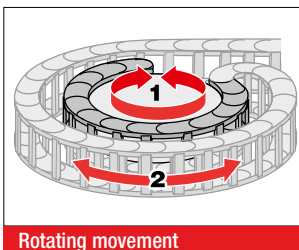

Side links with forward radius (R) and rearward radius (Rü) allow movements in both directions. This is intended for rotating movements and lowered chain brackets. Note: This type of chain has different chain links for the left or right side! Rotation movements are only possible with open variants.

Type	Order No.	Radius inch	Back radius inch
SR 52.1 (RÜ200/R300) left	052100030060	11.81	7.87
SR 52.1 (RÜ200/R300) right	052100030062	11.81	7.87

GUIDE CHANNEL VAW (ALUMINUM / STAINLESS STEEL)



A range of variable guide channel systems, constructed from aluminum or stainless steel sections, is available for this cable drag chain. The variable guide channel ensures that the cable drag chain is supported and guided securely.

ASSEMBLY INSTRUCTION FLEXIBLE CHAIN BRACKET FB/FG

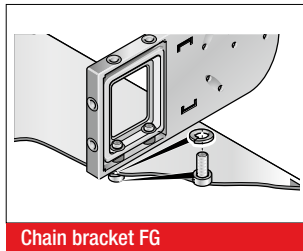
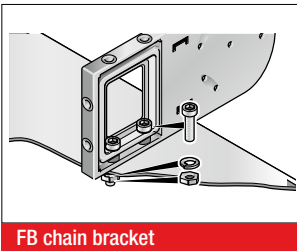

Brass bushes guarantee long-lasting fastening without cold flow in the plastic.

Version KA-FB:

Integrated through-hole fastened down using nut and bolt.

Version KA-FG:

Built-in threads allow for quick and easy on-site mounting, since a screw, including a retaining washer where necessary, is sufficient.

ASSEMBLY

DISASSEMBLY

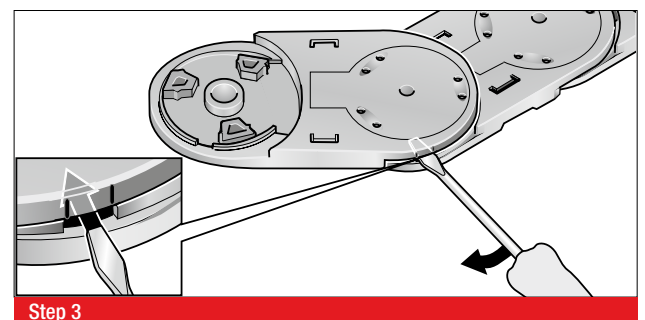
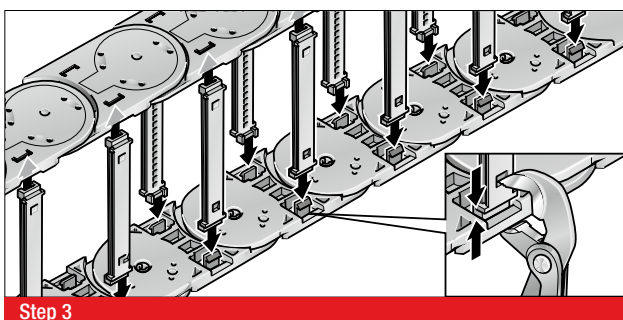
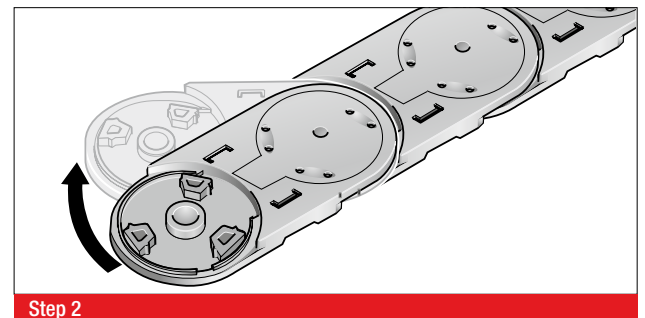
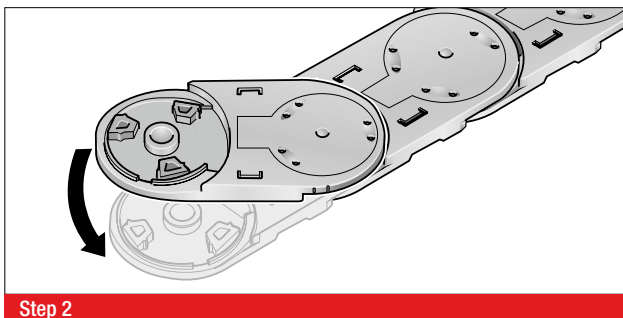
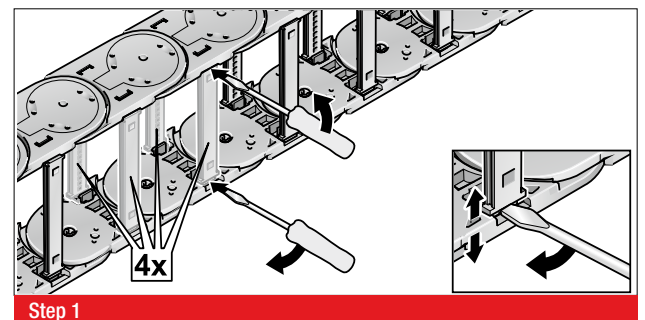
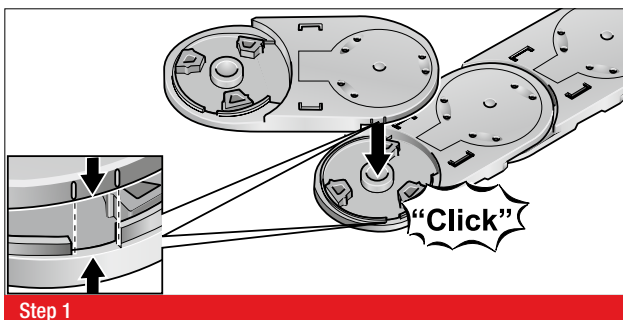

MP 62.1 OPEN



- PLASTIC OR ALUMINUM VERSION
- CHAIN BRACKET FLEXIBLE

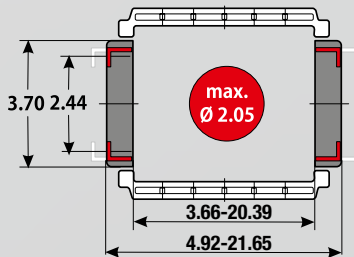

TECHNICAL DATA

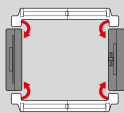

Loading side
Inside and outside bend

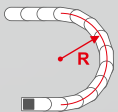

Available radii
5.91 – 19.69 inch

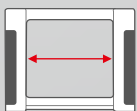

Available interior widths
With plastic crossbar
3.66 – 20.39 inch
With aluminum crossbar / cover
2.83 – 23.62 inch /

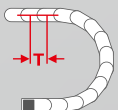

Grid
T = 3.94 inch

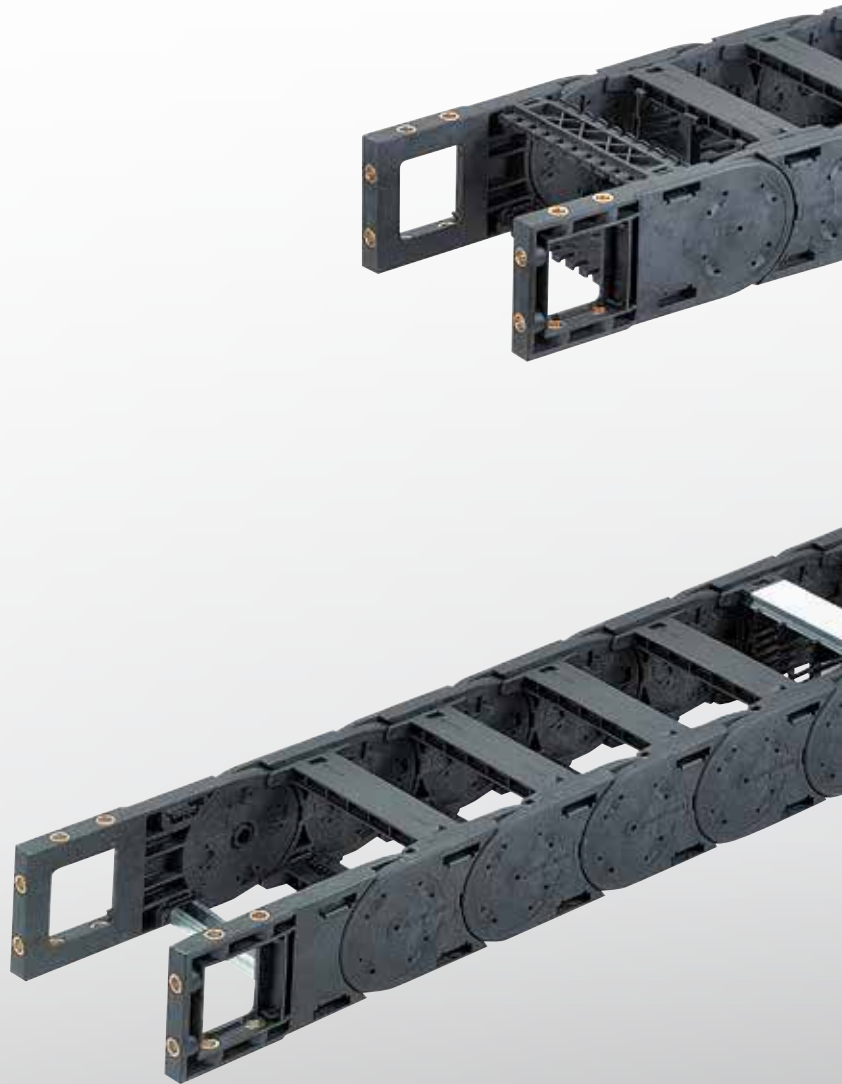



TECHNICAL SPECIFICATIONS

Travel distance gliding L_g max.	492.13 ft.
Travel distance self-supporting L_s max.	see diagram on page 391
Travel distance vertical, hanging L_{vh} max.	213.25 ft.
Travel distance vertical, upright L_{vs} max.	19.69 ft.
Rotated 90°, unsupported L_{90f} max.	13.12 ft.
Speed, gliding V_g max.	16.40 ft/s
Speed, self-supporting V_f max.	65.62 ft/s
Acceleration, gliding a_g max.	82.02 ft/s ²
Acceleration, self-supporting a_s max.	131.23 ft/s ²

Contact our engineering department to meet any higher requirements: efk@murrplastik.de

MATERIAL PROPERTIES

Standard material	Polyamide (PA) black
Service temperature	-22.00 – 248.00 °F
Gliding friction factor	0.30
Static friction factor	0.45
Fire classification	UL 94 HB

Other material properties on request

SHELVING SYSTEM

CHAIN BRACKET

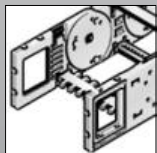

Chain bracket flexible

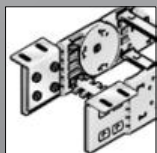

Chain bracket angle



Separator TR

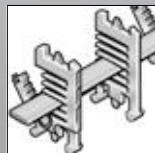

RS shelving system



Crossbar connector RSV

ACCESSORIES



Bracket bar



Lock button

GUIDE CHANNELS



VAW steel galvanized / stainless steel

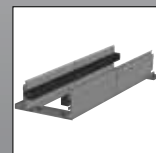

VAW aluminum

STRAIN RELIEF



RS-ZL crossbar strain relief



STF Steel Fix

ORDERING KEY

Type code	Variation	Inside width	Outside width	Inside width	Outside width	Radius	Rail variant	Material	Chain length
0621 30	Crossbar on outside bend Crossbar on inside bend Opens on inside and outside of bend	093 [3.66]	125 [4.92]	468 [18.43]	500 [19.69]	150 [5.91]	0 Plastic, full-ridged with bias	0 Polyamide (PA): standard (PA/black)	
		106 [4.17]	138 [5.43]	518 [20.39]	550 [21.65]				
		118 [4.65]	150 [5.91]			200 [7.87]	1 Plastic, full-ridged without bias	9 Special version (on request)	
		131 [5.16]	163 [6.42]						
		143 [5.63]	175 [6.89]			250 [9.84]	2 Plastic, half-ridged with bias		
		156 [6.14]	188 [7.40]						
		168 [6.61]	200 [7.87]			300 [11.81]	3 Plastic, half-ridged without bias		
		181 [7.13]	213 [8.39]						
		193 [7.60]	225 [8.86]			400 [15.75]	4 Aluminum full-ridged with bias		
		206 [8.11]	238 [9.37]						
		218 [8.58]	250 [9.84]			500 [19.69]	5 Aluminum full-ridged without bias		
		231 [9.09]	263 [10.35]						
		243 [9.57]	275 [10.83]				6 Aluminum half-ridged with bias		
		256 [10.08]	288 [11.34]						
		268 [10.55]	300 [11.81]				7 Aluminum half-ridged without bias		
		293 [11.54]	325 [12.80]						
		318 [12.52]	350 [13.78]				9 Special version (on request)		
		343 [13.50]	375 [14.76]						
		368 [14.49]	400 [15.75]						
		418 [16.46]	450 [17.72]						

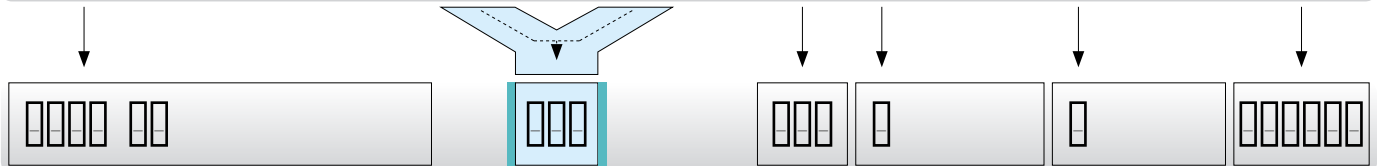

ORDERING EXAMPLE: 0623 118 150 0 0 000062

Crossbar on outside bend, crossbar on inside bend, can be opened from inside and outside bend
 Inside width 4.65 in.; radius 5.91 in.
 Plastic crossbar, full-ridged with bias, material black-colored polyamide
 Chain length 62 in. (16 links)

NOTE ON CONFIGURATION

Aluminum crossbars:

Aluminum crossbars in 0.04 in (1 mm) width sizes for inner widths from 2.83 inch – 23.62 inch are available for delivery.

Crossbar connector and crossbar strain relief plate:

Once inside widths exceed 9.69 inches (246 mm), we recommend the deployment of crossbar connectors (RSV). If crossbar strain relief plates (RS-ZL) are to be deployed in the chain brackets, take standard inside widths into account.

For detailed information, please consult the corresponding product documentation.

SELF-SUPPORTING LENGTH

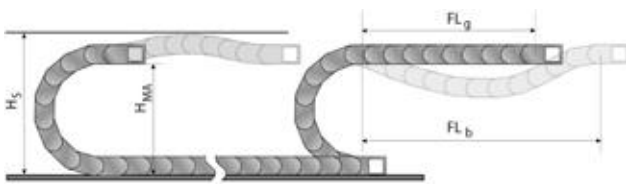

The self-supporting length is the distance between the chain bracket on the moving end and the start of the chain arch. The installation variant FL_g offers the lowest load and wear for the cable drag chain. The maximum travel parameters (speed and acceleration) can be applied for this variant.

- H_s = Installation height plus safety
- H_{MA} = Height of moving end connection
- FL_g = Self-supporting length, upper run straight
- FL_b = Self-supporting length, upper run bent

LOAD DIAGRAM FOR SELF-SUPPORTING APPLICATIONS

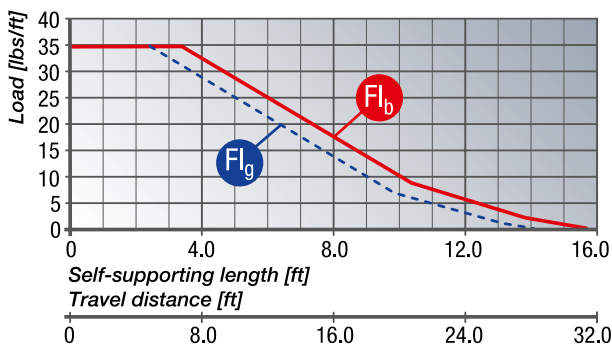

FL_g Self-supporting length, upper run straight

In the FL_g range, the chain upper run still has a bias, is straight or has a maximum sag of 3.15 inch.

FL_b Self-supporting length, upper run bent

In the FL_b range, the chain upper run has a sag of more than 3.15 inch, but this is still less than the maximum sag. Where the sag is greater than that permitted in the FL_b range, the application is critical and should be avoided. The self-supporting length can be optimized by using a support for the upper run or a more stable cable drag chain.

DETERMINING THE CHAIN LENGTH

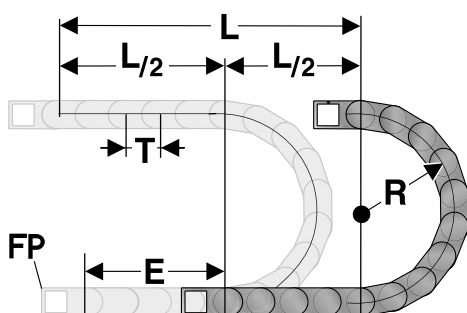

The fixed point of the cable drag chain should be connected in the middle of the travel distance.

This arrangement gives the shortest connection between the fixed point (FP) and the moving bracket and thus the most efficient chain length.

$$\text{Chain length calculation} = L/2 + \pi * R + E$$

$$\approx 1 \text{ ft chain} = 10 \text{ qty.} \times 3.94 \text{ inch.}$$

- E = Distance between entry point and middle of travel distance
- L = Travel distance
- R = Radius
- P = Grid 3.94 inch

INSTALLATION DIMENSIONS

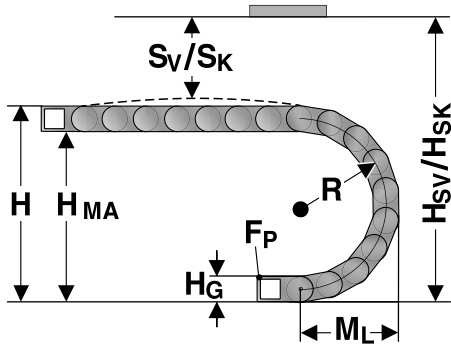

The moving end chain connection is to be screw fixed at height H_{MA} for the respective radius.

Concerning the installed dimensions, you must take into account whether the chain links are equipped with or without bias.

For chain links without bias, the “Installed height without bias H_{SK} ” value has to be taken into account.

If the chain links are equipped with a bias, the value “Installed height with bias H_{SV} ” has to be taken into account.

Radius R	5.91	7.87	9.84	11.81	15.75	19.69
Outside height of chain link (H_G)	3.70	3.70	3.70	3.70	3.70	3.70
Height of bend (H)	16.70	20.62	24.56	28.50	36.38	44.26
Height of moving end connection (H_{MA})	13.00	16.92	20.86	24.80	32.68	40.56
Safety margin with bias (S_V)	1.97	1.97	1.97	1.97	1.97	1.97
Installation height with bias (H_{SV})	18.67	22.59	26.53	30.47	38.35	46.23
Safety margin without bias (S_K)	0.79	0.79	0.79	0.79	0.79	0.79
Installation height without bias (H_{SK})	17.49	21.41	25.35	29.29	37.17	45.05
Arc projection (M_L)	12.29	14.25	16.22	18.19	22.13	26.07

HEAVYLINE PLASTIC CROSSBAR



The crossbars connect the two side runs of the cable drag chain. The crossbar length is synonymous with the inside width of the cable drag chain.

Type	Order No.	Description	Inside width inch
BS 093-7	072009300000	Crossbar	3.66
BS 106-7	072010600000	Crossbar	4.17
BS 118-7	072011800000	Crossbar	4.65
BS 131-7	072013100000	Crossbar	5.16
BS 143-7	072014300000	Crossbar	5.63
BS 156-7	072015600000	Crossbar	6.14
BS 168-7	072016800000	Crossbar	6.61
BS 181-7	072018100000	Crossbar	7.13
BS 193-7	072019300000	Crossbar	7.60
BS 206-7	072020600000	Crossbar	8.11
BS 231-7	072023100000	Crossbar	9.09
BS 243-7	072024300000	Crossbar	9.57
BS 256-7	072025600000	Crossbar	10.08
BS 268-7	072026800000	Crossbar	10.55

HEAVYLINE PLASTIC CROSSBAR

Type	Order No.	Description	Inside width inch
BS 293-7	072029300000	Crossbar	11.54
BS 318-7	072031800000	Crossbar	12.52
BS 343-7	072034300000	Crossbar	13.50
BS 368-7	072036800000	Crossbar	14.49
BS 418-7	072041800000	Crossbar	16.46
BS 468-7	072046800000	Crossbar	18.43
BS 518-7	072051800000	Crossbar	20.39

CHAIN BRACKET KA 62.1

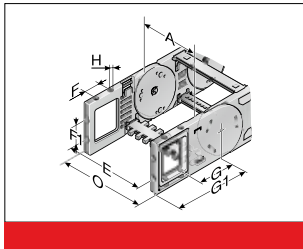

This chain bracket offers universal connection options (top, bottom and front) and is attached to the ends of the chain like a side link. This allows the chain to move right up to the bracket. Each chain requires one male and one female bracket. M8 screws are used to secure the brackets in place. Extrusion-coated metal bushes with either a through-hole (-FB) or a threaded hole (-FG) ensure the permanent, high-strength transmission of even extreme forces onto the cable drag chain.

Type	Order No.	Material	Version	Inside width							Outside width of KA O inch
				A inch	E inch	F inch	F1 inch	G inch	G1 inch	H inch	
KA 62-FB Female end	0620000056	Plastic	with bush	3.66 – 20.39	A+0.67	1.38	1.77	4.21	6.75	0.33	A+1.42
KA 62-FB male end	0620000057	Plastic	with bush	3.66 – 20.39	A+0.67	1.38	1.77	4.21	6.75	0.33	A+1.42
KA 62-FG Female end	0620000058	Plastic	with thread	3.66 – 20.39	A+0.67	1.38	1.77	4.21	6.75	M8	A+1.42
KA 62-FG male end	0620000059	Plastic	with thread	3.66 – 20.39	A+0.67	1.38	1.77	4.21	6.75	M8	A+1.42

KA 62.1 CHAIN BRACKET ANGLE

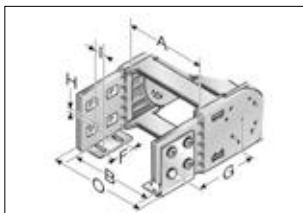

KA 62 (inside top / bottom)

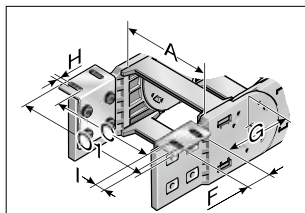

KA 62 (outside top / bottom)

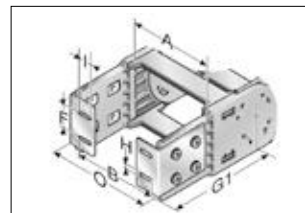

KA 62 (front inside)

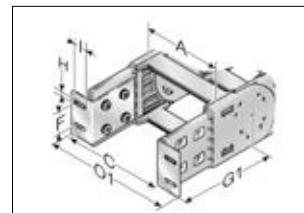

KA 62 (front outside)

This chain bracket offers universal connection options (top, bottom and front) and is attached to the ends of the chain like a side link. This allows the chain to move right up to the bracket. Each chain requires one male and one female bracket. M8

screws are used to secure the brackets in place. Metal inserts (supplied) help to minimize the cold flow properties. This is an enormous advantage, guaranteeing the smooth transfer of high loads to the chain.

Type	Order No.	Material	Inside width							Outside width of KA O inch	Outside width of KA O1 inch	
			A inch	B inch	C inch	F inch	G inch	G1 inch	HØ inch			I inch
KA 62 Female end	0620000050	Sheet steel	3.66 – 20.39	A-0.47	A+1.73	1.77	4.02	6.75	0.35	0.59	A+1.26	A+3.54
KA 62 Male end	0620000051	Sheet steel	3.66 – 20.39	A-0.47	A+1.73	1.77	4.02	6.75	0.35	0.59	A+1.26	A+3.54

MP 62 SEPARATOR

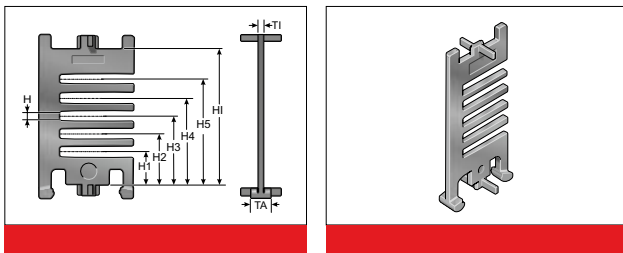

We recommend that separators be used if multiple round cables or conduits with differing diameters are to be installed.

Type	Order No.	Description	Version	TI inch	TA inch	H inch	H1 inch	H2 inch	H3 inch	H4 inch	H5 inch	Hl inch
TR 62	062000009200	Separator	lockable	0.14	0.51	0.22	0.58	0.91	1.24	1.56	1.89	2.44

RTT 62 SHELF SUPPORT, DIVISIBLE

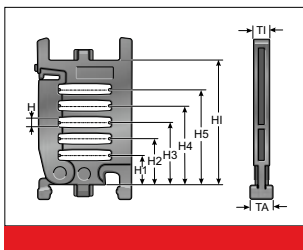

In connection with two separable shelf supports (RTT) with at least one end-to-end shelf (RB) the shelf becomes an easy to fill shelving system. The additional levels prevent cables from criss-crossing and minimize the friction between them.

Type	Order No.	Description	Version	TI inch	TA inch	H inch	H1 inch	H2 inch	H3 inch	H4 inch	H5 inch	Hl inch
RTT 62	100090622000	Shelf support, divisible	lockable	0.31	0.31	0.22	0.58	0.91	1.24	1.56	1.89	2.44

RB-7 SHELF

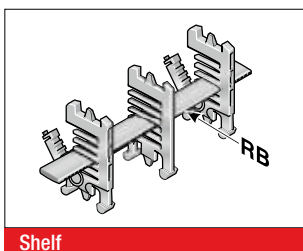

In connection with at least two separable shelf supports (RTT), the shelf becomes a shelving system. The additional levels prevent cables from criss-crossing and minimize the friction between them.

Type	Order No.	Description	Width inch	Inside width inch
RB 056-7	100000005600	Shelf	2.20	3.66
RB 061-7	1000006107	Shelf	2.40	3.66
RB 066-7	100000006600	Shelf	2.60	3.66
RB 071-7	1000007107	Shelf	2.80	3.66
RB 076-7	1000007607	Shelf	2.99	3.66
RB 081-7	10000008100	Shelf	3.19	3.66
RB 086-7	1000008607	Shelf	3.39	3.66
RB 091-7	1000009107	Shelf	3.58	4.17
RB 096-7	1000009607	Shelf	3.78	4.17
RB 101-7	1000010107	Shelf	3.98	4.17
RB 106-7	100000010600	Shelf	4.17	4.17
RB 111-7	1000011107	Shelf	4.37	4.65
RB 116-7	100000011600	Shelf	4.57	4.65
RB 121-7	1000012107	Shelf	4.76	5.16
RB 126-7	1000012607	Shelf	4.96	5.16

RB-7 SHELF

Type	Order No.	Description	Width inch	Inside width inch
RB 131-7	1000013107	Shelf	5.16	5.63
RB 136-7	1000013607	Shelf	5.35	5.63
RB 141-7	1000014107	Shelf	5.55	5.63
RB 146-7	1000014607	Shelf	5.75	6.14
RB 151-7	1000015107	Shelf	5.94	6.14
RB 156-7	1000015607	Shelf	6.14	6.14
RB 161-7	1000016107	Shelf	6.34	6.61
RB 166-7	100000016600	Shelf	6.54	6.61
RB 171-7	1000017107	Shelf	6.73	7.13
RB 176-7	1000017607	Shelf	6.93	7.13
RB 181-7	1000018107	Shelf	7.13	7.60
RB 186-7	1000018607	Shelf	7.32	7.60
RB 191-7	1000019107	Shelf	7.52	7.60
RB 196-7	1000019607	Shelf	7.72	8.11
RB 201-7	1000020107	Shelf	7.91	8.11
RB 206-7	1000020607	Shelf	8.11	8.11
RB 211-7	1000021107	Shelf	8.31	8.58
RB 216-7	100000021600	Shelf	8.50	8.58

MP 62 CROSSBAR CONNECTOR



For crossbars wider than 9.69 inch (246 mm), we recommend the use of crossbar connectors. These prevent deformation to the crossbar under large amounts of additional weight of the chain assembly.

Type	Order No.	Description	TI inch
RSV 62	062000009600	Crossbar connector	0.31
RSV 62 Alu	062000009800	Crossbar connector for aluminum crossbars	0.31

BS-5 BRACKET BAR



Large-diameter conduits are routed securely by using bracket bars (BS). This bar is installed on the crossbars or the covers of the cable drag chain. The bracket bar can be installed on both the inside and outside bend.

The bracket bar support (BSH) is used to attach the bars to PowerLine series crossbars. Two bracket bar supports are required for each bar.

Type	Order No.	Description	Conduit diameter max. inch	Installation height inch	Inner chain width min. inch
BS 120-5	052412000000	Bracket bar	4.53	5.51	6.46
BS 153-5	052415300000	Bracket bar	5.83	6.69	8.19
BS 187-5	052418700000	Bracket bar	7.17	8.07	9.17
Assembly set	052400000001	Assembly set			

RS-ZL-7 CROSSBAR STRAIN RELIEF PLATE

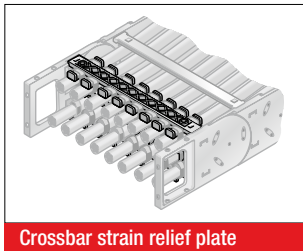

Fixed integrated crossbar strain relief plates in the chain brackets. Accommodated to all widths of the frame ridges, up to 10.08 inch in size. May be assembled on the inside and outside bends at both chain endings.

Type	Order No.	Description	Inside width inch
RS-ZL 093-7	072009300010	Crossbar strain relief plate	3.66
RS-ZL 106-7	072010600010	Crossbar strain relief plate	4.17
RS-ZL 118-7	072011800010	Crossbar strain relief plate	4.65
RS-ZL 131-7	072013100010	Crossbar strain relief plate	5.16
RS-ZL 143-7	072014300010	Crossbar strain relief plate	5.63
RS-ZL 156-7	072015600010	Crossbar strain relief plate	6.14
RS-ZL 168-7	072016800010	Crossbar strain relief plate	6.61
RS-ZL 181-7	072018100010	Crossbar strain relief plate	7.13
RS-ZL 193-7	072019300010	Crossbar strain relief plate	7.60
RS-ZL 206-7	072020600010	Crossbar strain relief plate	8.11
RS-ZL 218-7	072021800010	Crossbar strain relief plate	8.58
RS-ZL 231-7	072023100010	Crossbar strain relief plate	9.09
RS-ZL 243-7	072024300010	Crossbar strain relief plate	9.57
RS-ZL 256-7	072025600010	Crossbar strain relief plate	10.08

MP 52/62/72 LOCK BUTTON

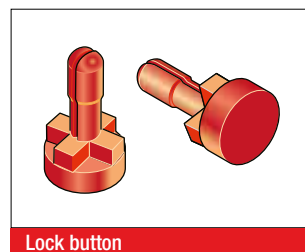
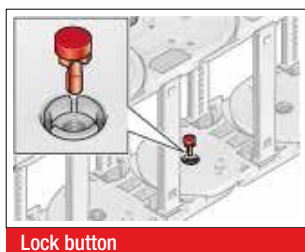
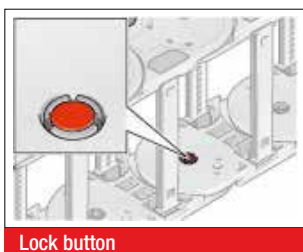

To increase the side stability we recommend the use of lock buttons during strong lateral acceleration or when installed “laying

on the side (turned 90°) without support”.

Type	Order No.
MP52/62/72 lock button	0520000080

STRAIN RELIEF WITH STEEL FIX

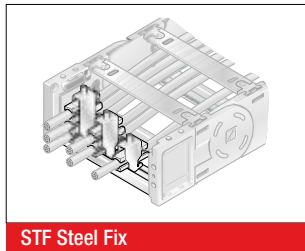
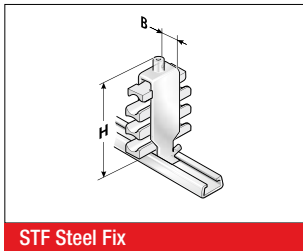

C-rails (galvanized) for permanent integration, for accommodating the Steel Fix bow clamps in the chain brackets. The bow clamps can take up to 3 cables and are suitable for C-rails with a groove width of 0.43 in (11 mm). Due to the design of the trough elements, a cable preserving cable guidance is ensured. May be assembled on the inside and outside bends at both chain endings. The overall height stated is a guide only. The actual height is, amongst other things, dependent on the diameter and the quality of the cable. A safety distance of 0.39 in (10 mm) at the fixed point above the strain relief must be kept during gliding applications.

Type	Order No.	Description	Seats qty.	Cable Ø inch	Width (B) inch	Total height (H) inch
Single clamp (for one cable)						
STF 12-1 Steel Fix	81661801	Hooped clamp	1	0.24 – 0.47	0.63	2.17
STF 14-1 Steel Fix	81661802	Hooped clamp	1	0.47 – 0.55	0.71	2.05
STF 16-1 Steel Fix	81661803	Hooped clamp	1	0.55 – 0.63	0.79	2.13
STF 18-1 Steel Fix	81661804	Hooped clamp	1	0.63 – 0.71	0.87	2.20
STF 20-1 Steel Fix	81661805	Hooped clamp	1	0.71 – 0.79	0.94	2.32
STF 22-1 Steel Fix	81661806	Hooped clamp	1	0.79 – 0.87	1.02	2.40
STF 26-1 Steel Fix	81661807	Hooped clamp	1	0.87 – 1.02	1.18	2.76
STF 30-1 Steel Fix	81661808	Hooped clamp	1	1.02 – 1.18	1.34	2.91
STF 34-1 Steel Fix	81661809	Hooped clamp	1	1.18 – 1.34	1.50	3.07
STF 38-1 Steel Fix	81661810	Hooped clamp	1	1.34 – 1.50	1.65	3.23
STF 42-1 Steel Fix	81661811	Hooped clamp	1	1.50 – 1.65	1.81	3.58
Double clamp (for two cables)						
STF 12-2 Steel Fix	81661821	Hooped clamp	2	0.24 – 0.47	0.63	2.87
STF 14-2 Steel Fix	81661822	Hooped clamp	2	0.47 – 0.55	0.71	2.91
STF 16-2 Steel Fix	81661823	Hooped clamp	2	0.55 – 0.63	0.79	3.23
STF 18-2 Steel Fix	81661824	Hooped clamp	2	0.63 – 0.71	0.87	3.39
STF 20-2 Steel Fix	81661825	Hooped clamp	2	0.71 – 0.79	0.94	3.58
STF 22-2 Steel Fix	81661826	Hooped clamp	2	0.79 – 0.87	1.02	3.74
STF 26-2 Steel Fix	81661827	Hooped clamp	2	0.87 – 1.02	1.18	4.25
STF 30-2 Steel Fix	81661828	Hooped clamp	2	1.02 – 1.18	1.34	4.76
STF 34-2 Steel Fix	81661829	Hooped clamp	2	1.18 – 1.34	1.50	5.08
Triple clamp (for three cables)						
STF 12-3 Steel Fix	81661841	Hooped clamp	3	0.24 – 0.47	0.63	3.86
STF 14-3 Steel Fix	81661842	Hooped clamp	3	0.47 – 0.55	0.71	3.86
STF 16-3 Steel Fix	81661843	Hooped clamp	3	0.55 – 0.63	0.79	4.13
STF 18-3 Steel Fix	81661844	Hooped clamp	3	0.63 – 0.71	0.87	4.37
STF 20-3 Steel Fix	81661845	Hooped clamp	3	0.71 – 0.79	0.94	4.65
STF 22-3 Steel Fix	81661846	Hooped clamp	3	0.79 – 0.87	1.02	5.12

LOWERED FIXING POINT MP 62

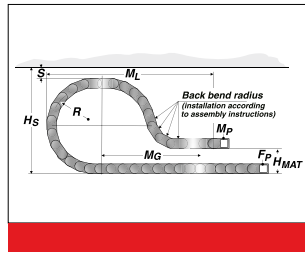
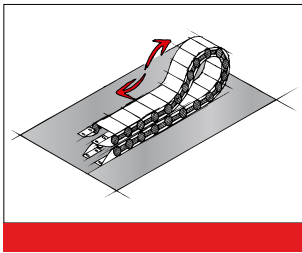

It is sometimes necessary to lower the height of the moving attachment point.

In such cases, modifications to the chain layout should be noted (e.g. extension of chain).

Please contact our application engineers.

Radius R inch	Height of moving end connection (H _{MA}) inch	Safety margin (S) inch	Installation height incl. safety (H _S) inch	Projection (M _L) inch	Additional links qty.	of which additional back chain links qty.
7.87	9.06	2.36	22.20	33.46	11	2
9.84	10.63	2.36	26.14	38.98	12	2
11.81	12.60	2.36	30.08	41.73	12	3
15.75	14.96	3.54	27.32	41.73	14	3
19.69	17.32	2.36	45.83	59.84	17	3

MP 62.1 REARWARD RADII

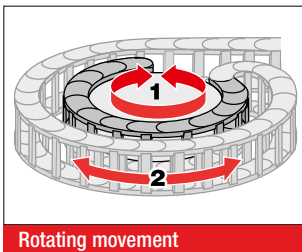

Rotating movement

Side links with forward radius (R) and rearward radius (R_Ü) allow movements in both directions. This is intended for rotating movements and lowered chain brackets. Note: This type of chain has different chain links for the left or right side! Rotation movements are only possible with open variants.

Type	Order No.	Radius inch	Back radius inch
SR 62.1 (RÜ300/R300) left	062100030060	11.81	11.81
SR 62.1 (RÜ300/R300) right	062100030062	11.81	11.81

GUIDE CHANNEL VAW (ALUMINUM / STAINLESS STEEL)



VAW steel galvanized / stainless steel



VAW aluminum

A range of variable guide channel systems, constructed from aluminum or stainless steel sections, is available for this cable drag chain.

The variable guide channel ensures that the cable drag chain is supported and guided securely.

ASSEMBLY INSTRUCTION FLEXIBLE CHAIN BRACKET FB/FG

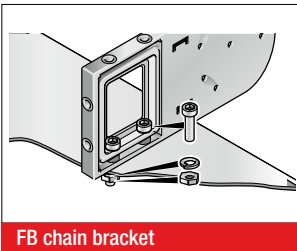

FB chain bracket

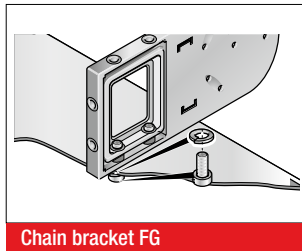

Chain bracket FG

Brass bushes guarantee long-lasting fastening without cold flow in the plastic.

Version KA-FB:

Integrated through-hole fastened down using nut and bolt.

Version KA-FG:

Built-in threads allow for quick and easy on-site mounting, since a screw, including a retaining washer where necessary, is sufficient.

ASSEMBLY

DISASSEMBLY

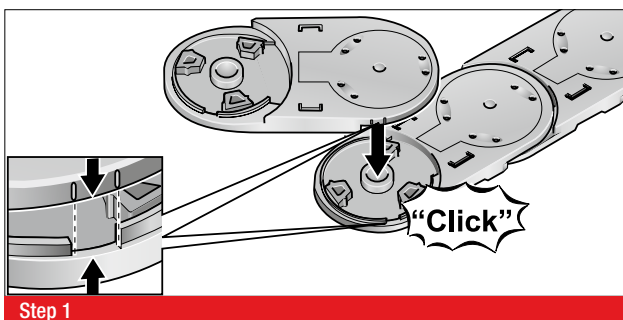

Step 1

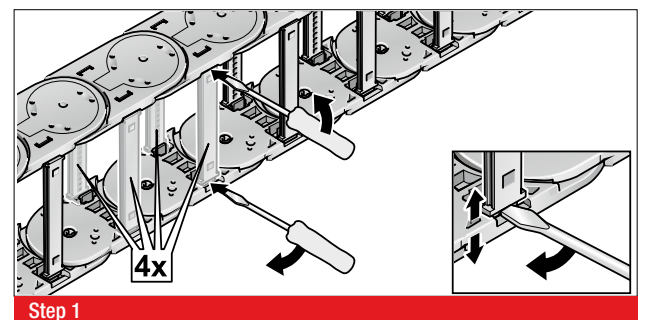

Step 1

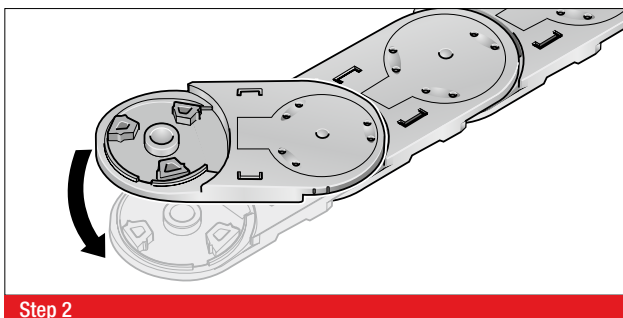

Step 2

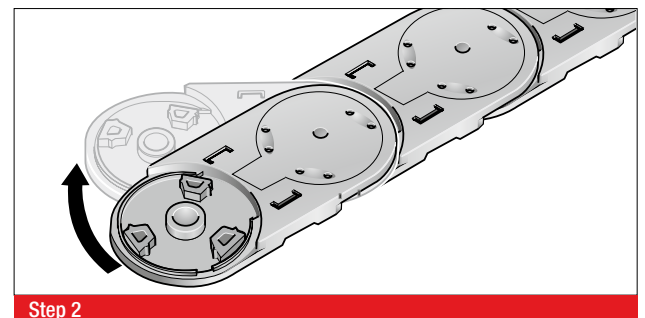

Step 2

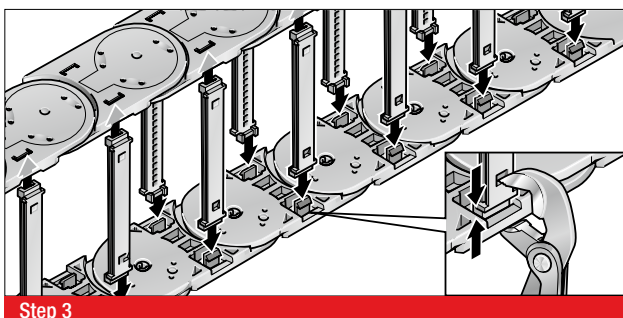

Step 3

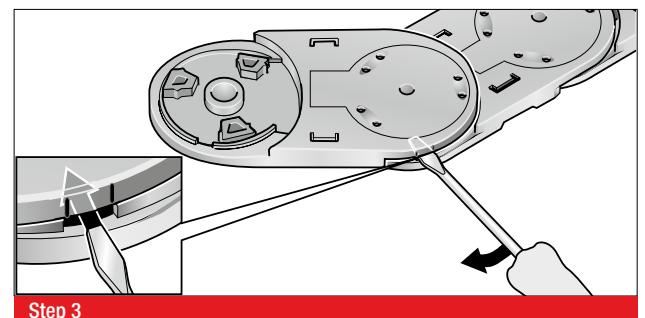

Step 3

MP 66 OPEN



- PLASTIC OR ALUMINUM VERSION
- METAL CHAIN BRACKET
- OPENS ON INSIDE AND OUTSIDE OF BEND

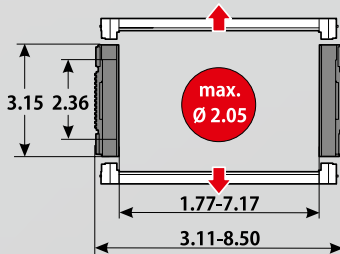

TECHNICAL DATA

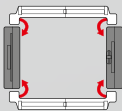

Loading side
Inside and outside bend

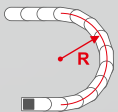

Available radii
5.91 – 15.75 inch

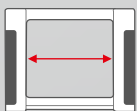

Available interior widths
With plastic crossbar
1.77 – 7.17 inch
With aluminum crossbar / cover
3.03 – 23.62 inch /

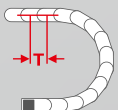

Grid
T = 3.60 inch





TECHNICAL SPECIFICATIONS

Travel distance gliding L_g max.	196.85 ft.
Travel distance self-supporting L_s max.	see diagram on page 403
Travel distance vertical, hanging L_{vh} max.	164.04 ft.
Travel distance vertical, upright L_{vs} max.	16.40 ft.
Rotated 90°, unsupported L_{90f} max.	6.56 ft.
Speed, gliding V_g max.	16.40 ft/s
Speed, self-supporting V_f max.	49.21 ft/s
Acceleration, gliding a_g max.	49.21 ft/s ²
Acceleration, self-supporting a_s max.	65.62 ft/s ²

Contact our engineering department to meet any higher requirements: efk@murrplastik.de

MATERIAL PROPERTIES

Standard material	Polyamide (PA) black
Service temperature	-22.00 – 248.00 °F
Gliding friction factor	0.30
Static friction factor	0.45
Fire classification	Based on UL 94 HB

Other material properties on request

CHAIN BRACKET

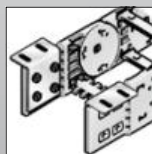

Chain bracket angle

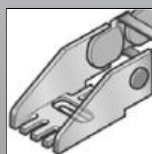

Chain bracket U-part

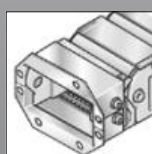

Chain bracket flange

SHELVING SYSTEM

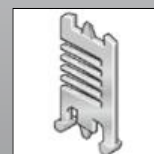

Separator TR

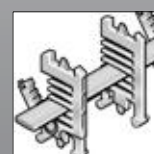

RS shelving system

GUIDE CHANNELS

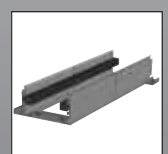

VAW aluminum

ORDERING KEY

Type code	Variation	Inside width	Outside width	Inside width	Outside width	Radius	Rail variant	Material	Chain length
0660 30	Crossbar on outside bend Crossbar on inside bend Opens on inside and outside of bend	045 <small>[1.77]</small>	079 <small>[3.11]</small>			150 <small>[5.91]</small>	0 Plastic, full-ridged with bias	0 Polyamide (PA): standard (PA/black)	
		062 <small>[2.44]</small>	096 <small>[3.78]</small>						
		084 <small>[3.31]</small>	118 <small>[4.65]</small>			200 <small>[7.87]</small>	1 Plastic, full-ridged without bias	9 Special version (on request)	
		105 <small>[4.13]</small>	139 <small>[5.47]</small>						
		144 <small>[5.67]</small>	178 <small>[7.01]</small>			240 <small>[9.45]</small>	2 Plastic, half-ridged with bias		
		182 <small>[7.17]</small>	216 <small>[8.50]</small>						
						280 <small>[11.02]</small>	3 Plastic, half-ridged without bias		
						350 <small>[13.78]</small>	4 Aluminum full-ridged with bias		
						400 <small>[15.75]</small>	5 Aluminum full-ridged without bias		
							6 Aluminum half-ridged with bias		
							7 Aluminum half-ridged without bias		
							9 Special version (on request)		

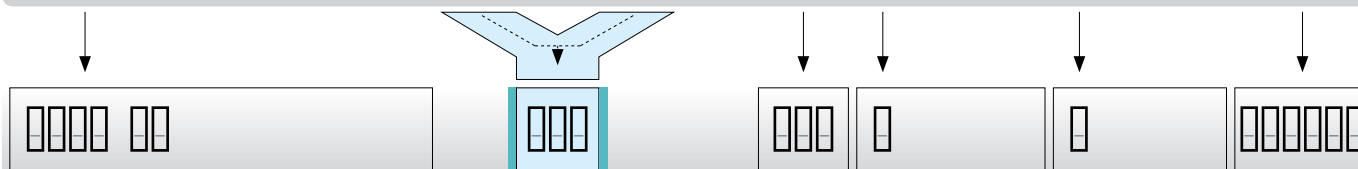

ORDERING EXAMPLE: 0660 045 150 0 0 000061

Crossbar on outside bend, crossbar on inside bend, can be opened from inside and outside bend
 Inside width 1.77 in.; radius 5.91 in.
 Plastic crossbar, full-ridged with bias, material black-colored polyamide
 Chain length 61 in. (17 links)

NOTE ON CONFIGURATION

Aluminum crossbars:

Aluminum crossbars in 0.04 in (1 mm) width sizes for inner widths from 3.03 inch – 23.62 inch are available for delivery.

Strain relief:

The end brackets utilize strain relief plates (ZL) for cable strain relief.

For detailed information, please consult the corresponding product documentation.

SELF-SUPPORTING LENGTH

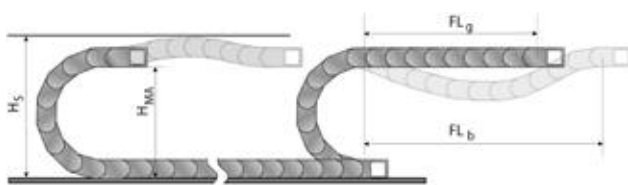

The self-supporting length is the distance between the chain bracket on the moving end and the start of the chain arch. The installation variant FL_g offers the lowest load and wear for the cable drag chain. The maximum travel parameters (speed and acceleration) can be applied for this variant.

- H_s = Installation height plus safety
- H_{MA} = Height of moving end connection
- FL_g = Self-supporting length, upper run straight
- FL_b = Self-supporting length, upper run bent

LOAD DIAGRAM FOR SELF-SUPPORTING APPLICATIONS

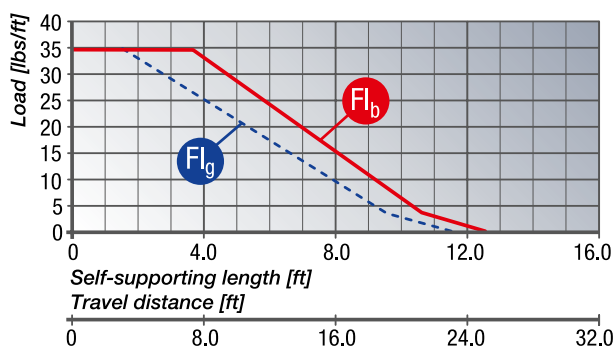

FL_g Self-supporting length, upper run straight
 In the FL_g range, the chain upper run still has a bias, is straight or has a maximum sag of 2.36 inch.

FL_b Self-supporting length, upper run bent
 In the FL_b range, the chain upper run has a sag of more than 2.36 inch, but this is still less than the maximum sag. Where the sag is greater than that permitted in the FL_b range, the application is critical and should be avoided. The self-supporting length can be optimized by using a support for the upper run or a more stable cable drag chain.

DETERMINING THE CHAIN LENGTH

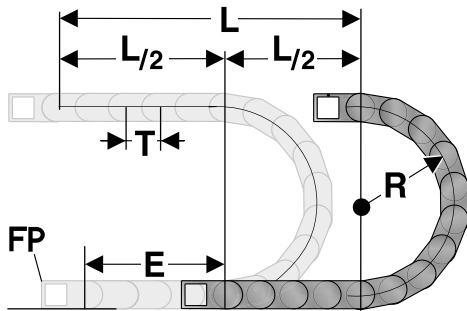

The fixed point of the cable drag chain should be connected in the middle of the travel distance.

This arrangement gives the shortest connection between the fixed point (FP) and the moving bracket and thus the most efficient chain length.

Chain length calculation = $L/2 + \pi * R + E$
 $\approx 1 \text{ ft chain} = 11 \text{ qty.} \times 3.60 \text{ inch.}$

E = Distance between entry point and middle of travel distance

L = Travel distance

R = Radius

P = Grid 3.60 inch

INSTALLATION DIMENSIONS

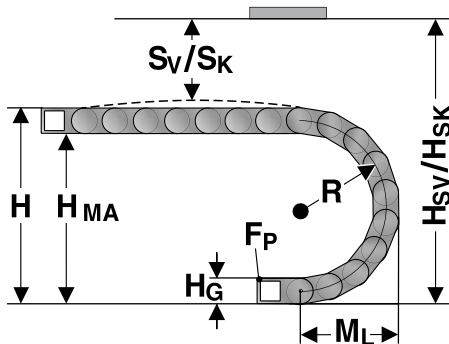

The moving end chain connection is to be screw fixed at height H_{MA} for the respective radius.

Concerning the installed dimensions, you must take into account whether the chain links are equipped with or without bias.

For chain links without bias, the "Installed height without bias H_{sk}" value has to be taken into account.

If the chain links are equipped with a bias, the value "Installed height with bias H_{sv}" has to be taken into account.

Radius R	5.91	7.87	9.45	11.02	13.78	15.75
Outside height of chain link (H _G)	3.15	3.15	3.15	3.15	3.15	3.15
Height of bend (H)	14.97	18.89	22.05	25.19	30.71	34.65
Height of moving end connection (H _{MA})	11.82	15.74	18.90	22.04	27.56	31.50
Safety margin with bias (S _v)	1.97	1.97	1.97	1.97	1.97	1.97
Installation height with bias (H _{sv})	16.94	20.86	24.02	27.16	32.68	36.62
Safety margin without bias (S _k)	0.59	0.59	0.59	0.59	0.59	0.59
Installation height without bias (H _{sk})	15.56	19.48	22.64	25.78	31.30	35.24
Arc projection (M _L)	11.09	13.05	14.62	16.20	18.95	20.93

KA 66 CHAIN BRACKET ANGLE

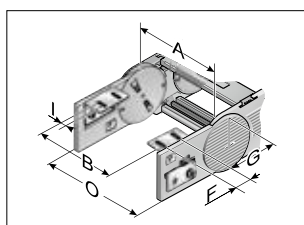

KA 66 (inside top / bottom)

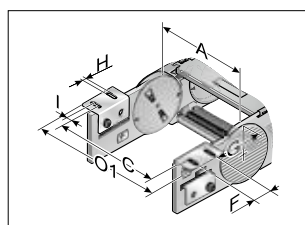

KA 66 (outside top / bottom)

There are several options regarding the chain bracket. The fixed-point bracket (inside/bottom) and the moving end bracket (inside/top) are supplied as standard. However, any other combination can be supplied upon request. The chain bracket is fastened at the end like a side link. This enables the chain to move right up to the bracket. Each chain requires two chain brackets. The brackets should be fastened with M8 screws.

Type	Order No.	Material	Inside width							Outside width of KA 0 inch	Outside width of KA 01 inch	
			A inch	B inch	C inch	F inch	G inch	G1 inch	HØ inch			I inch
KA 66	0660000050	Sheet steel	2.44 – 7.17	A-0.67	A+2.01	1.77	1.99	3.39	0.35	0.39	A+1.34	A+2.52
KA 66	0660000060	Stainless steel 1.4301	2.44 – 7.17	A-0.67	A+2.01	1.77	1.99	3.39	0.35	0.39	A+1.34	A+2.52

KA 66 CHAIN BRACKET U-PART

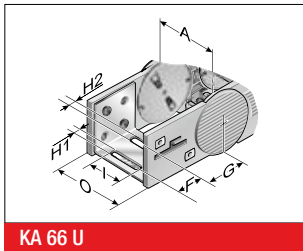

The chain bracket is an all-plastic part. The bracket is precisely adjusted to the respective chain width and only needs to be snapped in at the chain link. Please order one male and one female end bracket for each chain. The brackets should be fastened with M5 screws. The cables or conduits may be fastened with cable ties on the integrated strain relief of the chain bracket.

KA 66 U

Type	Order No.	Material	Inside width						Outside width of KA 0 inch
			A inch	F inch	G inch	H1 inch	H2 inch	I inch	
KA 66 U	0660000054	Sheet steel	1.77	1.10	2.30	0.26	0.33	1.30	A+1.34

KA 65 CHAIN BRACKET FLANGE

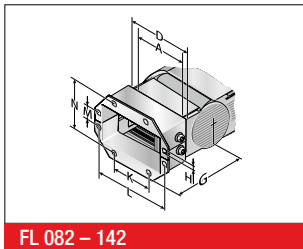

A cable drag chain requires two chain brackets. The divisible flange connection has been specifically designed for commissioning and re-installation. This keeps the chain in the installed position.

FL 082 – 142

Type	Order No.	Material	Inside width						
			A inch	G inch	HØ inch	K inch	L inch	M inch	N inch
FL 082	0650000070	Sheet steel	3.39	5.35	0.28	3.07	5.57	1.57	4.13
FL 107	0650000072	Sheet steel	4.02	5.35	0.28	3.94	6.44	1.57	4.13
FL 142	0650000074	Sheet steel	4.92	5.35	0.28	5.43	7.93	1.57	4.13
FL 082	0650000080	Stainless steel 1.4301	3.39	5.35	0.28	3.07	5.57	1.57	4.13
FL 107	0650000082	Stainless steel 1.4301	4.02	5.35	0.28	3.94	6.44	1.57	4.13
FL 142	0650000084	Stainless steel 1.4301	4.92	5.35	0.28	5.43	7.93	1.57	4.13

MP 66 SEPARATOR

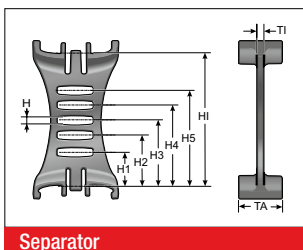

We recommend that separators be used if multiple round cables or conduits with differing diameters are to be installed.

Separator

Type	Order No.	Description	Version	Dimensions								
				TI inch	TA inch	H inch	H1 inch	H2 inch	H3 inch	H4 inch	H5 inch	H1 inch
TV 66	066000009000	Separator	lockable	0.14	0.79	0.17	0.62	0.90	1.18	1.46	1.74	2.36

SHELVING SYSTEM MP 66

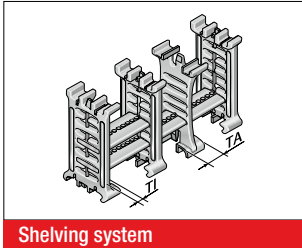

The shelf must be used with a minimum of two shelf supports to create a shelving system. The additional levels prevent cables from criss-crossing and minimize the friction between them. The shelving system may be preassembled on request.

Shelving system

Type	Order No.	Description	Width inch	Clearance width inch	Lock grid spacing inch	T1 inch	H1 inch	H2 inch	H3 inch	H4 inch	H5 inch	H6 inch	H7 inch
RB 031	100000003100	Shelf	1.65	1.22	0.06								
RB 048	100000004800	Shelf	2.32	1.89	0.06								
RB 070	100000007000	Shelf	3.19	2.76	0.06								
RB 092	100000009200	Shelf	4.06	3.62	0.06								
RB 100	100000010000	Shelf	4.37	3.94	0.06								
RB 128	100000012800	Shelf	5.47	5.04	0.06								
RB 167	100000016700	Shelf	7.01	6.57	0.06								
RT 66	1000900100	Shelf support	0.17		0.06	0.26	0.34	0.62	0.90	1.18	1.46	1.74	2.02

MP 66 REARWARD RADII

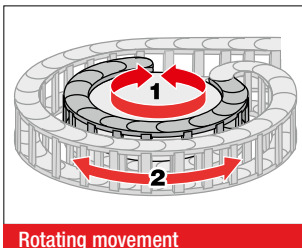

Side links with forward radius (R) and rearward radius (Rü) allow movements in both directions. This is intended for rotating movements and lowered chain brackets. Rotation movements are only possible with open variants.

Rotating movement

Type	Order No.	Back radius inch	Version
SR 66 (RÜ240)	066000000060	9.45	Available for radii 5.91, 7.87, 9.45, 11.02 and 13.78 in

VAW GUIDE CHANNEL



A variable guide channel system, constructed from aluminum sections, is available for this cable drag chain. The variable guide channel ensures that the cable drag chain is supported and guided securely.

VAW aluminum

ASSEMBLY

DISASSEMBLY

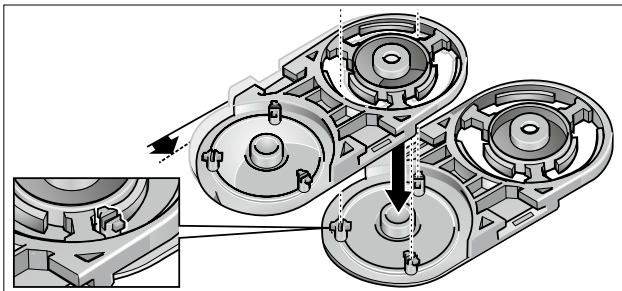

Step 1

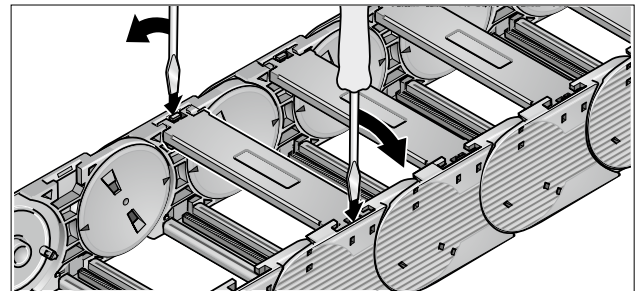

Step 1

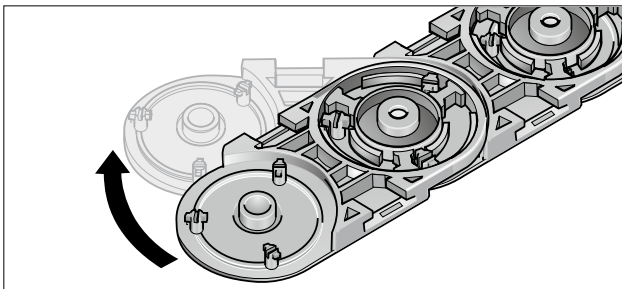

Step 2

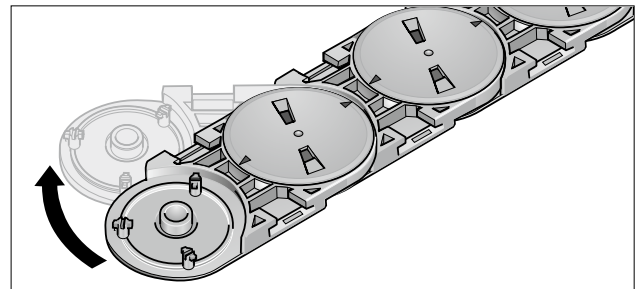

Step 2

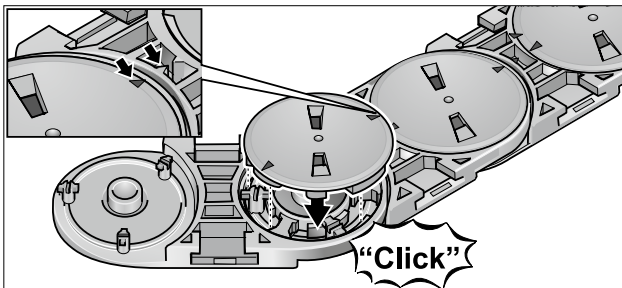

Step 3

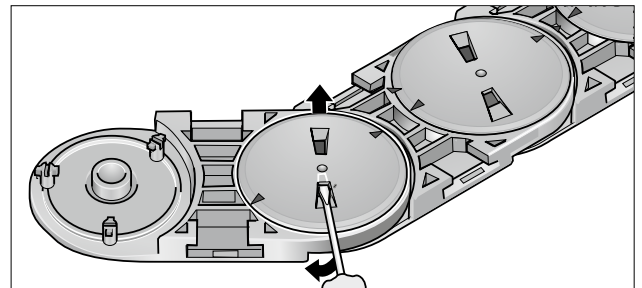

Step 3

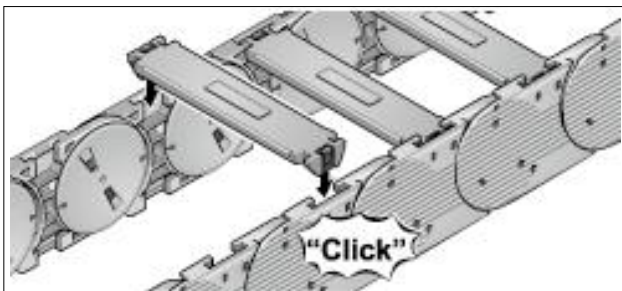

Step 4

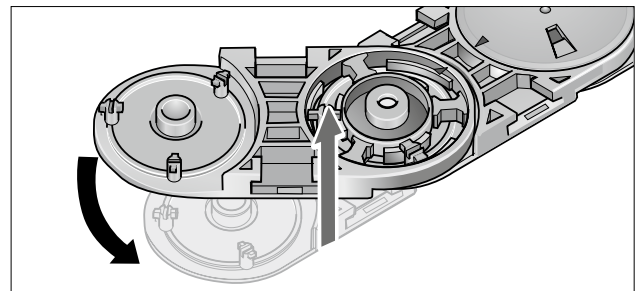

Step 4

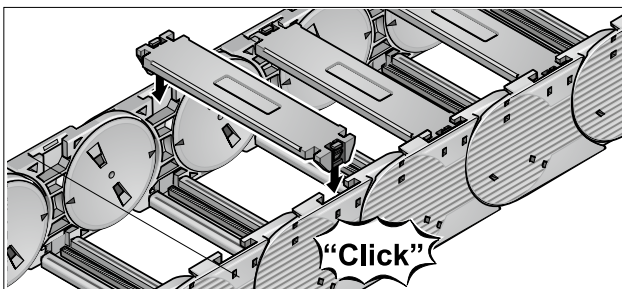

Step 5

MP 72 OPEN



- PLASTIC OR ALUMINUM VERSION
- CHAIN BRACKET FLEXIBLE

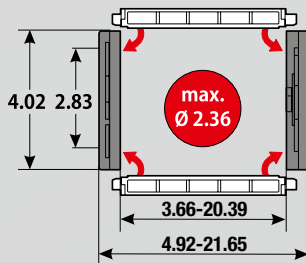

TECHNICAL DATA

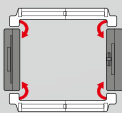

Loading side
Inside and outside bend

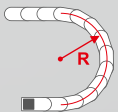

Available radii
5.91 – 19.69 inch

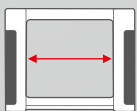

Available interior widths
With plastic crossbar
3.66 – 20.39 inch
With aluminum crossbar / cover
2.83 – 23.62 inch /

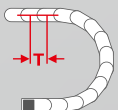

Grid
T = 3.94 inch





TECHNICAL SPECIFICATIONS

Travel distance gliding L_g max.	492.13 ft.
Travel distance self-supporting L_s max.	see diagram on page 411
Travel distance vertical, hanging L_{vh} max.	262.47 ft.
Travel distance vertical, upright L_{vs} max.	19.69 ft.
Rotated 90°, unsupported L_{90f} max.	19.69 ft.
Speed, gliding V_g max.	16.40 ft/s
Speed, self-supporting V_f max.	65.62 ft/s
Acceleration, gliding a_g max.	82.02 ft/s ²
Acceleration, self-supporting a_f max.	131.23 ft/s ²

Contact our engineering department to meet any higher requirements: efk@murrplastik.de

MATERIAL PROPERTIES

Standard material	Polyamide (PA) black
Service temperature	-22.00 – 248.00 °F
Gliding friction factor	0.30
Static friction factor	0.45
Fire classification	UL 94 HB

Other material properties on request

SHELVING SYSTEM



Separator TR

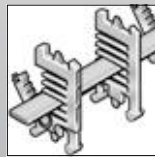

RS shelving system

CHAIN BRACKET

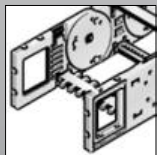

Chain bracket flexible



Crossbar connector RSV

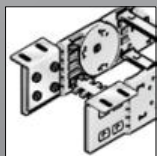

Chain bracket angle

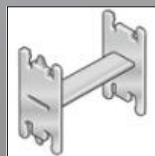

H-shaped shelf unit RE

ACCESSORIES

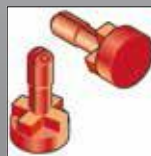

Lock button

GUIDE CHANNELS



VAW steel galvanized / stainless steel

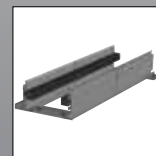

VAW aluminum

STRAIN RELIEF



RS-ZL crossbar strain relief



STF Steel Fix

ORDERING KEY

Type code	Variation	Inside width	Outside width	Inside width	Outside width	Radius	Rail variant	Material	Chain length
0720 30	Crossbar on outside bend Crossbar on inside bend Opens on inside and outside of bend	093 [3.66]	125 [4.92]	468 [18.43]	500 [19.69]	150 [5.91]	0 Plastic, full-ridged with bias	0 Polyamide (PA): standard (PA/black)	
		106 [4.17]	138 [5.43]	518 [20.39]	550 [21.65]				
		118 [4.65]	150 [5.91]			200 [7.87]	2 Plastic, half-ridged with bias	9 Special version (on request)	
		131 [5.16]	163 [6.42]						
		143 [5.63]	175 [6.89]			250 [9.84]	4 Aluminum full-ridged with bias		
		156 [6.14]	188 [7.40]						
		168 [6.61]	200 [7.87]			300 [11.81]	6 Aluminum half-ridged with bias		
		181 [7.13]	213 [8.39]						
		193 [7.60]	225 [8.86]			400 [15.75]	9 Special version (on request)		
		206 [8.11]	238 [9.37]						
		218 [8.58]	250 [9.84]			500 [19.69]			
		231 [9.09]	263 [10.35]						
		243 [9.57]	275 [10.83]						
		256 [10.08]	288 [11.34]						
		268 [10.55]	300 [11.81]						
		293 [11.54]	325 [12.80]						
		318 [12.52]	350 [13.78]						
		343 [13.50]	375 [14.76]						
		368 [14.49]	400 [15.75]						
		418 [16.46]	450 [17.72]						

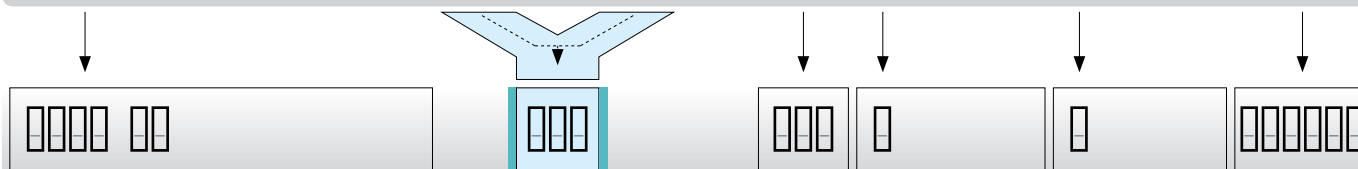

ORDERING EXAMPLE: 0720 118 150 0 0 000062

Crossbar on outside bend, crossbar on inside bend, can be opened from inside and outside bend
 Inside width 4.65 in.; radius 5.91 in.
 Plastic crossbar, full-ridged with bias, material black-colored polyamide
 Chain length 62 in. (16 links)

NOTE ON CONFIGURATION

Aluminum crossbars:

Aluminum crossbars in 0.04 in (1 mm) width sizes for inner widths from 2.83 inch – 23.62 inch are available for delivery.

Strain relief:

The end brackets utilize strain relief plates (ZL) for cable strain relief.

For detailed information, please consult the corresponding product documentation.

SELF-SUPPORTING LENGTH

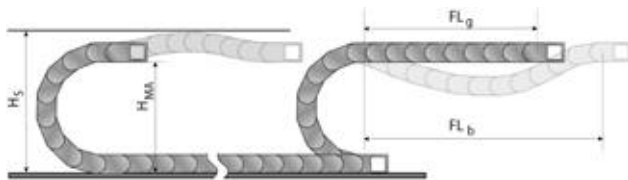

The self-supporting length is the distance between the chain bracket on the moving end and the start of the chain arch. The installation variant FL_g offers the lowest load and wear for the cable drag chain. The maximum travel parameters (speed and acceleration) can be applied for this variant.

- H_s = Installation height plus safety
- H_{MA} = Height of moving end connection
- FL_g = Self-supporting length, upper run straight
- FL_b = Self-supporting length, upper run bent

LOAD DIAGRAM FOR SELF-SUPPORTING APPLICATIONS

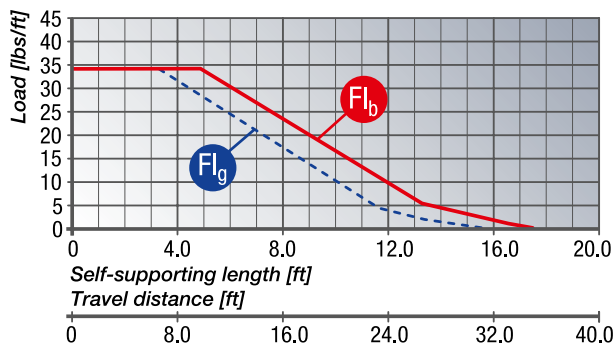

FL_g Self-supporting length, upper run straight

In the FL_g range, the chain upper run still has a bias, is straight or has a maximum sag of 3.15 inch.

FL_b Self-supporting length, upper run bent

In the FL_b range, the chain upper run has a sag of more than 3.15 inch, but this is still less than the maximum sag. Where the sag is greater than that permitted in the FL_b range, the application is critical and should be avoided. The self-supporting length can be optimized by using a support for the upper run or a more stable cable drag chain.

DETERMINING THE CHAIN LENGTH

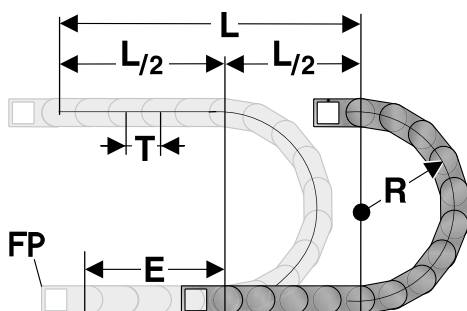

The fixed point of the cable drag chain should be connected in the middle of the travel distance.

This arrangement gives the shortest connection between the fixed point (FP) and the moving bracket and thus the most efficient chain length.

Chain length calculation = $L/2 + \pi * R + E$
 $\approx 1 \text{ ft chain} = 10 \text{ qty.} \times 3.94 \text{ inch.}$

- E = Distance between entry point and middle of travel distance
- L = Travel distance
- R = Radius
- P = Grid 3.94 inch

INSTALLATION DIMENSIONS

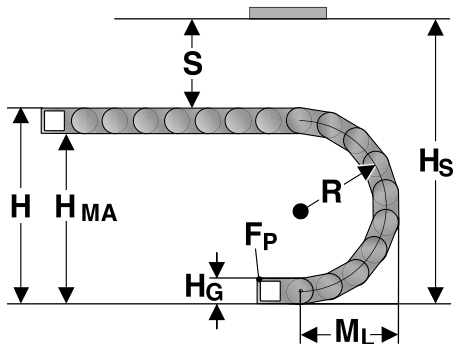

The moving end chain connection is to be screw fixed at height H_{MA} for the respective radius.
For the installed dimension the “Installed height H_s ” value has to be taken into account.

Radius R	5.91	7.87	9.84	11.81	15.75	19.69
Outside height of chain link (H_o)	4.02	4.02	4.02	4.02	4.02	4.02
Height of bend (H)	16.62	20.54	24.48	28.42	36.30	44.18
Height of moving end connection (H_{MA})	12.60	16.52	20.46	24.40	32.28	40.16
Safety margin (S)	0.79	0.79	0.79	0.79	0.79	0.79
Installation height (H_s)	17.41	21.33	25.27	29.21	37.09	44.97
Arc projection (M_L)	12.25	14.21	16.18	18.15	22.09	26.03

HEAVYLINE PLASTIC CROSSBAR



The crossbars connect the two side runs of the cable drag chain. The crossbar length is synonymous with the inside width of the cable drag chain.

Type	Order No.	Description	Inside width inch
BS 093-7	072009300000	Crossbar	3.66
BS 106-7	072010600000	Crossbar	4.17
BS 118-7	072011800000	Crossbar	4.65
BS 131-7	072013100000	Crossbar	5.16
BS 143-7	072014300000	Crossbar	5.63
BS 156-7	072015600000	Crossbar	6.14
BS 168-7	072016800000	Crossbar	6.61
BS 181-7	072018100000	Crossbar	7.13
BS 193-7	072019300000	Crossbar	7.60
BS 206-7	072020600000	Crossbar	8.11
BS 231-7	072023100000	Crossbar	9.09
BS 243-7	072024300000	Crossbar	9.57
BS 256-7	072025600000	Crossbar	10.08
BS 268-7	072026800000	Crossbar	10.55
BS 293-7	072029300000	Crossbar	11.54
BS 318-7	072031800000	Crossbar	12.52
BS 343-7	072034300000	Crossbar	13.50
BS 368-7	072036800000	Crossbar	14.49
BS 418-7	072041800000	Crossbar	16.46
BS 468-7	072046800000	Crossbar	18.43
BS 518-7	072051800000	Crossbar	20.39

CHAIN BRACKET KA 72

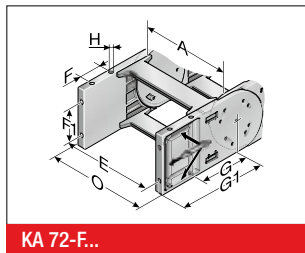

KA 72-F...

This chain bracket offers universal connection options (top, bottom and front) and is attached to the ends of the chain like a side link. This allows the chain to move right up to the bracket. Each chain requires one male and one female bracket. M10 screws are used to secure the brackets in place. Metal inserts (supplied) help to minimize the cold flow properties. This is an enormous advantage, guaranteeing the smooth transfer of high loads to the chain.

Type	Order No.	Material	Version	Inside width								Outside width of KA 0
				A inch	E inch	F inch	F1 inch	G inch	G1 inch	HØ inch		
KA 72-F Female end	0720000054	Plastic	with bush	3.66 – 20.39	A+0.43	1.38	1.77	4.21	6.75	0.43	A+1.26	
KA 72-F male end	0720000055	Plastic	with bush	3.66 – 20.39	A+0.43	1.38	1.77	4.21	6.75	0.43	A+1.26	

KA 72 CHAIN BRACKET ANGLE

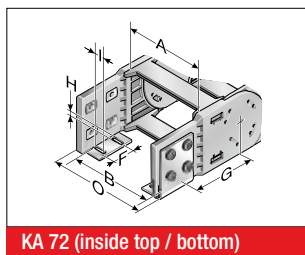

KA 72 (inside top / bottom)

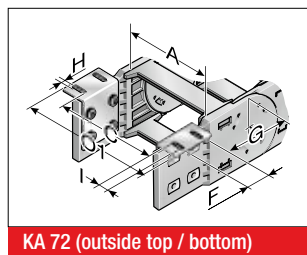

KA 72 (outside top / bottom)

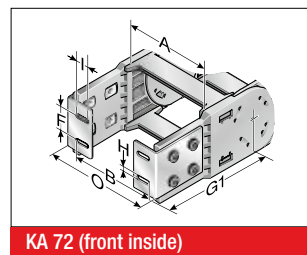

KA 72 (front inside)

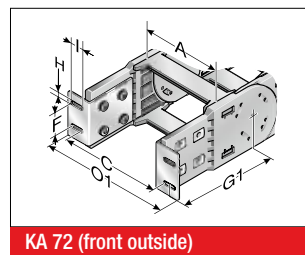

KA 72 (front outside)

There are several options regarding the chain bracket. The fixed-point bracket (inside/bottom) and the moving end bracket (inside/top) are supplied as standard. However, any other combination can be supplied upon request. The chain bracket

is fastened at the end like a side link. This enables the chain to move right up to the bracket. Each chain requires one male and one female bracket. The brackets should be fastened with M8 screws.

Type	Order No.	Material	Inside width								Outside width of KA 0	Outside width of KA 01
			A inch	B inch	C inch	F inch	G inch	G1 inch	HØ inch	I inch		
KA 72 Female end	0720000050	Sheet steel	3.66 – 20.39	A-0.63	A+1.89	1.77	4.17	7.07	0.35	1.26	A+1.26	A+4.96
KA 72 Male end	0720000051	Sheet steel	3.66 – 20.39	A-0.63	A+1.89	1.77	4.17	7.07	0.35	1.26	A+1.26	A+4.96

MP 72 SEPARATOR

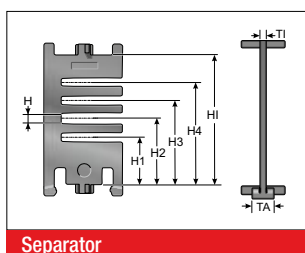

Separator

We recommend that separators be used if multiple round cables or conduits with differing diameters are to be installed.

Type	Order No.	Description	Version	TI inch	TA inch	H inch	H1 inch	H2 inch	H3 inch	H4 inch	HI inch
TR 72	072000009200	Separator	lockable	0.14	0.51	0.22	1.00	1.42	1.83	2.24	2.83

RTT 72 SHELF SUPPORT, DIVISIBLE

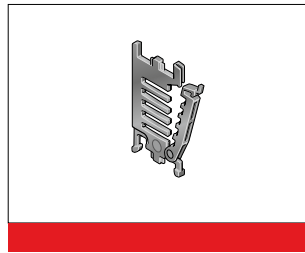
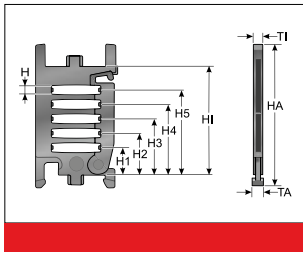

In connection with two separable shelf supports (RTT) with at least one end-to-end shelf (RB) the shelf becomes an easy to fill shelving system. The additional levels prevent cables from criss-crossing and minimize the friction between them.

Type	Order No.	Description	Version	TI inch	TA inch	H inch	H1 inch	H2 inch	H3 inch	H4 inch	H5 inch	HI inch
RTT 72	100090722000	Shelf support, divisible	lockable	0.31	0.31	0.22	0.59	1.00	1.42	1.83	2.24	2.83

RB-7 SHELF

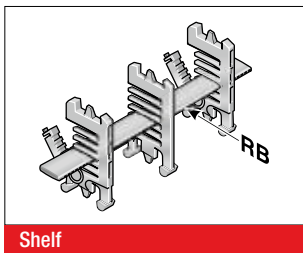

In connection with at least two separable shelf supports (RTT), the shelf becomes a shelving system. The additional levels prevent cables from criss-crossing and minimize the friction between them.

Type	Order No.	Description	Width inch	Inside width inch
RB 056-7	100000005600	Shelf	2.20	3.66
RB 061-7	1000006107	Shelf	2.40	3.66
RB 066-7	100000006600	Shelf	2.60	3.66
RB 071-7	1000007107	Shelf	2.80	3.66
RB 076-7	1000007607	Shelf	2.99	3.66
RB 081-7	100000008100	Shelf	3.19	3.66
RB 086-7	1000008607	Shelf	3.39	3.66
RB 091-7	1000009107	Shelf	3.58	4.17
RB 096-7	1000009607	Shelf	3.78	4.17
RB 101-7	1000010107	Shelf	3.98	4.17
RB 106-7	100000010600	Shelf	4.17	4.17
RB 111-7	1000011107	Shelf	4.37	4.65
RB 116-7	100000011600	Shelf	4.57	4.65
RB 121-7	1000012107	Shelf	4.76	5.16
RB 126-7	1000012607	Shelf	4.96	5.16
RB 131-7	1000013107	Shelf	5.16	5.63
RB 136-7	1000013607	Shelf	5.35	5.63
RB 141-7	1000014107	Shelf	5.55	5.63
RB 146-7	1000014607	Shelf	5.75	6.14
RB 151-7	1000015107	Shelf	5.94	6.14
RB 156-7	1000015607	Shelf	6.14	6.14
RB 161-7	1000016107	Shelf	6.34	6.61

RB-7 SHELF

Type	Order No.	Description	Width inch	Inside width inch
RB 166-7	10000016600	Shelf	6.54	6.61
RB 171-7	1000017107	Shelf	6.73	7.13
RB 176-7	1000017607	Shelf	6.93	7.13
RB 181-7	1000018107	Shelf	7.13	7.60
RB 186-7	1000018607	Shelf	7.32	7.60
RB 191-7	1000019107	Shelf	7.52	7.60
RB 196-7	1000019607	Shelf	7.72	8.11
RB 201-7	1000020107	Shelf	7.91	8.11
RB 206-7	1000020607	Shelf	8.11	8.11
RB 211-7	1000021107	Shelf	8.31	8.58
RB 216-7	10000021600	Shelf	8.50	8.58

RSV 72 CROSSBAR CONNECTOR



For crossbars wider than 9.69 inch (246 mm), we recommend the use of crossbar connectors. These prevent deformation to the crossbar under large amounts of additional weight of the chain assembly.

Type	Order No.	Description	TI inch
RSV 72	072000009600	Crossbar connector	0.31
RSV 72 Alu	072000009800	Crossbar connector for aluminum crossbars	0.31

RE 72 H-SHAPED SHELF UNIT

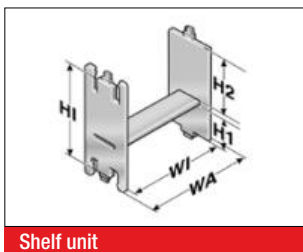

One-piece shelving system, the shelf cannot be varied in height.

Type	Order No.	Description	WA inch	WI inch	H1 inch	H2 inch	HI inch
RE 75/24	100000752418	H-shaped shelf unit	2.95	2.66	1.69	0.94	2.83
RE 75/36	100000753618	H-shaped shelf unit	2.95	2.66	1.32	1.32	2.83

RS-ZL-7 CROSSBAR STRAIN RELIEF PLATE

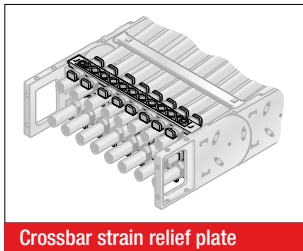

Fixed integrated crossbar strain relief plates in the chain brackets. Accommodated to all widths of the frame ridges, up to 10.08 inch in size. May be assembled on the inside and outside bends at both chain endings.

Type	Order No.	Description	Inside width inch
RS-ZL 093-7	072009300010	Crossbar strain relief plate	3.66
RS-ZL 106-7	072010600010	Crossbar strain relief plate	4.17
RS-ZL 118-7	072011800010	Crossbar strain relief plate	4.65
RS-ZL 131-7	072013100010	Crossbar strain relief plate	5.16
RS-ZL 143-7	072014300010	Crossbar strain relief plate	5.63
RS-ZL 156-7	072015600010	Crossbar strain relief plate	6.14
RS-ZL 168-7	072016800010	Crossbar strain relief plate	6.61
RS-ZL 181-7	072018100010	Crossbar strain relief plate	7.13
RS-ZL 193-7	072019300010	Crossbar strain relief plate	7.60
RS-ZL 206-7	072020600010	Crossbar strain relief plate	8.11
RS-ZL 218-7	072021800010	Crossbar strain relief plate	8.58
RS-ZL 231-7	072023100010	Crossbar strain relief plate	9.09
RS-ZL 243-7	072024300010	Crossbar strain relief plate	9.57
RS-ZL 256-7	072025600010	Crossbar strain relief plate	10.08

STRAIN RELIEF WITH STEEL FIX

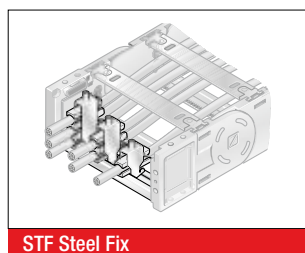
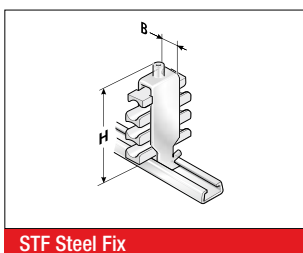

C-rails (galvanized) for permanent integration, for accommodating the Steel Fix bow clamps in the chain brackets. The bow clamps can take up to 3 cables and are suitable for C-rails with a groove width of 0.43 in (11 mm). Due to the design of the trough elements, a cable preserving cable guidance is ensured. May be assembled on the inside and outside bends at both chain endings. The overall height stated is a guide only. The actual height is, amongst other things, dependent on the diameter and the quality of the cable. A safety distance of 0.39 in (10 mm) at the fixed point above the strain relief must be kept during gliding applications.

Type	Order No.	Description	Seats qty.	Cable Ø inch	Width (B) inch	Total height (H) inch
Single clamp (for one cable)						
STF 12-1 Steel Fix	81661801	Hooped clamp	1	0.24 – 0.47	0.63	2.17
STF 14-1 Steel Fix	81661802	Hooped clamp	1	0.47 – 0.55	0.71	2.05
STF 16-1 Steel Fix	81661803	Hooped clamp	1	0.55 – 0.63	0.79	2.13
STF 18-1 Steel Fix	81661804	Hooped clamp	1	0.63 – 0.71	0.87	2.20
STF 20-1 Steel Fix	81661805	Hooped clamp	1	0.71 – 0.79	0.94	2.32
STF 22-1 Steel Fix	81661806	Hooped clamp	1	0.79 – 0.87	1.02	2.40

STRAIN RELIEF WITH STEEL FIX

Type	Order No.	Description	Seats qty.	Cable Ø inch	Width (B) inch	Total height (H) inch
STF 26-1 Steel Fix	81661807	Hooped clamp	1	0.87 – 1.02	1.18	2.76
STF 30-1 Steel Fix	81661808	Hooped clamp	1	1.02 – 1.18	1.34	2.91
STF 34-1 Steel Fix	81661809	Hooped clamp	1	1.18 – 1.34	1.50	3.07
STF 38-1 Steel Fix	81661810	Hooped clamp	1	1.34 – 1.50	1.65	3.23
STF 42-1 Steel Fix	81661811	Hooped clamp	1	1.50 – 1.65	1.81	3.58
Double clamp (for two cables)						
STF 12-2 Steel Fix	81661821	Hooped clamp	2	0.24 – 0.47	0.63	2.87
STF 14-2 Steel Fix	81661822	Hooped clamp	2	0.47 – 0.55	0.71	2.91
STF 16-2 Steel Fix	81661823	Hooped clamp	2	0.55 – 0.63	0.79	3.23
STF 18-2 Steel Fix	81661824	Hooped clamp	2	0.63 – 0.71	0.87	3.39
STF 20-2 Steel Fix	81661825	Hooped clamp	2	0.71 – 0.79	0.94	3.58
STF 22-2 Steel Fix	81661826	Hooped clamp	2	0.79 – 0.87	1.02	3.74
STF 26-2 Steel Fix	81661827	Hooped clamp	2	0.87 – 1.02	1.18	4.25
STF 30-2 Steel Fix	81661828	Hooped clamp	2	1.02 – 1.18	1.34	4.76
STF 34-2 Steel Fix	81661829	Hooped clamp	2	1.18 – 1.34	1.50	5.08
Triple clamp (for three cables)						
STF 12-3 Steel Fix	81661841	Hooped clamp	3	0.24 – 0.47	0.63	3.86
STF 14-3 Steel Fix	81661842	Hooped clamp	3	0.47 – 0.55	0.71	3.86
STF 16-3 Steel Fix	81661843	Hooped clamp	3	0.55 – 0.63	0.79	4.13
STF 18-3 Steel Fix	81661844	Hooped clamp	3	0.63 – 0.71	0.87	4.37
STF 20-3 Steel Fix	81661845	Hooped clamp	3	0.71 – 0.79	0.94	4.65
STF 22-3 Steel Fix	81661846	Hooped clamp	3	0.79 – 0.87	1.02	5.12

MP 52/62/72 LOCK BUTTON

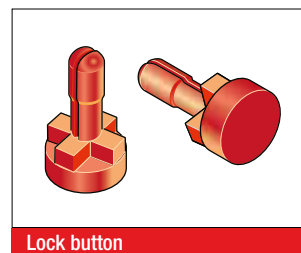
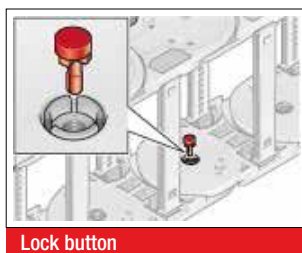
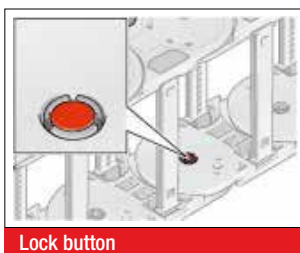

To increase the side stability we recommend the use of lock buttons during strong lateral acceleration or when installed “laying

on the side (turned 90°) without support”.

Type	Order No.
MP52/62/72 lock button	0520000080

LOWERED FIXING POINT MP 72

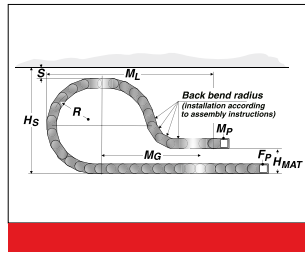
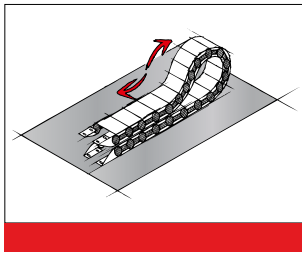

It is sometimes necessary to lower the height of the moving attachment point.

In such cases, modifications to the chain layout should be noted (e.g. extension of chain).

Please contact our application engineers.

Radius R inch	Height of moving end connection (H _{MA}) inch	Safety margin (S) inch	Installation height incl. safety (S) inch	Projection (M _I) inch	Additional links qty.	of which additional back chain links qty.
7.87	9.45	2.36	22.83	33.46	9	2
9.84	10.24	2.36	26.77	39.76	12	3
11.81	11.42	2.36	30.71	45.28	13	3
15.75	13.78	2.36	38.58	53.54	16	3
19.69	15.75	2.36	46.46	63.78	20	3

MP 72 REARWARD RADII

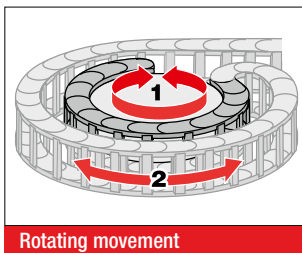

Side links with forward radius (R) and rearward radius (Rü) allow movements in both directions. This is intended for rotating movements and lowered chain brackets. Note: This type of chain has different chain links for the left or right side! Rotation movements are only possible with open variants.

Type	Order No.	Radius inch	Back radius inch
SR 72 (RÜ300/R300) left	072000030060	11.81	11.81
SR 72 (RÜ300/R300) right	072000030062	11.81	11.81

GUIDE CHANNEL VAW (ALUMINUM / STAINLESS STEEL)



A range of variable guide channel systems, constructed from aluminum or stainless steel sections, is available for this cable drag chain. The variable guide channel ensures that the cable drag chain is supported and guided securely.

ASSEMBLY INSTRUCTION FLEXIBLE CHAIN BRACKET EB

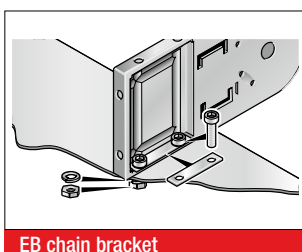

The flexible chain bracket is delivered with insert panels to reduce the plastic's cold flow properties.

ASSEMBLY

DISASSEMBLY

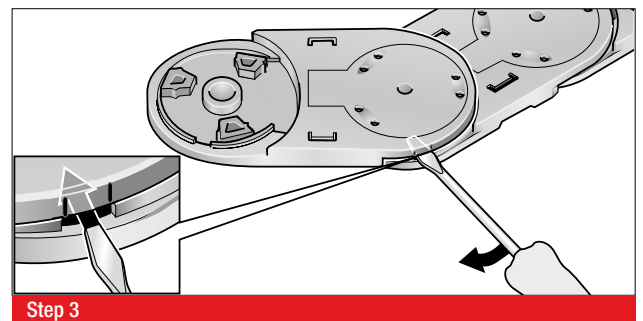
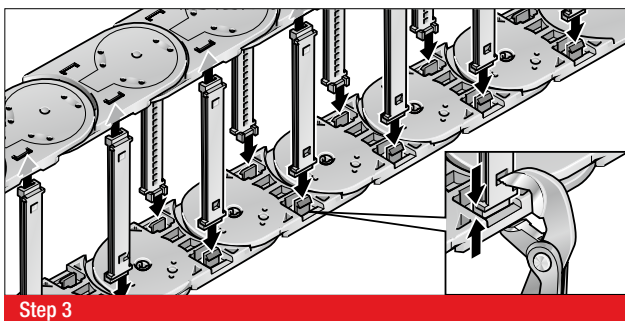
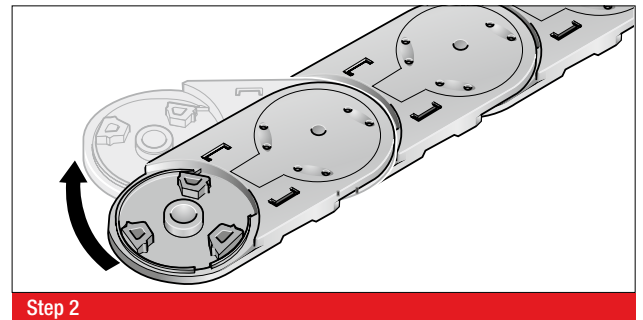
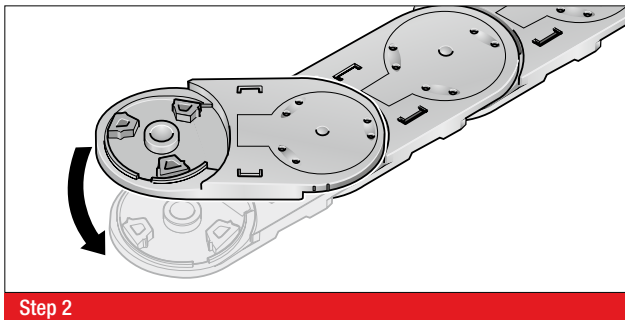
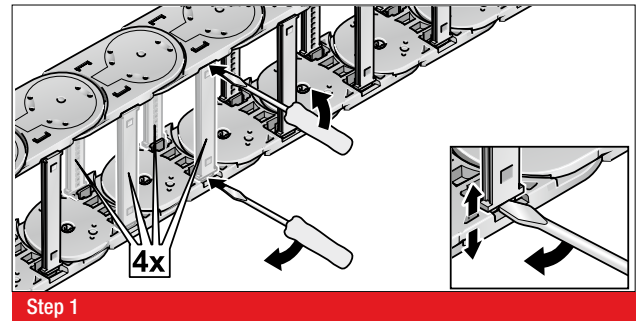
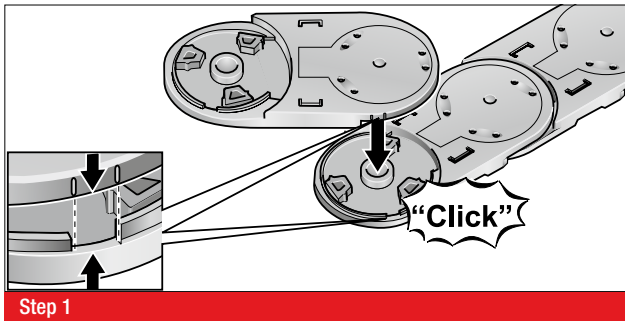

Strain relief systems



Introduction

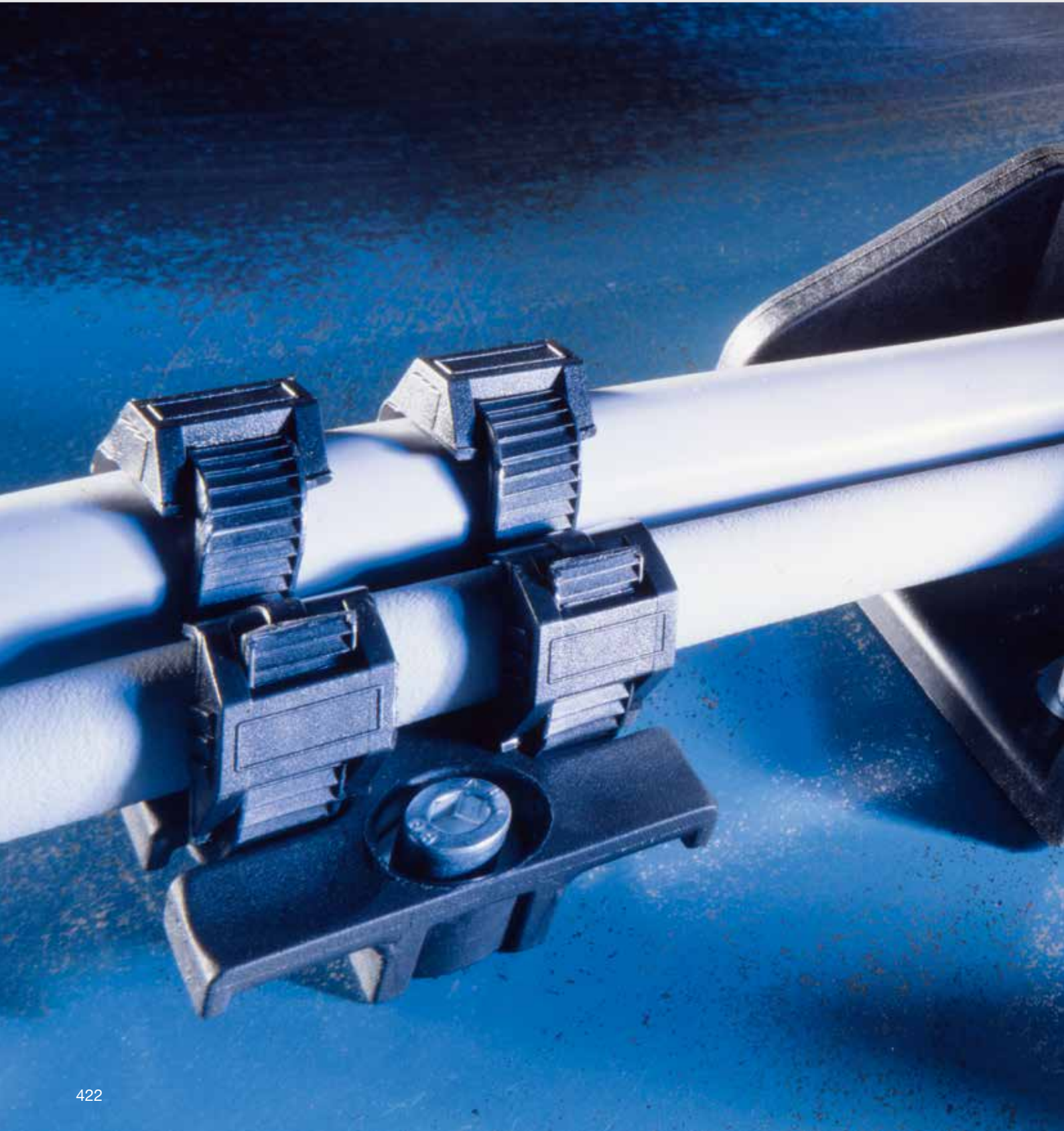



For every system:

The right strain relief

Cables and conduits that are to be routed in a cable drag chain should always be secured using a strain relief mechanism.

The right strain relief mechanism has a positive effect on the durability of the cables and conduits.

ZL (strain relief plate)

This strain relief mechanism offers a safe and cost-effective system using cable ties. The insertable bushing (ELB) stops the cold extrusion characteristic of plastic from affecting the secure fixing of the plate. The spacer sleeve (DH) enables a double-deck mounting option.

RS-ZL (crossbar strain relief plate)

The crossbar strain relief plate is snapped-in to the cable drag chain's chain brackets. Two RS-ZL units can be mounted on each of the two chain ends (on the inside and the outside bend). The cables are secured using cable ties.

Steel Fix bow clamp

A C-rail (slot width 11 mm), integrated into the chain bracket, serves to secure the Steel Fix bow clamps. The bow clamps can be used for strain relief of one, two or three cables arranged on top of each other. In the standard design, the housing body is protected against corrosion by cathodic dip painting. A stainless steel model is also available.

Strain relief plate (ZL) mounted in a cable drag chain's chain bracket.



Benefits

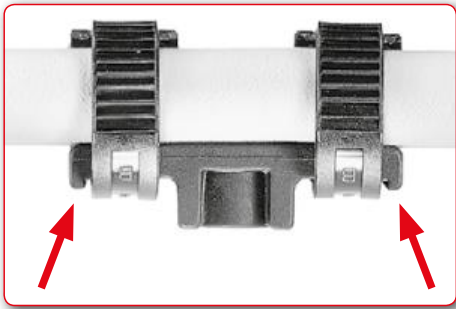

Secure hold

The undercut on the underside of the plate prevents the cable tie from slipping off – even with very large cable diameters.

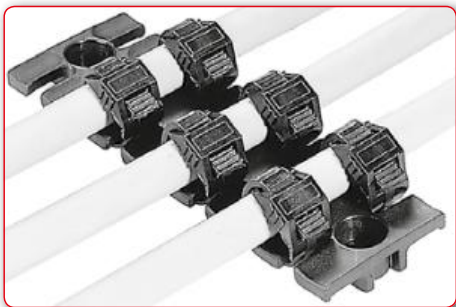

Longer life

Each cable is secured by two power cable ties on each end. This spreads the pressure on the cable and thereby minimizes the risk of damage to the cable core.



Wide support face on the individual plate tongues

The cables are optimally secured by the wide supporting surfaces of the individual strain relief tongues. The wide power cable ties help to facilitate strain relief which is quick and simple but gentle on the cables.

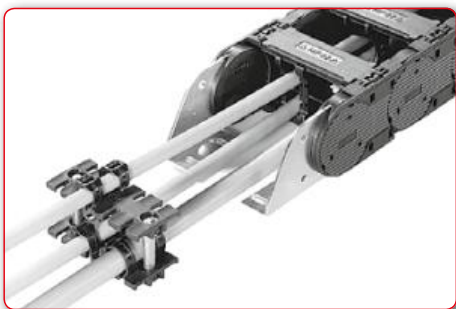

Two-tier assembly

The DH spacer sleeves allow mounting one above the other.

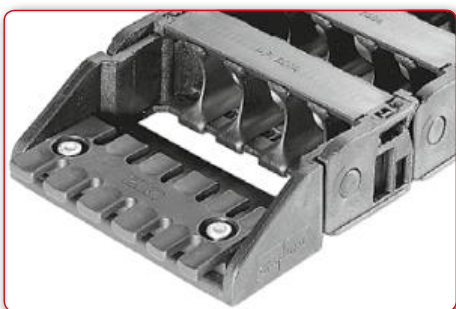

Compatible fixing holes

The dimensions of the holes on the plates system match those on the chain brackets.

Please note the dimension of the holes on the strain relief plate when using strain relief in the chain bracket.



Durable fastening with metal bushing.

The metal bushings inhibit cold flow properties. Metal is screwed onto metal. The screws are prevented from working loose. (Please order separately.)



Easy assembly

Even if two cables are immediately next to each other, it is possible to secure them with two power cable ties.



Different cable diameters

The flexible use of power cable ties provides strain relief which is quick and simple but very gentle on the cables, even for cables of very different diameters with extremely high packing density.

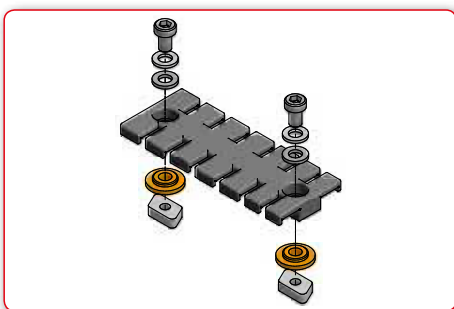

Single or as a complete set

Our strain relief plates are available singly or in a set, e.g. for mounting on a C-rail:

A strain relief plate, complete with cylinder head bolt, plain and serrated washer, insert bushings and T-slot nut.



Steel Fix bow clamps

- for C-rails with a groove width of 0.43 inch (11 mm)
- for one, two or three cables on top of each other
- Corrosion protection via cathodic dip painting (CDP)
- Trough elements with low-wear cable design
- Stainless steel design available on request

Selection criteria / engineering notes

Where is the strain relief made?

For cable drag chains with standard inside widths of up to 9.57 inch (243 mm), crossbar strain relief plates (RS-ZL) are the ideal solution for relieving power cabling and media conduits from strain in a space-saving, secure way. They are supplied in the same widths as the crossbars for the respective chain type.

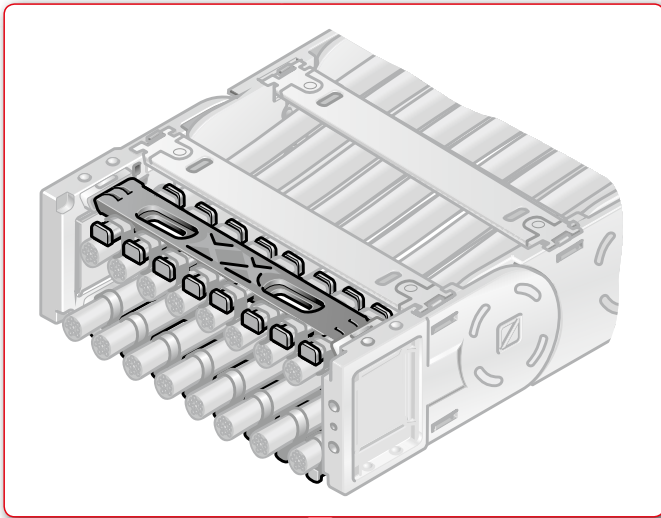

They are secured in much the same way as the crossbars themselves, by snapping them into pre-cut recesses in the chain brackets. This enables two strain relief plates to be integrated into the cable drag chain per cable end, both for the inside bend and the outside bend.

As an alternative, the same recesses that accept a crossbar strain relief plate can also be used for the fixed integration of a C-rail. This enables the

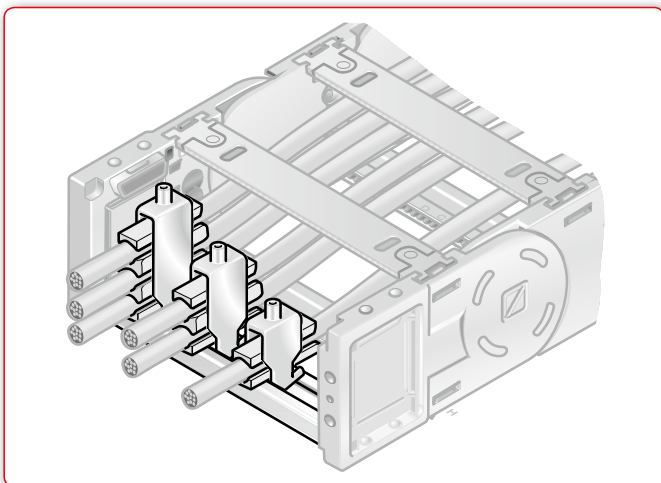

provision of rapid and reliable strain relief even for individual chain inside widths that differ from the grid spacings.

We offer two separate strain relief systems for this specific application:

The first is to use our Steel Fix bow clamps, which accept up to three power cables on top of one another per fixing element. The second option is ZL-format strain relief plates, which match crossbar strain relief plates in form and function.

The options described above assume that the distance from the last movable point of the cable drag chain to the strain relief mechanism is sufficient for all of the installed power cabling/media conduits (depends on the minimum bending radius).

If this is not the case, then you will need to use one of the options as described below:

1. Reposition strain relief in front of chain

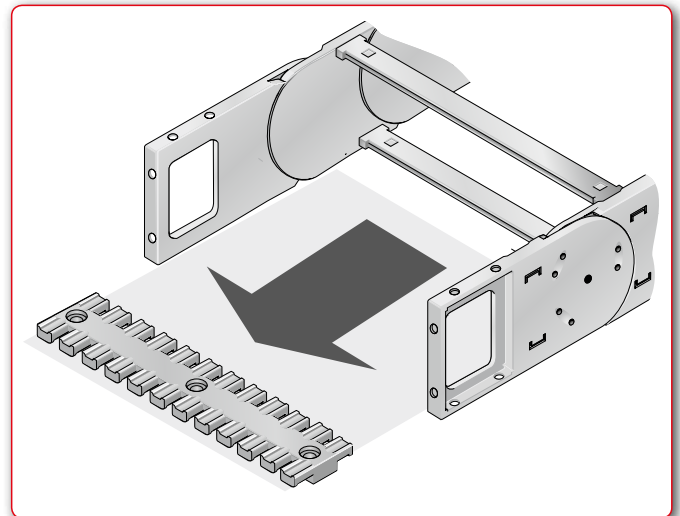

To increase the distance from the strain relief to the first movable point, the strain relief can be moved to a position outside the chain bracket. To do so, you can utilise our Steel Fix bow clamps and ZL-C strain relief plates, which are mounted on C-rails. The ZL strain relief plates can also be secured to a load-bearing substrate directly, without using C-rails.

A further positive effect of this option is that the chain bracket itself remains free of additional pulling forces.

Design / structure

2. Lengthening the chain

If the installation space available permits and the circular arc distance may be increased still further, then the installation of additional chain links can also be used to achieve the necessary distance between the strain relief and the first movable point of the chain.

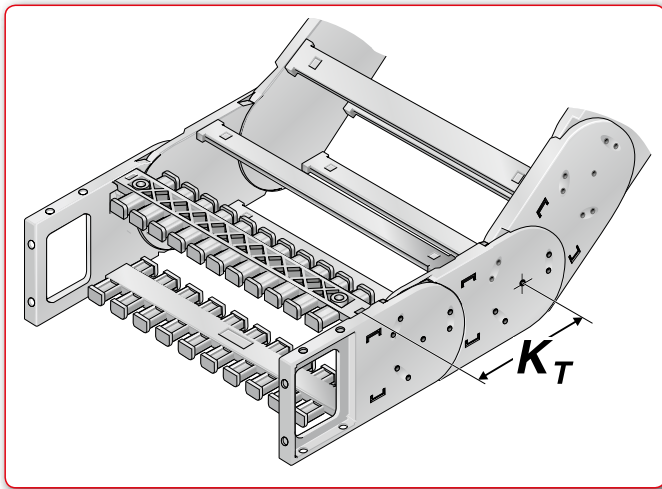

Note on installation width when using a permanently installed C-rail.

To secure a C-rail within the chain bracket (order no.: 81661610), one fixing clip is inserted into the C-rail on both sides. This slightly reduces the installation space available for strain relief plates or for bow clamps. The space required for the mounting clip depends on the chain type deployed and is in the range 0.16–0.59 inch (4–15 mm). Please contact our layout experts.

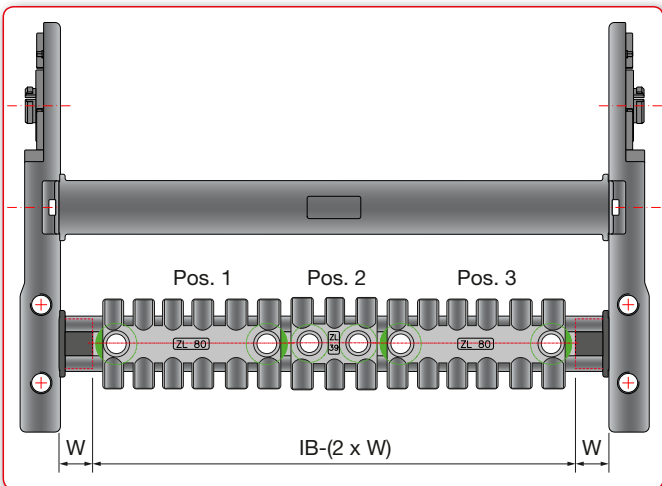

Solutions for inside widths over 243 mm

For our *HeavyLine* and *PowerLine* chains, the RS-ZL strain relief plate offers standard solutions up to an inside width of 243 mm. For larger inside widths, multiple strain relief plates are combined together and mounted on a C-rail (order no.: 81661610). We recommend the following solutions:

Inside width in inch			Recommended ZL combinations			
Nominal	-2xW	Effective	Item 1	Item 2	Item 3	Item 4
9.69	1.18	8.50	ZL 87	ZL 39	ZL 87	
9.92	1.18	8.74	ZL 39	ZL 121	ZL 60	
10.08	1.18	8.90	ZL 87	ZL 140		
10.16	1.18	8.98	ZL 87	ZL 140		
10.55	1.18	9.37	ZL 60	ZL 87	ZL 87	
11.54	1.18	10.35	ZL 87	ZL 87	ZL 87	
11.65	1.18	10.47	ZL 87	ZL 180		
12.52	1.18	11.34	ZL 60	ZL 87	ZL 140	
13.50	1.18	12.32	ZL 87	ZL 103	ZL 121	
13.62	1.18	12.44	ZL 87	ZL 87	ZL 140	
13.78	1.18	12.6	ZL 180	ZL 140		
14.09	1.18	12.91	ZL 121	ZL 103	ZL 103	
14.49	1.18	13.31	ZL 80	ZL 80	ZL 180	
14.61	1.18	13.43	ZL 140	ZL 121	ZL 39	ZL 39
15.59	1.18	14.41	ZL 121	ZL 103	ZL 140	
16.46	1.18	15.28	ZL 87	ZL 121	ZL 180	
16.57	1.18	15.39	ZL 140	ZL 121	ZL 87	ZL 39
17.56	1.18	16.38	ZL 87	ZL 121	ZL 121	ZL 87
18.43	1.18	17.24	ZL 87	ZL 87	ZL 87	ZL 180
19.53	1.18	18.35	ZL 121	ZL 121	ZL 103	ZL 121
20.39	1.18	19.21	ZL 87	ZL 103	ZL 121	ZL 180
21.50	1.18	20.31	ZL 39	ZL 121	ZL 180	ZL 180

How is the strain relief applied?

The strain relief itself should be fitted with two power cable ties on each side of the cable and secured approx. 20 to 30 x cable diameters away from the last moving chain link.

The strain relief is suitable for cables up to approx. 1.75 inch (40 mm) in diameter.

All electric cables must be relieved of strain at both the moving and fixed end. For longer travel distances (and gliding applications), strain relief on one side at the moving end is recommended. Care must be taken to ensure pressure on the power cabling is applied broadly across its outer jacket.

Strain relief plate, type ZL-C set and ZL

The ZL-C set and ZL type strain relief plates are used for strain relief when laying various different cables on machines and installations. When used in cable drag chains, the cables are secured to the strain relief plates on both sides of the chain with type KB 28 power cable ties (order no.: 87661258).

The undercut on the strain relief plates prevent the power cable ties from slipping off, even when the routed cable diameter is itself larger than the plate tongue. Every cable is clamped twice at each end with cable ties.

The actual strain relief is accomplished using cable ties. We recommend using our own type KB power cable ties. These are equipped with a special locking mechanism and are especially suitable for heavy-duty applications. Wide, highly flexible power cable ties increase the surface pressure and ensure longer service life.

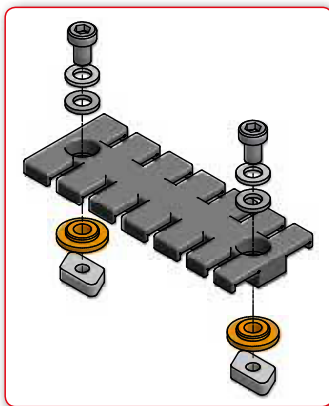

ZL-C set

In addition to a type ZL strain relief plate, the ZL-C sets contain a complete set of installation materials, such as washers, serrated and spacer washers, plus T-slot nuts for installation in the C-rail.

Type	ZL-C 39 set	Type	ZL 39
Order no.	87702810	Order no.	87701014
A =	1.52 in	X =	0.35 in
B =	1.57 in	Y =	0.35 in
C =	0.77 in		
D =	0.47 in	G =	0.39 in
E =	0.35 in	H =	0.12 in
F =	0.55 in		

Type	ZL-C 60 set	Type	ZL 60
Order no.	87702812	Order no.	87701016
A =	2.34 in	X =	0.35 in
B =	1.57 in	Y =	0.28 in
C =	1.71 in	Z =	2.42 in
D =	0.47 in	G =	0.39 in
E =	0.35 in	H =	0.12 in
F =	0.55 in		

Type	ZL-C 80 set	Type	ZL 80
Order no.	87702814	Order no.	87701015
A =	3.13 in	X =	0.22 in
B =	1.57 in	Y =	0.22 in
C =	2.68 in	Z =	3.39 in
D =	0.47 in	G =	0.39 in
E =	0.35 in	H =	0.12 in
F =	0.55 in		

Type	ZL-C 87 set	Type	ZL 87
Order no.	87702816	Order no.	87701018
A =	3.41 in	X =	0.35 in
B =	1.57 in	Y =	0.37 in
C =	2.70 in		
D =	0.47 in	G =	0.39 in
E =	0.35 in	H =	0.12 in
F =	0.55 in		

Type	ZL-C 103 set	Type	ZL 103
Order no.	87702818	Order no.	87701020
A =	4.04 in	X =	0.35 in
B =	1.57 in	Y =	0.37 in
C =	0.37 in	D =	0.47 in
		E =	0.35 in
		F =	0.55 in
		G =	0.39 in
		H =	0.12 in

Legend for dimensions	Cross-section
Z = Installation width = C+X+Y	
A = Length	
B = Width	
C = Hole spacing	
X = Hole spacing to edge	
Y = Hole spacing to edge	
Z = Installation width	
D = Inside diameter (above)	
E = Inside diameter (below)	
F = Outside diameter (below)	
G = Assembly height	
H = Material thickness	

Strain relief plate, type ZL / two-tier strain relief plate

Type ZL-C 121 set		Type ZL 121	
Order no.	87702820	Order no.	87701022
A = 4.76 in	X = 0.35 in	D = 0.47 in	G = 0.39 in
B = 1.57 in	Y = 0.37 in	E = 0.35 in	H = 0.12 in
C = 4.04 in		F = 0.55 in	

Type ZL-C 140 set		Type ZL 140	
Order no.	87702822	Order no.	87701024
A = 5.49 in	X = 0.35 in	D = 0.47 in	G = 0.39 in
B = 1.57 in	Y = 0.37 in	E = 0.35 in	H = 0.12 in
C = 4.78 in		F = 0.55 in	

Type ZL-Cset 180/6		Type ZL 180/6	
Order no.	87702824	Order no.	87701026
A = 7.0 in	X = 0.35-0.46	D = 0.47 in	G = 0.45 in
B = 1.65 in	Y = 0.35-0.46	E = 0.35 in	H = 0.13 in
C = 6.08-6.30 in		F = 0.63 in	

Type Not a set		Type ZL 180/8	
Order no.	--	Order no.	87701027
A = 7.0 in	X = 0.35-0.46	D = 0.53 in	G = 0.45 in
B = 1.65 in	Y = 0.35-0.46	E = 0.43 in	H = 0.13 in
C = 6.08-6.30 in		F = 0.63 in	

Two-tier installation

When deploying a shelving system and to achieve highed packing densities, you can also installtwo strain relief plates above each other. The necessary distance between the levels is ensured by using spacer sleeves type DH.

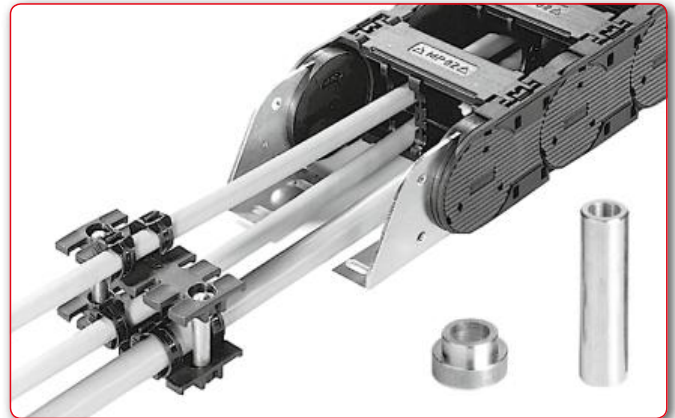

Type ELB/6	
Order no.	87701050
A = 0.26 / B = 0.47 / C = 0.24	

Type ELB/8	
Order no.	87701060
A = 0.26 / B = 0.53 / C = 0.32	

Dimensions in inch

Type DH 32/6	
Order no.	87701052
A = 1.26 / B = 0.47 / C = 0.25	

Type DH 32/8	
Order no.	87701062
A = 1.26 / B = 0.51 / C = 0.33	

Dimensions in inch

Steel Fix bow clamp

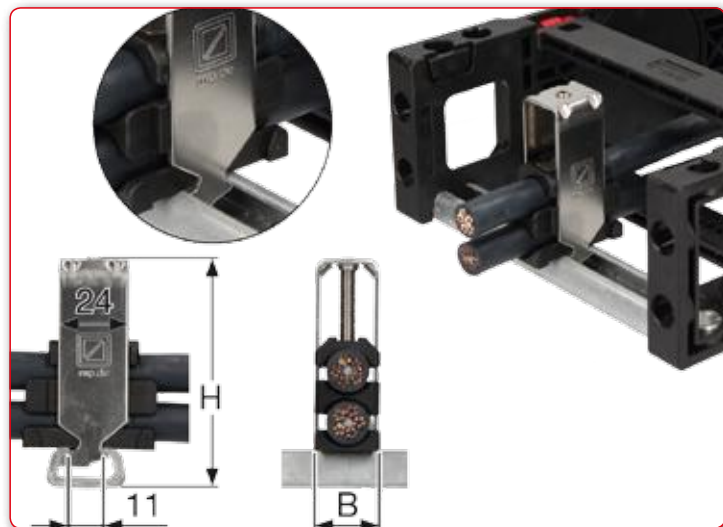

A permanently integrated C-rail (dip galvanised, order no. 81661610) for accommodating the Steel Fix bow clamps in the chain brackets.

The bow clamps can take up to 3 cables and are suitable for C-rails with a slot width of 11 mm. Due to the design of the trough elements, a cable preserving cable guidance is ensured. Adjusted to all chain inside widths up to 200 mm in size. May be assembled on the inside and outside bends at both chain endings.

A stainless steel model is also available.

The overall height stated is a guide only. The actual height is, amongst other things, dependent on the diameter and the quality of the cable. A safety distance of 10 mm at the fixed point above the strain relief must be kept during gliding applications.

Type	Order no.	Cable Ø inch	Width (B) inch	Height (H)* inch	Pitch (T)
Single bow clamp (for 1 cable)					
STF 12-1 Steel Fix	81661801	0.24 – 0.47	0.63	2.17	0.94 in (24 mm)
STF 14-1 Steel Fix	81661802	0.47 – 0.55	0.71	2.05	0.94 in (24 mm)
STF 16-1 Steel Fix	81661803	0.55 – 0.63	0.79	2.13	0.94 in (24 mm)
STF 18-1 Steel Fix	81661804	0.63 – 0.71	0.87	2.20	0.94 in (24 mm)
STF 20-1 Steel Fix	81661805	0.71 – 0.79	0.94	2.32	0.94 in (24 mm)
STF 22-1 Steel Fix	81661806	0.79 – 0.87	1.02	2.40	0.94 in (24 mm)
STF 26-1 Steel Fix	81661807	0.87 – 1.02	1.18	2.76	0.94 in (24 mm)
STF 30-1 Steel Fix	81661808	1.02 – 1.18	1.34	2.91	0.94 in (24 mm)
STF 34-1 Steel Fix	81661809	1.18 – 1.34	1.50	3.07	0.94 in (24 mm)
STF 38-1 Steel Fix	81661810	1.34 – 1.50	1.65	3.23	0.94 in (24 mm)
STF 42-1 Steel Fix	81661811	1.50 – 1.65	1.81	3.58	0.94 in (24 mm)
Double bow clamp (for 2 cables)					
STF 12-2 Steel Fix	81661821	0.24 – 0.47	0.63	2.87	0.94 in (24 mm)
STF 14-2 Steel Fix	81661822	0.47 – 0.55	0.71	2.91	0.94 in (24 mm)
STF 16-2 Steel Fix	81661823	0.55 – 0.63	0.79	3.23	0.94 in (24 mm)
STF 18-2 Steel Fix	81661824	0.63 – 0.71	0.87	3.39	0.94 in (24 mm)
STF 20-2 Steel Fix	81661825	0.71 – 0.79	0.94	3.58	0.94 in (24 mm)
STF 22-2 Steel Fix	81661826	0.79 – 0.87	1.02	3.74	0.94 in (24 mm)
STF 26-2 Steel Fix	81661827	0.87 – 1.02	1.18	4.25	0.94 in (24 mm)
STF 30-2 Steel Fix	81661828	1.02 – 1.18	1.34	4.76	0.94 in (24 mm)
STF 34-2 Steel Fix	81661829	1.18 – 1.34	1.50	5.08	0.94 in (24 mm)
Triple bow clamp (for 3 cables)					
STF 12-3 Steel Fix	81661841	0.24 – 0.47	0.63	3.86	0.94 in (24 mm)
STF 14-3 Steel Fix	81661842	0.47 – 0.55	0.71	3.86	0.94 in (24 mm)
STF 16-3 Steel Fix	81661843	0.55 – 0.63	0.79	4.13	0.94 in (24 mm)
STF 18-3 Steel Fix	81661844	0.63 – 0.71	0.87	4.37	0.94 in (24 mm)
STF 20-3 Steel Fix	81661845	0.71 – 0.79	0.94	4.65	0.94 in (24 mm)
STF 22-3 Steel Fix	81661846	0.79 – 0.87	1.02	5.12	0.94 in (24 mm)

* Total height with max. cable diameter, including C-rail



Appendix















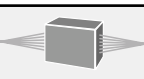

Protection classes EN 60529

An important element for housings is protection of integrated elements against drilling, foreign particles and water. The various protection properties are divided into IP classes (IP = international protection). The framework conditions that a protection class must guarantee are laid out in DIN 40050 and IEC-EN 60529.

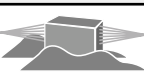
IP protection classes are indicated through a two digit code (IPXX). The first digit indicates protection against contact and foreign particles, the second the water protection factor.

Accordingly the class IP65 is completely protected against contacts, dustproof (1st digit = 6) and is protected against jets of water from a nozzle in all directions (2nd digit = 5).

First index number	Contact protection	Foreign particle protection	Second index number	Brief description	Water protection
0	No protection		0	No protection	
1	Protected against solid foreign objects of 1.97 in (50 mm) and larger	The object probe, a sphere of 1.97 in (50 mm) in diameter, must not fully penetrate. 	1	Protected against vertical falling drops of water	Drops which fall vertically must not have any harmful effect. 
2	Protected against solid foreign substances of 0.49 in (12.5 mm) diameter and above.	The object probe, a sphere of 0.49 in (12.5 mm) in diameter, must not fully penetrate. 	2	Protected against diagonally falling (up to 15°) drops of water	Drops which fall vertically must not have any harmful effects if the housing is inclined at an angle of up to 15° at either side of the perpendicular. 
3	Protected against solid foreign substances of 0.10 in (2.5 mm) diameter and above.	The object probe of diameter 0.10 in (2.5 mm) must not penetrate at all. 	3	Protected against diagonally falling spray (up to 60°)	Water which is sprayed at an angle of up to 60° from either side of the perpendicular must not have any harmful effects. 
4	Protected against solid foreign substances of 0.04 in (1.0 mm) dia. and above.	The object probe of diameter 0.04 in (1.0 mm) must not penetrate at all. 	4	Protected against spray from all directions	Water splashing against the enclosure from one direction shall have no harmful effect. 
5	Dust-protected	The ingress of dust is not fully prevented; however, it must not penetrate to such an extent that satisfactory operation or safety are impaired. 	5	Protected against jets of water (nozzle)	Water which is sprayed in a jet against the housing from any direction must not have any harmful effects. 
6	Dust-tight	No ingress of dust. 	6	Protected against strong water jets (flooding)	Water projected in powerful jets from any direction against the housing shall have no harmful effects. 
			7	Protected against the effect of temporary submersion in water	Water must not penetrate to an extent that will cause harmful effects, if the housing is temporarily submerged in water, under pressure and under time conditions. 
			8	Protected against the effect of permanent immersion in water	Water must not penetrate to such an extent that it will cause harmful effects if the housing is permanently submerged in water. 
			9k	Protection against highly pressurised water/steam jet cleaning	IP x9K according to DIN 40050 Water jet at 0°, 30°, 60° and 90° Cycle: 30 seconds each Distance: 3.94 - 5.91 in (10 - 15 cm) Water volume: 14 - 16 litres per min. Water temperature: 176 °F +/- 5 °F Water pressure: 80-100 bar 

Description of fire classifications according to UL 94



Fire classification HB

The material burns slowly in the horizontal combustion test. The rate of combustion must not exceed 3 inch/min. for wall thicknesses of up to 3 mm, and 1.5 inches/min. for wall thicknesses over 3 mm. Any materials exceeding these combustion rate limits are not registered by UL.



Fire classification V2

In the vertical combustion test, self-extinguishing must occur after an average of 25 seconds (individual values not to exceed 30 seconds). Any dripping material may ignite cotton wool located underneath. However, any afterglow must not exceed 60 seconds.



Fire classification V1

In the vertical combustion test, self-extinguishing must also occur after an average of 25 seconds (individual values not to exceed 30 seconds). However, any possible dripping material must not ignite the cotton wool. Any afterglow must not exceed 30 seconds.



Fire classification V0

In the vertical combustion test, self-extinguishing must occur after an average of less than 5 seconds (individual values not to exceed 10 seconds). Any material dropping off must not ignite cotton wool placed underneath and any afterglow must not exceed 30 seconds.

Description of fire classifications according to DIN 5510



Combustion class S4

Test procedure: acc. to DIN 54837

Requirements:

- Length of the destroyed area: ≤ 7.87 in (20 cm)
- No afterburning

Products may also be assigned to combustion class S4 if afterburning occurs within the burnt testing area and the average duration of afterburning does not exceed 10 seconds. If afterburning occurs in the undamaged area of the

test piece, the product must not be assigned to combustion class S4.

Products must not be assigned to combustion class S4 if an afterburning time of more than 120 seconds is observed for a test specimen.

Material characteristics



Burning behaviour

The flame-retardant properties of Murrplastik cable drag chains meet various classifications:

Test procedures acc. to VDE 0304 Parts 3/5.70

Classification: IIc

Testing based on "UL 94 – Standard Tests for Flammability of Plastic Materials for Parts in Devices and Appliances"

Classification: 94 HB with a 3.2 and 1.6 mm body thickness

Tested acc. to DIN 4102 "Fire behaviour of building materials and elements"

Classification: Materials class B 2

In case of more stringent applications please contact us.



Radiation resistance

Murrplastik cable drag chains are very resistant to high-energy radiation. In the range of 8×10^6 Gy gamma radiation, the mechanical properties change very little.

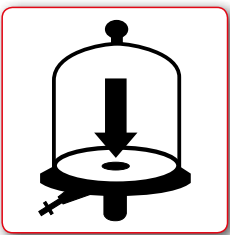

Vacuum

Murrplastik plastic cable drag chains may be safely used in a vacuum. Gas will only be given off in very low amounts.

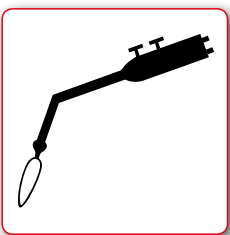

Welding flashes and hot sparks

For cables on robotic welding machines, Murrplastik cable drag chains offer the best line protection possible. This has been demonstrated both in laboratory testing and numerous references. The material may appear optically impaired but in no way will its function be reduced. Murrplastik cable drag chains have successfully passed tests involving medium-sized hot metal swarf at 500 °C.



Use in EX explosion proof areas

The Murrplastik cable drag chain may be used in explosion proof areas if manufactured to specification with a special material and if the standard regulations are observed. All Murrplastik cable drag chains are certified in accordance with ATEX European Directive 94/9 EC and can therefore be used in the relevant areas without hesitation.



Weatherproof

Murrplastik cable drag chains are suitable for outdoor applications. Experience has shown that the mechanical properties are not impaired.



Use in clean rooms

Murrplastik uses a special material. This reduces even further the very low wear of a normal chain. In many applications in which difficult special conditions apply, the cable drag chain can still be used. An intensive test program can be set up to verify its suitability in self-supporting and gliding applications.

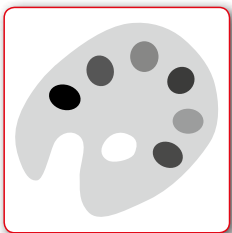

Special colours

Cable drag chains can be supplied in colours other than black on request. Several colours can also be combined where colour-psychological effects are desired. Minimum order quantities and special prices apply.



Use in cold storage

A special material is used for cold storage resistant cable drag chains.

Parts made of plastic / standard material



Murrplastik cable drag chains have been developed for use in extreme conditions. The standard material is glass fibre reinforced plastic in standard black.

Properties

The PA (polyamide) we have developed meets stringent requirements for high mechanical capability regarding strain, pressure, torsion and free running. For specific, problematic scenarios (e.g. clean-room applications, specific climatic requirements, deployment in hygienically demanding environments), we draw on our long-standing experience to offer modified materials and can hence offer a solution to match almost any scenario.

The cable drag chain plastic is free of halogens, silicones and hard metals such as lead and cadmium. No formaldehydes are used in manufacturing.

Mechanical properties		Test	Test value	Unit
Tensile strength (DIN 53 455)		dry	190	N/mm ²
		humidity	120	N/mm ²
Crack resistance (DIN 53 455)		dry	4	%
		humidity	6	%
Elasticity module	Tensile test	dry	7000	N/mm ²
		humidity	10000	N/mm ²
Impact resistance (DIN 53 455)	73 °F (23 °C)	dry	60	kJ/m ²
	73 °F (23 °C)	humidity	75	kJ/m ²
	-40 °C	dry	50	kJ/m ²
Creep module E	73 – 122 °F (23 – 50 °C)	humidity	5400	N/mm ²
	248 °F (120 °C)	dry	2100	N/mm ²
Heat conductivity			0.3	W/k x m
Static electricity value (DIN 53 455)		dry	3.8	MHz
		humidity	6.8	MHz
Special volume resistance		dry	10 ¹⁵	Ω x cm
		humidity	10 ¹²	Ω x cm
Impact resistance	Thickness 0.6 ... 0.8 mm		80	kV/mm
Surface resistance ROA		dry	10 ¹²	Ω
		humidity	10 ¹⁰	Ω
Moisture absorption	73 – 77 °F (23 – 25 °C)		1.8±0.2	%
Temperature limits				
	permissible temperature	-22 – 212 °F (-30 – 100 °C)		
	5000 hours	up to 275 °F (135 °C)		
	several hours	up to 338 °C (170 °C)		
Other properties				
Density	dry	1.4 g/cm ²		
Coefficient of sliding friction	unlubricated	0.3–0.45		
Combustion profile	DIN VDE 0304 Part 3			
Fire classification acc. to UL	HB			

Parts made of metal / standard material

The advantage of using light metal for certain parts lies in the combination of its mechanical strength, resistance to chemical attack and its physical properties.



Murrplastik use a special aluminium alloy with the following properties. It stands out due to the following characteristics:

- Light, stable, hard and smooth
- Visually appealing
- Very low friction and wear profile for this light metal against cabling materials
- No tendency to become brittle at low temperatures
- Brine-resistant

Aluminium is used by Murrplastik for the following products: Cross member profiles and profiles for variable guide channel system VAW.

Directives: What's meant by these abbreviations?

The use of specific materials in vehicles, as in electric and electronic devices, is restricted and/or forbidden by a set of European directives. Various associations and fabricators have published their own lists of materials considered undesirable.

RoHS-Directive 2002/95/EG (RoHS = Restriction of the use of certain Hazardous Substances in electrical and electronic equipment)

The guidelines limiting specific hazardous materials in electric and electronic devices categorised the following materials and their compounds as dangerous: lead, mercury, cadmium, chrome 6, polybrominated biphenyl (PBB) and polybrominated diphenyl ether (PBDE).

VDA Lists (VDA = Verband der Automobilindustrie in Deutschland, German Automotive Industry Association)

Alongside the legal stipulations, there are also a variety of material and declaration lists prescribed by various associations and fabricators. They contain materials and material groups that are undesirable or forbidden from the corresponding process-

ing branch for a variety of reasons. Several of the most well-known lists are shown in the following, their content drawn from other sources and in some cases expanded: VDA list 232-101 for notifiable materials; Bosch Standard N 2580. The VDA list is part of the ILRS list ("List for materials in automobile manufacture requiring declaration--substances in components and raw materials") that is used in the IMDS (International Material Data System).

ELV Directive 2000/53/EC
(ELV = End-of-Life Vehicles)

The heavy metals listed in the ordinance (ELV) are a portion of those named in the RoHS guidelines, including lead, mercury, cadmium, chrome 6.

WEEE Directive 2002/96/EC (WEEE = Waste from Electric and Electronic Equipment)

Goal of the guidelines is the avoidance of waste from electric and electronic devices, as well as their recovery and recycling. They require selective handling of used devices with specific critical materials, as named in the guideline appendices.

Chemical resistance of plastics

Reagent	Concentration %	At + °F	Polyethylene PE	Polyamide PA6	Polyamide PA 12	Polypropylene PP	Polyurethane PU
Acetaldehyde	100	68	+	40% o	+		+
Acetic acid	10	68	+	o	o	+	o
Acetone	100	68	+	+	+	+	-
Allyl alcohol	96	68		30% o	o	+	-
Alum, aqueous	diluted	104			+	+	
Aluminium chloride, aqueous	diluted	104	+		+	+	+
Aluminium sulphate, aqueous	diluted	104	+			+	+
Ammonia, aqueous	any	68	+	20% +		+	o
Ammonium chloride, aqueous	any	140	+		o	+	+
Ammonium nitrate, aqueous	diluted	104	+			+	+
Ammonium sulphate, aqueous	diluted	104	+			+	+
Aniline chlorohydrate, aqueous	saturated	68					
Aniline, pure	100	68	+	o	o	+	-
Benzaldehyde, aqueous	0.3	68	-	pure o	o	+	
Benzene	100	68	-	+	+	o	+
Benzoic acid	any	104	+		o	+	+
Benzol	100	68	-	+	+	o	-
Bleaching lye	12.5 Cl	68		-	o	o	
Boracic acid, aqueous	diluted	104	+	o	+	+	-
Borax, aqueous	diluted	104		o	+	+	
Boron	50	104		o			
Bromine, liquid	100	68	-	-	o	-	-
Butane diol	10	68		pure +		+	o
Butanol	100	68				+	+
Butyl acetate	100	68				o	-
Butyl alcohol	100	68	-			+	o
Calcium chloride, aqueous	any	104	+	+	o	+	+
Calcium nitrate, aqueous	50	104	+			+	+
Carbon bisulphide	100	68	-	o	+	+	+
Carbon dioxide	100	140	+			+	+
Carbon oxide	100	140	+			+	+
Carbon tetrachloride	100	68		+	o	o	+
Caustic potash solution	50	68		50% +		+	o
Chlorine	any	68	-	-	-	-	-
Chromic alum, aqueous	diluted	104				+	
Citric acid	10	104	+			+	o
Copper chloride, aqueous	saturated	68	+			+	+
Copper sulphate, aqueous	any	104	+			+	+
Cresol, aqueous	90	68	-	pure -	-	+	-
Crystallisable acetic acid	100	68			o	+	
Cyclohexanol	100	68		+		+	-
Ethyl acrylate/acrylic resin lacquer	100	68	-	30% -	-		
Ethyl alcohol, aqueous	10	68		o		+	+
Ethyl ether	100	68		30% +		o	-
Ethylene chloride	100	68				o	-
Ethylene oxide, liquid	100	68					
Exhaust gases containing carbon dioxide	any	140				+	+
Exhaust gases containing carbon oxide	any	140				+	+
Fluorine	50	104		-			
Formaldehyde, aqueous	diluted	104	+	pure +	o	+	o
Formic acid, aqueous	100	68		10% o	-	+	-

The information provided above enables an initial choice to be made. However, it is not intended as a guarantee of particular properties of the products or their suitability for a particular application. It does not release the buyer from the duty of carrying out suitability checks.

Reagent	Concentration %	At + °F	Polyethylene PE	Polyamide PA6	Polyamide PA 12	Polypropylene PP	Polyurethane PU
Glucose, aqueous	any	68	+			+	+
Hydrobromic acid, aqueous	10	104	+	-		+	-
Hydrochloric acid	10	86-104					
Hydrochloric acid, aqueous	10	68	+	20%	o	+	-
Hydrogen	100	140		+			+
Hydrosilicofluoric acid	30	68	-				
Hydroxylamine sulphate, aqueous	12	35					+
Iron chloride, aqueous	10	104	+	o	+	+	+
Lactic acid, aqueous	50	68	o	pure	+	+	o
Magnesium carbonate	any	68					+
Magnesium chloride, aqueous	any	68	+	10%	o	+	+
Mercury		140	+	+	+	+	+
Methyl alcohol	100	68	+			+	o
Methyl chloride	100	68					
Methylene chloride	100	68		o	o	-	-
Nickel chloride, aqueous	any	68		10%	o	+	+
Nickel sulphate, aqueous	any	68	+	10%	o	+	+
Nitric acid, aqueous	6	68	+	50%	-	-	+
Nitroglycerine	diluted	68					
Oils and greases		68	o	+	+	+	+
Oleic acid	100	68		+		+	o
Oxalic acid	saturated	68	+	10%	o	+	o
Ozone	100	68	o	o	+	o	o
Petroleum							+
Phosgene, liquid	100	68					-
Phosphoric acid, aqueous	diluted	68	+	10%	-	o	+
Phosphorus pentoxide	100	68				+	
Photographic developer		104				+	
Potash, aqueous	saturated	104			+		+
Potassium bromide, aqueous	any	140	+	10%	+	+	o
Potassium chloride, aqueous	any	68	+	10%	+	+	+
Potassium dichromate, aqueous	40	68				+	+
Potassium ferrocyanide, aqueous	any	140	o			+	
Potassium nitrate	any	68	+	10%	+	+	+
Potassium permanganate, aqueous	6	68	+		o	+	-
Potassium persulphate, aqueous	diluted	104	-		+	+	+
Salt solution	any	104			+	+	+
Seawater		104	+	+	o	+	+
Soap solution, aqueous	concentrated	68		o		+	+
Soda lye, aqueous	10	68	+	+	+	+	o
Sodium chlorate, aqueous	any	68	+	10%	o	+	
Sodium sulphide, aqueous	diluted	104				+	
Sulphuric acid	10	68	+	40-80%	-	o	+
Tin chloride, aqueous	diluted	104			+	+	+
Toluene	100	68	-	+	+	o	+
Trichloroethylene	100	68	-	o		o	-
Urea, aqueous	10	104		20%	+	+	+
Vinyl acetate	100	68					-
Xylene	100	68		+	+	o	+
Zinc chloride, aqueous	diluted	140	+	10%	o	o	+
Zinc sulphate, aqueous	diluted	140	+			+	+

+ means: resistant
o means: limited resistance
- means: not resistant

