



Component Systems

for Lighting Applications



UPDATE!
Edition 2017-1

For Discharge Lamps

Ballasts, Control Gear Units,
Ignitors, Power Switches,
Capacitors and Lampholders

For Fluorescent Lamps

Ballasts, Capacitors, Lampholders,
Starter Lampholders, Terminal
Blocks and Accessories

For Incandescent Lamps

Transformers and Lampholders

For Emergency Lighting

Emergency lighting modules,
Rechargeable Batteries and
Supports

1	Vossloh-Schwabe Projects	4–5
2	Ballasts for Discharge Lamps	6–39
	Electronic ballasts, accessories	8–12
	Luminaire protection device SP 230/10K	12
	Control gear units for HS and HI lamps	13–15
	Electromagnetic ballasts	16–39
	For HS and HI lamps	16–30
	For HM and HI lamps	31–33
	For power reduction	34–39
2	Ignitors and Accessories for Discharge Lamps	40–60
	Electronic superimposed ignitors	42–50
	Pulse ignitors	51–52
	Instant restrike ignitors	53–54
	Electronic power switches	55
	Electronic superimposed ignitors with power switch	56
	Switch units for electronic operating devices with 1–10 V interface	57
	Start-up switches	58–59
	Electronic discharge units	60
2	Lampholders for Discharge Lamps	62–79
	E27 lampholders	64–66
	E40 lampholders	67–68
	G8.5 lampholders	69
	GU6.5 lampholders	69
	GX10 lampholders	70
	GY9.5 lampholders	71
	G12 lampholders	71
	RX7s lampholders	72–75
	Fc2 lampholders	75–76
	K12x30s lampholders	77
	K12s-7 support	77
2	Technical Details for Discharge Lamps	78–119
3	Electronic Ballasts for TC and T Lamps	122–144
	For compact fluorescent lamps	122–135
	ELXc – Warm start – Linear casing shape	122
	ELXd – Dimmable – Linear casing shape	123–124
	ELXc – Warm start – Compact casing shape	125–130
	ECO EffectLine	131
	ELXd – Dimmable – Compact casing shape	132–135
	For tubular fluorescent lamps	136–143
	ELXc – Warm start – Linear casing shape	136–140
	EffectLine and EffectLine II	138
	New T5 EffectLine	139
	ECO EffectLine	140
	ELXd – Dimmable – Linear casing shape	141–143
	Accessories for dimmable electronic built-in ballasts	144
3	Electromagnetic ballasts for TC and T Lamps	146–155
	For compact fluorescent lamps	148–151
	Standard ballasts	148–151
	For tubular fluorescent lamps	152–155
	Super low-loss ballasts	152
	Standard ballasts	153–155
3	Lampholders and Accessories for TC Lamps	156–171
	G24, GX24 lampholders	158–162
	2G7 lampholders	163
	G23 lampholders	164–166
	GR10q lampholders	166–167
	2G10 lampholders	167
	2G11 lampholders	168
	Accessories	169–171
	GX53-1 lampholders, accessories	171
3	Lampholders and Accessories for T Lamps	174–197
	G5 lampholders	174–180
	G5 lampholders, accessories	174–178
	G5 twin lampholder	178
	G5 lampholders, degree of protection	
	IP54/IP65/IP67	179–180
	Lamp supports for lamps T-R5	180
	G13 lampholders	181–197
	G13 push-through lampholders	181–185
	G13 push-fit lampholders	183–185
	G13 push-fit twin lampholders, accessories	186–187
	G13 built-in lampholders	187–190
	G13 surface-mounted lampholders	191
	Accessories for T8 and T12 lamps	192–193
	G13 lampholders, degree of protection	
	IP54/IP65/IP67, accessories	194–197
3	Starter Holders and Terminal Blocks, Accessories	198–207
	Starter holders, accessories	200–203
	Terminal blocks, accessories	204–206
	Built-in rocker switches	207
3	Technical Details for Fluorescent Lamps	208–235
4	Parallel Capacitors	236–251
	Parallel capacitors	238–241
	Technical details for parallel capacitors	242–251

5	Transformers for Low-voltage Halogen Incandescent Lamps	252–257	5	Technical Details for Incandescent Lamps	314–327
	Independent electronic converters	254			
	Electromagnetic safety transformers	255–257			
5	Lampholders for Low-voltage Halogen Incandescent Lamps	258–267	6	Emergency Lighting Modules for TC and T Lamps	328–339
	G4, GZ4, G5.3, GX5.3, G6.35, GY6.35 lampholders, accessories	260–261		Emergency lighting modules with self-diagnosis function	330–331
	G4 lampholders, GZ4 lamp connectors	261–263		Technical details for emergency lighting modules	332–339
	Lampholders with separate mounting spring for GU4 lamps	264	7	Components for UL Market	340–347
	GX5.3 lamp connectors	265		For discharge lamps	342–343
	GU5.3 lampholders	265		For fluorescent lamps	343–346
	Lampholders with separate mounting spring for GU5.3 lamps	266	8	General Technical Details	349–356
	G6.35, GY6.35 lampholders, GZ6.35 lamp connectors	267			
	G53 lamp connectors	267	9	Glossary	357–359
5	Lampholders for Mains Voltage Halogen Incandescent Lamps	268–277	10	Table of Reference Numbers and Approval Marks	360–372
	B15d, BA15d lampholders	268			
	G9 lampholders, accessories	268–270			
	GU10, GZ10 lampholders, accessories	271–272			
	R7s ceramic lampholders	273–275			
	R7s metal lampholders	275			
	Connection boxes	276			
	Connectors	277			
5	Lampholders for General-service Incandescent and Retrofit Lamps	278–313			
	E14 lampholders	280–288			
	E14 thermoplastic lampholders, one-piece and cover caps	280–284			
	E14 thermoplastic lampholders, three-piece	285–287			
	E14 metal lampholders, three-piece	287–288			
	E14 thermoplastic rocker switch lampholders	288			
	E27 lampholders	289–305			
	E27 thermoplastic lampholders, one-piece and cover caps	289–293			
	E27 renovation kit lampholders	294			
	E27 thermoplastic lampholders, three-piece	295–297			
	E27 porcelain lampholders	298–299			
	E27 metal lampholders, three-piece	300			
	E27 thermoplastic pull-switch lampholders	301–302			
	E27 metal pull-switch lampholders	302–303			
	E27 thermoplastic rocker switch lampholders	303–304			
	E27 festoon lampholders	304–305			
	B22d lampholders, accessories	305–306			
	Accessories for E14, E27 and B22d lampholders	307–312			
	E40 porcelain lampholders	313			

LIGHT TECHNOLOGY PRODUCTS



Vossloh-Schwabe is not merely a manufacturer of top-quality components for the lighting industry, but above all a competent and innovative partner when it comes to providing the growing lighting market with cost-effective all-round solutions.

Featuring a future-proof component structure that already now satisfies both the requirements of energy-efficient lighting and European standards, VS' unique product range includes magnetic and electronic ballasts, state-of-the-art control systems (LiCS), LED lighting systems and matching operating devices.

Employing in excess of 1,000 people in more than 20 countries, Vossloh-Schwabe is represented all over the world. As a subsidiary of the Japanese Panasonic Group, VS can draw on extensive resources for R&D as well as for international expansion activities. A highly motivated workforce, comprehensive market knowledge, profound industry expertise as well as eco-awareness and environmental responsibility show Vossloh-Schwabe to be a reliable partner for the provision of optimum and cost-effective lighting solutions.

Vossloh-Schwabe's dedication to delivering superior quality is reflected in its ISO 9001 certification.

Vossloh-Schwabe is ready to embark on a collaborative journey into an economically illuminated future.

LED components are just as much a part of our product range as light control systems. Our extensive range of powerful LED modules, LED drivers, LiCS controllers and sensors is presented in our separate **Innovative Systems** catalogue.

We'll be happy to help you dimension your lighting project. Contact us.





PUMA Headquarters



Porsche Museum

1

2

3

4

5

6

7

8

9

10

PUMA Headquarters, Herzogenaurach

As the secret "capital of sport", the little German town of Herzogenaurach is home to the headquarters of the sport lifestyle company PUMA. Covering a total surface area of 50,000 square metres, the complex is made up of three buildings that are positioned so as to create a large central square, the PUMA Plaza.

The main aim of the lighting concept developed for the new PUMA corporate headquarters was to deliver optimum quality of light, enable maximum flexibility in using the available space and yield the greatest possible energy savings. No less than 985 electronic DALI ballasts and 4,650 standard electronic ballasts made by Vossloh-Schwabe went into implementing the lighting system.

The inner courtyard features additional red and white effect lighting in the form of ground-level linear markings created using LEDs made by Vossloh-Schwabe. These LEDs enable digital lighting sequences to flow over the square. To complement the clear-cut, rectilinear forms that characterise the entire building complex, a number of slender light columns, made of square aluminium sections, were installed to round off the courtyard's stylish appearance.

Photos: Markus Bollen

Porsche Museum, Stuttgart

The name "Porsche" both stands for a long tradition of outstanding quality and the excitement of high-octane driving. The Porsche Museum in Stuttgart constitutes a fitting presentation venue that does the brand image every justice. The architectural flagship thus serves to make the "Porsche experience" available to everyone.

The lighting installed in the Porsche Museum forms a crucial element of the exhibition space created for around 80 vehicles. It was important to ensure every detail of these high-end cars was clearly visible. In this regard, direct and reflecting lighting had to be reduced to an absolute minimum so as to neither irritate visitors, nor detract from the brilliant gloss of the bodywork.

This forms another instance in which Vossloh-Schwabe products have helped to add to the enjoyment of each and every visitor. Built-in electronic ballasts and electronic DALI safety converters ensure flicker-free, efficient light.

ELECTRONIC AND ELECTRO- MAGNETIC

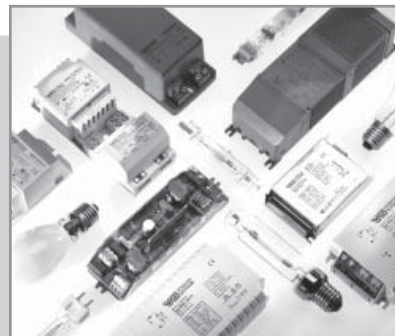

ELECTRONIC AND ELECTROMAGNETIC OPERATING DEVICES

For high-pressure sodium lamps (HS), metal halide lamps (HI) and mercury vapour lamps (HM)

Electronic ballasts

Modern discharge lamps operate very efficiently in combination with electronic ballasts. The numerous advantages of using electronic ballasts to operate high-pressure discharge lamps are listed in more detail on the product pages.

With the help of temperature and service-life tests, VS electronic ballasts guarantee a high degree of reliability. The quality of the electronic ballasts is ensured by continuous in-circuit tests and function tests like burn-in tests.

Magnetic ballasts

The electrical specifications of VS' range of ballasts comply with lamp-specific requirements. Vossloh-Schwabe attaches great importance to ensuring the impedance value of electromagnetic ballasts is kept within particularly narrow tolerances. This advantage, which is achieved by individual adjustment of the air gap during the automated production and testing process of every ballast, decisively contributes to optimising light output, light colour and service life of discharge lamps.

The range includes ballasts with variable voltage tapping points and varying degrees of inherent heating as well as encapsulated devices.



2

Ballasts for Discharge Lamps

For high-pressure sodium lamps (HS), metal halide lamps (HI) and mercury vapour lamps (HM)

Electronic ballasts, accessories

Luminaire protection device SP 230/10K

8-12

12

Control gear units for HS and HI lamps

13-15

Electromagnetic ballasts

For HS and HI lamps

For HM and HI lamps

For power reduction

16-39

16-30

31-33

34-39

Technical details for discharge lamps

General technical details

Glossary

79-119

348-356

357-359

1

2

3

4

5

6

7

8

9

10

Compact Electronic Ballasts for HI Lamps 35 W

Shape: K35

Casing: heat-resistant polyamide, encapsulated with polyurethane
 For ceramic discharge tube lamps (C-HI)
 Power factor: > 0.9
 Operation frequency: 135 Hz
 Push-in terminals: 0.5–1.5 mm²
 Constant power consumption
 Protection against "no load" operation
 For luminaires of protection class I and II
 Degree of protection: IP20
 Permissible load capacity: 120 pF
 RFI-suppressed
 Fixing brackets for screws M4 for base mounting
 No flickering of defective lamps

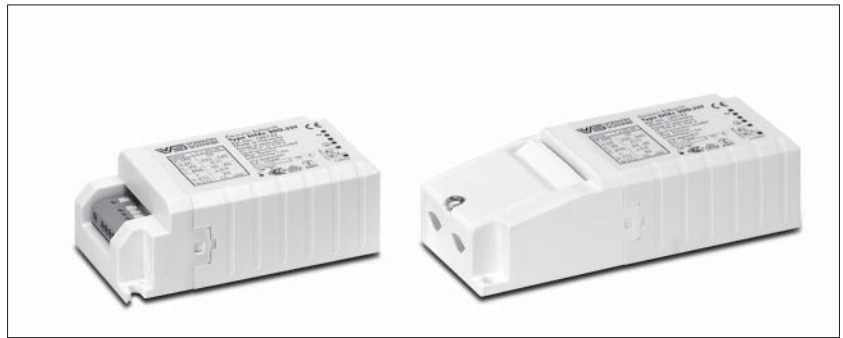

K35

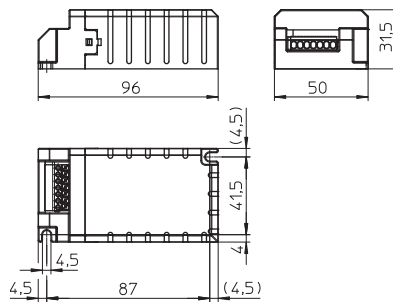

K35 with cord grip

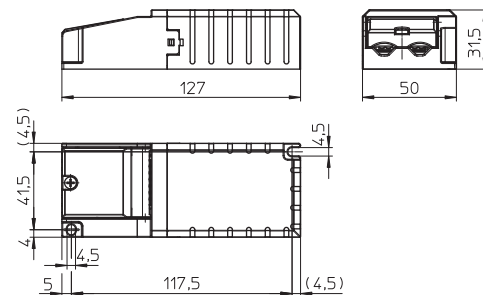

Lamp				Electronic ballast										System
Output	Type	Base	Power consumption	Type	Ref. No.	Voltage AC	Mains current	Energy efficiency	Ambient temperature	Casing temperature	Ignition voltage	Weight	Output	
W			W			50, 60 Hz	A		t _a (°C)	t _c (°C)	kV	g	W	
K35 – Electronic built-in ballasts														
35	HI	GU6.5, G8.5, GX8.5, GX10, G12	1 x 39	EHXc 35G.327 B	188993	220–240	0.2	A2	–15 to 45	max. 80	2–4	180	43.5	
K35 – Independent electronic ballasts with cord grip														
35	HI	GU6.5, G8.5, GX8.5, GX10, G12	1 x 39	EHXc 35G.327 I	188994	220–240	0.2	A2	–15 to 45	max. 80	2–4	195	43.5	

Circuit diagrams see page 87

Electronic Ballasts for HI Lamps 35 and 70 W

Shape: M3/K34

- Casing: aluminium (M3), heat-resistant polycarbonate (K34)
- For ceramic discharge tube lamps (C-HI)
- Power factor: ≥ 0.95
- Ignition voltage: max. 5 kV
- Operation frequency: 173 Hz
- Push-in terminals with lever opener: 0.75–2.5 mm²
- Total harmonic distortion: < 10%
- Temperature protection
- Constant power consumption
- Protection against "no load" operation
- For luminaires of protection class I (metal casing)
- For luminaires of protection class I and II (plastic casing)
- Degree of protection: IP20
- Permissible load capacity: 20–120 pF
- RFI-suppressed
- Fixing brackets for screws M4 for base mounting
- No flickering of defective lamps



M3

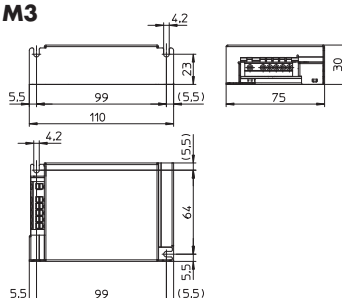

K34 with cord grip

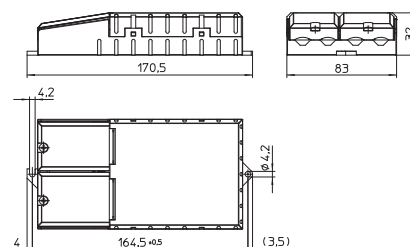

M3 built-in PCB

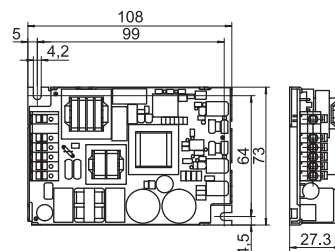

t_c point definition

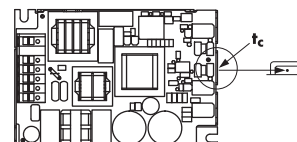

Lamp				Electronic ballast								System	
Output W	Type	Base	Power consumption W	Type	Ref. No.	Voltage AC 50, 60 Hz V ±10%	Mains current A	Energy efficiency	Ambient temperature t _a (°C)	Casing temperature t _c (°C)	Weight g	Output W	
M3 – Electronic built-in ballast (with cap)													
35	HI	GU6.5, G8.5, GU8.5, GX8.5, G12, E27	1 x 39	EHXc 35.325	183033	220–240	0.20–0.18	A2	–20 to 65	max. 80	220	43	
70	HI	G8.5, GU8.5, GX8.5, G12, PG12-2, E27, RX7s	1 x 73	EHXc 70.326	183036	220–240	0.36–0.34	A2	–20 to 55	max. 80	220	80	
M3 Built-in PCB – Electronic built-in ballasts (without cap)													
35	HI	GU6.5, G8.5, GU8.5, GX8.5, G12, E27	1 x 39	EHXc 35.325	183034	220–240	0.20–0.18	A2	–20 to 65	max. 80	180	43	
K34 – Independent electronic ballasts with cord grip													
35	HI	GU6.5, G8.5, GU8.5, GX8.5, G12, E27	1 x 39	EHXc 35.325	183035	220–240	0.20–0.18	A2	–20 to 65	max. 75	260	43	
70	HI	G8.5, GU8.5, GX8.5, G12, PG12-2, E27, RX7s	1 x 73	EHXc 70.326	183038	220–240	0.36–0.34	A2	–20 to 55	max. 75	260	80	

Circuit diagrams see page 87

Electronic Ballasts for HI Lamps 150 W

Shape: K31

Casing: heat-resistant polycarbonate
 For ceramic discharge tube lamps (C-HI)
 Power factor: 0.98
 Ignition voltage: max. 5 kV
 Operation frequency: 170 Hz
 Push-in terminals with lever opener: 0.75–2.5 mm²
 Total harmonic distortion: < 10%
 Temperature protection
 Constant power consumption
 Protection against "no load" operation
 For luminaires of protection class I and II
 Degree of protection: IP20
 Permissible load capacity: 20–240 pF
 RFI-suppressed
 Fixing brackets for screws M4
 for base mounting



K31

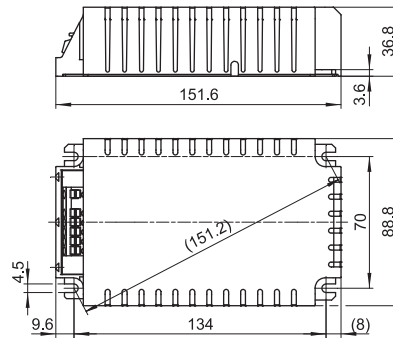

K31 with cord grip

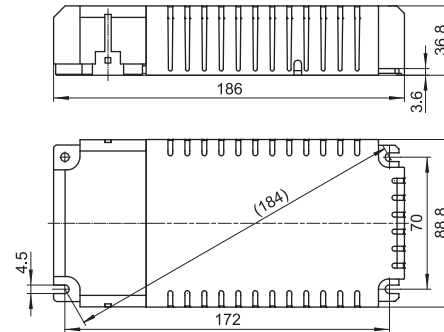

Lamp				Electronic ballast									System
Output W	Type	Base	Power consumption W	Type	Ref. No.	Voltage AC 50, 60 Hz V ±10%	Mains current A	Energy efficiency	Ambient temperature t _a (°C)	Casing temperature t _c (°C)	Casing	Weight g	Output W
K31 – Electronic built-in ballasts													
150	HI	G12, PGX12-2, E27, E40, RX7s	1 x 147	EHXc 150G.334	183046	220–240	0.73–0.67	A2	–20 to 45	max. 85	K31	540	160
K31 – Independent electronic ballasts with cord grip													
150	HI	G12, PGX12-2, E27, E40, RX7s	1 x 147	EHXc 150G.334	183047	220–240	0.73–0.67	A2	–20 to 45	max. 85	K31	582	160

Circuit diagrams see page 87

Cord Grip for Electronic Built-in Ballasts

For shape K31

By using the cord grip electronic built-in ballasts for metal halide lamps become independent ballasts.

Material: heat-resistant polycarbonate

For use with electronic built-in ballasts with casing K31

For mains leads:

H03VV-F 3X0.75 or NYM 3X1.5 mm²

For lamp leads: SIHY-Cu 3X1 mm²

or SIHSI-Cu 3X1 mm²

Weight: 50 g

Unit: 20 pcs.

By turning the cable clamp by 180° the lead diameter can be reduced to 5 mm.

Ref. No.: 188080

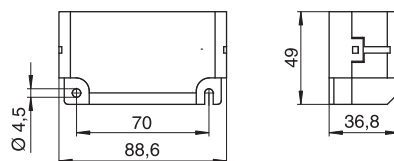
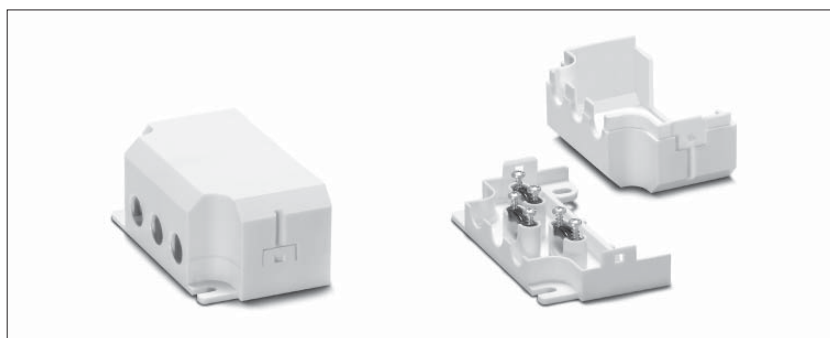

1

2

3

4

5

6

7

8

9

10

Luminaire Protection Device SP 230/10K

For electronic devices

When electronic components form part of lighting systems, it is often necessary to protect such components against power-supply interruptions and electric overloads (power surges).

These can be caused by switching inductive loads or by atmospheric discharges such as lightning striking the mains or the ground. A further cause can be induced voltages from neighbouring cables when working with leading-edge phase-cutting controls.

Suitable for luminaires of protection class I and II
Solid connecting wire: 0.75 mm²
Lead length: 50 mm

The SP230/10K protection unit reduces overvoltages at the connection terminals of electronic components. The remaining residual voltage is then reduced to a respective protective level, based on the discharge current (see diagram below).

In our Innovative Systems catalogue you will find further products of this series.



Wiring diagram

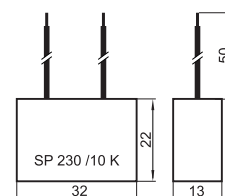
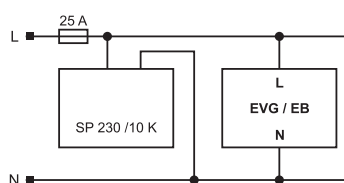

Type	Best.-Nr.	Voltage AC 50, 60 Hz V ±10%	Impulse voltage U _{OC} (V)	Impulse discharge current I _N (8/20 μs) (A)	Protection level at discharge current of 1,000 A (V)	Min. ambient temperature t _a (°C)	Casing temperature t _c (°C)	Weight g
SP 230/10 K	147230	220–240	max. 10,000	max. 10,000	≤ 850	–30	max. 80	20

Bandwidth of the standard impulse: tr = 20 μs
The protection unit can withstand at least 10 spikes
of 5 kA.

Residual voltage, based on the discharge current (B)

A = Leak current | B = Protection levels

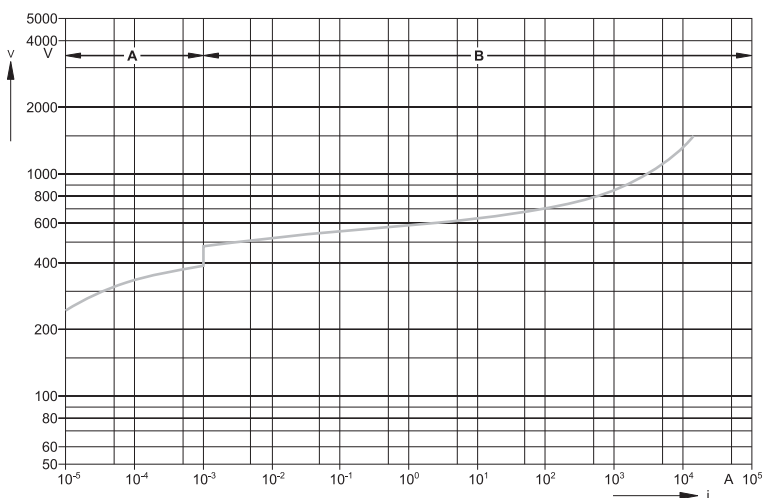

Source: Epcos Databook 2011

Control Gear Units for HS and HI Lamps 35 to 150 W

Compact plastic casing
Shape: 64x72 mm

For high pressure sodium lamps (HS), metal halide lamps (HI) and ceramic discharge lamps (C-HI)
Compact control gear unit with ballast with patented, intelligent thermal cut-out with automatic reset (which evaluates the temperature and current of the ballast), digital timer ignitor with IPP++ technology and compensation capacitor with thermal fuse

As individual components no longer need to be wired, there is a significant reduction in assembly time and costs.

Protection class II

Degree of protection: IP40

Permissible load capacity: 20–1000 pF

Lead length to the lamp: max. 10 m

tw 130

Push-in terminals: 0.5–2.5 mm²

Cord grips for mains and lamp leads

Further outputs and voltages on request

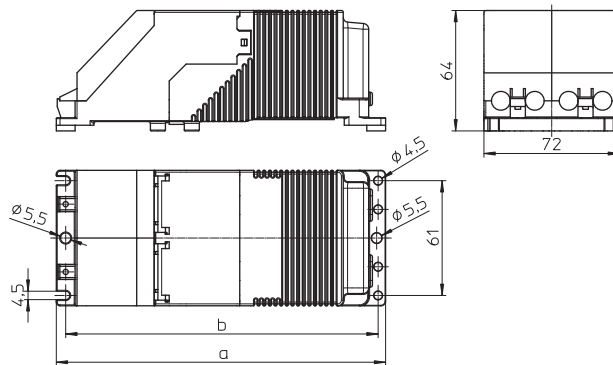

Lamp			Control gear unit									
Output W	Type	Current A	Type	Ref. No.	Voltage AC V, Hz	Mains current A	a mm	b mm	Weight kg	t_a °C	Power factor λ	Energy efficiency
230 V, 50 Hz												
35	HS, HI	0.53	VNaHJ 35PZTG.568*	536199	230, 50	0.210	175	166	1.32	55	0.92	EEI=A3
70	HS, HI	0.98	VNaHJ 70PZTG.203	563416	230, 50	0.380	214	205	2.25	45	0.91	A2
			VNaHJ 70PZTG.566*	535657	230, 50	0.380	175	166	1.32	45	0.91	EEI=A3
100	HS, HI	1.20	VNaHJ 100PZTG.202	563417	230, 50	0.560	214	205	2.25	45	0.85	A2
			VNaHJ 100PZTG.571*	536200	230, 50	0.560	214	205	1.85	45	0.85	EEI=A3
150	HS, HI	1.80	VNaHJ 150PZTG.567*	535695	230, 50	0.720	214	205	2.25	45	0.91	EEI=A3
240 V, 50 Hz												
35	HS, HI	0.53	VNaHJ 35PZTG.568	536201	240, 50	0.210	175	166	1.32	55	0.94	EEI=A3
70	HS, HI	0.98	VNaHJ 70PZTG.566	536202	240, 50	0.370	175	166	1.32	40	0.94	EEI=A3
100	HS, HI	1.20	VNaHJ 100PZTG.571	536203	240, 50	0.560	214	205	1.85	40	0.86	EEI=A3
150	HS, HI	1.80	VNaHJ 150PZTG.567	536204	240, 50	0.730	214	205	2.25	40	0.91	EEI=A3
220 V, 60 Hz												
35	HS, HI	0.53	VNaHJ 35PZTG.574	536205	220, 60	0.220	175	166	1.32	60	0.98	EEI=A3
70	HS, HI	0.98	VNaHJ 70PZTG.575	536207	220, 60	0.370	175	166	1.32	50	0.97	EEI=A3
150	HS, HI	1.80	VNaHJ 150PZTG.576	536209	220, 60	0.800	214	205	2.25	45	0.98	EEI=A3

* Ballasts without CE marking for replacements or markets outside of the EU

Control Gear Units IP65 for HS and HI Lamps 35 to 150 W

Encapsulated unit in compact plastic casing
Shape: 61x72 mm

For high pressure sodium lamps (HS), metal halide lamps (HI) and ceramic discharge lamps (C-HI)
 Compact control gear unit with ballast with patented, intelligent thermal cut-out with automatic reset (which evaluates the temperature and current of the ballast), digital timer ignitor with IPP++ technology and compensation capacitor with thermal fuse

As individual components no longer need to be wired, there is a significant reduction in assembly time and costs.

Protection class II

Degree of protection: IP65

Permissible load capacity: 20–1000 pF

Lead length to the lamp: max. 10 m

tw 130

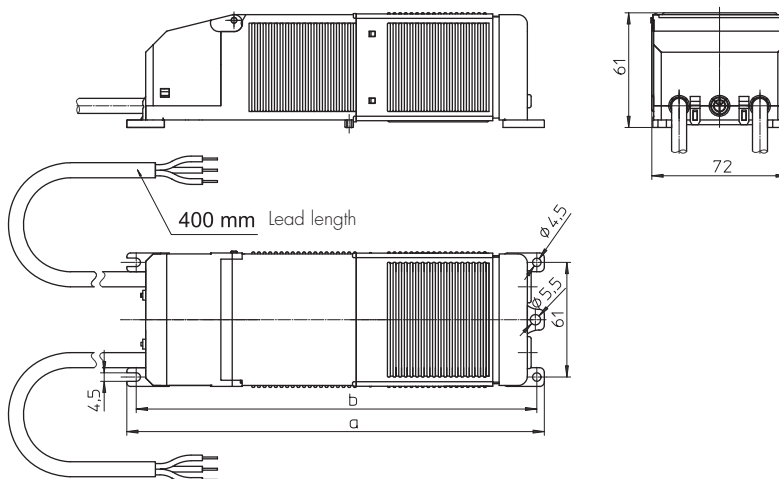

Lamp			Control gear unit									
Output W	Type	Current A	Type	Ref. No.	Voltage V, Hz	Mains current A	a mm	b mm	Weight kg	t _a °C	Power factor λ	Energy efficiency
230 V, 50 Hz												
35	HS, HI	0.53	VNaHJ 35PZTG.050*	533391	230, 50	0.240	222	214	1.95	60	0.96	EEI=A3
50	HS, HI	0.76	VNaH 50PZTG.058*	543733	230, 50	0.290	222	214	1.95	60	0.94	EEI=A3
70	HS, HI	0.98	VNaHJ 70PZTG.051*	533392	230, 50	0.370	222	214	1.95	50	0.97	EEI=A3
100	HS, HI	1.20	VNaHJ 100PZTG.078*	533393	230, 50	0.560	249	240	2.25	55	0.90	EEI=A3
150	HS, HI	1.80	VNaHJ 150PZTG.052*	533394	230, 50	0.740	249	240	2.75	50	0.94	EEI=A3
240 V, 50 Hz												
35	HS, HI	0.53	VNaHJ 35PZTG.053	534107	240, 50	0.240	222	214	1.95	60	0.96	EEI=A3
70	HS, HI	0.98	VNaHJ 70PZTG.054	534109	240, 50	0.370	222	214	1.95	50	0.97	EEI=A3
150	HS, HI	1.80	VNaHJ 150PZTG.055	534115	240, 50	0.730	249	240	2.75	50	0.95	EEI=A3
220 V, 60 Hz												
35	HS, HI	0.53	VNaHJ 35PZTG.041	534122	220, 60	0.220	222	214	1.95	70	0.98	EEI=A3
70	HS, HI	0.98	VNaHJ 70PZTG.067	534111	220, 60	0.370	222	214	1.95	50	0.97	EEI=A3
150	HS, HI	1.80	VNaHJ 150PZTG.068	534117	220, 60	0.800	249	240	2.25	45	0.98	EEI=A3

* Ballasts without CE marking for replacements or markets outside of the EU

Control Gear Units for HS and HI Lamps 250 and 400 W

Shape: 76x91 mm



For high pressure sodium lamps (HS),
metal halide lamps (HI) and
ceramic discharge lamps (C-HI)
Fully wired slim, weather-proof control gear unit
with ballast with thermal cut-out with automatic reset,
capacitor, timer ignitor and connection terminal
Suitable for installation in or on pylons
Frontal cable feed using a PG thread fitting
Front access to terminals
Screw-fixed end cap
Screw terminals: 0.75–2.5 mm²
For luminaires of protection class I
Degree of protection: IP54
Permissible load capacity: 20–1000 pF
Distance to the lamp: max. 10 m
tw 130
With connection for protective earth conductor

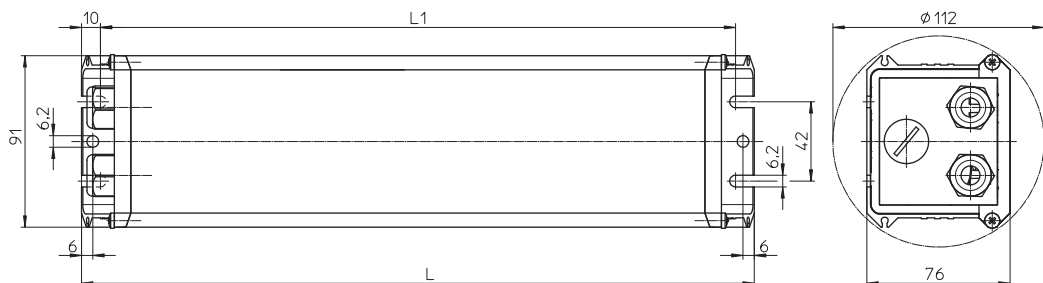

Lamp				Control gear unit							
Output W	Type	Current A	Mains current A	Type	Ref. No.	Voltage AC V, Hz	L mm	L1 mm	Weight kg	Power factor λ	Energy efficiency
250	HS, HI	3.0	1.3	VNaHJ 250PZT.745*	531476	230, 50	322	302	4.30	> 0.94	EEI=A3
400	HS, HI	4.45	2.0	VNaHJ 400PZT.743	531475	230, 50	357	337	5.62	> 0.91	A2

* Ballasts without CE marking for replacements or markets outside of the EU

Ballast Units for HS and HI Lamps 1000 and 2000 W

Shape: 114x116 mm

For high-pressure sodium vapour lamps (HS) and metal halide lamps (HI)
Slim, weather-proof ballast unit fully wired with ballast, capacitor and connection terminal
Suitable for installation in or on pylons
With connection for protective earth conductor
Frontal cable feed using a PG thread fitting
Front access to terminals or fuses
Optional additional third PG connection for mains feed-through wiring
Screw-fixed end cap
Diverse mounting options using an assembly plate or rail
Screw terminals: 0.75–10 mm²
For luminaires of protection class I
tw 130

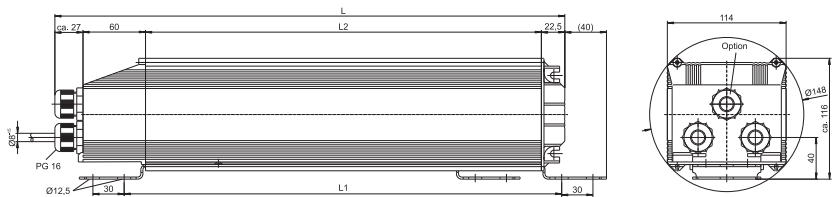

Degree of protection: IP54

Lamp				Ballast unit								
Output W	Type	Current A	Mains current A	Type	Ref. No.	Voltage AC V, Hz	L mm	L1 mm	L2 mm	Weight kg	Power factor λ	Energy efficiency
1000	HS	10.3	5.0	VNaHJ 1000.61	531472	230–240, 50	487	410	370	11.6	> 0.90	A2
	HI	9.5	4.9									A2
2000	HI	10.3	6.0	VJD 2000.63	531474	380–400, 50	627	550	510	20.2	> 0.90	A2

Degree of protection: IP65

Fully encapsulated ballast unit with leads

Lamp				Ballast unit								
Output W	Type	Current A	Mains current A	Type	Ref. No.	Voltage AC V, Hz	L mm	L1 mm	L2 mm	Weight kg	Power factor λ	Energy efficiency
1000	HS	10.3	5.0	VNaHJ 1000.61	531480	220, 50	487	410	370	11.6	> 0.90	A2
	HI	9.5	4.9									A2
2000	HI	10.3	6.0	VJD 2000.63	531481	380, 50	627	550	510	20.2	> 0.90	A2

Ballast Units for HS and HI Lamps 1000 to 2000 W

Encapsulated in a plastic casing

For high-pressure sodium vapour lamps (HS) and metal halide lamps (HI)
Fully encapsulated ballast unit in a self-extinguishing, fibre-glass-reinforced polyamide casing consisting of a ballast, capacitor, fuse and a ready-to-use, pre-wired connection terminal.
Cable feed using a PG thread fitting
Screw terminals: 0.75–10 mm²

Protection class II

tw 130

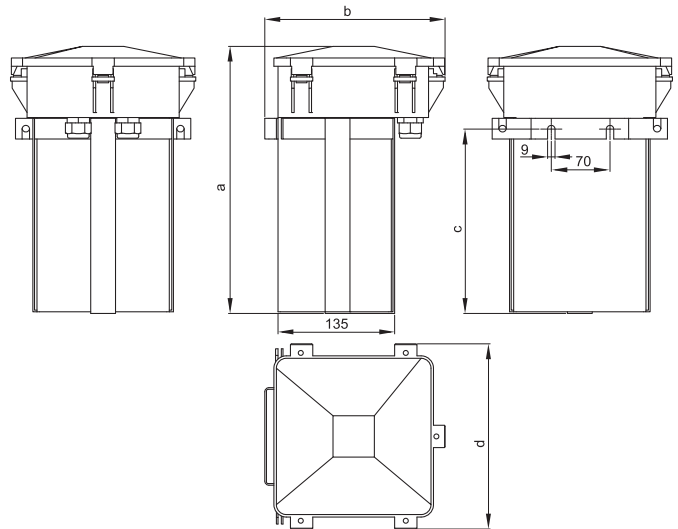

Degree of protection: IP65

With double insulation

Lamp				Ballast unit									
Output W	Type	Current A	Mains current (A)	Type	Ref. No.	Voltage AC V, Hz	a mm	b mm	c mm	d mm	Weight kg	Power factor λ	Energy efficiency
230/240 V, 50 Hz and 380/400/415 V, 50 Hz													
1000	HS	10.3/11.3	5.75	VNaHJ 1000.75	554313	230/240, 50	288	217	—	220	15	> 0.90	A2
	HI	9.5	4.9										A2
2000	HI	8.8/9.2	5.7	VJ 2000.76	554314	380/400/415, 50	320	217	225	225	21	> 0.90	A2
		10.3/11.3	6.0	VJD 2000.77	554315	380/400/415, 50	320	220	225	225	23	> 0.90	A2
		12.2	6.0	VJD 2000I.78	554316	380/400/415, 50	320	220	225	225	25	> 0.90	A2
220 V, 60 Hz and 380 V, 60 Hz													
1000	HS	10.3/11.3	5.75	VNaHJ 1000.75	554904	220, 60	288	217	—	220	15	> 0.90	A2
	HI	9.5	4.9										A2
2000	HI	8.8/9.2	5.7	VJ 2000.76	554905	380, 60	320	220	225	225	21	> 0.90	A2
		10.3/11.3	6.0	VJD 2000.77	554906	380, 60	320	220	225	225	23	> 0.90	A2
		12.2	6.0	VJD 2000I.78	554909	380, 60	320	220	225	225	25	> 0.90	A2

Compact Assembly Kits for HS and HI Lamps 35 to 150 W

Ballast shape: 53x66 mm

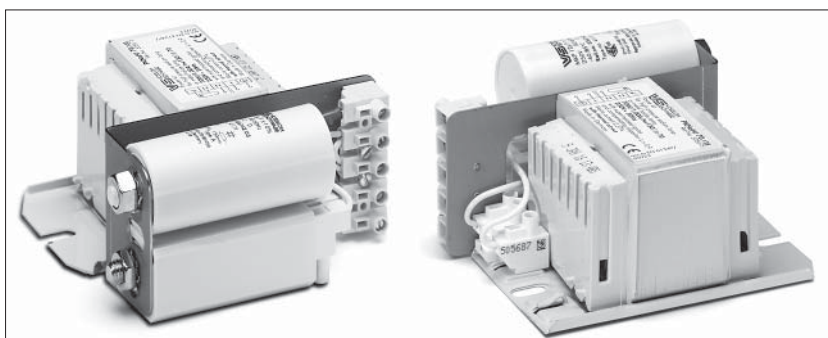

For high pressure sodium lamps (HS), metal halide lamps (HI) and ceramic discharge lamps (C-HI)
Compact assembly kit with ballast with or without patented, intelligent thermal cut-out with automatic reset (which evaluates the temperature and current of the ballast), super-imposed ignitor and compensation capacitor

With luminaire terminal block:
screw terminal 0.75–2.5 mm²

With earth terminal

Permissible load capacity: 20–100 pF

Lead length to the lamp: max. 1.5 m
tw 130

On request:

Further outputs and voltages

With digital timer ignitor

For pulse ignition system

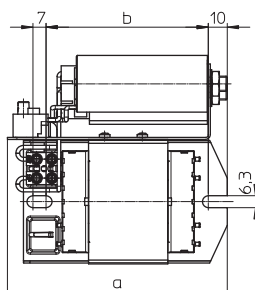
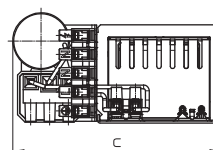
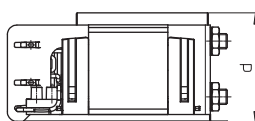

As individual components no longer need to be wired, there is a significant reduction in assembly time and costs.

Especially suitable for change of lamp technology from HM to HS.

Lamp			Assembly kit											
Output W	Type	Current A	Type	Ref. No.	Voltage AC V, Hz	Mains current A	Temperature protection	a mm	b mm	c mm	d mm	Weight kg	Power factor λ	Energy efficiency
230 V, 50 Hz														
35	HS, HI	0.53	PKNaHJ 35.008*	546797	230, 50	0.22	yes	117	86	108	54	1.2	> 0.90	EEI=A3
50	HS, HI	0.76	PKNaH 50PZT.992*	543378	230, 50	0.30	yes	117	86	111	59	1.4	> 0.90	EEI=A3
70	HS, HI	0.98	PKNaHJ 70.128*	538675	230, 50	0.37	yes	117	86	111	59	1.4	> 0.90	EEI=A3
				538685			no							EEI=A3
100	HS, HI	1.20	PKNaHJ 100.941*	538676	230, 50	0.56	yes	117	86	111	59	1.6	> 0.90	EEI=A3
				538686			no							EEI=A3
150	HS, HI	1.80	PKNaHJ 150.620*	538677	230, 50	0.74	yes	151	120	115	63	2.2	> 0.90	EEI=A3
				538687			no							EEI=A3
220 V, 60 Hz														
35	HS, HI	0.53	PKNaHJ 35.008	547285	220, 60	0.23	yes	117	86	108	54	1.2	> 0.90	EEI=A3
				543401			no							EEI=A3
70	HS, HI	0.98	PKNaHJ 70.653	547287	220, 60	0.37	yes	117	86	111	59	1.4	> 0.90	EEI=A3
				538680			no							EEI=A3
100	HS, HI	1.20	PKNaHJ 100.271	538681	220, 60	0.56	no	117	86	111	59	1.6	> 0.90	EEI=A3
150	HS, HI	1.80	PKNaHJ 150.679	538682	220, 60	0.74	no	151	120	115	63	2.2	> 0.90	EEI=A3
220/240 V, 60 Hz														
100	HS, HI	1.20	PKNaHJ 100.345	543295	220/240, 60	0.60	no	117	86	111	60	1.6	> 0.90	EEI=A3
150	HS, HI	1.80	PKNaHJ 150.301	543299	220/240, 60	0.80	no	151	120	115	63	2.2	> 0.90	EEI=A3

* Ballasts without CE marking for replacements or markets outside of the EU

Compact Assembly Kits for HS and HI Lamps 250 and 400 W

Ballast shape: 71x75 mm

For high pressure sodium lamps (HS), metal halide lamps (HI) and ceramic discharge lamps (C-HI)
Compact assembly kit with ballast with or without thermal cut-out with automatic reset, superimposed ignitor and compensation capacitor

With luminaire terminal block:

screw terminal 0.75–2.5 mm²

With earth terminal

Permissible load capacity: 20–100 pF

Lead length to the lamp: max. 1.5 m
tw 130

On request:

Further outputs and voltages

With digital timer ignitor

For pulse ignition system

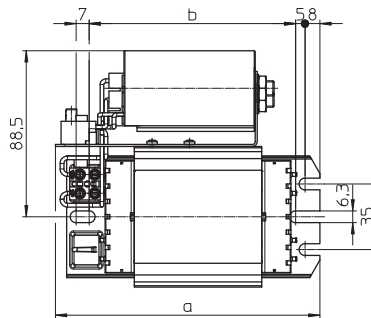
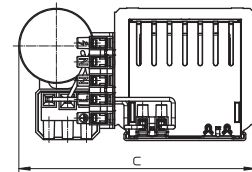
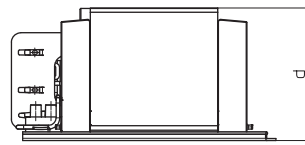
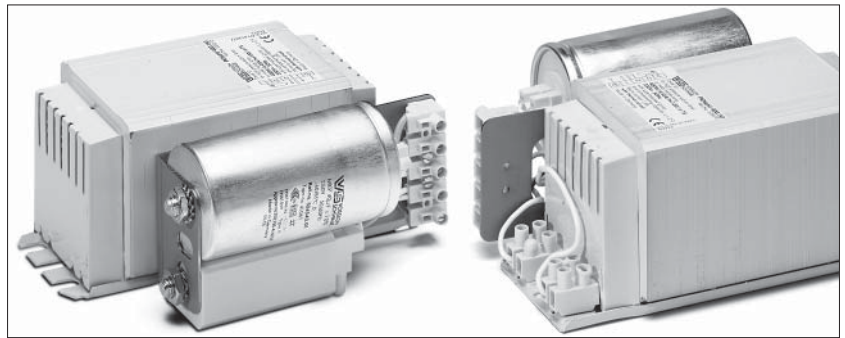

As individual components no longer need to be wired, there is a significant reduction in assembly time and costs.

Especially suitable for change of lamp technology from HM to HS.

Lamp			Assembly kit											
Output	Type	Current	Type	Ref. No.	Voltage AC	Mains current	Temperature protection	a	b	c	d	Weight	Power factor	Energy efficiency
W		A			V, Hz	A		mm	mm	mm	mm	kg	λ	
230 V, 50 Hz														
250	HS, HI	3.00	PKNaHJ 250.741	538678	230, 50	1.20	yes	141	110	128	73	3.2	> 0.90	A2
				538688			no							A2
400	HS, HI	4.45	PKNaHJ 400.743	538679	230, 50	1.80	yes	171	140	129	73	5.2	> 0.90	A2
				538689			no							A2
220 V, 60 Hz														
250	HS, HI	3.00	PKNaHJ 250.742	538683	220, 60	1.20	no	141	110	126	71	3.2	> 0.90	A2
400	HS, HI	4.45	PKNaHJ 400.744	538684	220, 60	1.80	no	171	140	129	71	5.2	> 0.90	A2

Standard Ballasts for HS and HI Lamps 35 to 70 W

Shape: 53x66 mm

For high pressure sodium lamps (HS),
metal halide lamps (HI) and
ceramic discharge lamps (C-HI)
Vacuum-impregnated with polyester resin
Screw terminals: 0.5–2.5 mm²
Protection class I
tw 130
Ballasts for pulse ignition system on request

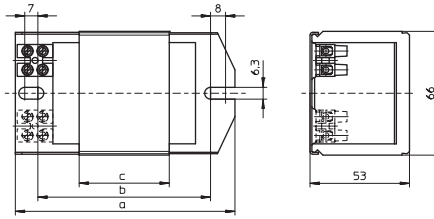
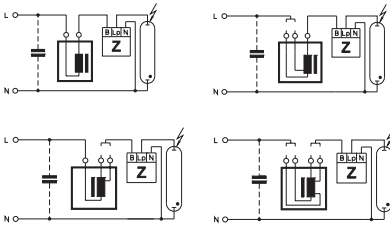
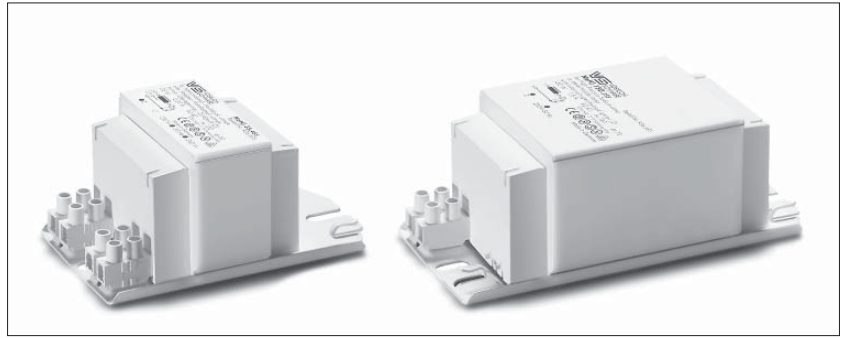

Lamp			Ballast										Capacitor	
Output W	Type	Current A	Type	Ref. No.	Voltage AC V, Hz	a mm	b mm	c mm	Weight kg	Δt K	Power factor λ	Energy efficiency	C _p μF	I _N A
35	HS, HI	0.53	NaHJ 35.485*	526517	220/230, 50	108	86	36	1.07	60	0.40	EEI=A3	6	0.22/0.21
			NaHJ 35.485*	161367	230/240, 50	108	86	36	1.07	60	0.40	EEI=A3	6	0.22/0.21
			NaHJ 35.638	161371	220, 60	108	86	36	1.07	50	0.41	EEI=A3	5	0.23
50	HS, HI	0.76	NaH 50.486*	161379	230/240, 50	108	86	36	1.07	65	0.37	EEI=A3	8	0.30/0.29
			NaH 50.654	161399	220, 60	108	86	36	1.07	60	0.36	EEI=A3	8	0.31
50	HS, HI	0.76	NaHJ 70/50.157*	160613	230, 50	108	86	42	1.23	55	0.37	EEI=A3	8	0.30
70	HS, HI	0.98									70	0.37	EEI=A3	12
70	HS, HI	0.98	NaHJ 70.300	174961	220, 50	108	86	36	1.07	75	0.40	EEI=A3	12	0.40
			NaHJ 70.128*	533568	230, 50	108	86	36	1.07	70	0.36	EEI=A3	12	0.38
			NaHJ 70.128*	539434	230/240, 50	108	86	36	1.07	70/75	0.36	EEI=A3	12	0.38/0.37
			NaHJ 70.158	161662	240, 50	108	86	42	1.23	70	0.36	EEI=A3	12	0.37
			NaHJ 70.128	538407	240, 50	108	86	36	1.07	75	0.37	EEI=A3	12	0.37
			NaHJ 70.653	161392	220, 60	108	86	36	1.07	60	0.42	EEI=A3	10	0.40

* Ballasts without CE marking for replacements or markets outside of the EU

Standard Ballasts for HS and HI Lamps 70 to 250 W

Shape: 53x66 mm

Lamp			Ballast										Capacitor	
Output W	Type	Current A	Type	Ref. No.	Voltage AC V, Hz	a mm	b mm	c mm	Weight kg	Δt K	Power factor λ	Energy efficiency	Cp μF	IN A
70	HS, HI	0.98	NaHj 100/70.703*	161469	230, 50	145	120	48	1.39	60	0.37	EEl=A3	12	0.38
100	HS, HI	1.20								70	0.43	EEl=A3	12	0.55
70	HS, HI	0.98	NaHj 100/70.519	161158	230/240, 50	145	120	75	2.03	50	0.36	A2	12	0.38/0.37
100	HS, HI	1.20								60	0.42	EEl=A3	12	0.55/0.53
70	HS, HI	0.98	NaHj 100/70.709	161471	220, 60	145	120	48	1.39	50	0.39	EEl=A3	10	0.40
100	HS, HI	1.20								60	0.44	EEl=A3	10	0.57
100	HS, HI	1.20	NaHj 100.126	507671	220, 50	108	86	42	1.24	75	0.44	EEl=A3	12	0.55
			NaHj 100.941*	161707	230/240, 50	108	86	42	1.24	75/80	0.42	EEl=A3	12	0.55/0.53
			NaHj 100.271	530195	220, 60	108	86	42	1.24	75	0.45	EEl=A3	10	0.57
150	HS, HI	1.80	NaHj 150.159	533602	220, 50	145	120	64	1.80	75	0.41	EEl=A3	20	0.80
			NaHj 150.620*	533565	230, 50	145	120	64	1.80	70	0.40	EEl=A3	20	0.77
			NaHj 150.620	534540	240, 50	145	120	64	1.80	75	0.40	EEl=A3	20	0.74
			NaHj 150.679	526196	220, 60	145	120	55	1.55	75	0.44	EEl=A3	16	0.80
			NaHj 150.679	537793	220, 60	117	92	55	1.55	75	0.44	EEl=A3	16	0.80
250	HS, HI	3.00	NaHj 250.204	529087	220, 50	160	135	95	2.50	80	0.42	EEl=A3	32	1.32
			NaHj 250.160	160597	220, 50	180	155	110	2.84	75	0.41	EEl=A3	32	1.32
			NaHj 250.915*	161686	230, 50	180	155	110	2.84	80	0.40	EEl=A3	32	1.26
			NaHj 250.340*	504109	230/240, 50	180	155	110	2.84	80	0.39	EEl=A3	32	1.26/1.21
			NaHj 250.340	178177	240, 50	180	155	110	2.84	80	0.39	EEl=A3	32	1.21
			NaHj 250.163	529072	220, 60	160	135	95	2.50	70	0.42	A2	25	1.35
			NaHj 250.163	160604	220, 60	180	155	95	2.50	70	0.42	A2	25	1.35

* Ballasts without CE marking for replacements or markets outside of the EU

1

2

3

4

5

6

7

8

9

10

Ballasts with Thermal Cut-out for HS and HI Lamps 35 to 150 W

Shape: 53x66 mm

For high pressure sodium lamps (HS), metal halide lamps (HI) and ceramic discharge lamps (C-HI)
 Vacuum-impregnated with polyester resin
 With VS-patented, intelligent temperature switch with automatic reset (evaluates the temperature and current of the ballast)
 Protection class I
 tw 130
 Ballasts for pulse ignition system on request

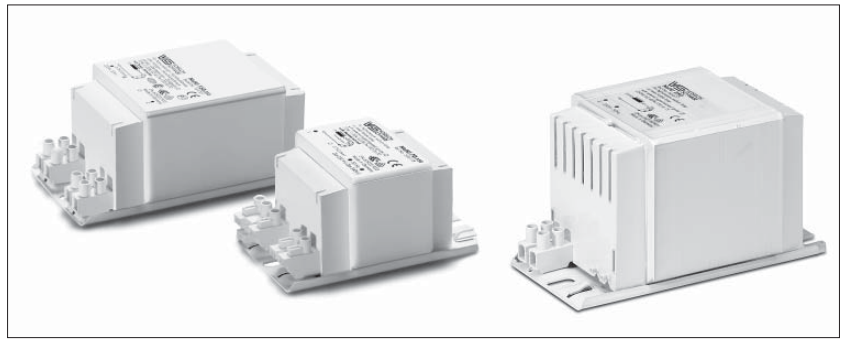

A Push-in terminals: 0.5–1.5 mm²

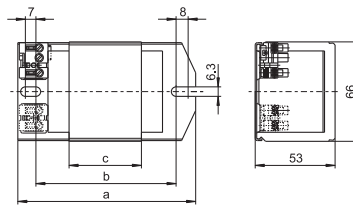

B Screw terminals: 0.5–2.5 mm²

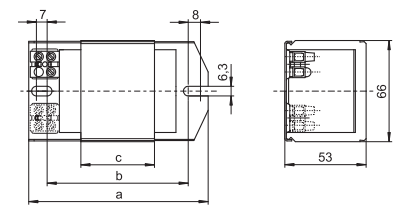

C Screw terminals: 0.75–2.5 mm²

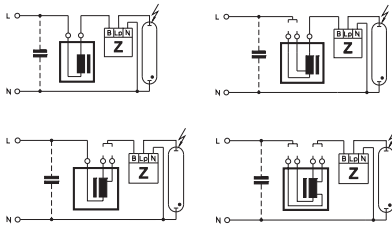
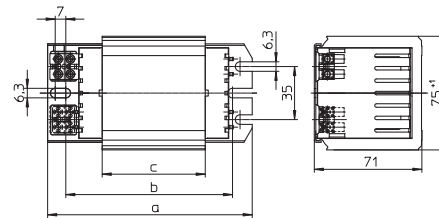

Lamp			Ballast											Capacitor	
Output W	Type	Current A	Type	Ref. No.	Voltage AC V, Hz	Drawing	a mm	b mm	c mm	Weight kg	Δt K	Power factor (λ)	Energy efficiency	C _P μF	I _N A
Push-in terminals: 0.5–1.5 mm²															
35	HS, HI	0.53	NaHJ 35.209	543737	230/240, 50	A	108	86	36	1.07	35	0.36	A2	6	0.22
			NaHJ 35.485*	506122	230/240, 50	A	108	86	36	1.07	60	0.40	EEI=A3	6	0.22/0.21
			NaHJ 35.638	509170	220, 60	A	108	86	36	1.07	50	0.41	EEI=A3	5	0.23
50	HS, HI	0.76	NaH 50.206	543738	230, 50	A	108	86	48	1.39	45	0.35	A2	8	0.30
50	HS, HI	0.76	NaHJ 70/50.157*	507341	230, 50	A	108	86	42	1.23	55	0.37	EEI=A3	8	0.30
											70	0.37	EEI=A3	12	0.38
50	HS, HI	0.76	NaHJ 70/50.520*	538361	230, 50	A	117	92	48	1.39	45	0.36	EEI=A3	8	0.30
											55	0.36	EEI=A3	12	0.38
70	HS, HI	0.98	NaHJ 70.128*	535191	230, 50	A	108	86	36	1.07	70	0.36	EEI=A3	12	0.38
			NaHJ 70.226	543741	230, 50	A	108	86	48	1.39	50	0.37	A2	12	0.38
			NaHJ 70.128*	533572	230/240, 50	A	108	86	36	1.07	70/75	0.36	EEI=A3	12	0.38/0.37
			NaHJ 70.653	509169	220, 60	A	108	86	36	1.07	60	0.42	EEI=A3	10	0.40
70	HS, HI	0.98	NaHJ 100/70.703*	507342	230, 50	A	145	120	48	1.39	60	0.37	EEI=A3	12	0.38
100	HS, HI	1.20									70	0.43	EEI=A3	12	0.55
100	HS, HI	1.20	NaHJ 100.670*	506120	230/240, 50	A	117	92	48	1.39	70	0.42	EEI=A3	12	0.55/0.53
			NaHJ 100.941*	539492	230/240, 50	A	108	86	42	1.23	75/80	0.42	EEI=A3	12	0.55/0.53
100	HS, HI	1.20	NaHJ 150/100.973*	507343	230, 50	A	145	120	75	2.02	55	0.41	A2	12	0.55
150	HS, HI	1.80									75	0.41	EEI=A3	20	0.57
150	HS, HI	1.80	NaHJ 150.620*	535216	230, 50	A	145	120	64	1.80	70	0.40	EEI=A3	20	0.77
			NaHJ 150.620*	538543	230/240, 50	A	145	120	64	1.80	70/75	0.40	EEI=A3	20	0.77/0.74
			NaHJ 150.355*	509100	230/240, 50	A	145	120	75	2.02	65	0.39	EEI=A3	20	0.77/0.74
			NaHJ 150.679	509171	220, 60	A	145	120	75	2.02	65	0.42	EEI=A3	16	0.80

* Ballasts without CE marking for replacements or markets outside of the EU

Ballasts with Thermal Cut-out for HS and HI Lamps 35 to 250 W

Shape: 53x66 mm

Lamp			Ballast											Capacitor	
Output W	Type	Current A	Type	Ref. No.	Voltage AC V, Hz	Drawing	a mm	b mm	c mm	Weight kg	Δt K	Power factor λ	Energy efficiency	Cp μF	In A
Screw terminals: 0.5–2.5 mm² (Drawing B) or 0.75–2.5 mm² (Drawing C)															
35	HS, HI	0.53	NaHj 35.485*	503010	230/240, 50	B	108	86	36	1.07	60	0.40	EEL=A3	6	0.22/0.21
35	HS, HI	0.53	NaH 50/35.412	563871	230, 50	B	117	92	55	1.52	25	0.36	A2	6	0.22
50	HS, HI	0.76									40	0.34	A2	8	0.30
35	HS, HI	0.53	NaH 50/35.797*	539515	230, 50	B	108	86	36	1.07	45	0.40	EEL=A3	6	0.22
50	HS, HI	0.76									70	0.37	EEL=A3	8	0.30
50	HS, HI	0.76	NaH 50.486*	507498	230/240, 50	B	108	86	36	1.07	65	0.37	EEL=A3	8	0.30
50	HS, HI	0.76	NaHj 70/50.695*	507697	230/240, 50	B	108	86	48	1.39	50	0.37	EEL=A3	8	0.30/0.29
70	HS, HI	0.98									70	0.37	EEL=A3	12	0.38/0.37
70	HS, HI	0.98	NaHj 70.226	563039	230, 50	B	108	86	48	1.39	50	0.37	A2	12	0.38
			NaHj 70.128*	536582	230, 50	B	108	86	36	1.07	70	0.36	EEL=A3	12	0.38
			NaHj 70.158*	169722	230/240, 50	B	108	86	42	1.23	70	0.36	EEL=A3	12	0.38/0.37
			NaHj 70.128*	538830	230/240, 50	B	108	86	36	1.07	70/75	0.36	EEL=A3	12	0.38/0.37
			NaHj 70.158	546817	240, 50	B	108	86	42	1.23	70	0.36	EEL=A3	12	0.37
70	HS, HI	0.98	NaHj 100/70.519	507628	230, 50	B	145	120	75	2.03	60	0.36	A2	12	0.38
100	HS, HI	1.20									70	0.41	A2	12	0.55
70	HS, HI	0.98	NaHj 100/70.703*	504131	230, 50	B	117	92	48	1.39	60	0.37	EEL=A3	12	0.38
100	HS, HI	1.20									70	0.43	EEL=A3	12	0.55
100	HS, HI	1.20	NaHj 100.213	554005	230/240, 50	B	117	92	55	1.55	60	0.41	A2	12	0.55/0.53
			NaHj 100.941*	543349	230, 50	B	108	86	42	1.23	75	0.42	EEL=A3	12	0.55
			NaHj 100.941*	502799	230/240, 50	B	108	86	42	1.23	75/80	0.42	EEL=A3	12	0.55/0.53
100	HS, HI	1.20	NaHj 150/100.923	563876	230, 50	C	135	115	68	2.87	30	0.40	A2	12	0.55
150	HS, HI	1.80									45	0.40	A2	20	0.77
100	HS, HI	1.20	NaHj 150/100.973*	504135	230, 50	B	145	120	75	2.02	55	0.41	A2	12	0.55
150	HS, HI	1.80									75	0.41	EEL=A3	20	0.77
150	HS, HI	1.80	NaHj 150.166	562450	230/240, 50	B	160	135	95	2.5	50	0.40	A2	20	0.77/0.74
			NaHj 150.355	539270	220, 50	B	145	120	75	2.02	65	0.39	EEL=A3	20	0.80
			NaHj 150.620*	536593	230, 50	B	145	120	64	1.80	70	0.40	EEL=A3	20	0.77
			NaHj 150.995*	169721	230/240, 50	B	145	120	75	2.02	70	0.40	EEL=A3	20	0.77/0.74
			NaHj 150.620*	538831	230/240, 50	B	145	120	64	1.80	70/75	0.40	EEL=A3	20	0.77/0.74
			NaHj 150.620	537763	240, 50	B	130	105	64	1.80	75	0.40	EEL=A3	20	0.74
			NaHj 150.679	526616	220, 60	B	145	120	75	2.02	65	0.42	EEL=A3	16	0.80
250	HS, HI	3.00	NaHj 250.915*	505054	230, 50	B	180	155	110	2.84	80	0.40	EEL=A3	32	1.26
			NaHj 250.340*	542349	230/240, 50	B	180	155	110	2.84	80	0.39	EEL=A3	32	1.26
			NaHj 250.340	508723	240, 50	B	180	155	110	2.84	80	0.39	EEL=A3	32	1.26

* Ballasts without CE marking for replacements or markets outside of the EU

1

2

3

4

5

6

7

8

9

10

Compact Ballasts for HS and HI Lamps 35 to 150 W

Shape: 53x66 mm

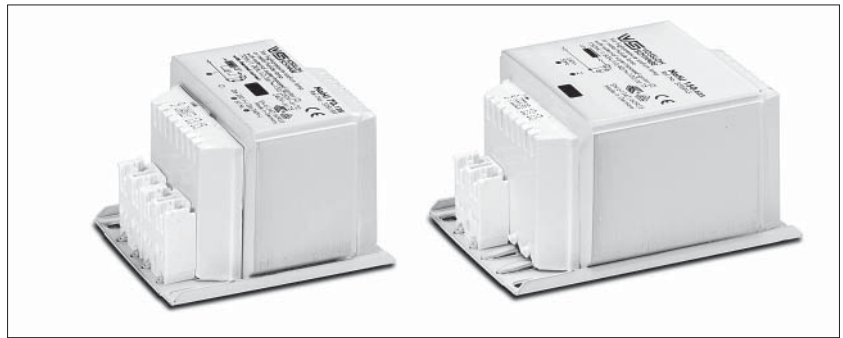

For high pressure sodium lamps (HS),
metal halide lamps (HI) and
ceramic discharge lamps (C-HI)
Vacuum-impregnated with polyester resin
Push-in terminals: 0.5–1 mm²
IDC terminals for leads H05V-U 0.5
Protection class I
Ballasts with screw terminals on request

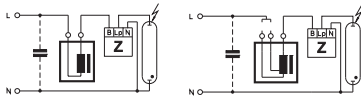
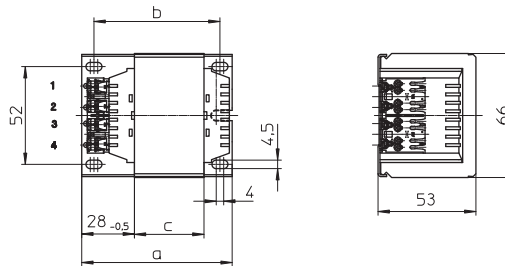

Lamp			Ballast											Capacitor	
Output W	Type	Current A	Type	Ref. No.	Voltage AC V, Hz	a mm	b mm	c mm	Weight kg	Δt K	t _w °C	Power factor λ	Energy efficiency EEL	C _p μF	I _N A
35	HS, HI	0.53	NaHJ 35.485*	538807	230/240, 50	80	67	36	1.07	60	130	0.40	EEL=A3	6	0.22/0.21
70	HS, HI	0.98	NaHJ 70.128*	538810	230, 50	80	67	36	1.07	70	130	0.36	EEL=A3	12	0.38
			NaHJ 70.128*	538823	230/240, 50	80	67	36	1.07	70/75	130	0.36	EEL=A3	12	0.38/0.37
			NaHJ 70.653	538828	220, 60	80	67	36	1.07	60	130	0.42	EEL=A3	10	0.40
150	HS, HI	1.80	NaHJ 150.620*	538834	230, 50	107	94	64	1.80	70	130	0.40	EEL=A3	20	0.77
			NaHJ 150.625	538843	240, 50	107	94	64	1.80	75	130	0.40	EEL=A3	20	0.74
			NaHJ 150.679	542557	220, 60	107	94	64	1.80	75	130	0.44	EEL=A3	16	0.80

* Ballasts without CE marking for replacements or markets outside of the EU

With Thermal Cut-out

Thermal cut-out with automatic reset

Lamp			Ballast											Capacitor	
Output W	Type	Current A	Type	Ref. No.	Voltage AC V, Hz	a mm	b mm	c mm	Weight kg	Δt K	t _w °C	Power factor λ	Energy efficiency EEL	C _p μF	I _N A
35	HS, HI	0.53	NaHJ 35.485*	538258	230/240, 50	80	67	36	1.07	60	130	0.40	EEL=A3	6	0.22/0.21
70	HS, HI	0.98	NaHJ 70.128*	539223	230/240, 50	80	67	36	1.07	70/75	140	0.36	EEL=A3	12	0.38/0.37
			NaHJ 70.653	538537	220, 60	80	67	36	1.07	60	130	0.42	EEL=A3	10	0.40
100	HS, HI	1.20	NaHJ 100.581*	539081	230/240, 50	107	94	64	1.80	60	130	0.42	EEL=A3	12	0.55/0.53
150	HS, HI	1.80	NaHJ 150.159	548260	220, 50	107	94	64	1.80	75	130	0.41	EEL=A3	20	0.77
			NaHJ 150.620*	538262	230, 50	107	94	64	1.80	70	130	0.40	EEL=A3	20	0.77
			NaHJ 150.620*	539306	230, 50	107	94	64	1.80	70	140	0.40	EEL=A3	20	0.77
			NaHJ 150.620	538264	240, 50	107	94	64	1.80	75	130	0.40	EEL=A3	20	0.74
			NaHJ 150.620	539286	240, 50	107	94	64	1.80	75	140	0.40	EEL=A3	20	0.74
			NaHJ 150.679	539311	220, 60	107	94	64	1.80	75	130	0.44	EEL=A3	16	0.80

* Ballasts without CE marking for replacements or markets outside of the EU

Ballasts with Thermal Cut-out for HS and HI Lamps 35 to 150 W, Protection Class II

Encapsulated ballast in compact plastic casing
Shape: 61x72 mm

For high pressure sodium lamps (HS), metal halide lamps (HI) and ceramic discharge lamps (C-HI)

With cable holder

Thermal cut-out with automatic reset

Screw terminals: 0.5–2.5 mm²

Protection class II

tw 130

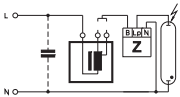
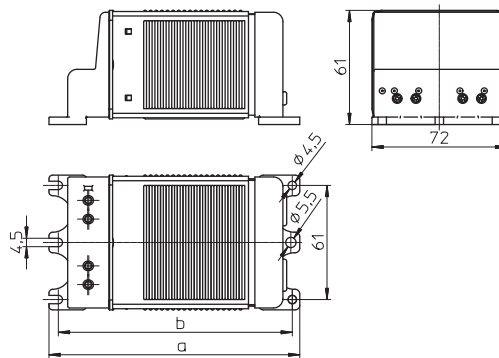

Lamp			Ballast										Capacitor	
Output W	Type	Current A	Type	Ref. No.	Voltage AC V, Hz	a mm	b mm	Weight kg	Δt K	Power factor λ	Energy efficiency	Cp μF	IN A	
35	HS, HI	0.53	NaHZ 50/35.797*	539609	230, 50	134	125	1.60	45	0.40	EEI=A3	6	0.22	
50	HS, HI	0.76							70	0.37	EEI=A3	8	0.30	
50	HS, HI	0.76	NaHJZ 70/50.520*	533395	230, 50	134	125	1.60	45	0.36	EEI=A3	8	0.30	
70	HS, HI	0.98							65	0.36	EEI=A3	12	0.38	
70	HS, HI	0.98	NaHJZ 100/70.519*	533396	230, 50	161	152	2.10	45	0.36	EEI=A3	12	0.38	
100	HS, HI	1.20							60	0.42	EEI=A3	12	0.55	
100	HS, HI	1.20	NaHJZ 150/100.466*	533398	230, 50	161	152	2.30	45	0.41	A2	12	0.85	
150	HS, HI	1.80							70	0.39	EEI=A3	20	0.77	

* Ballasts without CE marking for replacements or markets outside of the EU

Ballasts with Thermal Cut-out and Thermal Fuse for HS and HI Lamps 35 to 150 W, Protection Class II

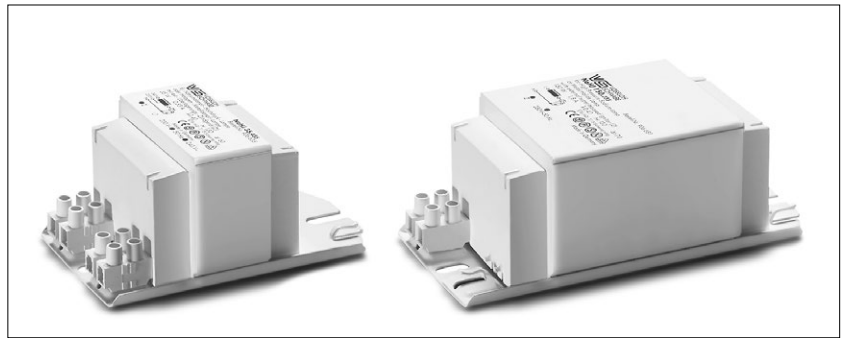

With double insulation
Shape: 53x66 mm

For high pressure sodium lamps (HS), metal halide lamps (HI) and ceramic discharge lamps (C-HI)
Thermal cut-out with automatic reset
Screw terminals: 0.5–2.5 mm²

Protection class II

tw 130

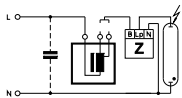
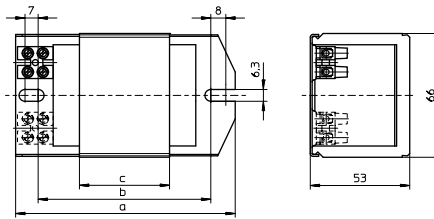

Lamp			Ballast										Capacitor	
Output W	Type	Current A	Type	Ref. No.	Voltage AC V, Hz	a mm	b mm	c mm	Weight kg	Δt K	Power factor λ	Energy efficiency	C _p μF	I _N A
35	HS, HI	0.53	NaHZ 50/35.797*	553806	230, 50	108	92	36	1.07	45	0.40	EEI=A3	6	0.22
50	HS, HI	0.76									70	0.37	EEI=A3	8
50	HS, HI	0.76	NaHJZ 70/50.785*	509490	230, 50	108	92	42	1.24	50	0.35	EEI=A3	8	0.30
70	HS, HI	0.98								70	0.38	EEI=A3	12	0.38
70	HS, HI	0.98	NaHJZ 100/70.786*	509491	230, 50	145	120	69	1.83	55	0.38	A2	12	0.38
100	HS, HI	1.20								65	0.41	A2	12	0.55
100	HS, HI	1.20	NaHJZ 150/100.787*	509492	230, 50	145	120	69	1.83	50	0.39	EEI=A3	12	0.85
150	HS, HI	1.80								75	0.41	EEI=A3	20	0.77

* Ballasts without CE marking for replacements or markets outside of the EU

Ballasts for HS and HI Lamps 150 to 400 W

Shape: 71x75 mm

For high pressure sodium lamps (HS), metal halide lamps (HI) and ceramic discharge lamps (C-HI)
 Vacuum-impregnated with polyester resin
 Screw terminals: 0.75–2.5 mm²
 Protection class I
 tw 130

Ballasts for pulse ignition system on request

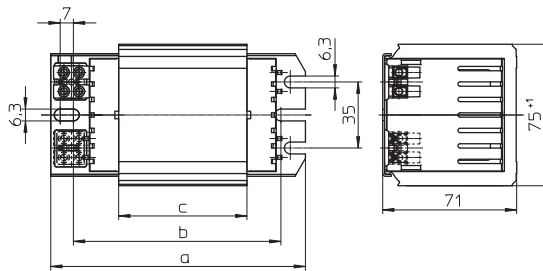
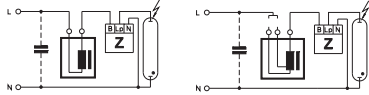

Lamp			Ballast										Capacitor	
Output W	Type	Current A	Type	Ref. No.	Voltage AC V, Hz	a mm	b mm	c mm	Weight kg	Δt K	Power factor λ	Energy efficiency	C _p μF	I _N A
250	HS, HI	3.00	NaHJ 250.741	536147	220, 50	135	115	68	2.85	70	0.42	A2	32	1.35
			NaHJ 250.741	536148	230, 50	135	115	68	2.85	75	0.40	A2	32	1.30
			NaHJ 250.741	536149	240, 50	135	115	68	2.85	75	0.39	A2	32	1.25
			NaHJ 250.742	536150	220, 60	135	115	68	2.85	70	0.42	A2	25	1.40
400	HS, HI	4.45	NaHJ 400.743	536142	220, 50	165	145	103	4.1	70	0.45	A2	45	2.10
			NaHJ 400.743	535142	230, 50	165	145	103	4.1	75	0.44	A2	45	2.00
			NaHJ 400.743	536143	240, 50	165	145	103	4.1	75	0.40	A2	45	1.85
			NaHJ 400.744	536144	220, 60	165	145	103	4.1	70	0.44	A2	40	2.05

With Thermal Cut-out

Thermal cut-out with automatic reset

Lamp			Ballast										Capacitor	
Output W	Type	Current A	Type	Ref. No.	Voltage AC V, Hz	a mm	b mm	c mm	Weight kg	Δt K	Power factor λ	Energy efficiency	C _p μF	I _N A
150	HS, HI	1.80	NaHJ 150.216	554006	230/240, 50	135	115	68	2.85	45	0.40	A2	20	0.77
250	HS, HI	3.00	NaHJ 250.741	539274	220, 50	135	115	68	2.85	70	0.42	A2	32	1.35
			NaHJ 250.741	544210	230, 50	135	115	68	2.85	65	0.40	A2	32	1.30
			NaHJ 250.741	536151	230, 50	135	115	68	2.85	75	0.40	A2	32	1.30
			NaHJ 250.741	537726	230/240, 50	135	115	68	2.85	75	0.40	A2	32	1.30/1.25
			NaHJ 250.741	536152	240, 50	135	115	68	2.85	75	0.39	A2	32	1.25
400	HS, HI	4.45	NaHJ 400.743	548259	220, 50	165	145	103	4.1	70	0.44	A2	45	2.10
			NaHJ 400.743	536145	230, 50	165	145	103	4.1	75	0.44	A2	45	2.00
			NaHJ 400.743	538204	230, 50	165	145	103	4.1	65	0.41	A2	45	2.00
			NaHJ 400.743	539209	230/240, 50	165	145	103	4.1	75	0.41	A2	45	2.00/1.85
			NaHJ 400.743	543986	240, 50	165	145	103	4.1	70	0.40	A2	45	1.85
			NaHJ 400.743	536146	240, 50	165	145	103	4.1	75	0.40	A2	45	1.85
			NaHJ 400.744	538620	220, 60	165	145	103	4.1	70	0.44	A2	40	2.05

Ballasts for HS and HI Lamps 250 to 600 W

Shape: 92x102 mm

For high pressure sodium lamps (HS), metal halide lamps (HI) and ceramic discharge lamps (C-HI)
Vacuum-impregnated with polyester resin
Screw terminals: 0.75–2.5 mm²
Protection class I
tw 130

Ballasts for pulse ignition system on request

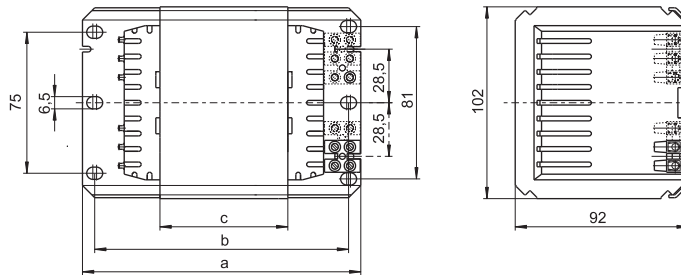
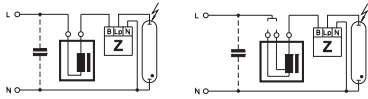

Lamp			Ballast										Capacitor	
Output W	Type	Current A	Type	Ref. No.	Voltage AC V, Hz	a mm	b mm	c mm	Weight kg	Δt K	Power factor λ	Energy efficiency	C _P μF	I _N A
250	HS, HI	3.00	NaHj 250.003	179743	220, 50	133	120	44	3.53	70	0.41	EEl=A3	32	1.32
			NaHj 250.727*	178771	230, 50	133	120	44	3.53	70	0.39	EEl=A3	32	1.26
			NaHj 250.727	500976	240, 50	133	120	44	3.53	70	0.39	EEl=A3	32	1.21
			NaHj 250.011	500401	220, 60	133	120	44	3.53	65	0.43	A2	25	1.35
400	HS, HI	4.45	NaHj 400.006	179740	220, 50	148	135	68	5.20	70	0.44	A2	45	2.00
			NaHj 400.006	178790	230, 50	148	135	68	5.20	70	0.44	A2	45	1.95
			NaHj 400.737	500402	240, 50	148	135	68	5.20	75	0.43	A2	45	1.90
			NaHj 400.012	500403	220, 60	148	135	68	5.20	70	0.44	A2	40	2.00
	HI	3.50	J 400.027	505782	230/240, 50	148	135	68	5.20	60	0.45	A2	35	1.64/1.59
600	HS	6.20	NaH 600.010	179742	220, 50	173	160	96	6.80	70	0.44	A2	65	2.90
			NaH 600.005	533484	230/240, 50	173	160	96	6.80	70	0.44	A2	65	2.90/2.85
			NaH 600.140	529560	220, 60	173	160	96	6.80	65	0.46	A2	55	3.00

* Ballasts without CE marking for replacements or markets outside of the EU

With Thermal Cut-out

Thermal cut-out with automatic reset

Lamp			Ballast										Capacitor	
Output W	Type	Current A	Type	Ref. No.	Voltage AC V, Hz	a mm	b mm	c mm	Weight kg	Δt K	Power factor λ	Energy efficiency	C _P μF	I _N A
250	HS, HI	3.00	NaHj 250.727*	500969	230/240, 50	133	120	44	3.53	70	0.39	EEl=A3	32	1.26/1.21
			NaHj 250.011	508744	220, 60	133	120	44	3.46	65	0.43	A2	25	1.35
400	HS, HI	4.45	NaHj 400.737	179424	230/240, 50	148	135	68	5.20	70/75	0.43	A2	45	1.95/1.90
	HI	3.50	J 400.027	509613	230/240, 50	148	135	68	5.20	60	0.45	A2	35	1.64/1.59
	HS, HI	4.45	NaHj 400.012	508741	220, 60	148	135	68	5.20	70	0.44	A2	40	2.00
600	HS	6.20	NaH 600.005	179454	230/240, 50	173	160	96	6.80	70	0.44	A2	65	2.90/2.85

* Ballasts without CE marking for replacements or markets outside of the EU

Ballasts for HS and HI Lamps 1000 W

Shape: 92x102 mm

For high pressure sodium lamps (HS) and metal halide lamps (HI)
 Vacuum-impregnated with polyester resin
 Screw terminals: 0.75–2.5 mm²
 Protection class I
 tw 130
 Ballasts for pulse ignition system on request

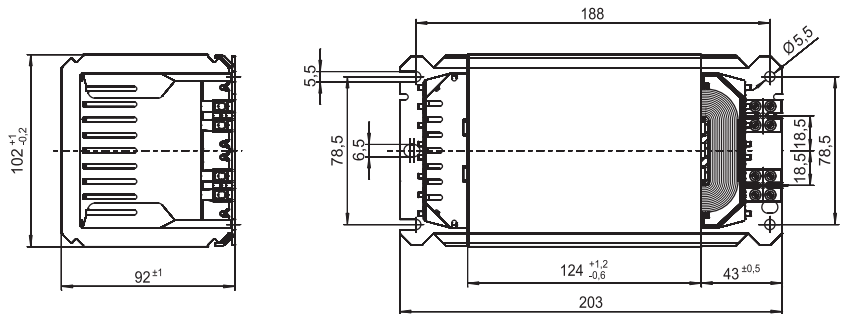
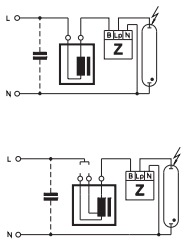

Lamp			Ballast										Capacitor	
Output W	Type	Current A	Type	Ref. No.	Voltage AC V, Hz	a mm	b mm	c mm	Weight kg	Δt K	Power factor λ	Energy efficiency	C _P μF	I _N A
1000	HS	10.30	NaHJ 1000.089	534487	220, 50	203	188	124	8.90	80	0.47	A2	100	5.1
	HI	9.50								70	0.51		85	5.0
1000	HS	10.30	NaHJ 1000.089	539212	220/230, 50	203	188	124	8.90	80	0.45	A2	100	5.1
	HI	9.50								70	0.49		85	5.0
1000	HS	10.30	NaHJ 1000.089	528548	230, 50	203	188	124	8.90	80	0.45	A2	100	5.1
	HI	9.50								70	0.49		85	5.0
1000	HS	10.30	NaHJ 1000.089	544787	230/240, 50	203	188	124	8.90	85	0.45	A2	100	5.1
	HI	9.50								70	0.46		85	5.0
1000	HS	10.30	NaHJ 1000.089	536140	240, 50	203	188	124	8.90	85	0.42	A2	100	4.8
	HI	9.50								75	0.46		85	4.9
1000	HS	10.30	NaHJ 1000.089	528536	220, 60	203	188	124	8.90	75	0.46	A2	100	5.1
	HI	9.50								60	0.50		85	5.0

Ballasts for HI Lamps up to 2500 W

Shape: 150x150 mm

For metal halide lamps (HI)
 Vacuum impregnated with polyester resin
 Screw terminals: 0.75–4 mm²
 For luminaires of protection class I
 tw 130

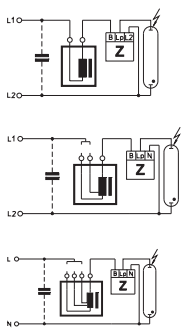

For Short Arc Lamps

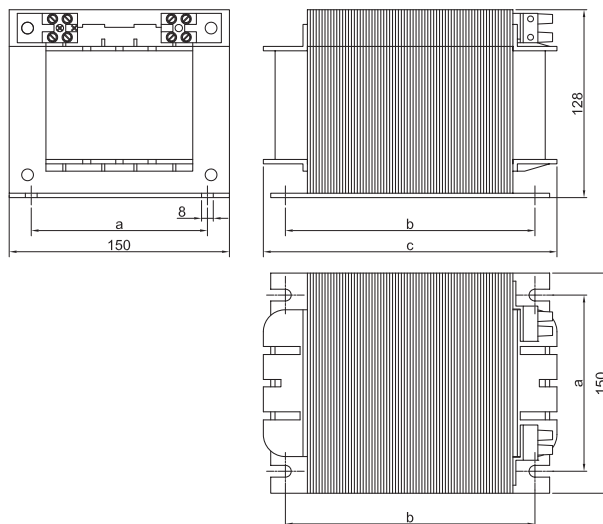
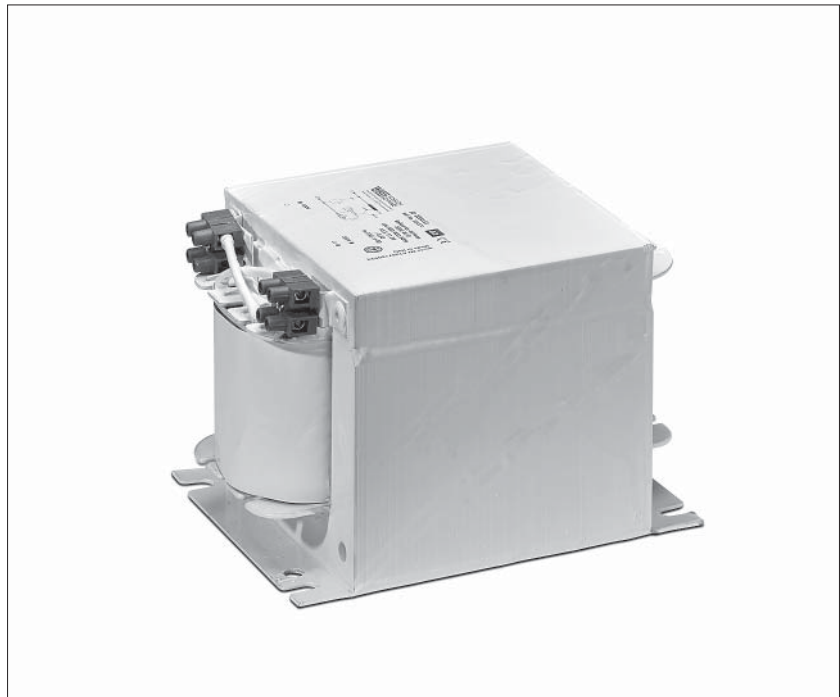

Lamp			Ballast										Capacitor	
Output W	Type	Current A	Type	Ref. No.	Voltage AC V, Hz	a mm	b mm	c mm	Weight kg	Δt K	Power factor λ	Energy efficiency	C _p μF	I _N A
2000	HI	8.8	J 2000.71	554303	380/400, 50	122	175	200	15	75	0.60	A2	37	6
			J 2000.72	554304	380/400/415, 50	122	135	160	14	70	0.58	A2	37	6
			J 2000.73	554305	380, 60	122	175	200	15	75	0.53	A2	30	6
2000	HI	10.3/11.3	JD 2000.81	554270	380/400, 50	122	175	200	15	80	0.53	A2	60	6
			JD 2000.81	554306	380/400/415, 50	122	135	160	14	75	0.52	A2	60	6
			JD 2000.83	554283	380, 60	122	175	200	15	75	0.54	A2	50	6
2000	HI	12.2	JD 2000III.91	554307	380/400, 50	122	175	200	16	80	0.46	A2	70	6
			JD 2000III.92	554308	380, 60	122	175	200	16	75	0.45	A2	60	6
2000	HI	16.5	JD 2000I.85	554309	230/240, 50	122	135	160	14	80	0.57	A2	125	10.5
			JD 2000I.86	554310	220, 60	122	135	160	14	80	0.57	A2	105	10
For Short Arc Lamps 1200 and 2500 W														
1200	HI	13.8	J 1200.95	554311	208, 60	122	105	130	11	-	0.40	A2	150	6
					230/245, 50									
2500	HI	25.6	J 2500.96	554312	208, 60	122	175	200	16	-	0.44	A2	260	12.3
					230/245, 50									

Ballasts for HM and HI Lamps 50 to 400 W

Shape: 53x66 mm

For mercury vapour lamps (HM) and metal halide lamps (HI) with ignition voltage 1 kV
Vacuum-impregnated with polyester resin
Screw terminals: 0.5–2.5 mm²
Protection class I
tw 130

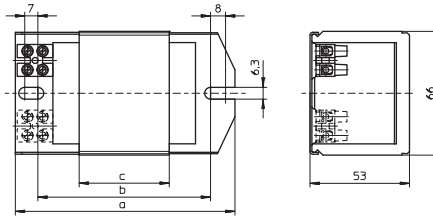
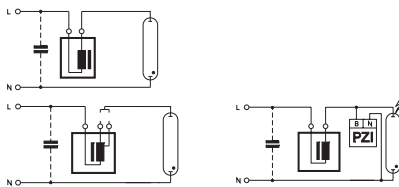
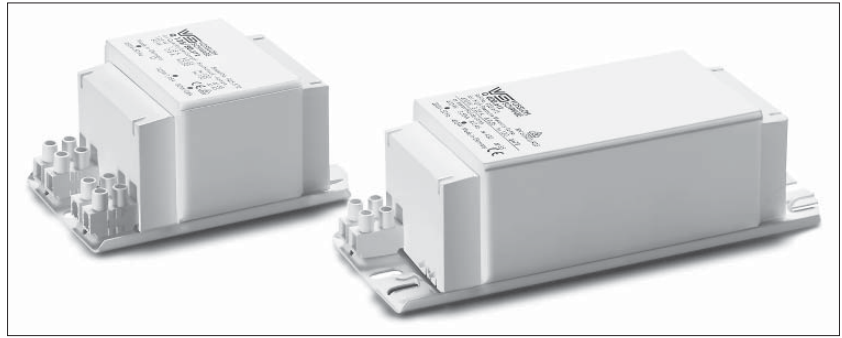

Lamp			Ballast										Capacitor	
Output W	Type	Current A	Type	Ref. No.	Voltage AC V, Hz	a mm	b mm	c mm	Weight kg	Δt K	Power factor λ	Energy efficiency	Cp μF	I _N A
50	HM	0.61	Q 50.501	167100	220, 50	108	86	36	1.07	55	0.44	EEl=A3	7	0.28
			Q 50.550*	167213	230, 50	108	86	36	1.07	55	0.44	EEl=A3	7	0.27
			Q 50.508	167125	240, 50	108	86	36	1.07	65	0.42	EEl=A3	7	0.26
			Q 50.535	167185	220, 60	108	86	36	1.07	50	0.44	EEl=A3	6	0.28
50	HM	0.61	Q 80/50.596*	167311	230, 50	108	86	36	1.07	55	0.43	EEl=A3	7	0.27
80	HM	0.80								70	0.51	EEl=A3	8	0.41
50	HM	0.61	Q 80/50.592	167306	220, 60	108	86	36	1.07	50	0.44	EEl=A3	6	0.28
80	HM	0.80								60	0.53	EEl=A3	7	0.43
80	HM	0.80	Q 80.587	167302	220, 50	108	86	36	1.07	65	0.52	EEl=A3	8	0.43
			Q 80.588*	167304	230, 50	108	86	36	1.07	70	0.51	EEl=A3	8	0.41
			Q 80.510	167132	240, 50	108	86	36	1.07	60	0.48	EEl=A3	8	0.40
			Q 80.584	167299	220, 60	108	86	36	1.07	55	0.51	EEl=A3	7	0.43
80	HM	0.80	Q 125/80.611*	167326	230, 50	108	86	42	1.23	50	0.49	EEl=A3	8	0.41
125	HM	1.15								70	0.54	EEl=A3	10	0.60
80	HM	0.80	Q 125/80.511	167136	240, 50	108	86	48	1.39	50	0.48	EEl=A3	8	0.40
125	HM	1.15								70	0.52	EEl=A3	10	0.58
125	HM	1.15	Q 125.549	169947	220, 50	108	86	36	1.07	70	0.56	EEl=A3	10	0.63
			Q 125.568*	167263	230, 50	108	86	36	1.07	75	0.54	EEl=A3	10	0.60
			Q 125.512	167140	240, 50	108	86	48	1.39	65	0.51	EEl=A3	10	0.58
			Q 125.598	502818	220, 60	108	86	36	1.07	60	0.57	EEl=A3	10	0.65
250	HM	2.13	Q 250.513	167144**	220, 50	145	120	75	2.10	75	0.58	A2	18	1.26
			Q 250.528	167367**	230, 50	145	120	75	2.10	75	0.56	A2	18	1.20
			Q 250.703	507256**	240, 50	145	120	75	2.10	75	0.53	A2	18	1.15
			Q 250.606	533705**	220, 60	145	120	64	1.80	70	0.58	A2	15	1.30
400	HM	3.25	Q 400.616	528236**	220, 50	160	135	95	2.50	80	0.60	EEl=A3	25	2.00
			Q 400.561	167250**	220, 50	180	155	110	2.88	75	0.60	A2	25	2.00
			Q 400.612	167330**	230, 50	180	155	110	2.88	75	0.56	A2	25	1.90
			Q 400.669	167374**	240, 50	180	155	110	2.88	75	0.54	A2	25	1.85
			Q 400.613	167335**	220, 60	180	155	110	2.88	65	0.60	A2	25	2.00
			Q 400.613	508245**	220, 60	180	155	95	2.50	75	0.60	A2	25	2.00

* Ballasts without CE marking for replacements or markets outside of the EU

** Suitable for metal halide lamps (HI) with ignition voltage 1 kV in combination with pulse ignitor PZI 1000/1 K (see page 52)

Ballasts for HM and HI Lamps 250 and 400 W

Shape: 71x75 mm

For mercury vapour lamps (HM) and metal halide lamps (HI) with ignition voltage 1 kV
 Vacuum-impregnated with polyester resin
 Screw terminals: 0.75–2.5 mm²
 Protection class I
 tw 130

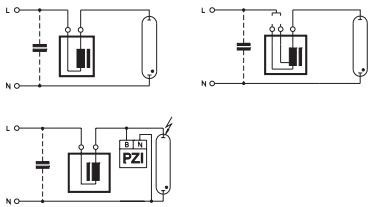
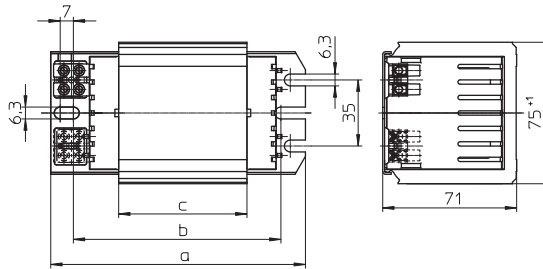

Lamp			Ballast										Capacitor	
Output W	Type	Current A	Type	Ref. No.	Voltage AC V, Hz	a mm	b mm	c mm	Weight kg	Δt K	Power factor λ	Energy efficiency	C _p μF	I _N A
250	HM	2.13	Q 250.800	536260*	230/240, 50	135	115	68	2.85	55	0.53	A2	18	1.3
400	HM	3.25	Q 400.715	537869*	220, 50	135	115	68	2.85	70	0.59	A2	25	2.0
			Q 400.801	536258*	230, 50	135	115	68	2.85	75	0.58	A2	25	2.0
			Q 400.801	538034*	230, 50	135	115	68	2.85	65	0.58	A2	25	2.0
			Q 400.801	537703*	230/240, 50	135	115	68	2.85	75	0.58	A2	25	2.0/1.85
			Q 400.732	537873*	220, 60	135	115	68	2.85	70	0.59	A2	25	2.0

* Suitable for metal halide lamps (HI) with ignition voltage 1 kV in combination with pulse ignitor PZI 1000/1 K (see page 52)

With Thermal Cut-out

Thermal cut-out with automatic reset

Lamp			Ballast										Capacitor	
Output W	Type	Current A	Type	Ref. No.	Voltage AC V, Hz	a mm	b mm	c mm	Weight kg	Δt K	Power factor λ	Energy efficiency	C _p μF	I _N A
250	HM	2.13	Q 250.800	536261*	230/240, 50	135	115	68	2.85	55	0.53	A2	18	1.3
400	HM	3.25	Q 400.801	536259*	230, 50	135	115	68	2.85	75	0.58	A2	25	2.0

* Suitable for metal halide lamps (HI) with ignition voltage 1 kV in combination with pulse ignitor PZI 1000/1 K (see page 52)

Ballasts for HM and HI Lamps 250 to 1000 W

Shape: 92x102 mm

For mercury vapour lamps (HM) and metal halide lamps (HI) with ignition voltage 1 kV
Vacuum-impregnated with polyester resin

Screw terminals: 0.75–2.5 mm²

Protection class I

tw 130

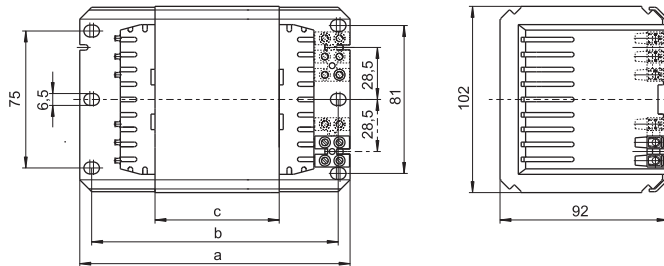
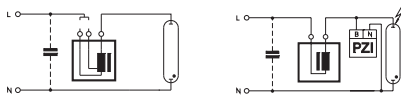
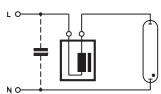

Lamp			Ballast										Capacitor	
Output W	Type	Current A	Type	Ref. No.	Voltage AC V, Hz	a mm	b mm	c mm	Weight kg	Δt K	Power factor λ	Energy efficiency	C _P μF	I _N A
250	HM	2.13	Q 250.417	504467*	230/240, 50	133	120	44	3.53	50	0.52	A2	18	1.20
400	HM	3.25	Q 400.001	504474*	230/240, 50	133	120	44	3.53	65	0.56	A2	25	1.80
700	HM	5.40	Q 700.035	528521	230/240, 50	173	160	96	6.90	60	0.56	A2	40	3.40
1000	HM	7.50	Q 1000.097	537103*	220, 50	173	160	96	6.90	75	0.61	A2	60	4.80
			Q 1000.096	538540*	230, 50	173	160	96	6.90	65	0.60	A2	60	4.80
			Q 1000.096	528761*	230, 50	173	160	96	6.90	65	0.60	A2	60	4.80
			Q 1000.145	528886*	240, 50	173	160	96	6.90	75	0.58	A2	60	4.60
			Q 1000.311	526715*	220, 60	173	160	96	6.90	70	0.61	A2	50	5.00

* Suitable for metal halide lamps (HI) with ignition voltage 1 kV in combination with pulse ignitor PZI 1000/1 K (see page 52)

With Thermal Cut-out

Thermal cut-out with automatic reset

Lamp			Ballast										Capacitor	
Output W	Type	Current A	Type	Ref. No.	Voltage AC V, Hz	a mm	b mm	c mm	Weight kg	Δt K	Power factor λ	Energy efficiency	C _P μF	I _N A
250	HM	2.13	Q 250.417	508746*	230/240, 50	133	120	44	3.53	50	0.52	A2	18	1.20
400	HM	3.25	Q 400.001	505002*	230/240, 50	133	120	44	3.53	65	0.56	A2	25	1.80

* Suitable for metal halide lamps (HI) with ignition voltage 1 kV in combination with pulse ignitor PZI 1000/1 K (see page 52)

Compact Power Reduction Kits for HS Lamps 50 to 150 W

Ballast shape: 53x66 mm

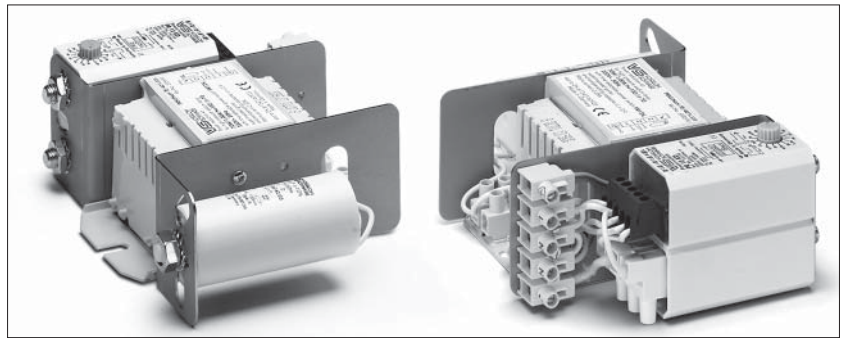

For high pressure sodium lamps (HS)
Compact power reduction kit with ballast with or without patented, intelligent thermal cut-out with automatic reset (which evaluates the temperature and current of the ballast), ignitor, power switch and compensation capacitor

With luminaire terminal block:

screw terminal 0.75–2.5 mm²

With earth terminal

Permissible load capacity: 20–100 pF

Lead length to the lamp: max. 1.5 m

tw 130

Further outputs and voltages on request

With digital timer ignitor on request

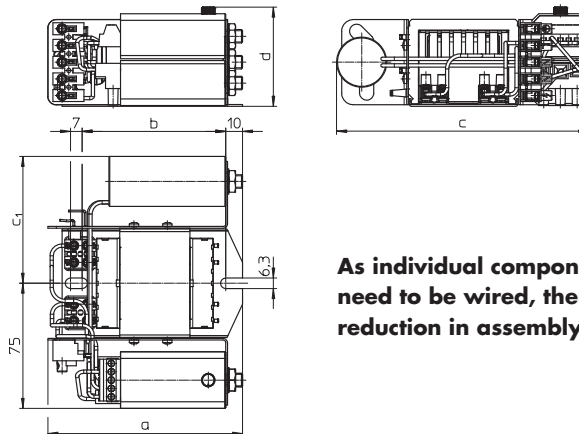

As individual components no longer need to be wired, there is a significant reduction in assembly time and costs.

Lamp			Power reduction kit														
Output	Type	Current	Type	Ref. No.	Voltage AC V, Hz	Mains current A	Temperature protection	a mm	b mm	c mm	c1 mm	d mm	Weight kg	Power factor λ	Energy efficiency		
Power reduction without control phase – Intelligent power switch PR 12 K LC (Light Control)																	
70/40%	HS	0.98	PRKUNaH 70/40%.525	543384	220, 50	0.38	no	117	86	151	76	60	1.5	> 0.90	EEI=A3		
100/40%	HS	1.20	PRKUNaH 100/40%.522	543388	220, 50	0.56	no	123	92	151	76	60	1.7	> 0.90	EEI=A3		
150/40%	HS	1.80	PRKUNaH 150/40%.142	543385	220, 50	0.77	no	151	120	154	79	60	2.3	> 0.90	EEI=A3		
50/40%	HS	0.76	PRKUNaH 50/40%.021*	544760	230, 50	0.30	yes	117	86	151	76	56	1.5	> 0.90	EEI=A3		
70/40%	HS	0.98	PRKUNaH 70/40%.525*	543742	230, 50	0.38	yes	117	86	151	76	60	1.5	> 0.90	EEI=A3		
100/40%	HS	1.20	PRKUNaH 100/40%.522*	543743	230, 50	0.55	yes	123	92	151	76	60	1.7	> 0.90	EEI=A3		
150/40%	HS	1.80	PRKUNaH 150/40%.142*	543744	230, 50	0.77	yes	151	120	154	79	60	2.3	> 0.90	EEI=A3		
Power reduction without control phase – Power switch PR 12 KD with selectable switching time																	
70/40%	HS	0.98	PRKUNaH 70/40%.525	539328	220, 50	0.38	no	117	86	151	76	60	1.5	> 0.90	EEI=A3		
100/40%	HS	1.20	PRKUNaH 100/40%.522	539330	220, 50	0.56	no	123	92	151	76	60	1.7	> 0.90	EEI=A3		
150/40%	HS	1.80	PRKUNaH 150/40%.142	539332	220, 50	0.77	no	151	120	154	79	60	2.3	> 0.90	EEI=A3		
70/40%	HS	0.98	PRKUNaH 70/40%.525*	538690	230, 50	0.38	yes	117	86	151	76	60	1.5	> 0.90	EEI=A3		
100/40%	HS	1.20	PRKUNaH 100/40%.522*	538691	230, 50	0.56	yes	123	92	151	76	60	1.7	> 0.90	EEI=A3		
150/40%	HS	1.80	PRKUNaH 150/40%.142	538692	230, 50	0.77	yes	151	120	154	79	60	2.3	> 0.90	EEI=A3		
70/40%	HS	0.98	PRKUNaH 70/40%.525	538700	220, 60	0.38	no	117	86	151	76	60	1.5	> 0.90	EEI=A3		
100/40%	HS	1.20	PRKUNaH 100/40%.522	538701	220, 60	0.56	no	123	92	151	76	60	1.7	> 0.90	EEI=A3		
150/40%	HS	1.80	PRKUNaH 150/40%.142	538702	220, 60	0.77	no	151	120	154	79	60	2.3	> 0.90	EEI=A3		
Power reduction with control phase – Power switch PU 12 K																	
70/40%	HS	0.98	PRKUNaH 70/40%.525	539329	220, 50	0.38	no	117	86	151	76	56	1.5	> 0.90	EEI=A3		
100/40%	HS	1.20	PRKUNaH 100/40%.522	539331	220, 50	0.56	no	123	92	151	76	56	1.7	> 0.90	EEI=A3		
150/40%	HS	1.80	PRKUNaH 150/40%.142	539333	220, 50	0.77	no	151	120	154	79	56	2.3	> 0.90	EEI=A3		
70/40%	HS	0.98	PRKUNaH 70/40%.525*	538695	230, 50	0.38	yes	117	86	151	76	56	1.5	> 0.90	EEI=A3		
100/40%	HS	1.20	PRKUNaH 100/40%.522*	538696	230, 50	0.56	yes	123	92	151	76	56	1.7	> 0.90	EEI=A3		
150/40%	HS	1.80	PRKUNaH 150/40%.142*	538697	230, 50	0.77	yes	151	120	154	79	56	2.3	> 0.90	EEI=A3		
70/40%	HS	0.98	PRKUNaH 70/40%.525	538705	220, 60	0.38	no	117	86	151	76	56	1.5	> 0.90	EEI=A3		
100/40%	HS	1.20	PRKUNaH 100/40%.522	538706	220, 60	0.56	no	123	92	151	76	56	1.7	> 0.90	EEI=A3		
150/40%	HS	1.80	PRKUNaH 150/40%.142	538707	220, 60	0.77	no	151	120	154	79	56	2.3	> 0.90	EEI=A3		

* Ballasts without CE marking for replacements or markets outside of the EU

Compact Power Reduction Kits for HS Lamps 250 and 400 W

Ballast shape: 71x75 mm

For high pressure sodium lamps (HS)
Compact power reduction kit with ballast with or without thermal cut-out with automatic reset, superimposed ignitor, power switch and compensation capacitor

With luminaire terminal block:

screw terminal 0.75–2.5 mm²

With earth terminal

Permissible load capacity: 20–100 pF

Lead length to the lamp: max. 1.5 m

tw 130

Further outputs and voltages on request

With digital timer ignitor on request

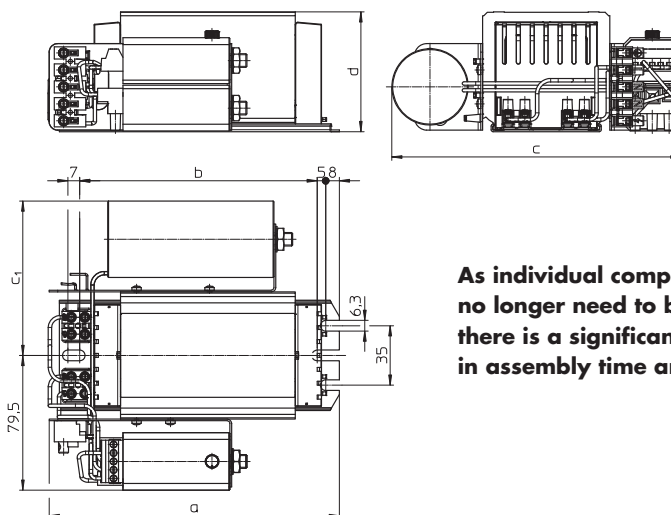
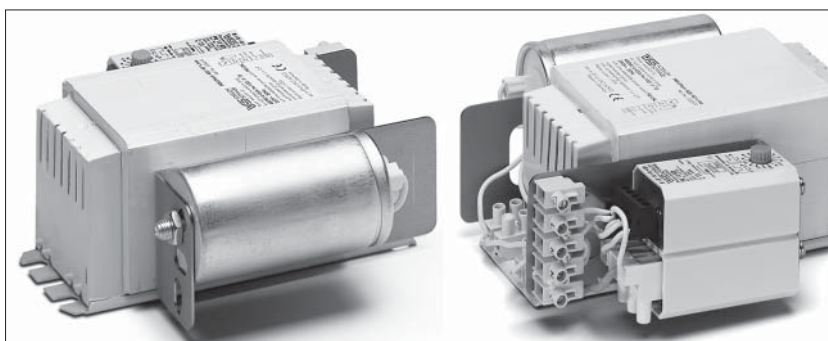

As individual components no longer need to be wired, there is a significant reduction in assembly time and costs.

Lamp			Power reduction kit													
Output	Type	Current	Type	Ref. No.	Voltage	Mains	Temperature	a	b	c	c1	d	Weight	Power	Energy	
W		A			AC	current	protection	mm	mm	mm	mm	mm	kg	λ	efficiency	
					V, Hz	A										
Power reduction without control phase – Intelligent power switch PR 12 K LC (Light Control)																
250/40%	HS	3.00	PRKUNaH 250/40%.936*	543386	220, 50	1.26	no	141	110	171	91	71	3.3	> 0.90	EEl=A3	
400/40%	HS	4.45	PRKUNaH 400/40%.906	543389	220, 50	1.95	no	171	140	171	91	71	5.3	> 0.90	A2	
250/40%	HS	3.00	PRKUNaH 250/40%.936*	543745	230, 50	1.26	yes	141	110	171	91	71	3.3	> 0.90	EEl=A3	
400/40%	HS	4.45	PRKUNaH 400/40%.906	543746	230, 50	1.95	yes	171	140	171	91	71	5.3	> 0.90	A2	
Power reduction without control phase – Power switch PR 12 KD with selectable switching time																
250/40%	HS	3.00	PRKUNaH 250/40%.758	546585	220, 50	1.26	no	171	140	171	91	71	5.3	> 0.90	EEl=A3	
250/40%	HS	3.00	PRKUNaH 250/40%.936	539334	220, 50	1.26	no	141	110	171	91	71	3.3	> 0.90	EEl=A3	
400/40%	HS	4.45	PRKUNaH 400/40%.906	539335	220, 50	1.95	no	171	140	171	91	71	5.3	> 0.90	A2	
250/40%	HS	3.00	PRKUNaH 250/40%.936*	538693	230, 50	1.26	yes	141	110	171	91	71	3.3	> 0.90	EEl=A3	
400/40%	HS	4.45	PRKUNaH 400/40%.906	538694	230, 50	1.95	yes	171	140	171	91	71	5.3	> 0.90	A2	
250/40%	HS	3.00	PRKUNaH 250/40%.983	538703	220, 60	1.26	no	141	110	165	86	71	3.3	> 0.90	EEl=A3	
400/40%	HS	4.45	PRKUNaH 400/40%.937	538704	220, 60	1.95	no	171	140	171	91	71	5.3	> 0.90	A2	
Power reduction with control phase – Power switch PU 12 K																
250/40%	HS	3.00	PRKUNaH 250/40%.936	539336	220, 50	1.26	no	141	110	171	91	71	3.3	> 0.90	EEl=A3	
400/40%	HS	4.45	PRKUNaH 400/40%.906	539337	220, 50	1.95	no	171	140	171	91	71	5.3	> 0.90	A2	
250/40%	HS	3.00	PRKUNaH 250/40%.936*	538698	230, 50	1.26	yes	141	110	171	91	71	3.3	> 0.90	EEl=A3	
400/40%	HS	4.45	PRKUNaH 400/40%.906	538699	230, 50	1.95	yes	171	140	171	91	71	5.3	> 0.90	A2	
250/40%	HS	3.00	PRKUNaH 250/40%.983	538708	220, 60	1.26	no	141	110	165	86	71	3.3	> 0.90	EEl=A3	
400/40%	HS	4.45	PRKUNaH 400/40%.937	538709	220, 60	1.95	no	171	140	171	91	71	5.3	> 0.90	A2	

* Ballasts without CE marking for replacements or markets outside of the EU

Ballasts for Power Reduction of HS Lamps 70 to 250 W

Shape: 53x66 mm

For high pressure sodium lamps (HS)
 Vacuum-impregnated with polyester resin
 Screw terminals: 0.5–2.5 mm²
 Protection class I
 tw 130

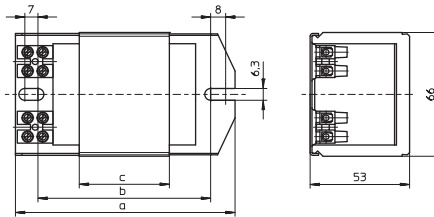
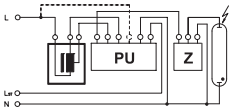
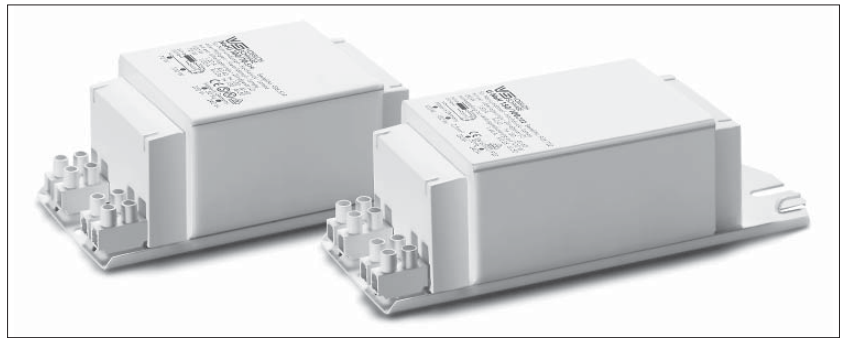

Lamp			Ballast										Capacitor	
Output W	Type	Current A	Type	Ref. No.	Voltage AC V, Hz	a mm	b mm	c mm	Weight kg	Δt K	Power factor λ	Energy efficiency	Cp μF	In A
70 (42)	HS	0.98	UNaH 70/40%.501	534128	220, 50	108	86	42	1.23	65	0.39	EEI=A3	12	0.40
			UNaH 70/40%.525*	535348	230, 50	108	86	42	1.23	70	0.38	EEI=A3	12	0.38
			UNaH 70/40%.691	161460	220, 60	108	86	48	1.39	60	0.42	EEI=A3	10	0.40
100 (60)	HS	1.20	UNaH 100/40%.452	533947	220, 50	117	92	55	1.52	65	0.43	EEI=A3	12	0.55
			UNaH 100/40%.522*	535347	230, 50	117	92	55	1.52	70	0.42	EEI=A3	12	0.55
			NaHJ 100/70.709	161471	220, 60	145	120	48	1.39	60/50	0.44	EEI=A3	10	0.57
150 (90)	HS	1.80	UNaH 150/40%.453	533948	220, 50	145	120	75	2.03	75	0.42	EEI=A3	20	0.80
			UNaH 150/40%.142*	535333	230, 50	145	120	75	2.03	75	0.40	EEI=A3	20	0.77
			UNaH 150/40%.717	161475	220, 60	145	120	75	2.03	70	0.44	EEI=A3	20	0.77
250 (150)	HS	3.00	UNaH 250/40%.454	533949	220, 50	180	155	110	2.88	80	0.42	EEI=A3	32	1.32
			UNaH 250/40%.983	169892	220, 60	145	120	75	2.03	75	0.40	EEI=A3	32	1.32

* Ballasts without CE marking for replacements or markets outside of the EU

Ballasts with Thermal Cut-out for Power Reduction of HS Lamps 50 to 150 W

Shape: 53x66 mm

For high pressure sodium lamps (HS)
 Vacuum-impregnated with polyester resin
 Thermal cut-out with automatic reset
 Protection class I
 tw 130

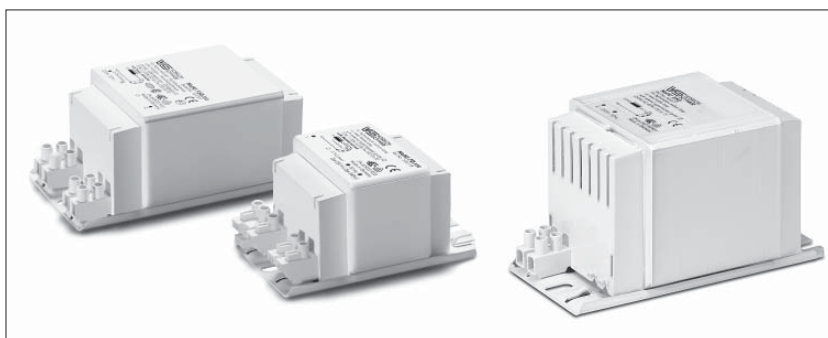

A Push-in terminals: 0.5–1.5 mm²

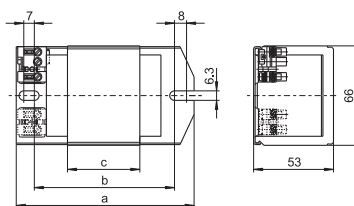

B Screw terminals: 0.5–2.5 mm²

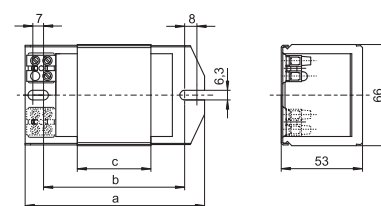

C Screw terminals: 0.75–2.5 mm²

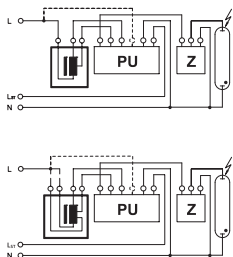
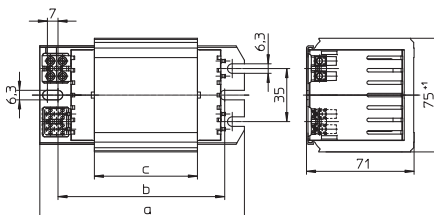

Lamp		Ballast											Capacitor		
Output W	Type	Current A	Type	Ref. No.	Voltage AC V, Hz	Drawing mm	a mm	b mm	c mm	Weight kg	Δt K	Power factor λ	Energy efficiency	Cp μF	I _N A
With push-in terminals: 0.5–1.5 mm²															
70 (42)	HS	0.98	UNaH 70/40%.525*	544728	230, 50	A	108	86	42	1.23	70	0.38	EEL=A3	12	0.38
100 (60)	HS	1.20	UNaH 100/40%.522*	544730	230, 50	A	117	92	55	1.55	70	0.42	EEL=A3	12	0.55
150 (90)	HS	1.80	UNaH 150/40%.142*	544729	230, 50	A	145	120	75	2.10	75	0.40	EEL=A3	20	0.77
150 (101)	HS	1.80	UNaH 150/100.722*	539050	230/240, 50	A	160	135	95	2.50	65/50	0.41	EEL=A3	20	0.77
150 (101)	HS	1.80	UNaH 150/100.722*	507627	230/240, 50	A	180	155	95	2.50	65/50	0.41	EEL=A3	20	0.77
With screw terminals: 0.5–2.5 mm² (Drawing B) or 0.75–2.5 mm² (Drawing C)															
50 (33)	HS	0.76	NaH 50/35.412	563871	230, 50	B	117	92	55	1.07	40/25	0.34	A2	6	0.22
			NaH 50/35.797*	539515	230, 50	B	108	86	36	1.07	70/45	0.37	EEL=A3	6	0.22
70 (44)	HS	0.98	NaHJ 70/50.411	563870	230, 50	B	108	86	48	1.34	50/35	0.37	A2	12	0.38
			NaHJ 70/50.695*	503136	230, 50	B	108	86	48	1.34	70/50	0.37	EEL=A3	12	0.38
			UNAH 70/40%.413	563872	230, 50	B	117	92	55	1.52	50/35	0.37	A2	12	0.38
100 (64)	HS	1.20	NaHJ 100/70.519	507628	230, 50	B	145	120	75	2.03	60/50	0.42	A2	12	0.55
			NaHJ 100/70.703*	504131	230, 50	B	117	92	48	1.39	70/60	0.43	EEL=A3	12	0.55
			UNAH 100/40%.41	563873	230, 50	B	145	120	75	2.03	50	0.41	A2	12	0.55
150 (101)	HS	1.80	NaHJ 150/100.923	563876	230, 50	C	135	115	68	2.87	45/35	0.40	A2	20	0.77
			NaHJ 150/100.973*	504135	230, 50	B	145	120	75	2.10	75/55	0.41	EEL=A3/ A2	20	0.77
			UNAH 150/40%.922	563874	230, 50	C	135	115	68	2.87	45/35	0.40	A2	20	0.77

* Ballasts without CE marking for replacements or markets outside of the EU

Ballasts with Thermal Cut-out for Power Reduction of HS Lamps 70 to 150 W, Protection Class II



Encapsulated ballast in compact plastic casing
Shape: 61x72 mm

For high pressure sodium lamps (HS)
 With cable holder
 Thermal cut-out with automatic reset
 Screw terminals: 0.5–2.5 mm²

Protection class II

tw 130

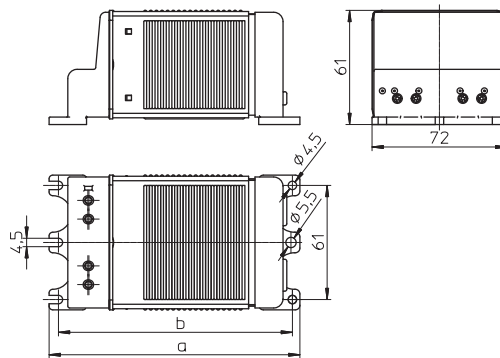
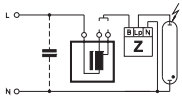

Lamp			Ballast										Capacitor	
Output W	Type	Current A	Type	Ref. No.	Voltage AC V, Hz	a mm	b mm	Weight kg	Δt K	Power factor λ	Energy efficiency	C _P μF	I _N A	
70 (44)	HS	0.98	NaHJZ 70/50.520*	533395	230, 50	134	125	1.52	65/45	0.36	EEl=A3	12	0.38	
100 (64)	HS	1.20	NaHJZ 100/70.519*	533396	230, 50	161	152	2.10	60/45	0.42	EEl=A3	12	0.55	
150 (101)	HS	1.80	NaHJZ 150/100.466*	533398	230, 50	161	152	2.30	70/45	0.39	EEl=A3	20	0.77	

* Ballasts without CE marking for replacements or markets outside of the EU

Ballasts for Power Reduction of HS Lamps 250 to 600 W

Shape: 71x75 mm
Shape: 92x102 mm

For high pressure sodium lamps (HS)
Vacuum-impregnated with polyester resin
Screw terminals: 0.75–2.5 mm²
Protection class I
tw 130

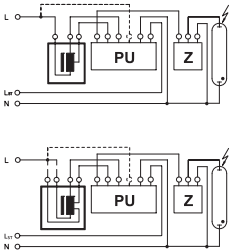
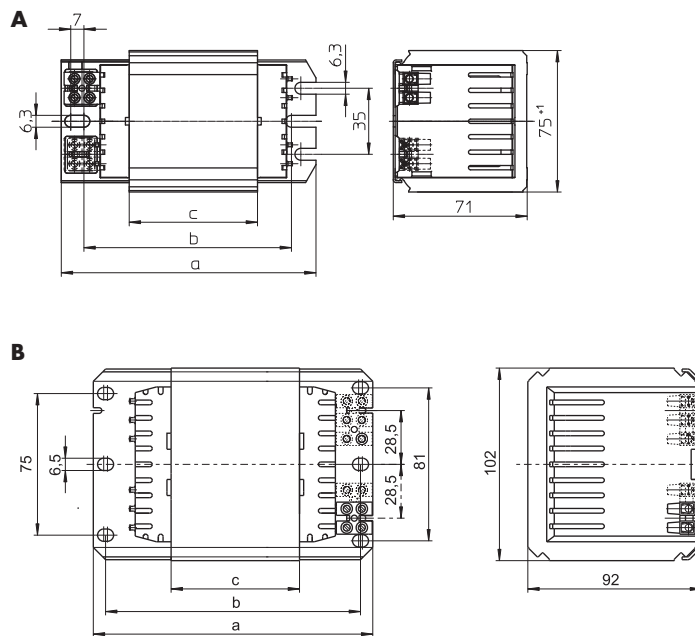

Lamp			Ballast											Capacitor	
Output	Type	Current	Type	Ref. No.	Voltage AC	Drawing	a	b	c	Weight	Δt	Power factor	Energy efficiency	Cp	IN
W		A			V, Hz		mm	mm	mm	kg	K	λ		μF	A
250 (150)	HS	3.00	UNaH 250/40%.746	539283	220, 50	A	135	115	68	2.85	75	0.42	EEl=A3	32	1.35
			UNaH 250/150.176	530509	230, 50	B	133	120	44	3.97	65	0.40	A2	32	1.30
			UNaH 250/40%.936*	543747	230, 50	A	135	115	68	2.85	75	0.40	EEl=A3	32	1.30
			UNaH 250/40%.747	539517	220, 60	A	135	115	68	2.85	75	0.42	EEl=A3	25	1.40
400 (240)	HS	4.45	UNaH 400/40%.892	538592	220, 50	A	165	145	103	4.13	75	0.44	A2	45	2.10
			UNaH 400/40%.906	543748	230, 50	A	165	145	103	4.13	75	0.42	A2	45	2.00
			UNaH 400/40%.937	538715	220, 60	A	165	145	103	4.13	75	0.44	A2	40	2.05
600 (360)	HS	6.20	UNaH 600/40%.060	539384	230/240, 50	B	173	160	108	6.80	75	0.44	A2	65	2.80

* Ballasts without CE marking for replacements or markets outside of the EU

With Thermal Cut-out

Thermal cut-out with automatic reset

Lamp			Ballast											Capacitor	
Output	Type	Current	Type	Ref. No.	Voltage AC	Drawing	a	b	c	Weight	Δt	Power factor	Energy efficiency	Cp	IN
W		A			V, Hz		mm	mm	mm	kg	K	λ		μF	A
250 (150)	HS	3.00	UNaH 250/40%.936*	538711	230, 50	A	135	115	68	2.85	75	0.40	EEl=A3	32	1.30
400 (240)	HS	4.45	UNaH 400/40%.906	538710	230, 50	A	165	145	103	4.13	75	0.42	A2	45	2.00

* Ballasts without CE marking for replacements or markets outside of the EU

SUPERIMPOSED, PULSE AND INSTANT RESTRIKE

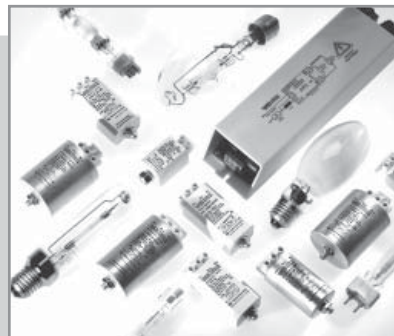

ELECTRONIC IGNITORS

Superimposed ignitors

Superimposed ignitors work independently of ballasts and generate defined ignition pulses during every half-wave within the stipulated voltage ranges. As the mains frequency only plays a subordinate role, these systems work equally well at 50 Hz and 60 Hz.

Superimposed ignitors should be mounted near the lampholder. The clearance needed between the ignitor and the lamp is determined by the respective maximum load capacitance, which is specified for each ignitor in the technical details. The capacitive load of the cable is dependent on its physical properties and wiring layout; this value usually ranges between 70–100 pF per metre.

Pulse ignitors

As pulse ignitors use the winding of an inductive ballast to generate the requisite pulse voltage, such ballasts must be designed to withstand these high ignition voltages.

Instant restrike ignitors

Instant restrike ignitors are a special type of ignitor for high-pressure discharge lamps. In comparison to superimposed and pulse ignitors, instant restrike ignitors have a very specified field of application. However, safety-relevant lighting systems, e.g. in power plants, stadiums, but also in television studios, make instant re-ignition of hot high-pressure discharge lamps necessary.

On the following pages, Vossloh-Schwabe presents an extensive range of ignitors for all areas of application.



Electronic superimposed ignitors	42-50
Pulse ignitors	51-52
Instant restrike ignitors	53-54
Electronic power switches	55
Electronic superimposed ignitors with power switch	56
Switch units for electronic operating devices with 1-10 V interface	57
Start-up switches	58-59
Electronic discharge units	60
Technical details for discharge lamps	78-119
General technical details	348-356
Glossary	357-359

Electronic Superimposed Ignitors for HS Lamps up to 70 W

Standard version or with automatic switch-off
 For high pressure sodium lamps (HS) and ceramic discharge lamps C-HI-TT/ET with base E27
 Phasing of the ignition voltage:
 60–90 °el and 240–270 °el
 Max. permitted casing temperature: 105 °C
 Fastening: male nipple with pre-assembled washer and nut
 For luminaires of protection class I and II

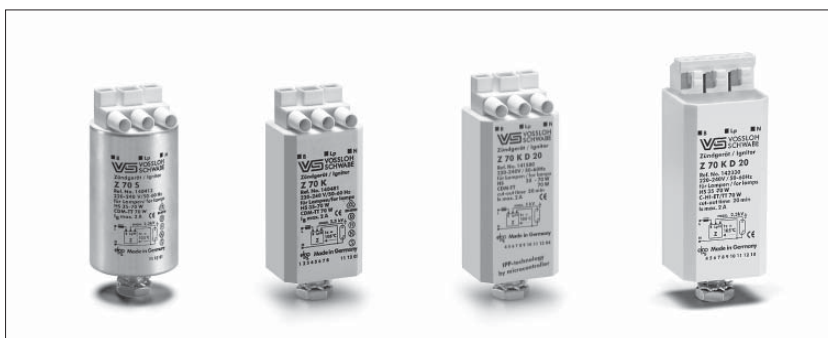

Al casing

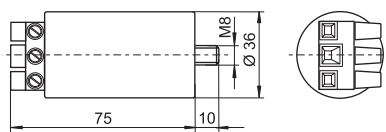

PC casing - K

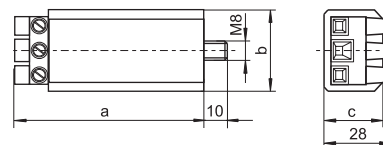

PC casing - K D20

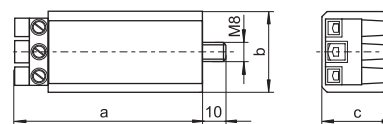

PC casing - with push-in terminals

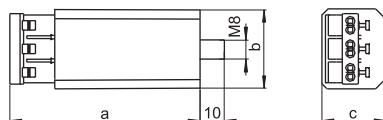

Type	Ref. No.	Voltage AC 50–60 Hz V	Max. lamp A	Internal loss W	Inherent heating K	Ignition voltage kV	Load capacity pF	Switch-off time sec./Hz	Casing d (∅) mm	a mm	b mm	c mm	Weight g
Aluminium casing (Al) with screw terminals: 0.75–4 mm²													
Z 70 S	140413	220–240	2	< 0.6	< 5	1.8–2.3	20–200	—	35	76	—	—	135
Plastic casing (PC) with screw terminals: 0.75–4 mm²													
Z 70 K	140481	220–240	2	< 0.6	< 5	1.8–2.3	20–200	—	—	78	34	27	125
Z 70 K D20	141580*	220–240	2	< 0.6	< 5	1.8–2.3	20–100	1216/50–60	—	80	34	30	145
Plastic casing (PC) with push-in terminals: 0.5–2.5 mm²													
Z 70 K D20	142330*	220–240	2	< 0.6	< 5	1.8–2.3	20–100	1216/50–60	—	83	34	30	145

* With IPP technology

Electronic Superimposed Ignitors for HS Lamps 70 (DE) to 250 W and HI Lamps 35 to 250 W

Standard version or with automatic switch-off
 For high pressure sodium lamps (HS),
 metal halide lamps (HI) and
 ceramic discharge lamps (C-HI)
 Phasing of the ignition voltage:
 60–90 °el and 240–270 °el
 Max. permitted casing temperature: 105 °C
 Fastening: male nipple with pre-assembled
 washer and nut
 For luminaires of protection class I and II



Al casing

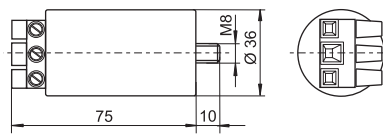

PC casing – K

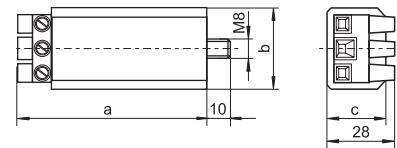

PC casing – K D20

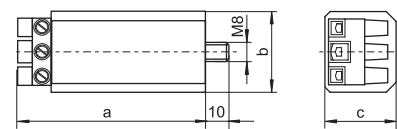

PC casing – with push-in terminals

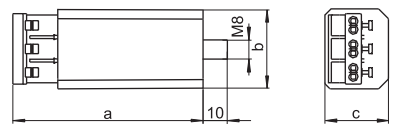

Type	Ref. No.	Voltage AC 50–60 Hz V	Max. lamp current A	Internal loss W	Inherent heating K	Ignition voltage kV	Load capacity pF	Switch-off time sec./Hz	Casing d (∅) mm	a mm	b mm	c mm	Weight g
Aluminium casing (Al) with screw terminals: 0.75–4 mm²													
Z 250 S	140425	220–240	3.5	< 1.8	< 20	4–5	20–100	—	35	76	—	—	140
Plastic casing (PC) with screw terminals: 0.75–4 mm²													
Z 250 K	140489	220–240	3.5	< 1.8	< 20	4–5	20–100	—	—	78	34	27	130
Z 250 K D20	141581*	220–240	3.5	< 1.8	< 20	4–5	20–100	1216/50–60	—	80	34	30	145
Plastic casing (PC) with push-in terminals: 0.5–2.5 mm²													
Z 250 K D20*	142350*	220–240	3.5	< 1.8	< 20	4–5	20–100	1216/50–60	—	83	34	30	145

* With IPP technology

Electronic Superimposed Ignitors for HS Lamps 70 (DE) to 400 W and HI Lamps 35 to 400 W



Standard version or with automatic switch-off
 For high pressure sodium lamps (HS),
 metal halide lamps (HI) and
 ceramic discharge lamps (C-HI)
 Phasing of the ignition voltage:
 60–90 °el and 240–270 °el
 Max. permitted casing temperature: 105 °C
 Screw terminals: 0.75–4 mm²
 Fastening: male nipple with pre-assembled
 washer and nut
 For luminaires of protection class I and II

Al casing

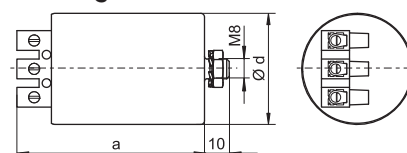

Type	Ref. No.	Voltage AC 50–60 Hz V	Max. lamp current A	Internal loss W	Inherent heating K	Ignition voltage kV	Load capacity pF	Switch-off time sec./Hz	Casing			Weight g	
									d (Ø) mm	a mm	b mm		c mm
Z 400 S	140427	220–240	5	< 3	< 25	4–5	20–100	—	45	76	—	—	250
Z 400 S D20	141583*	220–240	5	< 3	< 25	4–5	20–100	1216/50–60	45	90	—	—	280

* With IPP technology

Electronic Superimposed Ignitors for HS Lamps 70 (DE) to 400 W and HI Lamps 35 to 400 W

Standard version or with automatic switch-off
Compact shape
For high pressure sodium lamps (HS), metal halide lamps (HI) and ceramic discharge lamps (C-HI)
Ignition voltage: 4–5 kV
Phasing of the ignition voltage: 60–90 °el and 240–270 °el
Max. permitted casing temperature: 105 °C
Fastening: male nipple with pre-assembled washer and nut
For luminaires of protection class I and II
For luminaires of protection class I (140594, 147707)

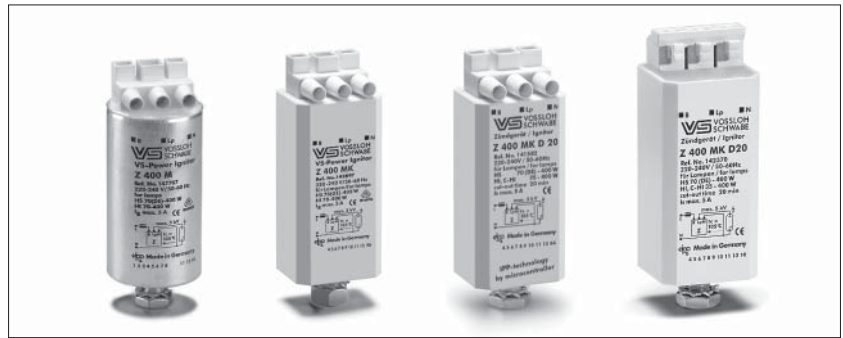

Al casing

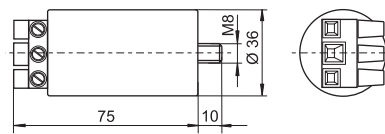

PC casing – K

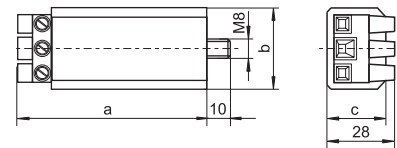

PC casing – K D20

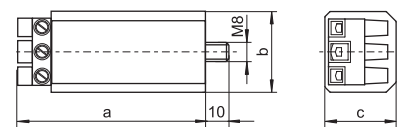

PC casing – with push-in terminals

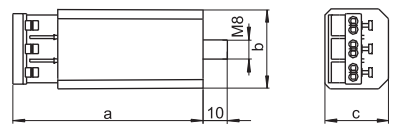

Type	Ref. No.	Voltage AC 50–60 Hz V	Max. lamp current A	Internal loss W	Inherent heating K	Ignition voltage kV	Load capacity pF	Switch-off time sec./Hz	Casing d (∅) mm	a mm	b mm	c mm	Weight g
Aluminium casing (Al) with screw terminals: 0.75–4 mm²													
Z 400 M	140594	220–240	5	< 3	< 35	4–5	20–50	—	35	76	—	—	140
Z 400 M VS-Power	147707**	220–240	5	< 3	< 35	4–5	20–50	—	35	76	—	—	140
Z 400 M S	140693	220–240	5	< 3	< 35	4–5	20–50	—	35	76	—	—	140
Plastic casing (PC) with screw terminals: 0.75–4 mm²													
Z 400 M K	140597	220–240	5	< 3	< 35	4–5	20–50	—	—	78	34	27	130
Z 400 M K VS-Power	142897**	220–240	5	< 3	< 35	4–5	20–50	—	—	78	34	27	130
Z 400 M K D20	141582*	220–240	5	< 3	< 35	4–5	20–50	1216/50–60	—	80	34	30	145
Plastic casing (PC) with push-in terminals: 0.5–2.5 mm²													
Z 400 M K D20	142370*	220–240	5	< 3	< 35	4–5	20–50	1216/50–60	—	83	34	30	145

Recommended for outdoor lighting

* With IPP technology

** Not suitable for C-HI lamps

Electronic Superimposed Ignitors for HS Lamps 600 and 750 W

Standard version

For high pressure sodium lamps (HS)

Phasing of the ignition voltage:

60–90 °el and 240–270 °el

Max. permitted casing temperature: 105 °C

Screw terminals: 0.75–4 mm²

Fastening: male nipple with pre-assembled washer and nut

For luminaires of protection class I and II



Al casing

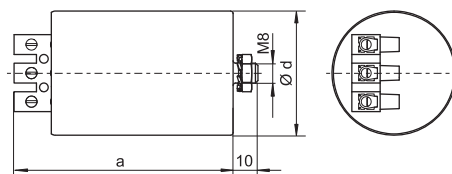

Type	Ref. No.	Voltage AC 50–60 Hz V	Max. lamp current A	Internal loss W	Inherent heating K	Ignition voltage kV	Load capacity pF	Switch-off time sec./Hz	Casing				Weight g
									d (Ø) mm	a mm	b mm	c mm	
Aluminium casing (Al)													
Z 750 S	146990	220–240	8	< 3	< 20	4–5	20–100	—	50	90	—	—	360

Electronic Superimposed Ignitors for HS and HI Lamps 250 to 1000 W

Standard version or with automatic switch-off
 For high pressure sodium lamps (HS)
 and metal halide lamps (HI)
 Phasing of the ignition voltage:
 60–90 °el and 240–270 °el
 Max. permitted casing temperature: 105 °C
 Screw terminals: 0.75–2.5 mm²
 (Z 1000 S: 0.75–4 mm²)
 Fastening: male nipple with pre-assembled
 washer and nut
 For luminaires of protection class I and II

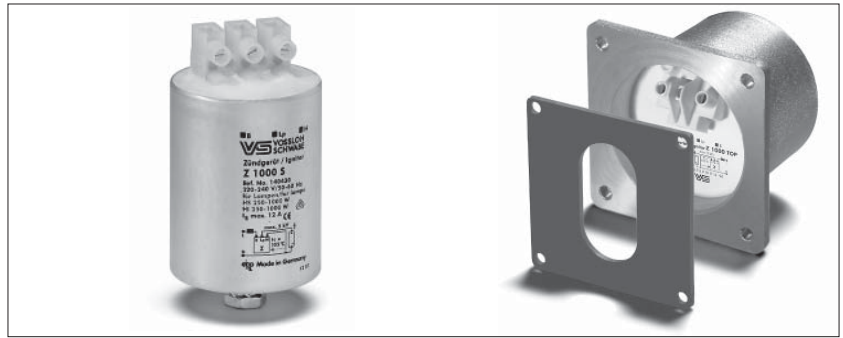

Al casing

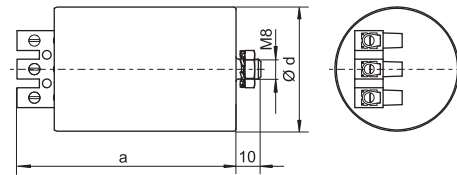

Z 1000 TOP

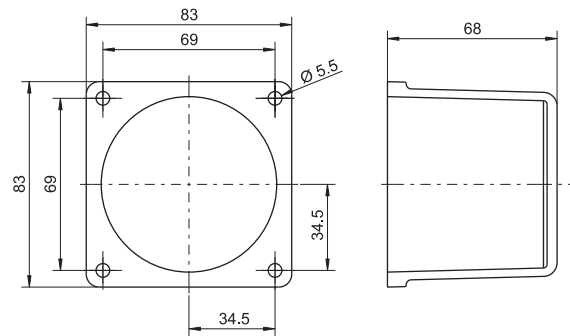

Type	Ref. No.	Voltage AC 50–60 Hz V	Max. lamp current A	Internal loss W	Inherent heating K	Ignition voltage kV	Load capacity µF	Switch-off time sec./Hz	Casing			Weight g	
									d (Ø) mm	a mm	b mm		c mm
Aluminium casing (Al)													
Z 1000 S	140430	220–240	12	< 6	< 35	4–5	20–100	—	50	80	—	—	340
Z 1000 TOP	140607**	220–240	12	< 6	< 35	4–5	20–100	—	—	83	83	68	620
Z 1000 S D20	141584*	220–240	12	< 6	< 35	4–5	20–100	1216/50–60	50	80	—	—	340

* With IPP technology

** For flange-mounting with gasket for degree of protection IP55

1

2

3

4

5

6

7

8

9

10

Electronic Superimposed Ignitors for HS and HI Lamps up to 1000 W



Standard version

For high pressure sodium lamps (HS) and metal halide lamps (HI)

For long lead lengths

Max. permitted casing temperature: 105 °C

Screw terminals: 0.75–2.5 mm²

Fastening: male nipple with pre-assembled washer and nut

Al casing

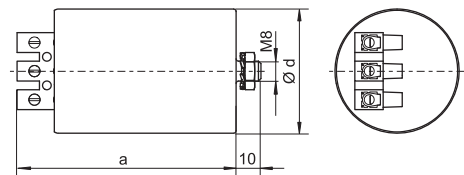

For HS and HI lamps 150 to 1000 W

Phasing of the ignition voltage: 60–90 °el

For luminaires of protection class I

Type	Ref. No.	Voltage AC 50–60 Hz V	Max. lamp current A	Internal loss W	Inherent heating K	Ignition voltage kV	Load capacity pF	Switch-off time sec./Hz	Casing				Weight g
									d (∅) mm	a mm	b mm	c mm	
Aluminium casing (Al)													
Z 1000 L	140471*	220–240	12	< 6	< 35	4–5	20–2000	—	50	97	—	—	340

* Not suitable for HI lamps types NDL, WDL or for HS lamps types S, de-Luxe, Comfort or similar

For HS lamps 600 to 1000 W/400 V and HI lamps 1000 W/400 V

Phasing of the ignition voltage:

60–90 °el and 240–270 °el

For luminaires of protection class I and II

Type	Ref. No.	Voltage AC 50–60 Hz V	Max. lamp current A	Internal loss W	Inherent heating K	Ignition voltage kV	Load capacity pF	Switch-off time sec./Hz	Casing				Weight g
									d (∅) mm	a mm	b mm	c mm	
Aluminium casing (Al)													
Z 1000 S/400 V	140496	380–415	6	< 3.3	< 28	4–5	20–2000	—	45	84	—	—	295

Electronic Superimposed Ignitors for Projection Lamps up to 1200 W

Standard version

For high-pressure discharge lamps

Phasing of the ignition voltage:

60–90 °el and 240–270 °el

Max. permitted casing temperature: 105 °C

Screw terminals: 0.75–2.5 mm²

Fastening: male nipple with pre-assembled washer and nut

For luminaires of protection class I



Al casing

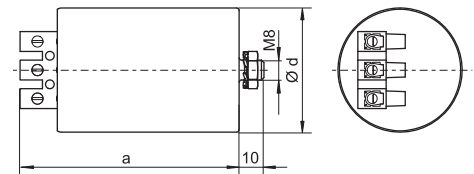

Type	Ref. No.	Voltage AC 50–60 Hz V	Max. lamp current A	Internal loss W	Inherent heating K	Ignition voltage kV	Load capacity pF	Switch-off time sec./Hz	Casing				Weight g
									d (∅) mm	a mm	b mm	c mm	
Aluminium casing (Al)													
Z 1200/2.5	140608*	220–240	15	< 7.5	< 40	2–2.5	20–200	—	50	80	—	—	330
Z 1200/9	140609**	220–240	15	< 10	< 40	7–8	20–50	—	50	135	—	—	650

* For lamps, e.g. HSR, MSR, SN

** For lamps, e.g. HMI, HTI, CDI, RSI, CSR

Electronic Superimposed Ignitors for HI Lamps up to 3500 W

Standard version

For metal halide lamps (HI)

Phasing of the ignition voltage:

60–90 °el and 240–270 °el

Max. permitted casing temperature: 105 °C

Screw terminals: 0.75–2.5 mm²

Fastening: male nipple with pre-assembled washer and nut

For luminaires of protection class I and II

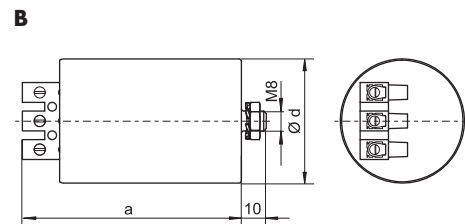
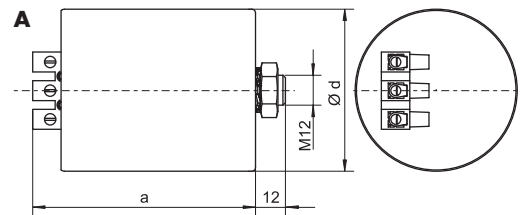

Type	Ref. No.	Voltage AC 50–60 Hz V	Max. lamp current A	Internal loss W	Inherent heating K	Ignition voltage kV	Load capacity pF	Switch-off time sec./Hz	Drawing	Casing			Weight g	
										d (Ø) mm	a mm	b mm		c mm
Aluminium casing (Al)														
Z 2000 S	140432	220–240	20	< 6	< 30	4–5	20–100	—	A	65	96	—	—	640
Z 2000 S/400 V	140497	380–415	12.7	< 5	< 32	4–5	20–2000	—	B	50	88	—	—	340
Z 3500 S/400 V	140499	380–415	20	< 7	< 35	4–5	20–100	—	A	65	96	—	—	650

Pulse Ignitors for HS and HI Lamps up to 1000 W

With automatic switch-off
 For high pressure sodium lamps (HS),
 metal halide lamps (HI) and
 ceramic discharge lamps (C-HI)
 Max. permitted casing temperature: 95 °C
 Screw terminals: 0.75–2.5 mm²
 Fastening: male nipple with pre-assembled
 washer and nut
 For luminaires of protection class I
 This pulse ignitor is only for use with ballasts that
 have a dedicated tapping, as this determines the
 size of the ignition voltage.



Al casing

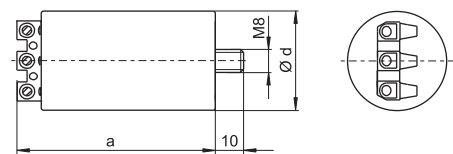

PC casing

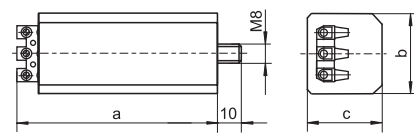

For HS lamps 50 to 1000 W, HI lamps 35 to 1000 W and C-HI lamps 35 to 400 W

Type	Ref. No.	Voltage AC 50–60 Hz V	Number of ignition pulses per mains period	Ignition voltage kV	Load capacity pF	Programmed switch-off time sec./Hz	Casing			Weight g
							a mm	b mm	c mm	
Plastic casing (PC)										
PZ 1000 K D20	142784*	220–240 ±10%	≥ 2	1.8–2.3/4–5	20–1000	1216/50–60	74	34	27	100

With IPP technology

* Suitable ballasts (type: NaHJ...PZT) are available on request

For HS lamps 600 to 1000 W/400 V and HI lamps 1000 W/400 V

Type	Ref. No.	Voltage AC 50–60 Hz V	Number of ignition pulses per mains period	Ignition voltage kV	Load capacity pF	Programmed switch-off time sec./Hz	Casing d (Ø) mm	a mm	b mm	c mm	g	Weight g
PZ 1000/400 V A5	142783*	380–420	≥ 1	4–5	20–800	300/50	40	80	—	—	—	155

* Suitable ballasts (type: NaHJ...PZT) are available on request

- 1
- 2
- 3
- 4
- 5
- 6
- 7
- 8
- 9
- 10

Pulse Ignitors for HS Lamps 50 to 1000 W

Standard version

For standard high pressure sodium lamps (HS)

Max. permitted casing temperature: 95 °C

Screw terminals: 0.5–1.5 mm²

Fastening: male nipple with pre-assembled washer and nut

For luminaires of protection class I

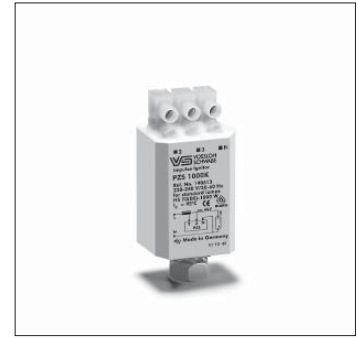
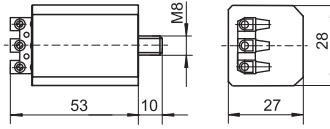

Type	Ref. No.	Voltage AC 50–60 Hz V	Number of ignition pulses per mains period	Ignition voltage kV	Load capacity pF	Programmed switch-off time sec.	Casing				Weight g
							d (∅) mm	a mm	b mm	c mm	
Plastic casing (PC)											
PZS 1000 K	140613	220–240	approx. 1/sec.	approx. 4	20–4000	—	—	50	28	27	50

Not suitable for HS lamps types Plus, Super, XL, HO

Suitable ballasts (type: NaH...P) are available on request

Pulse Ignitors for HI Lamps 250 to 2000 W, Ignition Voltage up to 1 kV

Standard version

For metal halide lamps (HI)

with ignition voltage of 0.9 kV

Max. permitted casing temperature: 95 °C

Screw terminals: 0.5–2.5 mm²

Fastening: male nipple with pre-assembled washer and nut

For luminaires of protection class I

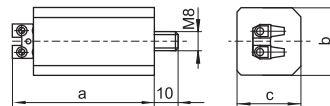

Type	Ref. No.	Voltage AC 50–60 Hz V	Number of ignition pulses per mains period	Ignition voltage kV	Load capacity pF	Programmed switch-off time sec.	Casing			Weight g
							a mm	b mm	c mm	
Plastic casing (PC)										
PZI 1000/1 K	140617	220–240	≥ 1	0.7–0.9	max. 10000	—	57	28	27	50

Suitable ballasts see page 31, 32 and 33

Instant Restrike Ignitors for High-pressure Discharge Lamps up to 600 W

For high pressure sodium lamps (HS), metal halide lamps (HI), ceramic discharge lamps (C-HI) and projection lamps in accordance with the lamp table shown below
For installation as a symmetric ignition device (whereby the ignition voltage is split equally over both lamp electrodes)

For installation in luminaires of protection class I
Max. permitted ambient temperature t_a : 60 °C
Mains connection: screw terminal 3-poles, 0.75–2.5 mm²

Lamp connection: screw terminal 0.75–2.5 mm² for circuit 1 and 2

Fastening: 2 mounting slots for screws M4
Material: plastic casing made of ABS

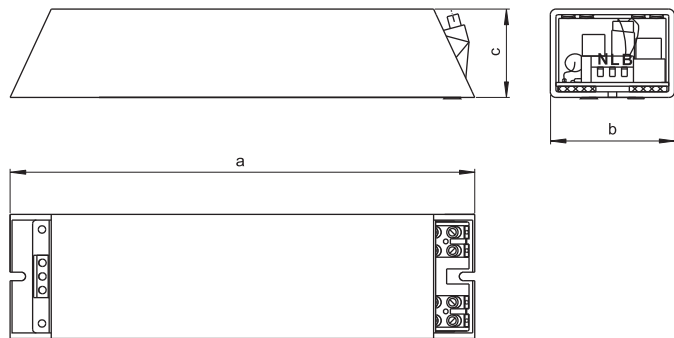

Circuit 1

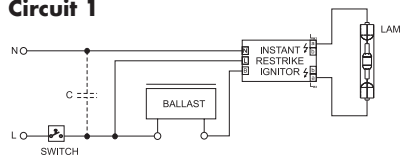

Circuit 2

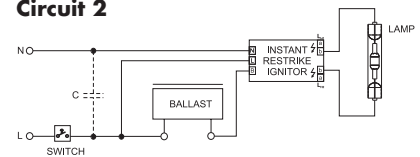

CAUTION

Defective lamps must be replaced immediately

Type	Ref. No.	Voltage AC 50–60 Hz V	Max. lamp current A	Internal loss W	Inherent heating K	Ignition voltage* kV	Ignition time sec.	Load capacity pF	Casing			Weight g
									a mm	b mm	c mm	
HZ 600 K	147790	230 ±10%	8	< 4	< 10	20–30	approx. 6	5–30	247	66	47	1000

* Depending on the respective circuit, the ignition voltage is split equally over both lamp electrodes

Lamp table							
Circuit 1				Circuit 2			
Lamp type	Base	VS lampholder type	Catalogue page	Lamp type	Base	VS lampholder type	
CDM-TD 70 W	RX7s	306	77	HBO 50 W	SFa8-2	—	
HCI-TS 70 W	RX7s	306	77	MSR 125 HR	GZX9.5	—	
HI 70 W (DE)	RX7s	306	77	HBO 200 W	SFc10-4	—	
HS 70 W (DE)	RX7s	306	77	HBO 200 W	SFc10-4	—	
RCI-TS 70 W	RX7s	306	77	MSR 200 HR	GZX9.5	—	
HS 150 W (DE)	RX7s	306	77	HTI 250 W	FaX1.5	—	
HMI 200 W	X515	—		HMI 400 W/SE	GZZ9.5	—	
HMI 200 W/X	GZY9.5	—		HMP 400 W	FaX1.5	—	
MSI 200 W	GZY9.5	—		HTI 400 W	FaX1.5	—	
RSI 200 W	X515	—		RSI 400 W	GZX9.5	—	
HS 250 W (DE)	Fc2	025	77–78	HBO 500 W	SFcY13-5	—	
HS 400 W (DE)	Fc2	025	77–78	HMP 575 W	SFc10-4 / G22	—	
MSR 400 HR	GZZ9.5	—		HMI 575 W	SFc10-4	—	
MSI 575 W	SFc10	—		RSI 575 W	G22	—	
MSR 575 HR	G22	—		HTI 600 W	FaX1.5	—	

Instant Restrike Ignitors for High-pressure Discharge Lamps 1000 W/230 V and 2000 W/400 V

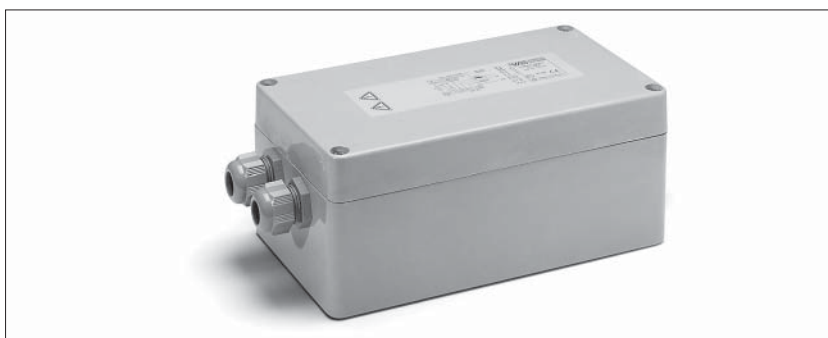

For high pressure sodium lamps (HS), metal halide lamps (HI), ceramic discharge lamps (C-HI) in accordance with the lamp table shown below
For installation as a symmetric ignition device (whereby the ignition voltage is split equally over both lamp electrodes)

Degree of protection: IP65

For installation in luminaires of protection class I

Max. permitted ambient temperature t_a : 60 °C

Mains connection: screw terminal 3-poles, max. 4 mm²

Earth connection: screw terminal max. 4 mm²

Lamp connection: screw terminal max. 4 mm²

Fastening: 4 holes Ø 6.3 mm in the base of casing

Material: casing made of fibreglass-reinforced polyester

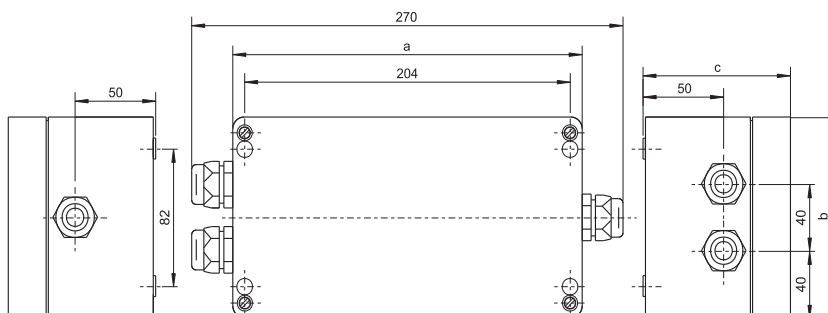

Circuit diagram HZ 1000 K/230V

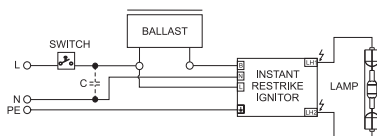

Circuit diagram HZ 2000 K/400 V

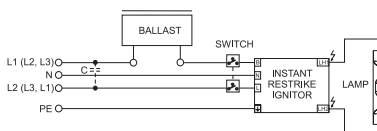

CAUTION

Defective lamps must be replaced immediately

Type	Ref. No.	Voltage AC 50–60 Hz V	Max. lamp current A	Internal loss W	Inherent heating K	Ignition voltage* kV	Ignition time sec.	Load capacity pF	Casing			Weight g
									a mm	b mm	c mm	
HZ 1000 K	147791	230 ±10%	12	< 5	< 10	36	approx. 6	5–50	218	120	92	3745
HZ 2000 K/400 V	147793	400 ±10%	12.7	< 5	< 10	36	approx. 6	5–30	218	120	92	3745

* The ignition voltage is split equally over both lamp electrodes

Lamp table HZ 1000 K

Lamp type	Lamp manufacturer	Base	VS lampholder type	Catalogue page	Lamp type	Base	VS lampholder type	Catalogue page
CDM-TD 150 W	Philips	RX7s	306	77	HI 400 W (DE)	Fc2	025	77–78
HCI-TS 150 W	Osram	RX7s	306	77	HS 400 W (DE)	Fc2	025	77–78
HI 150 W (DE)		RX7s	306	77	HI 1000 W (DE)	Fc2	025	77–78
HS 150 W (DE)		RX7s	306	77	HS 1000 W (DE)	Cable, K12s-7	211	79
HI 250 W (DE)		Fc2	025	77–78	—	—	—	—
HS 250 W (DE)		Fc2	025	77–78	—	—	—	—

Lamp table HZ 2000 K/400 V

Lamp type	Base	VS lampholder type	Catalogue page	Note
HI 2000 W (DE)	Cable, K12s-7	211	79	not suitable for HRI-TS 2000 W/N/L, HQ-TS 2000 W/N/L

Electronic Power Switches for HS Lamps up to 600 W and HM Lamps up to 700 W



For high pressure sodium lamps (HS) and mercury vapour lamps (HM)
 For power reduction by using ballasts with multiple voltage tapping and superimposed ignitors
 PR 12 K LC and PR 12 K D are also suitable for power switching of LED drivers and electronic ballasts.
 Casing: PC
 Max. permitted casing temperature t_c : 80 °C
 Screw terminals: 0.75–2.5 mm²
 Fastening: male nipple with pre-assembled washer and nut
 For luminaires of protection class I and II
 Circuit diagrams for power reduction see pages 96–97.

PU 12 K/PR 12 KD/PR 12 K LC

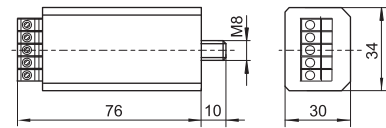

PU 120 K

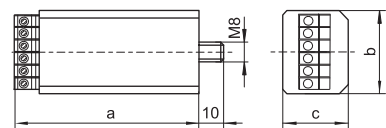

PU 121 K

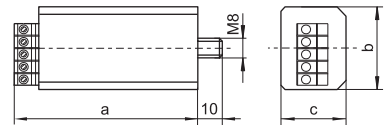

Advantages of PR 12 K LC

- intelligent, auto-adaptive concept
- eliminates the time-consuming task of continually adjusting the times of power-reduced operation to suit constantly changing day-night cycles
- removes the need for making adjustments due to daylight-saving times
- easy programming via dial
- no additional control line necessary
- optimal suitable for the supplementary integration into existing luminaires
- suitable for luminaires of protection class I and II

Type	Ref. No.	Voltage AC V, Hz	Max. contact current		Inherent heating K	Integrated delay switching	Control phase for power reduction (circuitry logic)	Casing			Weight g
			A/λ	A/λ				a mm	b mm	c mm	
Power reduction with control phase											
PU 12 K	140621	230, 50 / 220, 60	8/0.5	12/1	< 25	—	disconnect or connect	74	34	27	100
PU 120 K	140622*	230, 50 / 220, 60	8/0.5	12/1	< 10	327 sec.	disconnect	74	34	27	100
PU 121 K	140623*	230, 50 / 220, 60	8/0.5	12/1	< 25	327 sec.	connect	74	34	27	100
Power reduction without control phase											
PR 12 K LC****	142170**	220–230 ±10%, 50 220 ±10%, 60	8/0.5	12/1	< 12	selectable	without control phase	76	34	31	100
PR 12 K D****	142150***	220–230 ±10%, 50 220 ±10%, 60	8/0.5	12/1	< 12	selectable	without control phase	76	34	31	100

* For full-load lamp start

** Time of power-reduced operation selectable, starting point of switching-time changes automatically to suit constantly changing day-night cycles

*** Power reduction after a constant switching-time (delay switching); switching-time selectable: 3 | 3.5 | 4 | 4.5 | 5 | 5.5 | 6 hrs at 50 Hz

**** 120–240 V ±10% on request

Electronic Superimposed Ignitors with Power Switch for HS Lamps 50 to 250 W

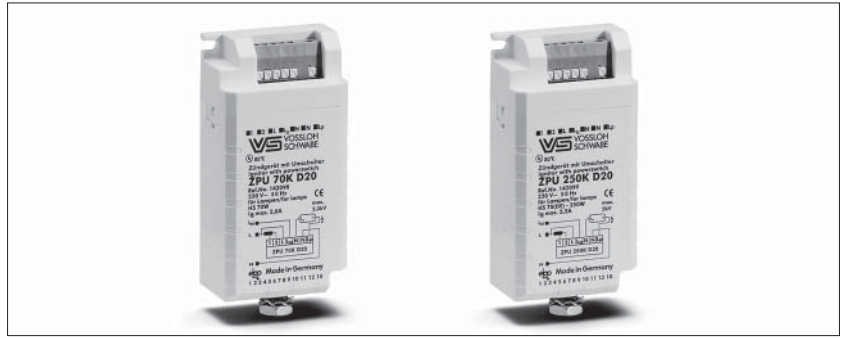

For ignition and power reduction of high pressure sodium lamps (HS)

Casing: PC

Control voltage: 230 V $\pm 10\%$

Response/cut-out voltage: 170–198 V

Phasing of the ignition voltage:

60–90 °el and 240–270 °el

Max. permitted casing temperature t_c : 80 °C

Push-in terminals: 0.75–1.5 mm²

Fastening: male nipple with pre-assembled washer and nut

For luminaires of protection class I and II

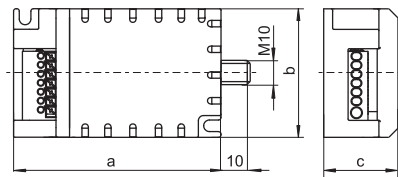

Applicable for positive switch logic allowing for terminal pin assignment of power switch

- Full load lamp start is guaranteed
- Switching to power reduced operation after delay time of approx. 5 min.

Type	Ref. No.	Voltage AC V, Hz	Max. lamp current A	Number of ignition pulses per mains period	Internal loss W	Inherent heating K	Ignition voltage kV	Load capacity pF	Programmed switch-off time sec./Hz	Casing			Weight g
										a	b	c	
HS lamps 50 and 70 W													
ZPU 70 K D20	142098	230, 50/220, 60	2	4	< 2	< 15	1.8–2.3	20–200	1216/50–60	96	50	32	240
HS lamps 70 (DE) to 250 W													
ZPU 250 K D20	142099	230, 50/220, 60	3	6	< 2	< 15	4–5	20–50	1216/50–60	96	50	32	240

Circuit diagrams see page 95

Switch Units for Electronic Operating Devices with 1-10 V Interface

Vossloh-Schwabe's switch units are designed to enable one-step power reduction of lamps (FL, CFL, LED, HS, HI and C-HI) with the help of the respective electronic ballast or converter.

To this end, the switch unit utilises the 1-10 V interface of the control gear unit. The switch unit is mainly intended for outdoor luminaires in systems with or without a control phase.

Shape: 56x28x27 mm

Casing: PC

Screw terminals: 0.75-2.5 mm²

Max. permissible casing temperature t_c : 80 °C

Min. permissible ambient temperature t_a : -30 °C

Fastening: plastic male nipple with pre-assembled washer and nut

Power reduction SU 1-10 V K for lighting systems featuring an LST control phase

The switch unit employs a positive switching to reduce power, i.e. power is reduced when the control phase is switched off ($L_{ST} = 0$ V).

The 1-10 V interface of the electronic ballast is addressed at the moment that power reduction is effected.

Power reduction PR 1-10 V K LC for lighting systems without a control phase

This switch unit can be used to effect power reduction in lighting systems that do not feature a control phase.

The 1-10 V interface is addressed on the basis of the fundamental operating principle used by Vossloh-Schwabe's PR 12 K LC power switch (details of which can be made available on request). This power switch is capable of determining the starting time of reduced-power operation over the measured operating time of a lighting system. As a result, it is no longer necessary to spend valuable time modifying the power-reduction unit to suit the continually changing day-night cycle; changing the clocks in line with daylight saving measures in the summer and winter is equally unnecessary. The 1-10 V interface of the electronic ballast is addressed as soon as the system is switched to reduced power.

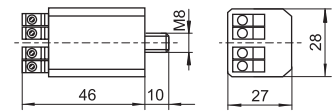

Circuit diagram SU 1-10 V K

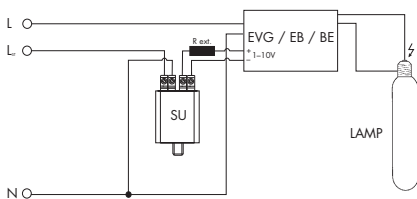

Circuit diagram PR 1-10 V K LC

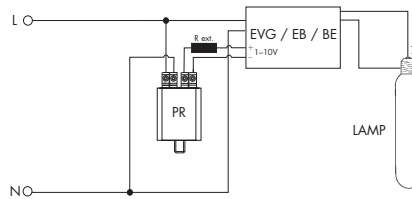

Type	Ref. No.	Control voltage L _{ST} V, 50/60 Hz	Externally (on site) connected resistor (R _{ext.}) kΩ (min. 0.1 W)	Self-heating K	Weight g
For lighting systems with control phase					
SU 1-10 V K	149992	220-240 V ±10%	1-70	< 10	50
For lighting systems without control phase					
PR 1-10 V K LC	149993	—	1-70	< 10	50

Start-up Switches for HS and HI Lamps 35 to 1000 W and HM Lamps 50 to 700 W

To bridge a phase of darkness during the starting-up period of high-pressure discharge lamps and also after a brief interruption of the power supply until the high-pressure discharge lamps are restarted

For mercury vapour lamps (HM), high-pressure sodium lamps (HS), metal halide lamps (HI) and ceramic discharge lamps (C-HI)
For HS, HI and C-HI lamps only if used together with a superimposed ignitor

Nominal voltage/frequency:
220–230 V ± 10%/50–60 Hz
240 V ± 10%/50 Hz

Max. permitted casing temperature t_c : 85 °C

Screw terminals: 0.75–2.5 mm²

Fastening: male nipple with pre-assembled washer and nut

Max. wattage of incandescent lamp: 1000 W

Automatic switch-off at 60% of the discharge lamp's luminous flux

During the ignition and start-up period, the start-up switch activates an incandescent lamp to provide a basic level of lighting. After a brief interruption in the supply voltage during the re-ignition of the discharge lamp, the integrated control electronics also bridges the phase of darkness by switching on the auxiliary lighting. The incandescent lamp is automatically switched off when the discharge lamp has achieved a sufficient luminous flux (approx. 60%).

Circuit for HM lamps

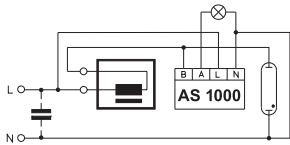

AS 1000 K

Casing: PC

Weight: 100 g

Internal loss: < 0.8 W

Inherent heating: < 10 K

Type: AS 1000 K

Ref. No.: 140627

Circuit for HS and HI lamps

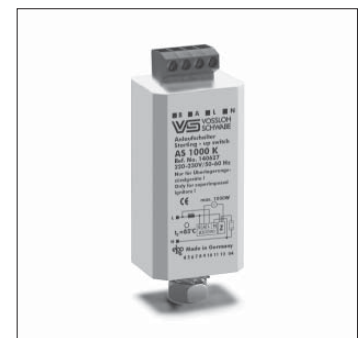
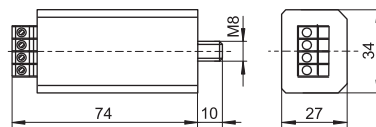
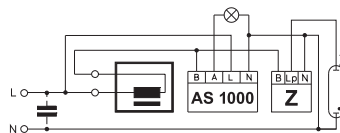

The time diagram shows some typical switching examples of a luminaire equipped with a high-pressure discharge lamp, incandescent lamp and start-up switch AS 1000 K.

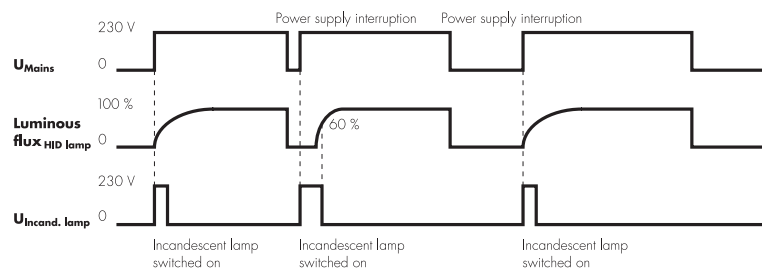

Ignitors and Accessories for Discharge Lamps

AS 1000 K A10

Specially for using with electronic ballasts or pulse ignitors for high-pressure discharge lamps

Casing: PC

Delayed switching: 655 sec. (50 Hz)

For luminaires of protection class I and II

Max. contact current: 6 A at λ 0.5, 10 A at λ 1

Internal loss: < 1 W

Inherent heating: < 12 K

Weight: 100 g

Type: AS 1000 K A10

Ref. No.: 141193

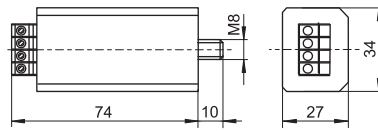

Circuit with electronic ballast

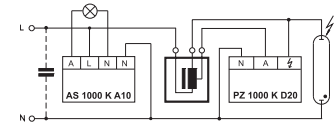
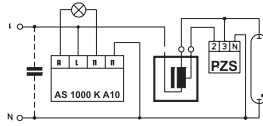
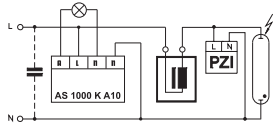
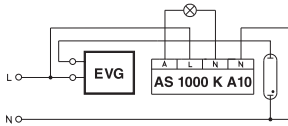

The time diagram shows some typical switching examples of a luminaire equipped with a high-pressure discharge lamp, incandescent lamp and start-up switch AS 1000 K A10.

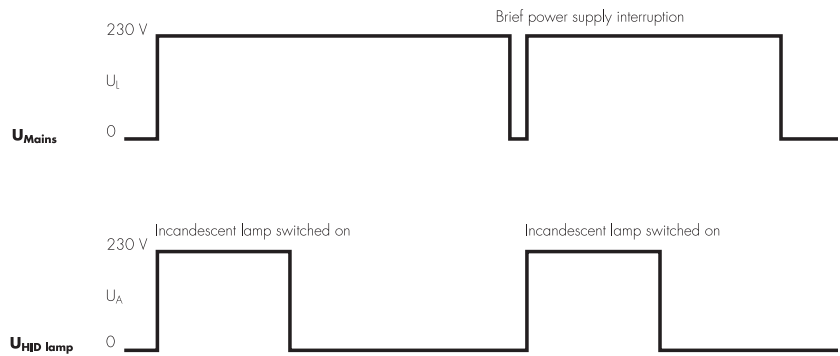

1

2

3

4

5

6

7

8

9

10

Electronic Discharge Units for Parallel Connected Capacitors 0.1 to 100 μF

On luminaires with parallel compensation and designed for plug connection to the mains supply, the plugs retain their charge for a relatively long time after disconnection from the power supply. The discharge resistors built into the compensation capacitor are designed for stationary lamps and when disconnected from the mains permit a voltage reduction to 50 V after 1 minute at the earliest.

According to European standard EN 60598-1, the compensation capacitor on mobile lamps must be discharged to 34 V within 1 second. Until now so-called discharge chokes built like conventional ballasts have been used for this purpose. These conventional discharge chokes are connected in parallel to the compensation capacitor and after disconnection from the power supply rapidly discharge the capacitor owing to their low ohmic resistance.

In their rated operating conditions, conventional discharge chokes exhibit a considerable inductive reactance which diminishes the effect of the compensation capacitor particularly if it has a low capacitance.

Furthermore, conventional discharge chokes cause considerable losses and feature high weight.

With the aid of the electronic discharge unit CE 50, it is possible to discharge a capacitor with a capacitance of up to 100 μF to 34 V within 1 second, i.e. within the time specified in EN 60598-1.

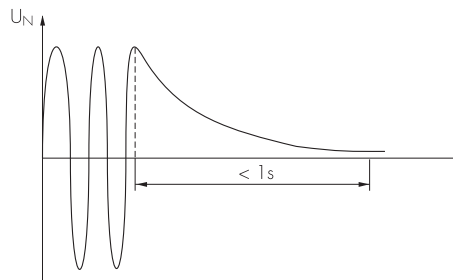

Thanks to its high reliability, low inherent losses, small dimensions and low weight, the CE 50 represents an inexpensive solution to the problem of capacitor discharge.

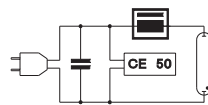

CE 50

All electronic, wear resistant switching element

Casing: aluminium

Nominal voltage: 34–264 V

Nominal frequency: 50–60 Hz

Internal loss: < 0.5 W

Inherent heating: < 6 K

Max. permitted casing temperature: 95 °C

Push-in terminals: 1 mm²

Fastening: male nipple with pre-assembled washer and nut

Weight: 40 g

Type: CE 50

Ref. No.: 140537

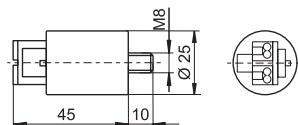

1

2

3

4

5

6

7

8

9

10

THERMOPLASTICS AND PORCELAIN



THE RIGHT MATERIAL MIX SPELLS A DECISIVE ADVANTAGE

The lampholders presented in this chapter are designed for high-pressure discharge lamps, for which high ignition voltages and high starting currents are characteristic. High temperatures can also occur with higher lamp outputs.

Vossloh-Schwabe therefore attaches great importance to ensuring casings, contacts and cables are made of high-grade materials.

Owing to the high ignition voltages, these lampholders are also governed by stricter requirements regarding creepage and air clearance distances.

When operating high-pressure discharge lamps with E27 and E40 Edison bases, care must be taken to ensure that the respective lampholders are approved for use with discharge lamps. Lampholders that are suitable in this respect are marked with "5 kV".

Lampholders with E26 and E39 bases and UL-approved wiring can be found under www.unvlt.com.



E27 lampholders	64-66
E40 lampholders	67-68
G8.5 lampholders	69
GU6.5 lampholders	69
GX10 lampholders	70
GY9.5 lampholders	71
G12 lampholders	71
RX7s lampholders	72-75
Fc2 lampholders	75-76
K12x30s lampholders	77
K12s-7 support	77
Technical details for discharge lamps	78-119
General technical details	348-356
Glossary	357-359

E27 Lampholders

For discharge lamps with base E27

E27 lampholders, for cover caps (see p. 291-293)
 Profiled shape, external thread 40x2.5 IEC 60399
 Nominal rating: 4/250/5 kV
 Push-in twin terminals: 0.5–2.5 mm²
 Fixing holes for screws M3
 Rear fixing holes for self-tapping screws
 acc. to ISO 1481/7049-ST3.9-C/F
 Weight: 15/16.5 g, unit: 500 pcs.
 Type: 64719

Ref. No.: 505721 PET GF, black, T210

Ref. No.: 505720 LCP, black, T270

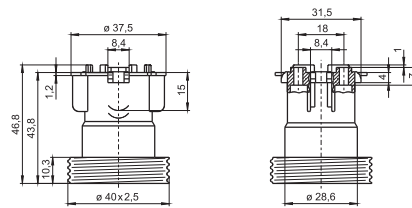

E27 lampholders, for cover caps (see p. 291-293)
 Profiled shape, plain
 Nominal rating: 4/250/5 kV
 Push-in twin terminals: 0.5–2.5 mm²
 Fixing holes for screws M3
 Rear fixing holes for self-tapping screws
 acc. to ISO 1481/7049-ST3.9-C/F
 Weight: 15 g, unit: 500 pcs.
 Type: 64770

Ref. No.: 505389 PET GF, black, T210

Ref. No.: 505014 LCP, black, T270

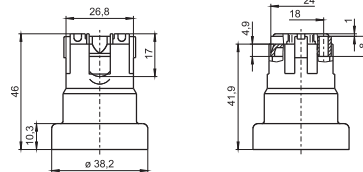

E27 lampholders
 Casing: PPS, black, T230
 Nominal rating: 4/500/5 kV
 Screw terminals: 0.5–2.5 mm²
 Spring loaded central contact
 Fixing holes for screws M4 and M5
 Weight: 35/35.4 g, unit: 250 pcs.
 Type: 62150

Ref. No.: 108718

Type: 62151 with lamp safety catch

Ref. No.: 108719

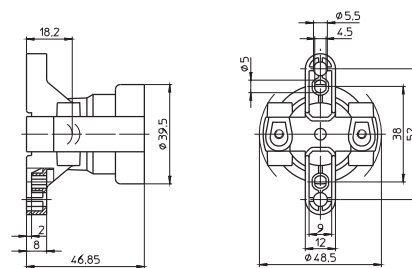

E27 lampholders
 Casing: porcelain, white, T210
 Nominal rating: 4/250/5 kV
 Screw terminals: 0.5–2.5 mm²
 Spring loaded central contact
 Oblong holes for screws M4
 Weight: 65/67.7 g, unit: 200 pcs.
 Type: 62600

Ref. No.: 102635

Type: 62601 with lamp safety catch

Ref. No.: 102637

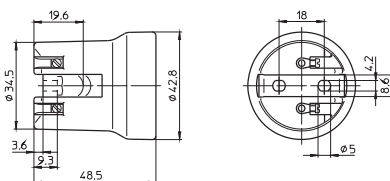

Lampholders for Discharge Lamps

E27 lampholder

Casing: porcelain, white, T210
 Nominal rating: 4/250/5 kV
 Screw terminals: 0.5–2.5 mm²
 Spring loaded central contact
 Threaded bushes for screws M3
 Weight: 69.3 g, unit: 200 pcs.
 Type: 62622

Ref. No.: 108416

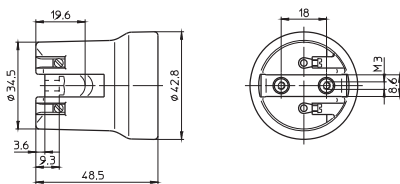

E27 lampholders

Casing: porcelain, white, T210
 Nominal rating: 4/250/5 kV
 Screw terminals: 0.5–2.5 mm²
 Spring loaded central contact
 Oblong holes for screws M4, length max. 15 mm
 Weight: 106.8/103.9 g, unit: 100 pcs.
 Type: 62104

Ref. No.: 102615

Type: 62105 with lamp safety catch

Ref. No.: 102617

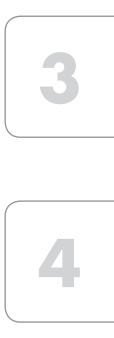
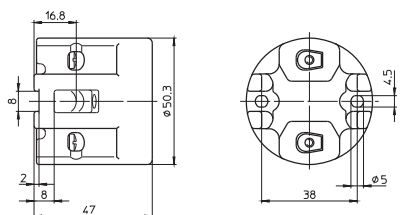

E27 lampholders

Casing: porcelain, white, T210
 Nominal rating: 4/250/5 kV
 Screw terminals: 0.5–2.5 mm²
 Spring loaded central contact
 Fixing bracket with slot for screws M5
 Weight: 113 g, unit: 100 pcs.
 Type: 62110

Ref. No.: 106585

Type: 62111 with lamp safety catch

Ref. No.: 109568

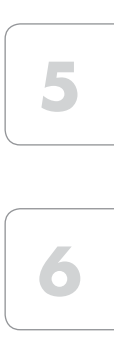
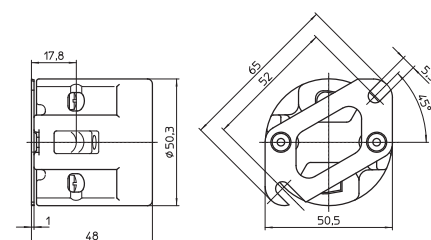

E27 lampholders

Casing: porcelain, white, T270
 Nominal rating: 4/250/5 kV
 Screw terminals: 0.5–2.5 mm²
 Spring loaded central contact
 Fixing oblong holes for screws M4
 Weight: 60.6 g, unit: 200 pcs.
 Type: 62050

Ref. No.: 102599

Type: 62010 with lamp safety catch (with spring)

Ref. No.: 102577

Type: 62009 with lamp safety catch (with crushing)

Ref. No.: 544605

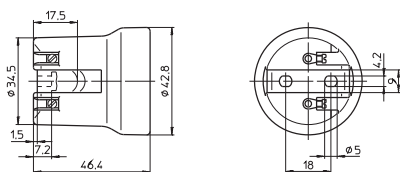

E27 lampholder

Casing: porcelain, white, T270
 Nominal rating: 4/250/5 kV
 Screw terminals: 0.5–2.5 mm²
 Spring loaded central contact
 Fastening bushes for screws M3
 Weight: 66.3 g, unit: 200 pcs.
 Type: 62015

Ref. No.: 102582

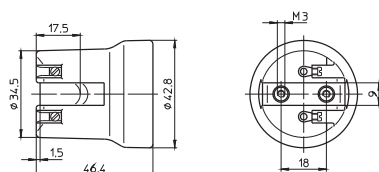

Lampholders for Discharge Lamps

E27 lampholder, one-piece
 Material: porcelain, white, T270
 Nominal rating: 4/250/5 kV
 Screw terminals: 0.5–2.5 mm²
 Spring loaded central contact
 Fixing oblong holes for screws M4
 Weight: 60.5 g, unit: 200 pcs.
 Type: 62070

Ref. No.: 543304

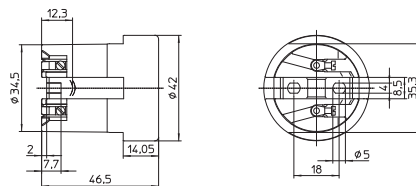

E27 lampholder
 Material: porcelain, white, T270
 Nominal rating: 4/250/5 kV
 Screw terminals: 0.5–2.5 mm²
 With lateral fixing flange,
 tilt angle: 15°
 Spring loaded central contact
 Fixing hole for screw M4
 Weight: 67.6 g, unit: 200 pcs.
 Type: 62415

Ref. No.: 543414

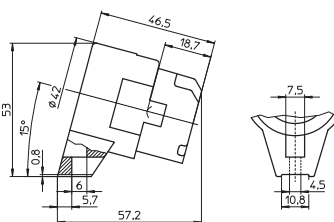

E27 lampholder, for cover caps (see page 291-293)
 Casing: porcelain, white, T270
 Nominal rating: 4/250/5 kV
 Screw terminals: 0.5–2.5 mm²
 Spring loaded central contact
 Fixing oblong holes for screws M4
 Weight: 66.5 g, unit: 150 pcs.
 Type: 62310

Ref. No.: 102624

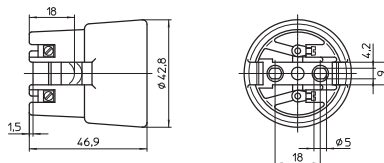

E27 lampholder
 For cover caps type 80010, 97735
 and 97742 (see page 299)
 Casing: porcelain, white, T270
 Nominal rating: 4/250/5 kV
 Screw terminals: 0.5–2.5 mm²
 Spring loaded central contact
 Fixing oblong holes for screw M4
 Weight: 66.5 g, unit: 200 pcs.
 Type: 62370

Ref. No.: 543303

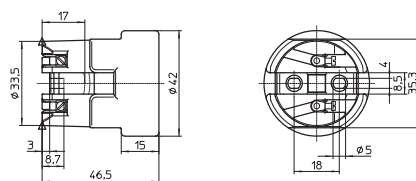

E40 Lampholders

For discharge lamps with base E40

Nominal rating: 18/500/5 kV

Screw terminals: 1.5–4 mm²

Spring loaded central contact

E40 lampholders

Casing: PPS, black, T240

Oblong holes for screws M5

Weight: 111.7/112.1 g, unit: 40 pcs.

Type: 12600/12601

Ref. No.: 400913

Ref. No.: 400914 with lamp safety catch

With steel thread

Ref. No.: 533428

Ref. No.: 533429 with lamp safety catch

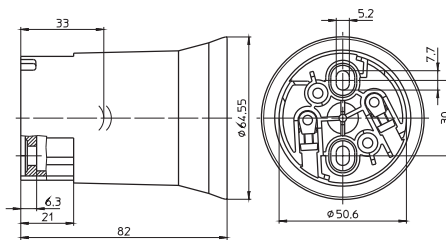

E40 lampholders

Casing: PPS, black, T240

Fixing bracket with slots for screws M5

Weight: 122.3/122.7 g, unit: 40 pcs.

Type: 12610/12611

Ref. No.: 400915

Ref. No.: 400916 with lamp safety catch

With steel thread

Ref. No.: 533430

Ref. No.: 533431 with lamp safety catch

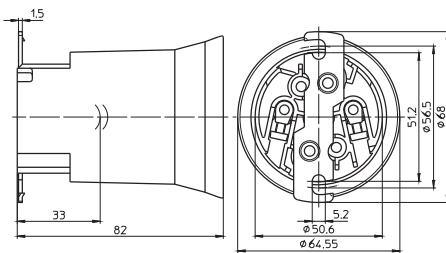

E40 lampholders

Casing: PPS, black, T240

Fixing bracket with tapped fixing holes M5

Weight: 122.9/123.3 g, unit: 40 pcs.

Type: 12614/12612

Ref. No.: 400917

Ref. No.: 400918 with lamp safety catch

With steel thread

Ref. No.: 536220

Ref. No.: 533432 with lamp safety catch

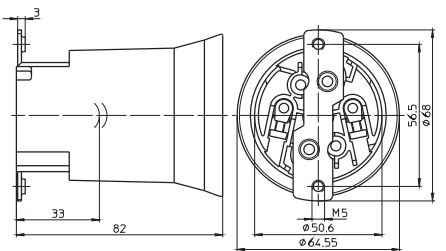

E40 lampholders

Casing: porcelain, white, T270

Oblong holes for screws M5

Weight: 224/229.3 g, unit: 48 pcs.

Type: 12800/12801

Ref. No.: 108208

Ref. No.: 107780 with lamp safety catch

With steel thread

Ref. No.: 532602

Ref. No.: 532603 with lamp safety catch

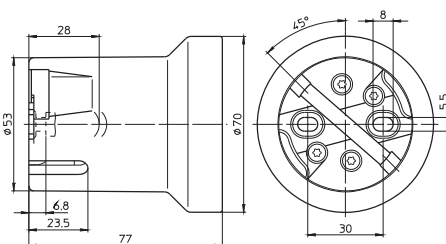

Lampholders for Discharge Lamps

E40 lampholders

Casing: porcelain, white, T270

Fixing bracket with slots for screws M5

Weight: 252.3/243 g, unit: 48 pcs.

Type: 12810/12811

Ref. No.: 108374

Ref. No.: 108375 with lamp safety catch

With steel thread

Ref. No.: 532604

Ref. No.: 532605 with lamp safety catch

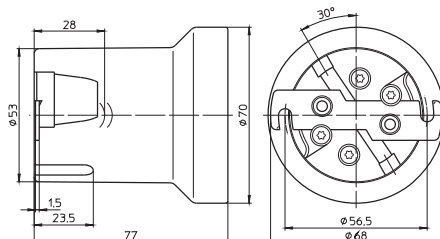

E40 lampholders

Casing: porcelain, white, T270

Fixing bracket with tapped fixing holes M5

With lamp safety catch

Weight: 252.8 g, unit: 48 pcs.

Type: 12812

Ref. No.: 108373

With steel thread

Ref. No.: 532606

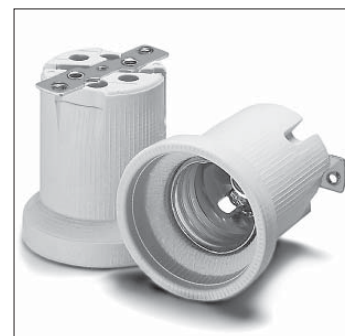
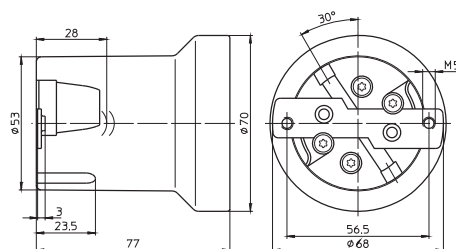

E40 lampholders

Only for lamps with base E40/E45

Casing: porcelain, white, T270

Oblong holes for screws M5

Weight: 206 g, unit: 50 pcs.

Type: 12900/12901

Ref. No.: 528252

Ref. No.: 528958 with lamp safety catch

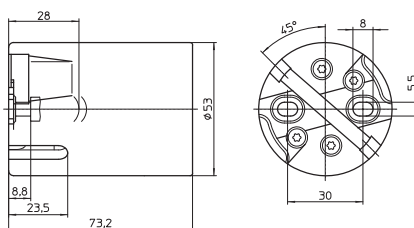

E40 lampholders

Only for lamps with base E40/E45

Casing: porcelain, white, T270

Fixing bracket with slots for screws M5

Weight: 217 g, unit: 50 pcs.

Type: 12910/12911

Ref. No.: 528253

Ref. No.: 528254 with lamp safety catch

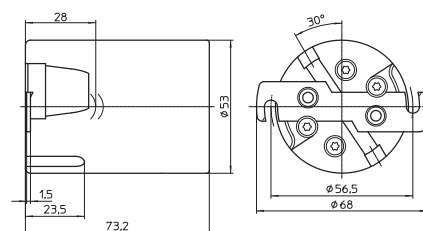

G8.5 Lampholders

For discharge lamps with base G8.5

Nominal rating: 2/500/5 kV
 Multipoint contacts: CuNiZn
 Fixing holes for screws M3

G8.5 lampholders

Push-in terminals for stranded conductors with ferrule bare end of cores \varnothing 1.4–1.8 mm
 Type: 33600 casing: LCP, black, T260
 Weight: 5 g, unit: 1000 pcs.

Ref. No.: 502394

Type: 33650 casing: ceramic, T300
 Weight: 12.6 g, unit: 150 pcs.

Ref. No.: 554542

G8.5 lampholder

Casing: ceramic, T300
 Welded leads: Cu tinned, stranded conductors 1 mm²,
 Si-insulation max. \varnothing 3.6 mm, length: 300 mm
 Weight: 26.4 g, unit: 100 pcs.

Type: 33671

Ref. No.: 554543

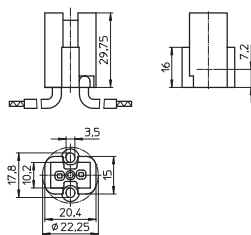
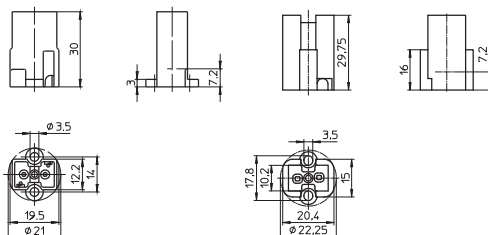

GU6.5 Lampholders

For discharge lamps with base GU6.5

Suitable for luminaries of protection class II
 Casing: ceramic, cover: PPS, T250
 Nominal rating: 2/250/5 kV
 Leads: Cu nickel-plated, stranded conductors 0.75 mm²,
 double PTFE-insulation, length: 250 mm

GU6.5 lampholders

Weight: 13.8 g, unit: 100 pcs.
 Type: 34510 fixing holes for screws M3

Ref. No.: 547761

Type: 34511 threaded bushes for screws M3

Ref. No.: 534220

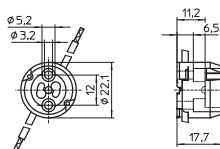
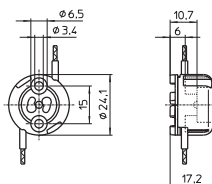

GU6.5 lampholder

Fixing holes for screws M3
 Identical mounting hole layout and lamp focus of the PGJ5 lampholder 34120 offer an effortless interchangeability of both lamp technologies.
 Weight: 15 g, unit: 100 pcs.

Type: 34520

Ref. No.: 539497

GX10 Lampholders

For discharge lamps with base GX10

GX10 lampholder, for luminaires of protection class II
 Casing: PPS, black, T240, nominal rating: 2/250/5 kV
 Push-in twin terminals for stranded conductors
 with ferrule bare end of cores max. \varnothing 1.8 mm
 Fixing holes for screws M3
 Weight: 9 g, unit: 100 pcs.. Type: 31400
Ref. No.: 509356

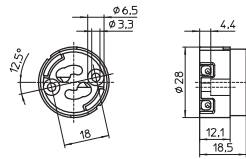

GX10 lampholder, for luminaires of protection class II
 Casing: steatite, cover plate: PPS
 T240, nominal rating: 2/500/5 kV
 Push-in terminals for stranded conductors
 with ferrule bare end of cores \varnothing 1.5–1.8 mm
 For leads with outer diameter: max. 3 mm
 Fixing holes for screws M3
 Weight: 14 g, unit: 100 pcs.
 Type: 31500
Ref. No.: 536469

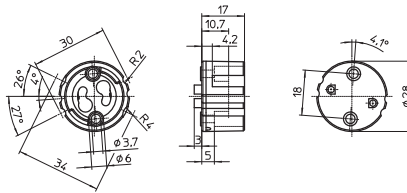

GX10 lampholder
 Casing: steatite, cover plate: PPS
 T240, nominal rating: 2/500/5 kV
 Welded leads: 2x0.75 mm², stranded conductors,
 length: 400 mm
 5 kV: Cu nickel-plated, PTFE-insulation,
 Cu tinned, Si-insulation
 Fixing holes for screws M3
 Weight: 36.3 g, unit: 100 pcs.
 Type: 31500
Ref. No.: 549999

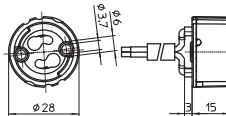

GX10 lampholder, for luminaires of protection class II
 Casing: steatite, cover plate: PPS
 T240, nominal rating: 2/500/5 kV
 Welded leads: Cu nickel-plated, stranded conductors
 0.75 mm², double PTFE-insulation, length: 250 mm
 Fixing holes for screws M3
 Weight: 23.3 g, unit: 100 pcs.
 Type: 31530
Ref. No.: 543267

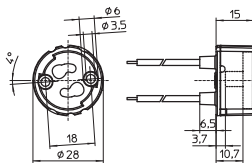

GY9.5 Lampholders

For discharge lamps with base GY9.5

GY9.5 lampholder

Casing: ceramic, cover plate: PPS, black

T240, nominal rating: 10/500/5 kV, contacts: Ni

Leads: Cu tinned, stranded conductors

5 kV: 1 mm², Si-insulation max. Ø 3.6 mm,

length: 300 mm and Cu tinned,

stranded conductors 0.75 mm², Si-insulation,

length: 300 mm

Fixing holes for screws M3

Weight: 48 g, unit: 150 pcs.

Type: 37001

Ref. No.: 533663

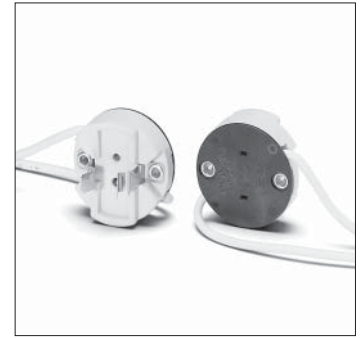
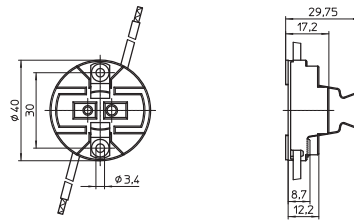

1

2

3

4

G12 Lampholders

For discharge lamps with base G12

G12 lampholders

Casing: ceramic, cover plate: LCP

T250, nominal rating: 5/500/5 kV

Contacts: CrNi

Push-in terminals for leads with

ferrule bare end of cores max. Ø 1.8 mm

Weight: 30.7 g, unit: 25 pcs.

Type: 42200/ 42210

Ref. No.: 535750 fixing holes Ø 4.2 mm

Ref. No.: 535751 threaded bushes M3

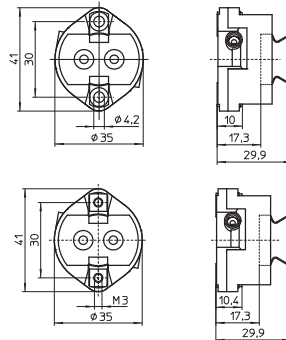

5

6

G12 lampholders

Casing: ceramic

T250, nominal rating: 5/500/5 kV

Contacts: CrNi

Welded leads: Cu tinned, stranded conductors 1 mm²

Si-insulation, white, length: 300 mm

Weight: 43/52 g, unit: 25 pcs.

Type: 42222/42242

Ref. No.: 535755 cover plate: LCP

Ref. No.: 543643 cover plate: ceramic

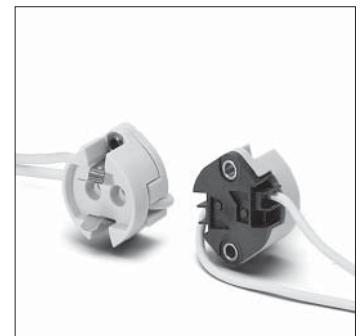
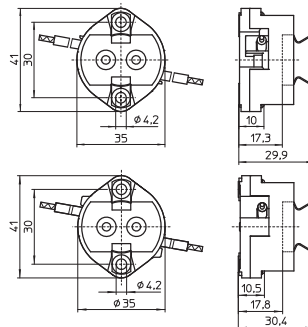

7

8

G12 lampholder

Casing: LCP, black

T250, nominal rating: 2/500/5 kV

Contacts: CrNi

Push-in terminals for leads with

ferrule bare end of cores max. Ø 1.8 mm

For tinned lead ends: 0.5–1 mm²

Fixing holes for screws M4

Weight: 13.6 g, unit: 250 pcs.

Type: 42000

Ref. No.: 509213

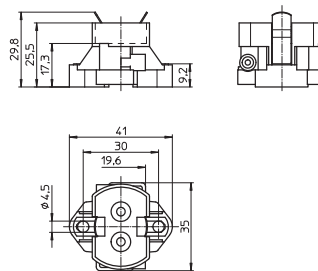

9

10

RX7s Lampholders

If the central hole on the bracket is used for fixing it has to be ensured by an additional support within the luminaire that the bracket cannot be deformed. If the lampholders are used for lamps with ignition voltage max. 20 kV the luminaire manufacturer is responsible for sufficient creepage distances and clearances.

RX7s lampholders

Contact pin: Ni, nominal rating: 2/500/5 kV
Lead: Cu tinned, stranded conductors 1 mm²,
Si-insulation max. Ø 3.6 mm, length: 300 mm
Fixing holes for screws M4
Weight: 23.3/20.1 g, unit: 25 pcs.
Type: 31662/31672 PPS, black, T220
Ref. No.: 107065 lead exit right
Ref. No.: 107066 lead exit left
Type: 31695/31696 LCP, black, T260
Ref. No.: 504416 lead exit right
Ref. No.: 504669 lead exit left

Remark on lampholders type 323 and 343:

The luminaire design must ensure protection from electric shock as well as sufficient creepage distances and clearances from live parts on the back of lampholder.

Type 343:

With doubled insulated leads suitable for luminaires of protection class II

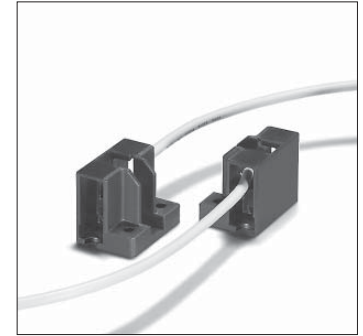
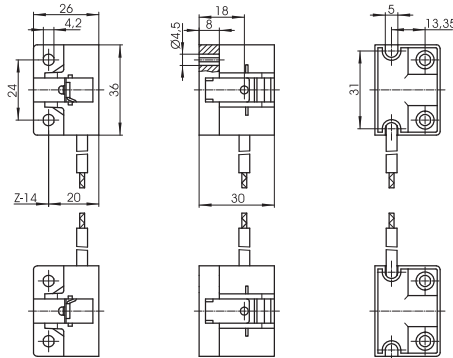

RX7s lampholder

Casing: PPS, black, T220
Contact pin: Cu, silver bulb
Nominal rating: 2/250/5 kV
Lead: Cu tinned, stranded conductors 1 mm²,
Si-insulation max. Ø 3.6 mm, length: 200 mm
With screw M4
Weight: 14 g, unit: 300 pcs.
Type: 34301
Ref. No.: 509117

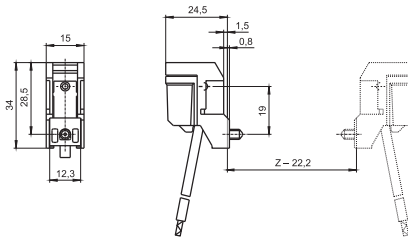

RX7s lampholder

Casing: PPS, black, T220
Contact pin: Cu, silver bulb
Nominal rating: 2/250/5 kV
Leads: Cu tinned, stranded conductors 1 mm²,
Si-insulation max. Ø 3.6 mm, length: 200 mm
Oblong holes for screws M4
Central hole for screw M4
Other bracket versions on request
Weight: 43.8 g, unit: 200 pcs.
Type: 34311 contact distance 114.2 mm
Ref. No.: 529841

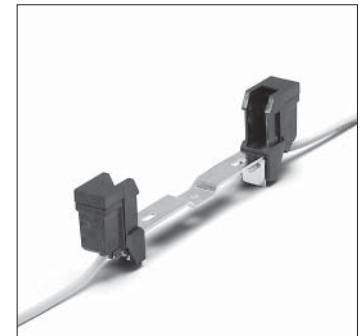
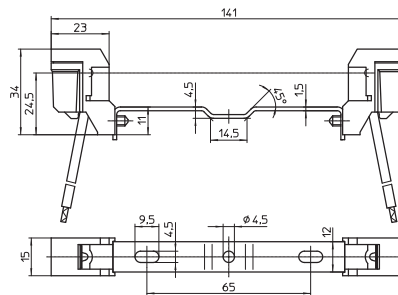

RX7s lampholder

Casing: PPS, black, T220
Contact pin: Cu, silver bulb
Nominal rating: 2/250/5 kV
Leads: Cu tinned, stranded conductors 1 mm²,
Si-insulation max. Ø 3.6 mm, length: 200 mm
Oblong holes for screws M4
Central tapped hole M4
Weight: 47.5 g, unit: 200 pcs.
Type: 34326 contact distance: 132 mm
Ref. No.: 529845

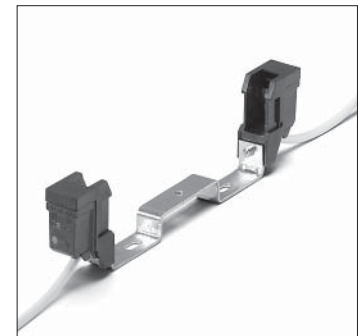
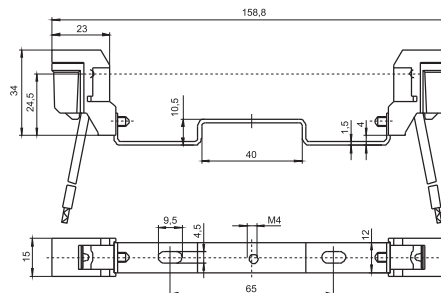

Lampholders for Discharge Lamps

Partly enclosed RX7s lampholder

Casing: ceramic, T350

Contact pin: Cu, silver bulb

Nominal rating: 4/500/5 kV

Leads: Cu tinned, stranded conductors 1 mm²,

Si-insulation max. Ø 3.6 mm, length: 200 mm

Oblong holes for screws M4

Central hole for screw M5

Weight: 76.4 g, unit: 200 pcs.

Type: 32381 contact distance: 114.2 mm

Ref. No.: 100937

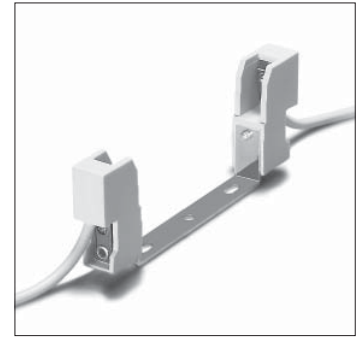
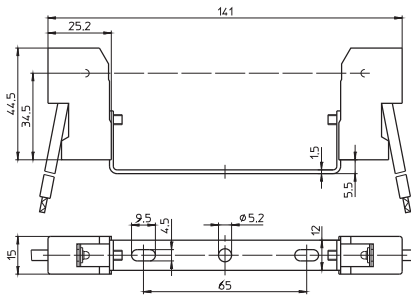

Partly enclosed RX7s lampholder

Casing: ceramic, T350

Contact pin: Cu, silver bulb

Nominal rating: 4/500/5 kV

Leads: Cu tinned, stranded conductors 1 mm²,

Si-insulation max. Ø 3.6 mm, length: 200 mm

Oblong holes for screws M4

Central tapped hole M4

Weight: 78.3 g, unit: 200 pcs.

Type: 32326 contact distance: 132 mm

Ref. No.: 100925

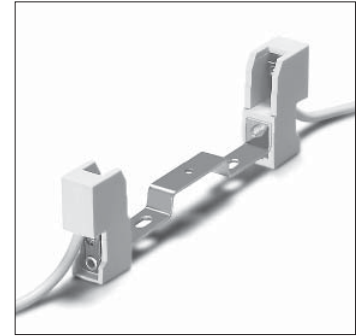
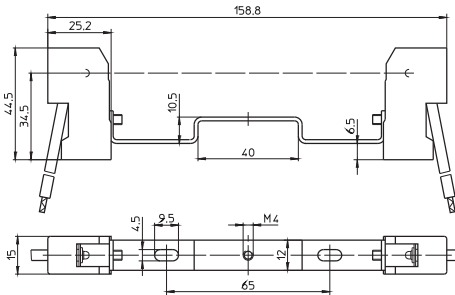

Partly enclosed RX7s lampholder

Casing: ceramic, T350

Contact pin: Cu, silver bulb

Nominal rating: 4/500/5 kV

Leads: Cu tinned, stranded conductors 1 mm²,

Si-insulation max. Ø 3.6 mm, length: 200 mm

Oblong holes for screws M4

Central hole for screw M5

Weight: 77.6 g, unit: 200 pcs.

Type: 32330 contact distance: 132 mm

Ref. No.: 100928

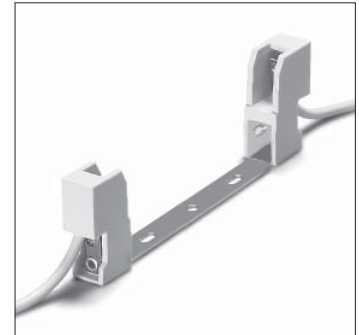
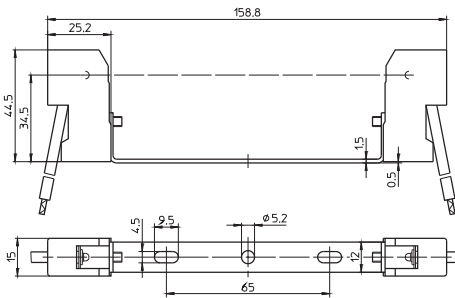

Partly enclosed RX7s lampholder

Casing: ceramic, T350

Contact pin: Cu, silver bulb

Nominal rating: 4/500/5 kV

Leads: Cu tinned, stranded conductors 1 mm²,

Si-insulation max. Ø 3.6 mm, length: 200 mm

Oblong holes for screws M4

Central hole for screw M5

Weight: 75.7 g, unit: 200 pcs.

Type: 32336 contact distance: 132 mm

Ref. No.: 100931

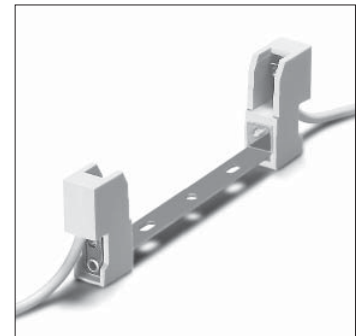
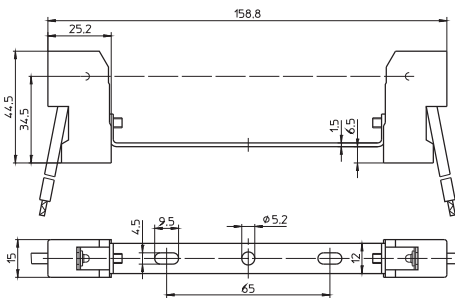

Protection caps for RX7s lampholders

For push-fit onto lampholders type 323

Protection against electrical shock

on the rear side of the lampholder

Lampholders with assembled protection cap

on request

Weight: 0.7/0.6 g, unit: 1000 pcs.

Type: 97528

Ref. No.: 507592 LCP, natural

Ref. No.: 507593 PET, white

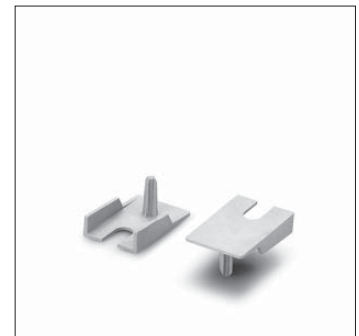
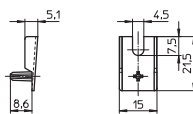

Lampholders for Discharge Lamps

RX7s lampholder

Casing: ceramic, T250

Contact pin: Ni

Nominal rating: 10/500/5 kV

Lead: Cu tinned, stranded conductors 1 mm²,
Si-insulation max. Ø 3.6 mm, length: 300 mm

Fixing holes for screws M4

Weight: 72 g, unit: 25 pcs.

Type: 30602

Ref. No.: 100723

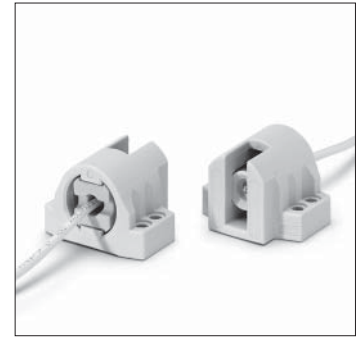
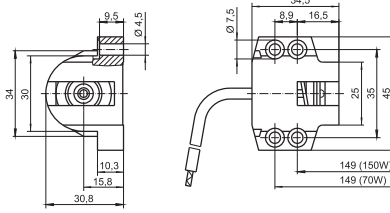

1

2

RX7s lampholder

Casing: ceramic, T250, contact pin: Ni

Nominal rating: 10/500/20 kV

Lead: Cu tinned, stranded conductors 1 mm²,
Si-insulation with spun glass filler Ø 7 mm,
for ignition voltage: max. 20 kV,
length: 1000 mm

Fixing holes for screws M4

Weight: 120 g, unit: 25 pcs.

Type: 30620

Ref. No.: 100741

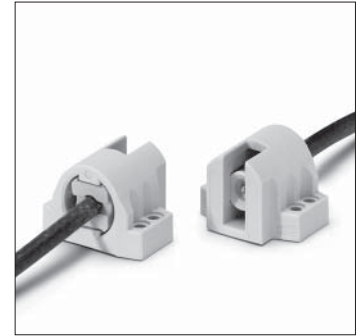
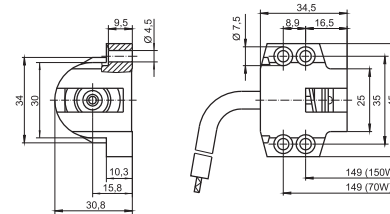

3

4

Fc2 Lampholders

For discharge lamps with base Fc2

If the lampholders are used for lamps with ignition voltage max. 20 kV the luminaire manufacturer is responsible for sufficient creepage distances and clearances.

Fc2 lampholder

Casing: ceramic, T250

Nominal rating: 10/500/5 kV

Contacts: Ni

Lead: Cu tinned, stranded conductors 1 mm²,
Si-insulation max. Ø 3.6 mm, length: 300 mm

Fixing holes for screws M4

Weight: 100 g, unit: 200 pcs.

Type: 02500

Ref. No.: 108937

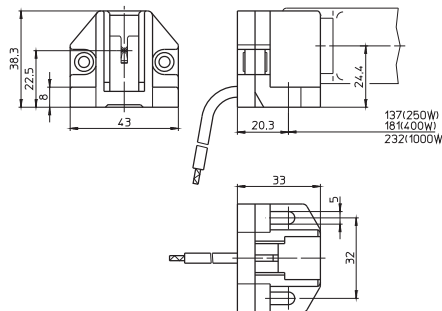

7

8

Fc2 lampholder

Casing: ceramic, T250

Nominal rating: 10/500/5 kV, contacts: Ni

Lead: Cu tinned, stranded conductors 1 mm²,
Si-insulation max. Ø 3.6 mm, length: 300 mm

Fixing screws M4, captive

Weight: 102 g, unit: 25 pcs.

Type: 02574 rigid fixing

Ref. No.: 100096

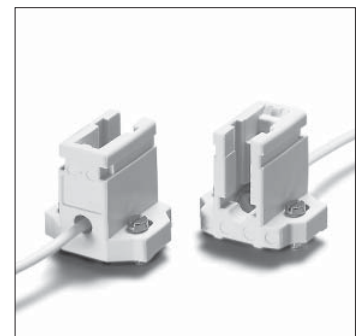
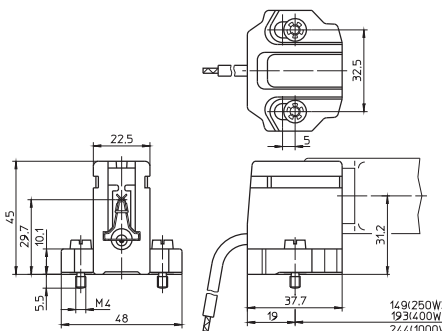

9

10

Lampholders for Discharge Lamps

Fc2 lampholder

Casing: ceramic, T250

Nominal rating: 10/500/5 kV, contacts: Ni

Lead: Cu tinned, stranded conductors 1 mm²,

Si-insulation max. Ø 3.6 mm, length: 300 mm

Fixing screws M4, captive

Weight: 102 g, unit: 25 pcs.

Type: 02575 adjustable fixing

Ref. No.: 100098

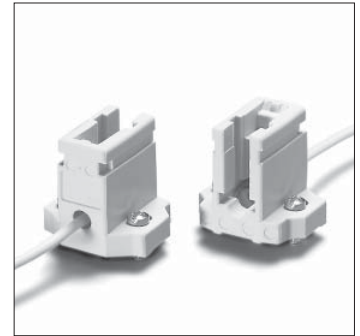
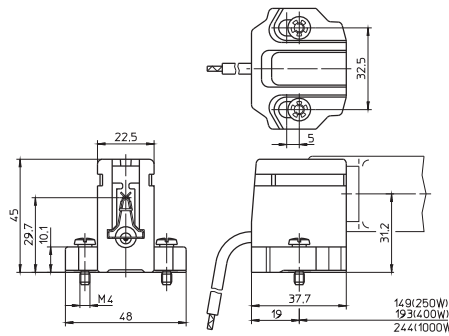

Fc2 lampholder

Casing: ceramic, T250

Nominal rating: 10/500/20 kV, contacts: Ni

Lead: Cu tinned, stranded conductors 1 mm²,

Si-insulation with spun glass filler Ø 7 mm,

for ignition voltage: max. 20 kV,

length: 500 mm

Fixing screws M4, captive

Weight: 120 g, unit: 25 pcs.

Type: 02525 rigid fixing

Ref. No.: 100082

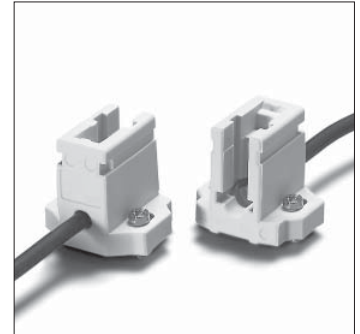
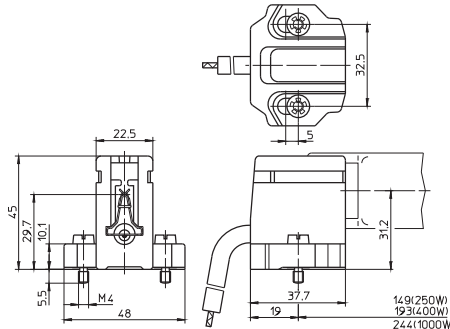

Fc2 lampholder

Casing: ceramic, T250

Nominal rating: 10/500/20 kV, contacts: Ni

Lead: Cu tinned, stranded conductors 1 mm²,

Si-insulation with spun glass filler Ø 7 mm,

for ignition voltage: max. 20 kV,

length: 500 mm

Fixing screws M4, captive

Weight: 120 g, unit: 25 pcs.

Type: 02543 adjustable fixing

Ref. No.: 100086

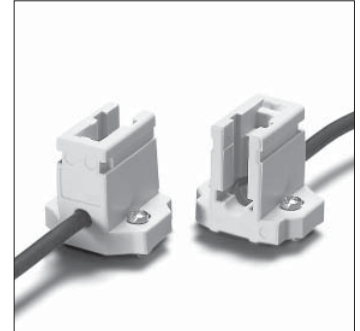
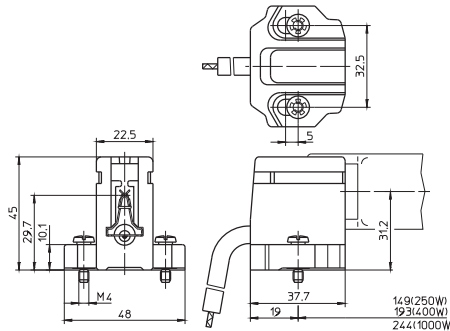

Lamp safety catch

For push-fit onto the lampholders 100082,

100086, 100096 and 100098

Casing: ceramic

Spring: stainless steel

Weight: 21 g, unit: 50 pcs.

Type: 86037

Ref. No.: 103818

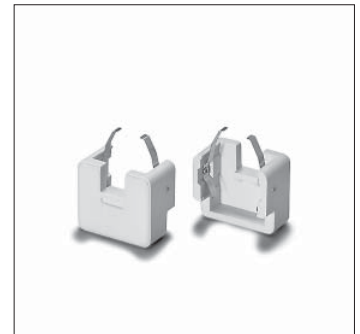
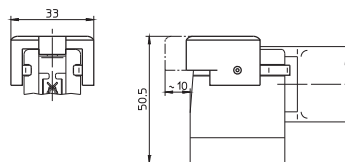

K12x30s Lampholders

For discharge lamps with base K12x30s

K12x30s lampholders

Suitable for luminaires of protection class II

Casing: LCP, black, T150

Nominal rating: 4/500/3 kV

Contacts: CuSn6, silver plated

Leads: Cu tinned, stranded conductors 1 mm²

Si-insulation, doubled insulated

Rear recess M4, wrench size 7

Rear and bottom fixing holes for screws M5

Weight: 75.9/61.5 g, unit: 100 pcs.

Type: 13010

Ref. No.: 532430 lead length: 705 mm

Ref. No.: 532431 lead length: 155 mm

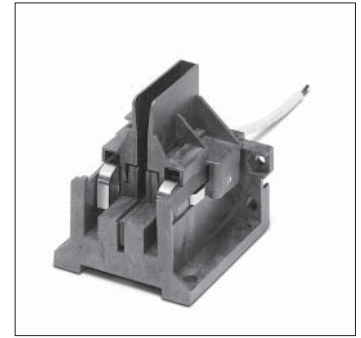
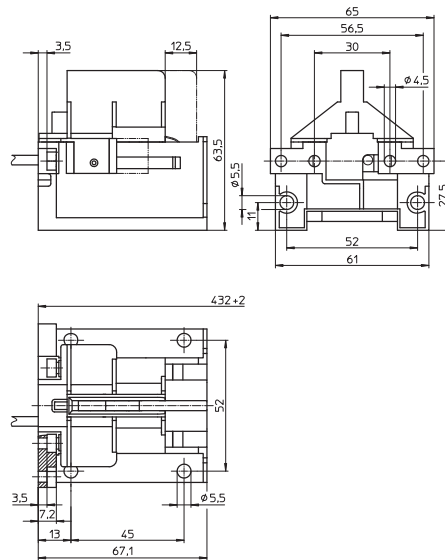

1

2

3

4

5

6

7

8

9

10

K12s-7 Support

For metal halide lamps 1000 and 2000 W

Type Osram HQI TS and Radium HRI TS

The luminaire design must ensure protection from electric shock as well as sufficient creepage and clearance distances.

K12s-7 support

Cable connection on cable lug for lead 0.75–2.5 mm²

Casing: ceramic, T300

Support: stainless steel, heat-resistant

Oblong holes for screws M5

Weight: 70 g, unit: 25 pcs.

Type: 21100

Ref. No.: 107677

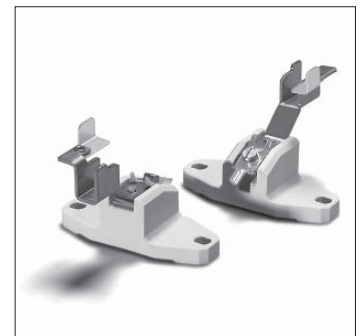
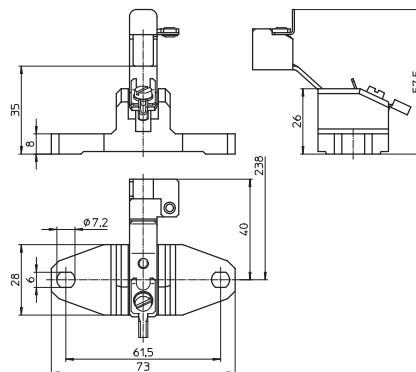

2

Components for Discharge Lamps

Electronic ballasts	79-84
Assembly instructions for mounting and installing	80-84
Circuit diagrams	84
Electromagnetic ballasts	84-89
Power reduction	84-85
Assembly instructions for mounting and installing	89-92
Electromagnetic control gear units	86-89
Assembly instructions for mounting and installing	86-89
Circuit diagrams – Electromagnetic ballasts	93-95
Lampholders for high-pressure discharge lamps	96-97
Ignitors	97-102
Assembly instructions for mounting and installing	100-102
Power switches	103-105
Switch units	105-106
Lamp table	107-119
Energy efficiency classification	118
General technical details	348-356
Glossary	357-359

If the electrical current through a discharge lamp is increased, a discharge channel with very high luminous efficiency is created in the discharge chamber. Luminous flux and light output increase substantially. The internal pressure of the discharge chamber rises and attains between 1 and 10 bar – these are so-called high-pressure discharge lamps or simply discharge lamps. The light output and colour rendition of high-pressure lamps vary considerably depending on the lamp family.

Discharge lamps can only be operated with ballasts. Igniters are additionally required for sodium lamps and metal halide lamps. Furthermore, to compensate blind current when using magnetic ballasts, compensation capacitors must be fitted. The lampholders enable the lamp to be fixed in the luminaire and ensure simple exchange of lamps at the end of their service life.

As well as stabilising the lamp's operating point, ballasts also influence the lamp's output and luminous flux, the system's light output, the service life of the lamps as well as the colour temperature of the light.

The following chapters provide technical information regarding VS components for

- High-pressure sodium lamps (HS lamps)
- Metal halide lamps (HI lamps)
- Metal halide lamps with a ceramic discharge tube (C-HI lamps)
- Mercury vapour lamps (HM lamps)
- Low-pressure sodium lamps (LS lamps)

Electromagnetic or electronic ballasts can be used for high-pressure discharge lamps. Unlike with fluorescent lamps, lamp efficiency is not decisively altered by the use of electronic ballasts. In contrast, electronic ballasts lead to a reduction of the inherent losses and thus to an increase in system efficiency. In addition, electronic ballasts ensure gentle lamp operation, which increases the lamp's service life.

Independent electronic and electromagnetic ballasts have also been developed, which in the form of control gear units then provide special advantages during application.

Electronic Ballasts for HI and C-HI Lamps

Electronic ballasts are fitted with all the components required to operate discharge lamps. Furthermore, they safely shut down lamps at the end of their service life to prevent high temperatures from being generated within the luminaires that could influence the service life of the luminaires and components.

By adding a strain-relief module, VS electronic built-in ballasts turn into independent operating devices that can, for instance, be used as a power unit and can also be installed in intermediate ceilings in this form.

1

2

3

4

5

6

7

8

9

10

Assembly Instructions for Electronic Ballasts

Assembly instructions for mounting and installing electronic ballasts for high-pressure discharge lamps

Mandatory regulations

DIN VDE 0100	Erection of low voltage installations
EN 60598-1	Luminaires – part 1: general requirements and tests
EN 61347-1	Operating devices for lamps – part 1: general and safety requirements
EN 61347-2-12	Control gear for lamps; part 2-12: Particular requirements for d.c. or a.c. supplied electronic ballasts for discharge lamps (excluding fluorescent lamps)
EN 55015	Limits and methods of measurement of radio disturbance characteristics of electrical lighting and similar equipment
EN 61000-3-2	Electromagnetic Compatibility (EMC) – part 3: maximum values – main section part 2: maximum values for mains harmonics (device input current up to and including 16 A per conductor)
EN 61547	Installations for general lighting purposes – EMC immunity requirements

Descriptions of VS EBs for discharge lamps

The type designations for VS HID ballasts all follow the same pattern, as follows:

EHXc	70	.326
Electronic ballast for HID lamps	Wattage	Serial number

Mechanical mounting

Surface	Firm, flat surface required to ensure good heat transfer. Avoid mounting on protruding surfaces.
Mounting location	Electronic ballasts must be protected against moisture and heat. Installation in outdoor luminaires: water protection rate of > 4 (e.g. IP54 required).
Fastening	Using M4 screws in the designated holes
Heat transfer	If the ballast is destined for installation in a luminaire, sufficient heat transfer must be ensured between the electronic ballast and the luminaire casing. Electronic ballasts should be mounted with the greatest possible clearance to heat sources or lamps. During operation, the temperature measure at the ballast's t_c point must not exceed the specified maximum value.

Supplement for independent electronic ballasts

Mounting position	Any position using the mounting tabs
Clearance	Min. of 0.10 m from walls, ceilings and insulation Min. of 0.10 m from further electronic ballasts Min. of 0.25 m from sources of heat (lamp)
Surface	Solid; EB must not be allowed to sink into insulation materials

Technical specifications

Type	Operating voltage range AC: 220 V...240 V	Protective conductor mA	Mean service life*** hrs.	Power factor λ	Temperature protection*	Possible no. of VS devices/automatic cutout type			
						B (10A)	B (16A)	C (10A)	C (16A)
Standard EB									
EHXc 35.325 (183033;183034)	$\pm 10\%$	≤ 0.5	32,000 (t_c 85 °C)	0.95	yes**	7	12	12	20
			40,000 (t_c 80 °C)						
			50,000 (t_c 75 °C)						
EHXc 35.325 (183035)	$\pm 10\%$	≤ 0.5	32,000 (t_c 80 °C)	0.95	yes	7	12	12	20
			40,000 (t_c 75 °C)						
			50,000 (t_c 70 °C)						
EHXc 35G.327	+6 –10%	≤ 0.5	30,000 (t_c 80 °C)	> 0.95	yes	7	12	12	20
EHXc 70.326 (183036)	$\pm 10\%$	≤ 0.5	32,000 (t_c 80 °C)	0.95	yes**	7	12	12	20
			40,000 (t_c 75 °C)						
			50,000 (t_c 70 °C)						
EHXc 70.326 (183038)	$\pm 10\%$	≤ 0.5	26,000 (t_c 75 °C)	0.95	yes	7	12	12	20
			40,000 (t_c 65 °C)						
			50,000 (t_c 60 °C)						
EHXc 150G.334	+6 –10%	≤ 0.5	50,000 (t_c 75 °C)	> 0.98	yes	4	7	7	12

* The devices are fitted with a temperature switch to protect against impermissible overheating.

Once the device has cooled down, it is switched on again. It may prove necessary to briefly dis- and then reconnect the device to the mains voltage.

** The temperature protection inside the luminaire must be checked when using devices without a cap.

*** To achieve the mean service life, the max. temperature ($t_{c,max}$) at the t_c point must not be exceeded; failure rate = 0.2% per 1000 hrs

Product features

Shutdown of defective lamps

In the event of a lamp failing to ignite or of a lamp with an increased operating voltage (end of the lamp's service life), the electronic ballast will switch off after a defined period of time (< 20 minutes). The ballast will also shut down if the lamp fails to attain its specified rated output. The ballast can be reset by disconnecting and then reconnecting the mains voltage. The ballast must always be disconnected from the mains prior to changing a lamp.

EOL Effect

In high-pressure discharge lamps, the EOL effect manifests itself in a change of the lamp's voltage. These changes can, for instance, occur due to unsealed parts of the burner or the rectifier effect. An automatic EOL cut-out prevents safety risks at the end of the service life of high-pressure discharge lamps. EOL tests are conducted to check the behaviour of electronic ballasts at the end of a lamp's service life. The EOL cut-out stops the lamp base overheating at the end of a lamp's service life.

Short-circuit resistance

The ballast outputs (to the lamp) are short-circuit-proof. Short-circuits between the lamp connection and the casing (earth conductor) will destroy the ballast.

Temperature protection

To prevent excess temperatures, some ballasts are fitted with temperature protection. A ballast will restart after it has cooled down. It might be necessary to briefly interrupt the supply voltage. The above table contains a list of temperature-protected devices.

Transient mains peak protection

Values are in compliance with EN 61547 (interference immunity).

Electrical installation

Wiring

- The wiring between the mains, electronic ballast and lamp must comply with the respective circuit diagram. Note: the luminaire casing (metal) must be connected to the earth conductor.
- The electronic ballast must be earthed using a toothed washer or similar (protection class I, compliance with RFI/BCI standards).
- To ensure compliance with RFI suppression limits, mains conductors should not be wired parallel to lamp conductors and maximum clearance should be ensured.
- After the installation of electronic ballasts, luminaires must be tested to ensure compliance with maximum values laid down in EN 55015.

It is permissible to connect the protective conductor of the ballast by attaching the ballast to metal conductors that are connected to the protective conductor. In doing so, care must be taken to ensure the protective conductor is contacted in accordance with EN 60598. If, however, a ballast is fitted with a connection terminal for a protective conductor without through-wiring and if this is to be used to connect the protective conductor, this connection terminal may only be used for the ballast itself.

Push-in terminals

The used terminals can be connected using rigid or flexible conductors with a section of 0.75–2.5 mm² (K35 ballasts: 0.5–1.5 mm²). The stripped conductor length is 10–11 mm (K35 ballasts: 8.5–9.5 mm) for terminal grid 3.5 mm. Conductors must not be tin-plated.

Error current

Impulse-resistant leak-current protection must be installed. Distribute the luminaires to phases L1, L2 and L3; install tri-phase FI switches. If permissible, install FI switches with 30 mA leak current; connect no more than 15 luminaires as FI switches can be triggered at half the leak current value.

Tri-phase connection of luminaires with EB

- Prior to operating newly installed lighting systems: check the mains voltage is appropriate to the electronic ballast's mains voltage range (AC, DC).
- The N-type conductor must be properly connected to all luminaires or ballasts.
- Conductors can only be connected or disconnected if the ballast is disconnected from the mains. Attention: N-type conductors must never be disconnected individually or as the first element.
- Insulation resistance test: from L to PE (L and N must not be connected)
- The neutral conductor must be reconnected after completion of the test.

Electromagnetic Compatibility (EMC)

Vossloh-Schwabe's electronic ballast range was developed in accordance with valid EMC standards (interference, interference immunity and mains harmonics) and specially designed to ensure safe compliance with the limiting values. It is assumed that any remarks regarding conductor wiring and conductor length in the instructions for installing electronic ballasts in luminaires or for independent ballasts will be observed.

Compensation

Luminaires with electronic ballasts do not need compensation (power factor ≥ 0.95).

Selection of automatic cut-outs

Dimensioning automatic cut-outs

High transient currents occur when an EB is switched on because the capacitors have to load. Lamp ignition occurs almost simultaneously. This also causes a simultaneous high demand for power. These high currents when the system is switched on put a strain on the automatic conductor cut-outs, which must be selected and dimensioned to suit.

Release reaction

The release reaction of the automatic conductor cut-outs comply with VDE 0641, part 11, for B, C characteristics.

No. of electronic ballasts (see table on page 81)

The maximum number of VS ballasts applies to cases where the devices are switched on simultaneously. Specifications apply to single-pole fuses. The number of permissible ballasts must be reduced by 20% for multi-pole fuses. The considered circuit impedance equals 400 mΩ (approx. 20 m [2.5 mm²] of conductor from the power supply to the distributor and a further 15 m to the luminaire). Doubling circuit impedance to 800 mΩ increases the possible number of ballasts by 10%.

Additional information

Information on the installation of electronic ballasts for optimising EMC. To ensure good radio interference suppression and the greatest possible operating safety, the following points should be observed when installing electronic ballasts:

- Conductors between the EB and the lamp (HF conductors) must be kept short (reduction of electromagnetic interference).
- Mains and lamp conductors must be kept separate and if possible should not be laid in parallel to one another. The distance between HF and mains conductors should be as large as possible, ideally > 5 cm. (This prevents the induction of interference between the mains and lamp conductors.)
- The mains conductor within the luminaire must be kept short (to reduce the induction of interference).
- Devices must be properly earthed. EBs require secure contacts to the luminaire casing or must be earthed using a PE connection. This PE connection should be effected using an independent conductor to achieve better dissipation of the leak current. EMC improves at frequencies greater than 30 MHz.
- The mains conductor must not be laid too close to the EB or the lamp (this is especially important in the event of through-wiring).
- Mains and lamp conductors must not be crossed. Should this be impossible to avoid, conductors should be crossed at right angles to one another if at all possible.
- Should conductors be wired through metal parts, such conductors must always be additionally shielded (e.g. with an insulating sleeve or grommet).

Temperature

Reference point temperature t_c

The safe operation of electronic ballasts is dependent on the maximum permissible temperature not being exceeded at the measuring point. Vossloh-Schwabe has determined a casing temperature measuring point – $t_{c \max}$ – on all EB casings. To avoid shortening the service life or diminishing operating safety, the stipulated maximum temperature must not be exceeded at this t_c point. This point is determined by testing the converter during normal, IEC-standardised operation at the specified ambient temperature (t_a), which is also indicated on the type plate. As both the design-related ambient temperature and the ballast's inherent heat, as determined by the installed load, are subject to great variation, the casing temperature should be tested at the t_c point under real installation conditions.

Ambient temperature t_a

The ambient temperature – as specified on every EB – denotes the permissible temperature range within the luminaire.

Reliability and service life

If the max. temperature at the t_c reference point (as specified on the type plate and the technical documentation of the ballast) is not exceeded, the defined service life can be expected to be achieved, assuming a switching cycle of 165 minutes on and 15 minutes off. See table on page 81 for service life details.

1

2

3

4

5

6

7

8

9

10

Circuit diagrams for metal halide lamps (HI) and high-pressure sodium lamps (HS) with electronic ballasts (EB)

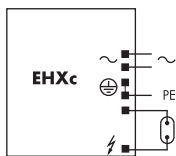

35G.327, 35.325,
70.326, 150G.334

Electromagnetic Ballasts for Discharge Lamps

Electromagnetic ballasts for HI and HS Lamps

As the lamp manufacturer's reference values regarding lamp current and voltage are generally identical for metal halide (HI) and high-pressure sodium lamps (HS) of the same lamp wattage and the impedance values required for the ballast are also identical, the same ballasts can frequently be used for both lamp types. It should be remembered that HI lamps react sensitively to impedance deviations from the rated value with appreciable colour changes. Vossloh-Schwabe ballasts therefore comply with the lamp's narrower tolerances. Moreover, ballasts remain below the maximum peak DC value for HI lamps. This value is not specified for HS lamps; instead, the maximum stated start-up current must not be exceeded.

In order to keep the temperature of the luminaires and the electrical values of the lamps within tolerable limits, the impedance of the ballasts must remain constant over the entire service life. A so-called service life test (test of thermal durability) provides proof of this requirement having been met.

HI and HS lamps constitute a special case in terms of thermal testing. In rare cases, a safety risk can occur at the end of the service life of lamps fitted with external bulbs. The safety risk is caused by the so-called lamp rectifier effect, which can lead to overheating of ballasts, ignitors, lampholders and conductors and can therefore destroy the luminaire. Against this background, the luminaire standard EN 60598-1 "luminaires; part 1: general requirements and tests" has been supplemented by tests concerning this safety risk. As a result, since 1 September 2002, it has been illegal to market luminaires that do not comply with the new regulations. This means luminaires need to be fitted with thermal protection that prevents a luminaire from overheating in the event of this malfunction.

In this respect, it is recommended to use VS ballasts with temperature switches that have already been tested using this circuit.

Electromagnetic ballasts for HM lamps

Even in the event of major mains fluctuations (92–106% of the rated voltage), the ballast must not fall short of the no-load voltage specified by the lamp manufacturer nor exceed a fixed short-circuit current. The start-up current must be high enough to ensure that at least 90% of the lamp's operating voltage is achieved within 15 minutes.

Test circuit for thermally protected ballasts

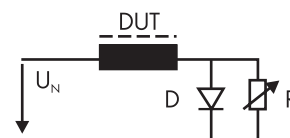

DUT Device under Test
D Diode, 100A, 600V
R Resistor, 0...200
(1/2 lamp output)
 U_N 110% of rated
supply voltage

Power reduction with HS and HM lamps

The lamp wattage can be reduced by operating the ballast at a higher impedance value, higher than the rated value. The lamp manufacturer's specifications must be observed in doing so to avoid shortening the lamp's service life. The lamps should be started at the ballast's rated impedance and only switched down to reduced operation after a period of at least five minutes.

The impedance value can be altered by using an additional ballast (high-effort option) or by using a switchable ballast (low-cost option). These ballast models can be switched using either a modern, time-controlled electronic power reduction switch, which is equipped with an additional control conductor (230 V), or a power reduction switch with a constant incentive rate setting (no control conductor).

The construction of power reduction switches with control conductors differs according to the selected increase in impedance.

Power reduction with switchable ballasts

Ballast type	Tested with	Mains voltage	System output 100% W	Reduced system output		Reduced luminous flux % (approx. values)
				W	%	
U-NaHJ 70/40%	HS 70	230, 50	83	50	60	55
U-NaH 100/40%	HS 100	230, 50	114	67	58	55
U-NaH 150/40%	HS 150	230, 50	160	98	61	55
U-NaH 250/40%	HS 250	230, 50	271	150	55	50
U-NaH 400/250.805	HS 400	230, 50	421	253	60	50
Q 80/50.596	HM 80	230, 50	90	55	61	55
Q 125/80.611	HM 125	230, 50	134	89	65	55
U-Q 250/150.438	HM 250	230, 50	274	164	60	55
U-Q 400/250.437	HM 400	230, 50	422	267	65	55

Example: Osram lamp, type NAV, HQL

Start-up switches

As high-pressure lamps operate with a start-up phase, the lamp's full luminous flux will only be reached after completion of this start-up period. In the event of disconnection from the mains, this start-up phase is dependent on the lamp's temperature. If an additional source of light is desired or required for this start-up period for safety-relevant applications, it is possible to switch on an auxiliary lamp with the help of a start-up switch.

There are two types of start-up switches:

- AS 1000 K for superimposed ignition systems. This switch monitors the lamp's operating voltage. If this is below a defined value (approx. 60% of the lamp's luminous flux), an auxiliary lamp is switched on.
- AS 1000 K A10 for pulse ignition systems and electronic ballasts.
This model switches the auxiliary lamp off after a defined period of time (10 minutes), after which the high-pressure lamp will have reached the desired illumination level.

Lamp family	Typical start-up time	Typical restart time (mains interruption at lamp operating temperature)
HS	3 min.	5 min.
HI / CHI	3 min.	10 min.
HM	4–5 min.	4–5 min.
LS	10 min.	5 min.

1

2

3

4

5

6

7

8

9

10

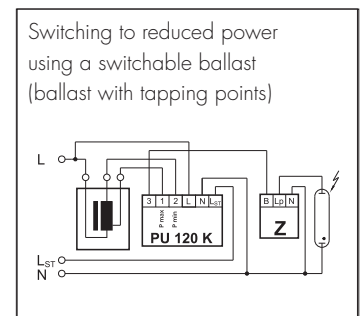
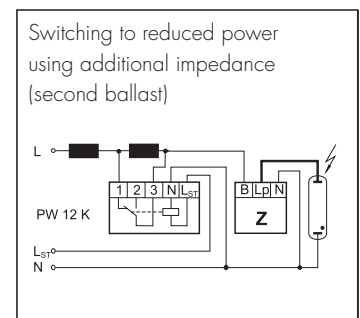

Control Gear Units for High-pressure Discharge Lamps

With electromagnetic ballasts

Control gear units with electromagnetic ballasts for high-pressure sodium lamps (HS), metal halide lamps (HI) and metal halide lamps with a ceramic discharge tube (C-HI) are fitted with all the components needed to ensure safe normal operation. Apart from a ballast, control gear units also contain a digital timer ignitor with IPP++ technology (Intelligent-Pulse-Pause-Mode), a compensation capacitor and a temperature switch with automatic reset. As all these components form a matched system, they create optimum operating conditions for lamps and small models. These compact control gear units remove the need for separate installation and wiring of individual components, thus considerably reducing assembly time.

Mandatory regulations

DIN VDE 0100	Erection of low voltage installations
EN 60598-1	Luminaires – part 1: general requirements and tests
EN 61347-1	Operating devices for lamps – part 1: general and safety requirements
EN 61347-2-1	Control gear for lamps; part 2-1: special requirements for ignitors (other than glow starters)
EN 61347-2-9	Control gear for lamps; part 2-9: special requirements for ballasts for discharge lamps (except fluorescent lamps)
EN 60923	Ballasts for discharge lamps – performance requirements
EN 60927	Operating devices for lamps; ignitors (glow starters); performance requirements
EN 61048	Operating devices for lamps – capacitors for fluorescent lamp circuits and other discharge lamp circuits; general and safety requirements
EN 61049	Operating devices for lamps – capacitors for fluorescent lamp circuits and other discharge lamp circuits; performance requirements
EN 55015	Limits and methods of measurement of radio disturbance characteristics of electrical lighting and similar equipment
EN 61000-3-2	Electromagnetic Compatibility (EMC) – part 3: maximum values – main section part 2: maximum values for mains harmonics (device input current up to and including 16 A per conductor)
EN 61547	Installations for general lighting purposes – EMC immunity requirements

Technical specifications

Operating voltage range

Control gear units can be operated at the specified mains voltage within a tolerance range of $\pm 10\%$ for HS/HI lamps and $\pm 3\%$ for C-HI lamps.

Leak current ≤ 0.1 mA

Compensation/power factor

Parallel-compensated control gear units with a power factor of $\lambda < 0.9$
($\lambda < 0.85$ for 100 W)

Degree of protection

IP40, IP65
IP54 for aluminium casing

Protection class

Independent, protection class II control gear units (plastic casing)
Independent, protection class I control gear units (aluminium casing)

Max. ambient temperature

See t_a value on the type plate of the control gear unit

Lead length to lamp

Max. 10 m

"F" designation

Suitable for mounting on surfaces of normal flammability

Mechanical mounting

Mounting position

Any position using the mounting tabs

Clearance

Min. of 0.20 m from walls, ceilings and insulation
Min. of 0.20 m from further control gear units
Min. of 0.25 m from sources of heat (lamp)

Surface

Solid; control gear unit must not be allowed to sink into insulation materials

Electromagnetic compatibility (EMC)

Interference

Interference voltage measurements only have to be taken at the connection terminals for luminaires with electromagnetic control gear units as these systems operate with lamp voltages of under 100 Hz. These low-frequency interference voltages are generally not critical with high-pressure discharge lamps with electromagnetic control gear units.

Interference immunity

Thanks to the robust design and choice of materials, electromagnetic control gear units provide a high degree of interference immunity and are not impaired by normal mains power interference.

Mains Harmonics

After every zero crossing of the lamp current, discharge lamps experience a re-ignition peak as the lamps go out for a brief (imperceptible) moment. These re-ignition peaks of discharge lamps generate mains harmonics that are smoothed by the ballast's impedance. VS electromagnetic control gear units all comply with the stipulated maximum values.

1

2

3

4

5

6

7

8

9

10

Selection of automatic cut-outs for VS control gear units

Dimensioning automatic cut-outs

When a control gear unit is switched on, high transient current peaks occur due to the smoothing capacitor having to load. The lamps are ignited almost simultaneously, which also causes energy consumption peaks. These high system switch-on currents put a strain on the automatic conductor cut-outs, which must be selected and dimensioned to suit.

Release reaction The release reaction of the automatic conductor cut-outs comply with VDE 0641, part 11, for B and C characteristics.

No. of control gear units

The following values are meant as guidelines only and may vary depending on the respective lighting system. The specified maximum number applies to the number of devices that can be switched on simultaneously. Specifications apply to single-pole fuses; using multi-pole fuses reduces the maximum number by 20%. The considered circuit impedance equals 400 mΩ (approx. 20 m [2.5 mm²] of conductor from the power supply to the distributor and a further 15 m to the luminaire). Doubling circuit impedance to 800 mΩ increases the possible number of control gear units by 10%.

Type of control gear unit	Type of automatic cut-out			
	B (10 A)	B (16 A)	C (10 A)	C (16 A)
VNaHJ 35PZT	7	12	12	20
VNaHJ 70PZT	7	12	12	20
VNaHJ 100PZT	6	10	10	16
VNaHJ 150PZT	5	8	8	14
VNaHJ 250PZT	3	5	5	7
VNaHJ 400PZT	2	4	3	5

Safety functions

Shutdown of defective lamps

In the event of a lamp failing to ignite the control gear unit will automatically shut down after a preset safety period. The programmed switch off time prevents flickering at the end of the lamp's service life. The control gear unit can be reset after shut down and lamp changing by disconnecting and then reconnecting the mains voltage.

Temperature protection

To protect against impermissible excess temperatures, the devices are fitted with a temperature fuse.

Protection against installation and wiring errors

The integrated IPP++ function will prevent the power unit from making any attempt to start the lamp in the event of an installation or wiring error and also if the neutral conductor is dislodged within the existing mains voltage network (three-phase supply network).

Should the nominal supply voltage be connected, the power unit will begin starting the lamp immediately.

Reliability and service life

The control gear units can be expected to provide a service life of 50,000 operating hours provided that the assembly instructions are observed and the maximum tw value of the ballast is not exceeded. Failure rate: < 0.1%/1,000 hrs

Electrical installation

Connection terminals

Terminals can be contacted with rigid or flexible conductors

- Rigid conductors: max. 2.5 mm²
- Flexible conductors: max. 2.5 mm²
- Stripped lead length: 10–11 mm
- Conductors must not be tin-plated

Connection leads

Admissible diameter 7–9 mm

The suitability of luminaire conductors and cables for use within luminaires with ignition devices must be checked in accordance with luminaire standard EN 60598-1 10.2.2.

In general, all silicone and standard PVC cables meet these requirements.

Wiring

The wiring between the supply mains, control gear unit and lamp must be in accordance with the circuit diagram shown on the type plate.

Note: luminaire casing (metal) must be connected to the protective earth conductor.

Assembly Instructions for Electromagnetic Ballasts

For mounting and installing electromagnetic ballasts for high-pressure discharge lamps

Mandatory regulations

DIN VDE 0100 Erection of low voltage installations

EN 60598-1 Luminaires – part 1: general requirements and tests

EN 61347-1 Operating devices for lamps – part 1: general and safety requirements

EN 61347-2-9 Operating devices for lamps; part 2-9: special requirements for ballasts for discharge lamps (except fluorescent lamps)

EN 60923 Ballasts for discharge lamps – performance requirements

EN 55015 Maximum values and methods of measurement for RFI suppression in electrical lighting installations and similar electrical appliances

EN 61000-3-2 Electromagnetic Compatibility (EMC) – part 3: maximum values – main section part 2: maximum values for mains harmonics (device input current up to and including 16 A per conductor)

EN 61547 Installations for general lighting purposes – EMC immunity requirements

1

2

3

4

5

6

7

8

9

10

Technical specifications

Operating voltage range

The ballasts can be operated at the specified mains voltage within a tolerance range of $\pm 10\%$ for HS/Hi and HM lamps and $\pm 3\%$ for C-HI lamps.

Leak current ≤ 0.1 mA

Compensation/power factor

Inductive ballasts: $\lambda \leq 0.5$

Parallel-compensated ballasts: $\lambda \geq 0.85$

Mechanical mounting

Mounting position

Any

Mounting location

Ballasts are designed for installation in luminaires or comparable devices. Independent ballasts do not need to be installed in a casing.

Fastening

Preferably using M4 to M6 screws, depending on the size of the ballast. Encapsulated ballasts may only be used with flat-headed screws (M5), underlaid with a washer (DIN 9021). (Tightening torque ≈ 2 Nm)

Temperature

The winding temperature t_w must be checked during operation and must not exceed the specified maximum value. It must be tested by using the standardised method of measuring resistance. The Δt marking on the type plate is a measure of the ballast's inherent heating and thus of its power loss. The lower this value is the lower the power loss of the ballast. This value is determined using standardised measuring regulations and constitutes a benchmark for comparing ballasts of the same design for selection purposes.

Electromagnetic compatibility (EMC)

Interference

Interference voltage measurements have to be taken at the connection terminals for luminaires with electromagnetic ballasts as these are systems that operate with lamp voltages of under 100 Hz. These low-frequency interference voltages are generally not critical with high-pressure discharge lamps with electromagnetic ballasts.

Interference immunity

Thanks to the robust design and choice of materials, electromagnetic ballasts provide a high degree of interference immunity and are not impaired by normal mains power interference.

Mains Harmonics

After every zero crossing of the lamp current, discharge lamps experience a re-ignition peak as the lamps go out for a brief (imperceptible) moment. These re-ignition peaks of discharge lamps generate mains harmonics that are smoothed by the ballast's impedance. VS electromagnetic ballasts all comply with the stipulated maximum values.

Selection of automatic cut-outs for VS electromagnetic ballasts

Dimensioning automatic cut-outs

When a ballast is switched on, high transient current peaks occur due to parasitic capacitances that can accumulate with the number of luminaires. These high system switch-on currents put a strain on the automatic conductor cut-outs. For this reason, only surge-current-proof automatic cut-outs should be used for lighting systems.

Technical Details – Components for Discharge Lamps

Release reaction The release reaction of the automatic conductor cut-outs comply with VDE 0641, part 11, for B and C characteristics.

No. of ballasts The following values are meant as guidelines only and may vary depending on the respective lighting system. The maximum number of VS ballasts applies to cases where the devices are switched on simultaneously. Specifications apply to single-pole fuses. The number of permissible ballasts must be reduced by 20% for multi-pole fuses. The considered circuit impedance equals 400 mΩ (approx. 20 m of [2.5 m²] conductor from the power supply to the distributor and a further 15 m to the luminaire). Doubling circuit impedance to 800 mΩ increases the possible number of ballasts by 10%. The values quoted in the following tables are guidelines and can be affected by system-specific factors.

Possible number of ballasts connected to automatic cut-outs with or without compensation

Lamp data		Cp μF	Max. number of ballasts connected to automatic cut-outs – without compensation / with compensation																			
W	V		C10		C13		C16		C20		C25		B10		B13		B16		B20		B25	
			without	with	without	with	without	with	without	with	without	with	without	with	without	with	without	with	without	with	without	with
Mercury vapour lamps (HM)																						
50	230	7	10	19	13	25	15	31	18	39	23	49	8	10	11	12	13	15	16	18	20	23
80	230	8	6	12	7	15	9	19	11	24	14	30	6	6	8	7	10	9	12	11	15	14
125	230	10	4	7	5	9	7	12	7	15	9	19	4	4	5	5	7	6	9	7	10	9
250	230	18	2	4	3	5	3	6	3	7	4	9	2	2	3	2	3	3	4	3	5	4
400	230	25	1	2	1	3	2	4	2	5	2	6	1	1	1	1	2	22	3	2	3	2
700	230	40	–	1	–	1	1	2	1	2	1	3	1	–	1	–	1	1	1	1	2	1
1000	230	60	–	1	–	1	–	1	1	2	1	2	–	–	–	–	1	–	1	1	1	1
Metal halide lamps (HI)																						
35	230	6	11	22	14	29	18	36	23	45	29	50	9	11	12	14	15	18	18	23	23	27
70	230	12	7	12	9	15	11	18	14	23	17	29	5	8	6	10	8	13	9	16	12	20
100	230	12	6	10	7	13	9	16	11	20	14	25	4	7	5	9	6	11	8	14	10	17
150	230	20	4	7	5	9	6	11	7	14	9	17	2	5	3	6	4	8	5	10	6	12
250	230	32	2	5	2	6	3	7	4	9	5	11	1	3	1	4	2	5	3	6	4	8
400	230	35	2	3	2	4	3	5	4	7	5	8	1	2	1	3	2	4	2	5	3	6
1000	230	85	–	1	–	1	1	1	1	3	1	3	–	–	–	–	–	1	1	1	1	2
2000	380	60	–	1	–	1	–	2	–	2	–	3	–	–	–	–	–	1	–	1	–	2
2000	380	37	–	–	–	–	–	1	–	1	–	2	–	–	–	–	–	–	–	1	–	1
3500	380	100	–	–	–	–	–	–	–	–	–	–	–	–	–	–	–	–	–	–	–	–
High pressure sodium vapour lamps (HS)																						
35	230	6	11	22	14	29	18	36	23	45	29	50	9	11	12	14	15	18	18	23	23	27
50	230	10	9	16	11	20	14	24	18	31	22	38	6	11	8	14	10	17	13	22	16	27
70	230	12	7	12	9	15	11	18	14	23	17	29	5	8	6	10	8	13	10	16	12	20
100	230	12	6	10	7	13	9	16	11	20	14	25	4	7	5	9	6	11	8	14	10	17
150	230	20	4	7	5	9	6	11	7	14	9	17	2	5	3	6	4	8	5	10	7	12
250	230	36	2	5	2	6	3	7	4	9	5	11	1	3	1	4	2	5	3	6	4	8
400	230	45	1	3	1	3	2	4	3	5	4	7	1	2	1	2	1	3	2	4	2	5
600	230	60	1	2	1	2	1	2	2	3	2	4	–	1	–	1	1	2	2	2	2	3
1000	230	100	1	1	1	1	1	1	1	2	2	3	–	–	–	–	–	1	1	1	1	2

Safety functions

The VS range includes ballasts with an integrated temperature switch that safely disconnects the lamp from the power supply if the lamp should develop the rectifier effect towards the end of its service life. The cut-out behaviour of the temperature switch is influenced by the luminaire construction. The luminaire manufacturer is responsible for checking the factory settings of the temperature switch in accordance with EN 60598-1 Section 12.5. VS can adjust the temperature switch to the appropriate cut-out temperature to suit requirements.

Reliability and service life

Provided the maximum winding temperature is not exceeded, the ballasts can be expected to yield a service life of 100,000 operating hours.

Failure rate < 0.025 %/1,000 hrs

Electrical installation

Push-in terminals Terminals can be contacted with rigid conductors up to a maximum of 1.5 mm².

- Screw terminals
- Terminals can be contacted with rigid or flexible conductors with ferrules on bare end of core
 - Conductor cross-sections are determined by the terminals and can vary according to type 0.5–1.5 mm² / 0.75–2.5 mm² / 1.5–2.5 mm²
 - Stripped lead length: 8–9 mm
 - Conductors must not be tin-plated
 - Max. tightening torque 0.5 Nm

Wiring The wiring between the power supply, ballast and lamp must be in accordance with the respective circuit diagram (see pages 93–95).

Components High-pressure discharge lamps must only be fitted with components that are rated to withstand the respective ignition voltage.

Circuit diagrams for high-pressure sodium lamps (HS) and metal halide lamps (HI)

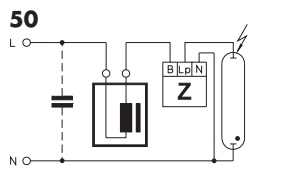

50 Superimposed ignition of HS and HI lamps

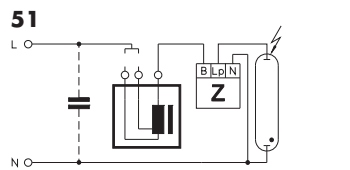

51 Superimposed ignition of HS and HI lamps (ballasts with two alternative voltage tapping points)

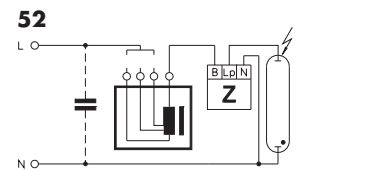

52 Superimposed ignition of HS and HI lamps (ballasts with three alternative voltage tapping points)

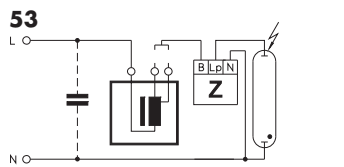

53 Superimposed ignition of HS and HI lamps (ballasts with two alternative power tapping points)

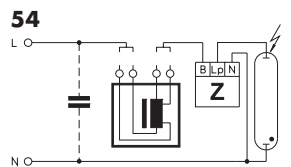

54 Superimposed ignition of HS and HI lamps (ballasts with two alternative voltage and power tapping points)

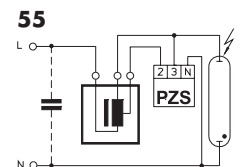

55 Pulse ignition of standard HS lamps

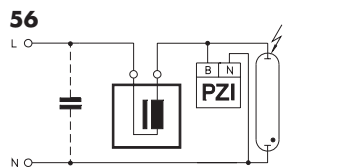

56 Pulse ignition of HI lamps, ignition voltage 0.9 kV

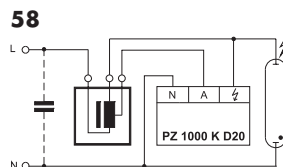

58 Pulse ignition for HS and HI lamps

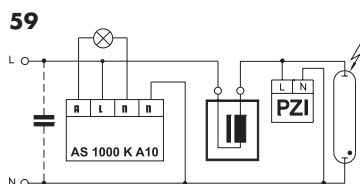

59 Start-up switch for HI lamps, ignition voltage 0.9 kV

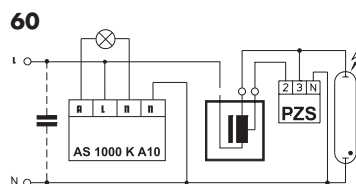

60 Start-up switch for standard HS lamps

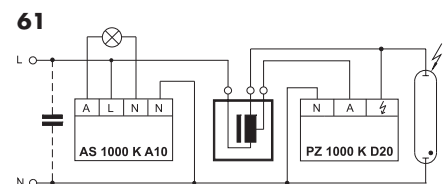

61 Start-up switch for HS and HI lamp

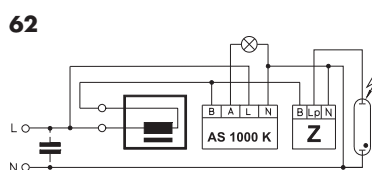

62 Start-up switch for HS and HI lamps

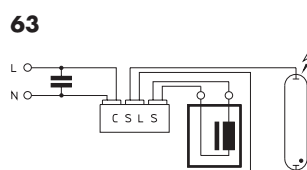

63 SDW-T lamps

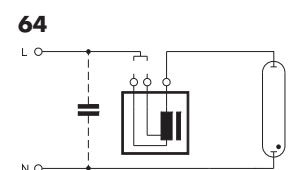

64 HS lamps with internal ignitor (ballasts with two alternative voltage tapping points)

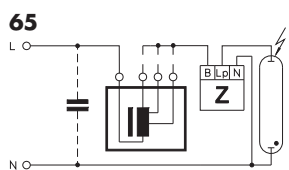

65 Superimposed ignition of HS and HI lamps with three alternative power tapping points

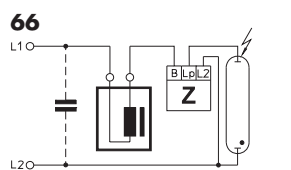

66 Superimposed ignition of HS and HI lamps with polyphase power systems

1

2

3

4

5

6

7

8

9

10

Circuit diagrams for mercury vapour lamps (HM)

67

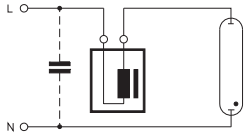

HM lamps

68

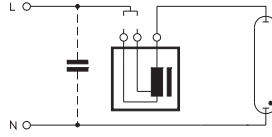

HM lamps (ballasts with two alternative voltage tapping points)

69

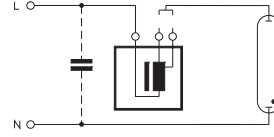

HM lamps (ballasts with two alternative power tapping points)

70

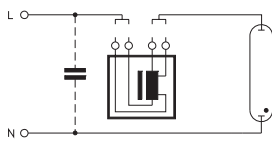

HM lamps (ballasts with two alternative voltage and power tapping points)

71

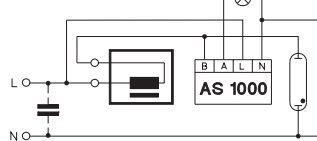

Start-up switch for HM lamps with auxiliary lamp

Power reduction of mercury vapour lamps (HM lamps)

L_{ST} connectable to L₁, L₂ and L₃

92

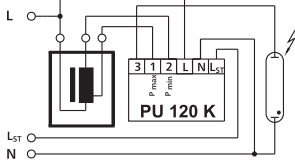

Disconnected control phase (L_{ST} = 0 V) with ballasts with two tapping points

93

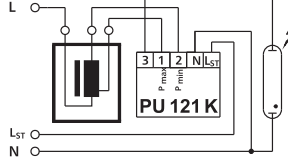

Connected control phase (L_{ST} = 230 V) with ballasts with two tapping points

94

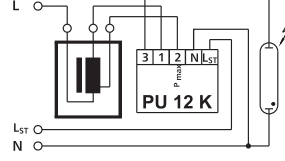

Disconnected control phase (L_{ST} = 0 V) with ballasts with two tapping points

95

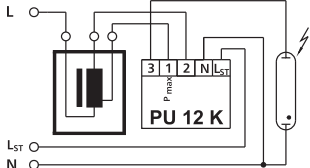

Connected control phase (L_{ST} = 230 V) with ballasts with two tapping points

96

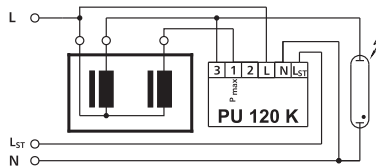

Disconnected control phase (L_{ST} = 0 V) with two ballasts connected in parallel

97

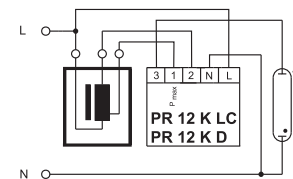

Electronic power reduction without control phase

98

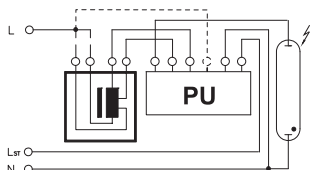

Ballasts with two tapping points and two voltage tapping points (L_{ST} = 0 V or L_{ST} > 0 V)

Power reduction of high-pressure sodium lamps (HS lamps) – superimposed ignition system

L_{ST} connectable to L1, L2 or L3

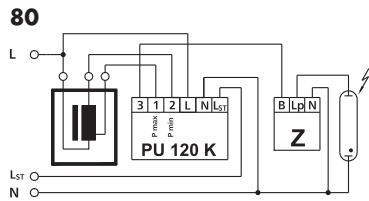

Disconnected control phase (L_{ST} = 0 V) with ballasts with two tapping points

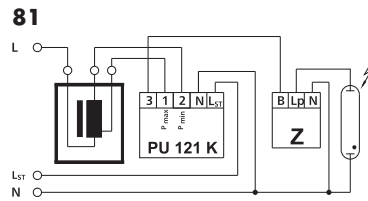

Connected control phase (L_{ST} = 230 V) with ballasts with two tapping points

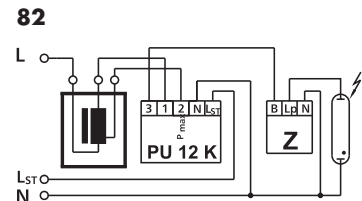

Disconnected control phase (L_{ST} = 0 V) with ballasts with two tapping points

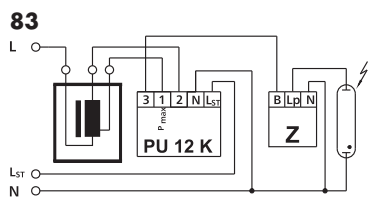

Connected control phase (L_{ST} = 230 V) with ballasts with two tapping points

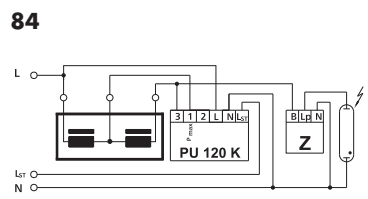

Disconnected control phase (L_{ST} = 0 V) with main ballast and additional inductance

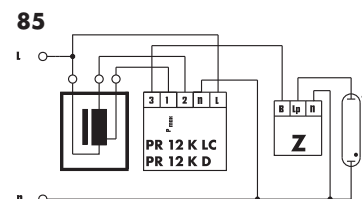

Electronic power reduction without control phase

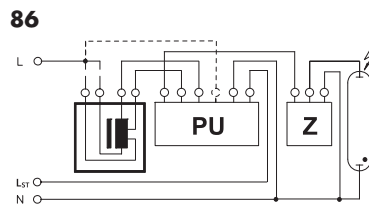

Ballast with two tapping points and two voltage tapping points (L_{ST} = 0 V or L_{ST} > 0 V)

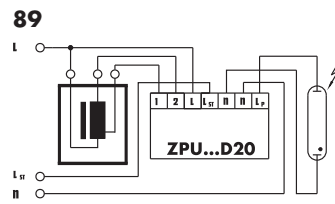

Disconnected control phase (L_{ST} = 0 V) with ballasts with two tapping points

Power switching of LED drivers and electronic ballasts

100

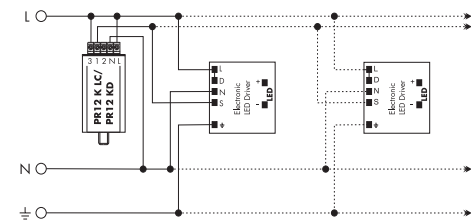

Lampholders for High-pressure Discharge Lamps

Metal halide and high-pressure sodium lamps feature extremely different bases, which include RX7s, Fc2, G8.5, GX8.5, GU8.5, GX10, G12, GX12, PG12, PGJ5, GU6.5, E27 and E40, depending on whether the lamp is single- or double-ended. All lampholders are subject to the same typical conditions found with discharge lamps: high ignition voltages and temperatures. The high start-up currents deserve particular attention in lampholder design. This is also reflected by the insulation materials, which are usually solid ceramics or heat-resistant plastic (e.g. PPS – polyphenylene sulphide). Depending on the lamp's requirements (voltage, current, temperature, etc.), silver, nickel and copper alloys with thick nickel coatings are used as conductors. The luminaire regulation EN 60598-1 (VDE 0711 part 1), defines the safety requirements with regard to ignition voltages in connection with creepage and air clearance distances. Special care must be taken to ensure that lampholders are approved for discharge lamps when using high-pressure lamps with E27 and E40 Edison bases. Lampholders that are suitable for this purpose are marked with a maximum value of "5 kV" and comply with the increased creepage and air clearance distances specified by the lampholder requirements in EN 60238 (VDE 0616 part 1). The lampholder regulations governing special lampholders, EN 60838-1 (VDE 0616 part 5), apply analogously to all other base systems. The high ignition voltage pulses also place special demands on the conductors. In practice, silicone-insulated conductors with an outer diameter of 3.6 mm have proved to be suitable for discharge lamps. Silicone-insulated conductors with a glass-silk lining with a diameter of 7 mm should be used for lamps with an instant hot restart (20 kV) function.

When connecting lampholders to push-in terminals of ballasts, the diameter of the conductor and the length of the stripped cables must be taken into account to ensure correct operation of the installed components. To this end, Vossloh-Schwabe can make additional versions available with compacted cable ends as further options.

When using compacted cable ends, the reduction of the cable diameter at the end of the cable must be taken into account, which means that the respective ballast push-in terminal has to be capable of taking the next-smaller cable diameter (see table with examples).

When using screw terminals to connect a ballast, it is recommended to use a ferrules on the bare end of core.

VS lampholders for the UL market and UL approved leads are available for all common lamp types.

Further information can be found at www.unvlt.com.

Ferrule on bare end of core

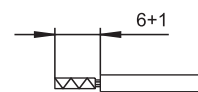

Compacted cable ends

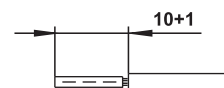

Cable cross-section mm ²	Push-in terminal range on the ballast when using compacted cable ends mm ²
0.75	≥ 0.5
1	≥ 0.75

Bases for the most commonly used HI and HS lamps

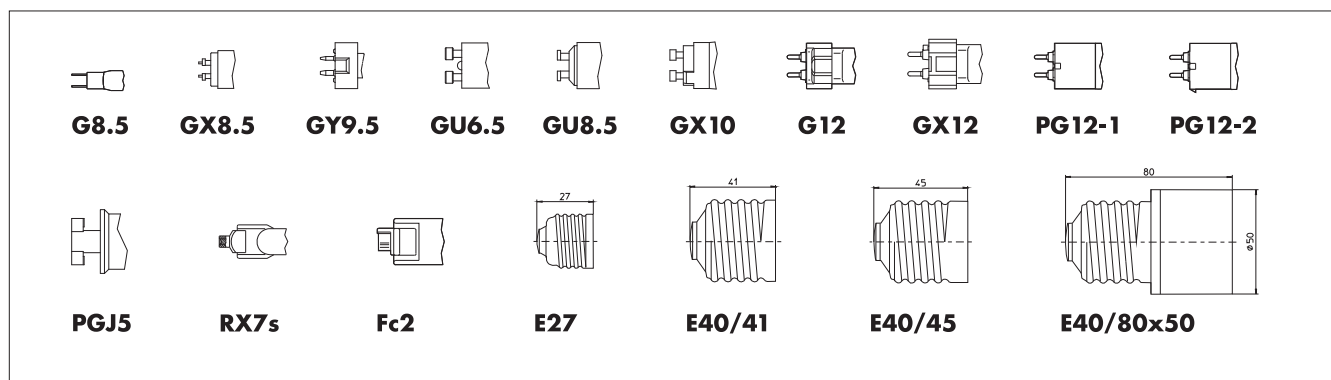

Bases for the most commonly used HM lamps

Edison bases are predominantly used for mercury vapour lamps (HM)

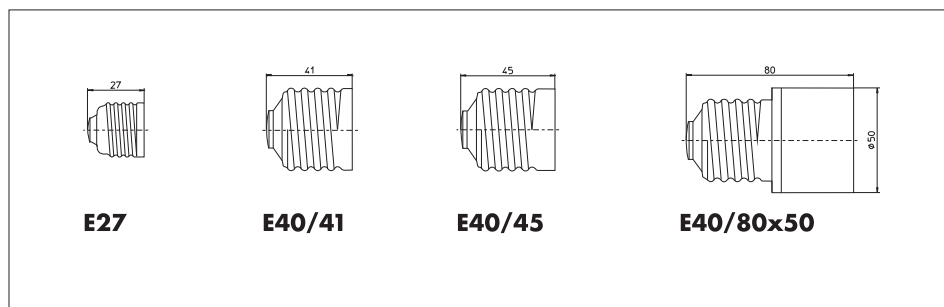

Ignitors

Ignition voltages for high-pressure sodium lamps (HS) and metal halide lamps (HI)

The ignition voltage of HS and HI lamps is determined by the respective lamp technology as well as the creepage and air clearance distances of the base-lampholder system. High-pressure sodium lamps of 35, 50 and 70 W with an E27 base are ignited with a voltage of between 1.8 and 2.3 kV. All other high-pressure lamps of the sodium and metal halide families require an ignition voltage of between 4 and 5 kV (except for special lamps and lamps with base PGJ5).

Superimposed ignitors

Superimposed ignitors work independently of ballasts and generate defined ignition pulses within the voltage ranges of 220–240 V $\pm 10\%$ and 380–415 V $\pm 10\%$. As the mains frequency only plays a minor role, these systems work equally well at 50 Hz and 60 Hz. In accordance with the lamp manufacturer's specifications, pulses or clusters of pulses of defined width and height are generated in every half wave. Although lamp current flows through superimposed ignitors, they only cause low losses in relation to the system's power consumption. The maximum ambient temperature can be calculated by subtracting the ignitor's self-heating, which is caused by the inherent losses, from the specified maximum casing temperature (t_c).

Superimposed ignitors should be mounted near the lampholder. The clearance needed between the ignitor and the lamp is determined by the respective maximum load capacitance, which is specified for each ignitor in the technical specifications. The capacitive load of the cable is dependent on its physical properties and wiring layout; this value usually ranges between 70 pF and 100 pF per metre. The casing temperature must not fall below $-30\text{ }^\circ\text{C}$ and must not exceed the maximum value specified on the device.

Pulse ignitors

Pulse ignitors use the winding of an inductive ballast to generate the pulse voltage needed to ignite high-pressure discharge lamps. For that reason, ballasts must be designed to withstand these high ignition voltages. In this respect, special attention is paid to the insulation as well as the creepage and air clearance distances. As pulse ignition systems generate high-energy pulses, they are also suitable in the event of longer conductor distances between ignitor and lamp. State-of-the-art ignitors feature electronic circuitry. Depending on their design and the technical requirements, the simplest solution is to connect pulse ignitors in parallel with the lamp. Further models make partial use of the winding of a ballast, which will either feature multiple tapping points for voltage selection or special tapping points for pulse operation.

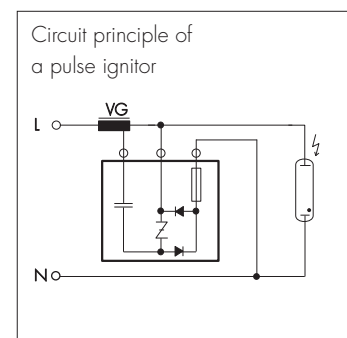
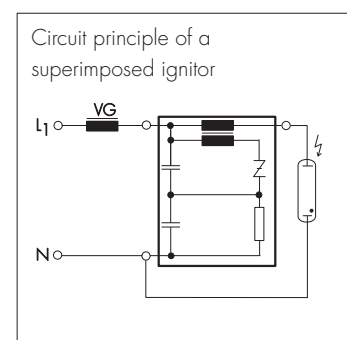

1

2

3

4

5

6

7

8

9

10

VS ignitors provide the following advantages:

- fully electronic construction
- compact design
- large nominal voltage range
- large output range
- low self-heating
- minimal power loss
- low noise
- long service life
- high electrical safety due to high-quality components (e.g. approved capacitors)
- highly heat-resistant (max. permissible casing temperature t_c : 105 °C for superimposed ignitors and 95 °C for pulse ignitors)
- highly fire-resistant potting compound (certified according to EN 60926 and UL 94-V0)
- environmentally compatible potting compound (waste key No. 57110)

Product range

Vossloh-Schwabe's product range covers superimposed and pulse ignitors in standard models and with automatic cut-outs. Superimposed ignitors with automatic cut-outs are available with various cut-out times and ignition voltage pulse mechanisms (A and D). In this respect, D-series ignitors featuring the intelligent pulse-pause mode (IPP) are the best solution in terms of ignition reliability and switching off defective lamps.

Electronic ignitors with integrated cut-outs capture data on ignition behaviour during the ignition process. These data, e.g. regarding ignition frequency or failure, serve to identify ageing lamps and to ensure the ignition process is reliably switched off after a defined period of time at the end of the lamp's service life or in the event of defective lamps. This reduces the negative consequences associated with defective lamps.

Superimposed and Pulse Ignitors with Automatic Cut-out

Ignitors with IPP technology and extended cut-out – D series

After connection to mains voltage, D series ignitors generate ignition voltage pulses that are controlled and if necessary switched off by the ignitor in accordance with the lamp's operating state, lamp recognition and the safe burning time. If the safe burning time is not attained after three consecutive ignition attempts, pulse generation will cease.

Appropriately programmed microprocessors enable these performance features of ignitors with IPP technology (Intelligent Pulse-Pause Mode) and extended cut-outs.

Z ... D20/

PZ ... D20 for HS, HI and C-HI lamps
programmed cut-out time: 1,216 seconds

Ignitors with IPP technology and extended cut-outs are available up to an output of 1,000 W.

Programmed cut-out function of VS ignitors



Ignitors with automatic cut-out – A series

After connection to mains voltage, A series ignitors supply a continuous stream of ignition voltage pulses until the lamp has ignited or the predefined cut-out time (sum of all ignition periods) has been reached if the lamp fails to ignite.

PZ ... A5 for HSI lamps
programmed cut-out time: ca. 300 seconds

Pulse ignition systems – overview of technical specifications

For HS, HI and C-HI lamps – PZ 1000 K D20

for high-pressure sodium lamps (HS) 50–1000 W,
metal halide lamps (HI) 35–1000 W and
for ceramic discharge tube lamps (C-HI) 35–400 W
Ignition voltage: 1.8–2.3 kV or 4–5 kV
No. of pulses: 2 per mains period
Load capacitance: 20–1000 pF
Ignitors with automatic cut-out and IPP technology
Suitable ballast types: NaHJ ... PZT with special winding tapping point,
whose position is determined by the magnitude of the ignition voltage

For HS lamps – PZS 1000 K

for standard high-pressure sodium lamps (HS) 50–1000 W
Not suitable for discharge lamp models SUPER, PLUS, XL, etc.
Ignition voltage: approx. 4 kV
No. of pulses: 1 per second
Load capacitance: 20–4000 pF
Suitable ballast types:
NaH ... P with winding tapping point
(20 V voltage difference)

For HI lamps – PZI 1000/1 K

for metal halide lamps (HI)
with an ignition voltage up to 0.9 kV
No. of pulses: 1 per mains period
Load capacitance: max. 10,000 pF
Suitable ballast models: Q...

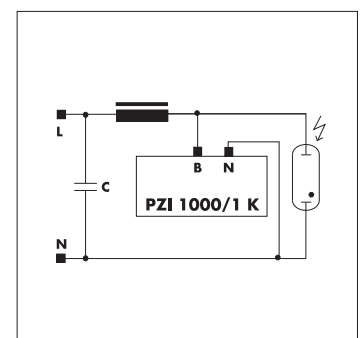
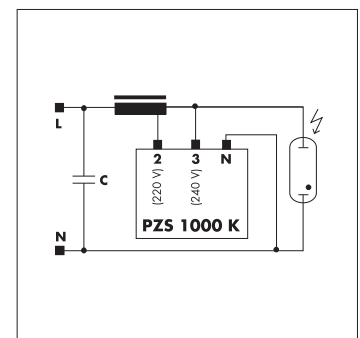
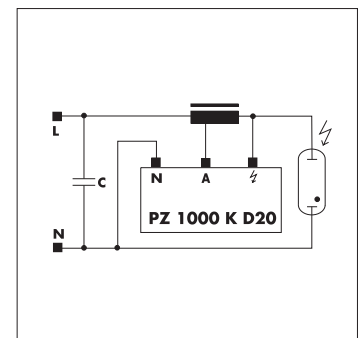

1

2

3

4

5

6

7

8

9

10

Assembly Instructions for Ignitors

For mounting and installing ignitors

Mandatory regulations

DIN VDE 0100	Erection of low voltage installations
EN 60598-1	Luminaires – part 1: general requirements and tests
EN 61347-1	Operating devices for lamps – part 1: general and safety requirements
EN 61347-2-1	Control gear for lamps; part 2-1: special requirements for ignitors (other than glow starters)
EN 60927	Control gear for lamps; ignitors (other than glow starters); performance requirements
EN 55015	Maximum values and methods of measurement for RFI suppression in electrical lighting installations and similar electrical appliances
EN 61000-3-2	Electromagnetic Compatibility (EMC) – part 3: maximum values – main section part 2: maximum values for mains harmonics (device input current up to and including 16 A per conductor)
EN 61547	Installations for general lighting purposes – EMC immunity requirements

Technical specifications

Operating voltage range

Ignitors can be operated at the specified mains voltage within a tolerance range of $\pm 10\%$.

Max. casing temperature t_c

A maximum casing temperature t_c of 105 °C or 95 °C is specified for superimposed ignitors and pulse ignitors, respectively. Tests carried out during operation must ensure this maximum value is not exceeded. Selecting an ignitor for higher lamp currents can reduce self-heating and thus also the temperature at the t_c measuring point. Details regarding self-heating can be found in the following table. The temperature structure in the luminaires is negatively influenced by ageing lamps.

Minimum ambient temperature t_a

The minimum ambient temperature t_a for all superimposed and pulse ignitors is -30 °C. Ignitors for use in applications with special requirements to the ambient temperature (for example -40 °C) are available on request.

Superimposed ignitors – Technical specifications

Voltage V/Hz	Ignitor type	Max. lamp current A	Power loss W	Inherent heating K	Ignition voltage kV	Max. load capacity pF	Max. conductor length between ignitor and lamp* m	Connection terminals (mm ²)		Casing material	Dimensions (dia. x L or L x W x H) length without threaded stud mm
								Screw	Push-in		
220–240/ 50–60	Z 70 S	2	< 0.6	< 5	1.8–2.3	200	2	0.75–4	—	Al	Ø35 x 76
	Z 70 K	2	< 0.6	< 5	1.8–2.3	200	2	0.75–4	—	PC	78 x 34 x 27 81 x 34 x 27
	Z 70 K D20	2	< 0.6	< 5	1.8–2.3	100	2	0.75–4	—	PC	80 x 34 x 30 83 x 34 x 30
	Z 250 S	3.5	< 1.8	< 20	4.0–5.0	100	1	0.75–4	—	Al	Ø35 x 76
	Z 250 K	3.5	< 1.8	< 20	4.0–5.0	100	1	0.75–4	—	PC	78 x 34 x 27 81 x 34 x 27
	Z 250 K D20	3.5	< 1.8	< 20	4.0–5.0	100	1	0.75–4	—	PC	80 x 34 x 30 83 x 34 x 30
	Z 400 S	5	< 3.0	< 25	4.0–5.0	100	1	0.75–4	—	Al	Ø45 x 76
	Z 400 M Z 400 M VS-Power Z 400 M S Z 400 M K	5	< 3.0	< 35	4.0–5.0	50	0.5	0.75–4	—	Al	Ø35 x 76
	Z 400 M K VS-Power	5	< 3.0	< 35	4.0–5.0	50	0.5	0.75–4	—	PC	78 x 34 x 27 81 x 34 x 27
	Z 400 S D20	5	< 3.0	< 25	4.0–5.0	100	1	0.75–4	—	Al	Ø45 x 90
	Z 400 M K D20	5	< 3.0	< 35	4.0–5.0	50	0.5	0.75–4	—	PC	80 x 34 x 30 83 x 34 x 30
	Z 750 S	8	< 3.0	< 20	4.0–5.0	100	1	0.75–2.5	—	Al	Ø50 x 90
	Z 1000 S Z 1000 TOP	12	< 6.0	< 35	4.0–5.0	100	1	0.75–2.5	—	Al	Ø50 x 80 83 x 83 x 68
	Z 1000 S D20	12	< 6.0	< 35	4.0–5.0	100	1	0.75–2.5	—	Al	Ø50 x 89
	Z 1000 L	12	< 6.0	< 35	4.0–5.0	2000	20	0.75–2.5	—	Al	Ø50 x 97
	Z 1200/2,5	15	< 7.5	< 40	2.0–2.5	200	2	0.75–2.5	—	Al	Ø50 x 80
	Z 1200/9	15	< 10.0	< 40	7.0–8.0	50	0.5	0.75–2.5	—	Al	Ø50 x 135
	Z 2000 S	20	< 6.0	< 30	4.0–5.0	100	1	0.75–2.5	—	Al	Ø65 x 96
380–420/ 50–60	Z 1000 S/400V	6	< 3.3	< 28	4.0–5.0	2000	20	0.75–2.5	—	Al	Ø45 x 84
	Z 2000 S/400V	12	< 5.0	< 32	4.0–5.0	2000	20	0.75–2.5	—	Al	Ø50 x 88
	Z 3500 S/400V	20	< 7.0	< 35	4.0–5.0	100	1	0.75–2.5	—	Al	Ø65 x 96

* With a conductor of, for instance, 100 pF per m (3x2.5 mm²)

Pulse ignitors – Technical specifications

Nominal voltage/ frequency V/Hz	Pulse ignitor type	Casing temperature t _c °C	Ignition voltage kV	Max. load capacity pF	Max. conductor length between ignitor and lamp* m	Connection screw terminals mm ²	Casing material	Dimensions (dia. x L or L x W x H) length without threaded stud mm
220–240/50–60	PZ 1000 K D20	95	1.8–2.3/ 4.0–5.0	1000	10	0.75–2.5	PC	74 x 34 x 27
220–240/50–60	PZI 1000/1 K	95	0.7–0.9	10000	100	0.5–2.5	PC	57 x 28 x 27
380–420/50–60	PZ 1000/400 V A5	95	4.0–5.0	800	8	0.75–2.5	Al	Ø40 x 80

* With a conductor of, for instance, 100 pF per m (3x2.5 mm²) – wiring must be taken into consideration

Mechanical mounting

Mounting position

Any

Mounting location

Ignitors are designed for installation in luminaires or comparable constructions. Ignitors must be protected against radiation of direct lamp heat by appropriate installation.

Clearance from lamp

The clearance needed between ignitor and lamp is determined by the load capacitance of the conductors and by the type of ignitor pulses. The table on page 101 gives details of the clearance needed for a typical 3-phase lead with a cross-section of 2.5 mm² per conductor.

Casing materials Unmarked in the type description: aluminium; marked "K": polycarbonate

Fastening Via threaded stud M8x10 (Z 2000 S, Z 3500 S/400 V: M12x12)

Dimensions The table on page 101 provides details of ignitor dimensions.

Electromagnetic compatibility (EMC)

Interference Ignitors only generate interference due to the high ignition voltages during lamp ignition. This is classified as click interference and is not evaluated in lighting technology. However, as this interference occurs continuously in the event of old lamps that fail to ignite, operators of lighting systems are legally obliged to exchange such lamps.

Interference immunity

Owing to their design and the materials used, VS ignitors are characterised by high interference immunity and comply with the specified maximum values.

Mains harmonics

Are not observed during lamp ignition. VS ignitors meet the requirements.

Reliability and service life

The service life of an ignitor is dependent on strict compliance with the casing temperature t_c during operation. As the ignitors are only subjected to loads during high-voltage lamp ignition, a service life of 10 years can be expected provided the t_c values are not exceeded. Failure rate: < 0.04%/1,000 hrs.

Electrical installation

Connection terminals

Ignitors feature screw or push-in terminals. For screw terminals a maximum torque value of 0.8 Nm must not be exceeded when connecting the conductor. Push-in terminals are for rigid conductors with a cross section of 0.5–2.5 mm² or respective flexible conductors with ferrule bare end of cores. Stripped lead ends of 8–9 mm are required. Tinned lead ends are not permitted. The permissible conductor cross-sections can be seen in the table on page 101.

Wiring

The ignitors must be wired between ballast and lamp in accordance with the circuit diagrams on pages 93–95. The load capacitances of the wiring must also be taken into account. Distances to lamps should be kept as short as possible.

Power switches for street lighting

In view of the drive to cut public spending on energy and also in the light of environmental policies to protect resources, reducing the power consumption of high-pressure discharge lamps is becoming increasingly important.

Power reduction is possible on high-pressure sodium vapour and mercury vapour lamps and is realised with the aid of electronic actuators or by switching the inductance in the luminaire itself with the aid of power switches.

Provided that the lamp still emits an acceptable minimum of light output and uniformity, these lamps can be used to reduce the lighting level of outdoor lighting systems during off-peak traffic periods (e.g. in accordance with DIN 5044 for street lighting). In conjunction with the appropriate ballasts, the VS power switches constitute a perfect all-round solution for power switching purposes. This VS system has been approved by leading lamp manufacturers.

Power switch PR 12 K LC – Power reduction without control line

The new VS PR 12 K LC power switch is capable of setting the period of power-reduced operation based on the measured burning time of a lighting system. This eliminates the time-consuming task of continually adjusting the times of power-reduced operation to suit constantly changing day-night cycles; it also removes the need for making adjustments due to daylight-saving times and is thus suitable for use worldwide (regionally independent).

Function

The intelligent PR 12 K LC power switch does not require a control line to reduce lamp output; it uses the tapping of the ballast. Thanks to an integrated microprocessor, the PR 12 K LC power switch can measure the burning time of the luminaire. This value is then compared to data stored on the chip and used to set the time at which the luminaire will switch over to power-reduced operation. The luminaire will be operated at reduced power for a minimum of six hours (reduced by approx. 40% of the lamp's nominal rating at 50% of luminous flux). This period of power reduction can be extended to a maximum of 10 hours.

Setting periods of power-reduced operation

The power switch is delivered in its default setting – i.e. the dial is set to 'Test (Code 0)'. After the luminaire has been installed, the desired power reduction time must be set using the dial on the power switch. The power-reduction period can be set to a minimum of six hours and can be extended by up to two hours in both directions (i.e. earlier or later). This results in a maximum power-reduction period of 10 hours.

The dial enables the following settings:

Dial settings		t ₁	Basic power	t ₂	Total power
Position	Timings	Hours	reduction period (hrs)	Hours	reduction time (hrs)
0	Test	Factory setting: 5 seconds on full load, followed by power reduction			
1	0/0	0	6	0	6
2	0/1	0	6	1	7
3	0/2	0	6	2	8
4	0.5/0	0.5	6	0	6.5
5	0.5/1	0.5	6	1	7.5
6	0.5/2	0.5	6	2	8.5
7	1/0	1	6	0	7
8	1/1	1	6	1	8
9	1/2	1	6	2	9
A	1.5/0	1.5	6	0	7.5
B	1.5/1	1.5	6	1	8.5
C	1.5/2	1.5	6	2	9.5
D	2/0	2	6	0	8
E	2/1	2	6	1	9
F	2/2	2	6	2	10

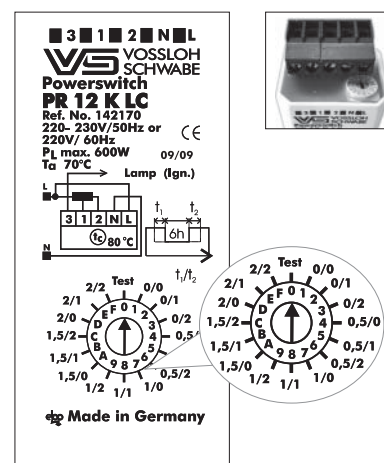

1

2

3

4

5

6

7

8

9

10

Determining operating/power reduction periods

- The dial is set to the desired period of power reduction, e.g. to position 1 (0/0), which corresponds to a power-reduction period of six hours.
- In the first night, the luminaire is activated by the twilight switch (e.g. at 20:30 hours) and will operate at its nominal rating. After four hours (default setting), the luminaire will be switched down by 40% of the lamp output by the power switch and will then remain in power-reduced operation until the twilight switch turns the system off (e.g. at 06:30 hours).
- During this time, the power switch will measure the entire burning time of the lamp (10 hours in our example).
- The power switch then compares the measured burning period with values stored on the microprocessor. The integrated comparative values of the power switch form the basis for the starting point of power-reduced operation for the following night. The "new" starting time will then be stored by the power switch until the following night.
- In the second night, the lighting system – controlled by the twilight switch and thus dependent on the day/night cycle of the respective region and the time of year – will be activated (and deactivated) at a slightly different time as compared to the first night (either earlier or later, depending on the season)
- With the dial set to position 1, the power switch will thus activate the six-hour period of power-reduced operation after two hours, as per our example, and will then revert to nominal operation before the twilight switch finally sends the signal to switch the lighting system off.
- During the night, the power switch will again measure the entire burning time, compare this value with the stored values and then reset the starting time for power-reduced operation.
- The period of power-reduced operation can be adjusted by changing the dial setting. This period can be extended in both directions (i.e. earlier or later) as detailed in the table on page 103.
- If the dial is, for instance, set to 9 (1/2) this will produce a total period of power-reduced operation of 9 hours (1+6+2). As a result, power-reduced operation will begin one hour earlier than the value determined the night before would ordinarily prescribe and will then extend the minimum period of power-reduced operation by two hours.
- If, in very rare cases, the total burning period of the lighting system should remain under six hours per night, the power switch will activate power-reduced operation after 15 minutes of nominal operation and stay in power-reduced mode until the lighting system is switched off. Switching diagram for power reduced operation.

Switching diagram for power reduced operation

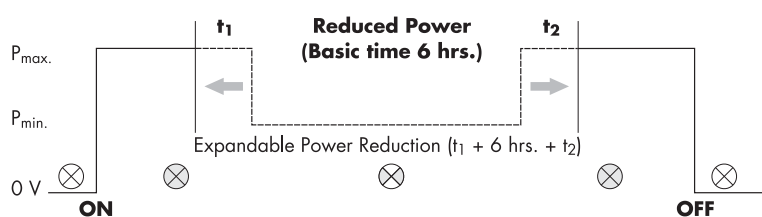

Deactivating reduced-power operation for the night

The functional scope of the PR 12 K LC power switch has been extended with an extra function that permits the operator to deactivate reduced-power operation of the lighting system for a single night. The function can be useful for local festivities or events (e.g. town fêtes) during which it would not be appropriate to operate the local street lighting system at reduced power for safety reasons.

The power switch can be easily programmed to operate the lighting system at normal (i.e. 100%) power for the immediately following night cycle. The power switch is programmed by briefly switching the lighting system on for a period of min. 60 and max. 90 seconds during the day of the event and then switching it off again. The intelligent power switch recognises this command and sets the usual reduced-power operation to zero. The power switch can be successively programmed in this manner as many days in a row as necessary. For every night the lighting system is to be operated at normal (100%) power, the lighting system will have to be switched on for a period of min. 60 and max. 90 seconds during the day. The lighting system will be operated at normal (100%) power in the respective night following day-time activation of the extra function.

The power switch does not need to be reprogrammed to return to power-reduced operation of the lighting system. The power switch will automatically return to its original (power-reducing) program if the lighting system is not switched on during the day for a period of min. 60 and max. 90 seconds.

Before testing the extra function, it is important to ensure that the power switch has been in operation for at least one night cycle. Only then will the "learning cycle" start that is required to perform the basic function. After that, the extra function can be activated as described above.

Luminaire testing

The "Test (Code 0)" dial setting on the power switch is used for luminaire testing during production as well as for direct function tests for "subsequent" installation in the lighting system. After the luminaire is switched on, the lamp is first operated at its nominal rating. After only five seconds, the system will be switched over to power-reduced operation, which will produce a visible change even though the lamp will not yet have attained its full output.

Maintenance work on the lighting system

Maintenance work that requires the lighting system to be switched on for a period of less than two hours will not influence the settings of power switch PR 12 K LC. Should the lighting system need to be switched on for more than two hours during maintenance work, the PR 12 K LC power switch will activate power-reduced operation after 15 minutes of nominal operation in the following night and will then start to re-measure the total burning time of the lighting system. To determine the starting time of power-reduced operation for subsequent nights, the power switch will again use the stored comparative values.

Switch Units

For power reduction using electronic ballasts with a 1–10 V interface

Suitable for a broad range of lamps

Vossloh-Schwabe's switch units are designed to enable one-step power reduction of lamps (FL, CFL, LED, HS, HI and C-HI) with the help of the respective electronic ballast or converter. To this end, the switch units utilise the 1–10 V interface of the control gear unit. The switch unit is mainly intended for outdoor luminaires in systems with or without a control phase.

Discharge lamps may only be operated at reduced power if they have been expressly approved for this purpose by the manufacturer. In addition, the unit can also be used to dim tubular and compact fluorescent lamps as well as LEDs.

The 1–10 V interface is addressed via an external circuit at the output of the switch unit using a suitably dimensioned resistor. The type of resistor and circuitry are selected by the luminaire manufacturer to suit the desired degree of power reduction.

The switch unit satisfies the provisions of DIN EN 61347 and is suitable for use in outdoor luminaires of protection classes I and II.

1

2

3

4

5

6

7

8

9

10

Function PR 1-10 V K LC

The intelligent PR 1-10 V K LC switch unit does not require a control line to reduce lamp output.

Thanks to an integrated microprocessor, the PR 1-10 V K LC switch unit can measure the burning time of the luminaire. This value is then compared to data stored on the chip and used to set the time at which the luminaire will switch over to power-reduced operation.

The luminaire will be operated at reduced power for a minimum of six hours (reduced by approx. 40% of the lamp's nominal rating at 50% of luminous flux). This period of power reduction can be extended to a maximum of 10 hours.

Setting periods of power-reduced operation for PR 1-10 V K LC

The PR 1-10 V K LC switch unit is delivered in its default setting – i.e. the dial is set to 'Test (Code 0)'. After the luminaire has been installed, the desired power reduction time must be set using the dial on the switch unit. The power-reduction period can be set to a minimum of six hours and can be extended by up to two hours in both directions (i.e. earlier or later). This results in a maximum power-reduction period of 10 hours.

The dial enables the following settings:

Dial Settings Position	Timings	t1 Hours	Basic power reduction period (hrs)	t2 Hours	Total power reduction time (hrs)
0	Test	Factory setting: 5 seconds on full load, followed by power reduction			
1	0/0	0	6	0	6
2	0/1	0	6	1	7
3	0/2	0	6	2	8
4	0.5/0	0.5	6	0	6.5
5	0.5/1	0.5	6	1	7.5
6	0.5/2	0.5	6	2	8.5
7	1/0	1	6	0	7
8	1/1	1	6	1	8
9	1/2	1	6	2	9
A	1.5/0	1.5	6	0	7.5
B	1.5/1	1.5	6	1	8.5
C	1.5/2	1.5	6	2	9.5
D	2/0	2	6	0	8
E	2/1	2	6	1	9
F	2/2	2	6	2	10

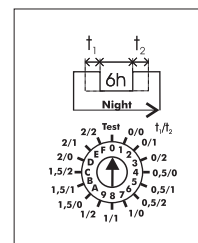
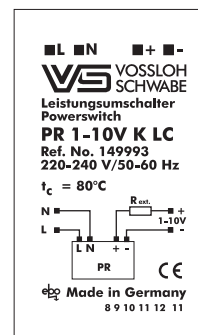

Circuit diagrams for switch units

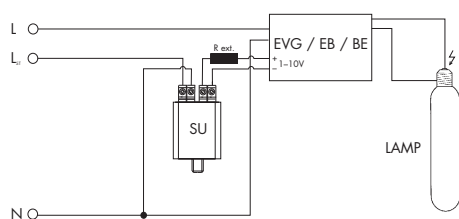

SU 1-10 V K

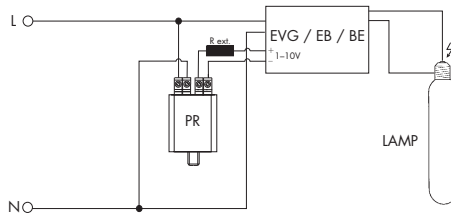

PR 1-10 V K LC

Lamp Table for Discharge Lamps

High-pressure sodium lamps (HS lamps)

Manufacturer	Designation	Base	Lamp current	Superimposed ignition system		Pulse ignition system		Instant restrike ignition system		Control gear unit	EB
				Ignitor	Ballast	Ignitor	Ballast	Ignitor	Ballast		
Lamp output 35 W											
Philips	SDW-T	PG12-1	0.48	ignitor/ stabiliser	NaH 35II	—	—	—	—	—	—
Sylvania	SHPS...CO/E	E27	0.53	Z 70...	NaHJ 35	PZ 1000KD20	NaHJ 35PZT	—	—	—	—
Lamp output 50 W											
Aura	ST 50 W	E27	0.80	Z 70...	NaH 50	PZ 1000KD20	NaH 50PZT	—	—	VNaH 50	—
Aura	SE 50 W	E27	0.80	Z 70...	NaH 50	PZ 1000KD20	NaH 50PZT	—	—	VNaH 50	—
GE	LU...	E27	0.76	Z 70...	NaH 50	PZ 1000KD20	—	—	—	—	—
GE	LU...XO	E27	0.76	Z 70...	NaH 50	PZ 1000KD20	—	—	—	—	—
GE	LU...SBY	E27	0.76	Z 70...	NaH 50	PZ 1000KD20	—	—	—	—	—
Iwasaki	NH.../HW/...	E27	0.76	Z 70...	NaH 50	PZ 1000KD20	—	—	—	—	—
Narva	NA	E27	0.76	Z 70...	NaH 50	PZ 1000KD20	—	—	—	—	—
Narva	NA...D	E27	0.76	Z 70...	NaH 50	PZ 1000KD20	—	—	—	—	—
Osram	NAVE.../E	E27	0.76	Z 70...	NaH 50	PZ 1000KD20	—	—	—	—	—
Osram	NAVE...4Y	E27	0.76	Z 70...	NaH 50	PZ 1000KD20	—	—	—	—	—
Osram	NAV-T...Super 4Y	E27	0.76	Z 70...	NaH 50	PZ 1000KD20	—	—	—	—	—
Philips	SDW-T	PG12-1	0.78	ignitor/ stabiliser	NaH 50II	—	—	—	—	—	—
Philips	SON...Hg free	E27	0.76	Z 70...	NaH 50	PZ 1000KD20	—	—	—	—	—
Philips	SON...Pro	E27	0.76	Z 70...	NaH 50	PZ 1000KD20	—	—	—	—	—
Philips	SON-T...Plus	E27	0.76	Z 70...	NaH 50	PZ 1000KD20	—	—	—	—	—
Radium	RNP	E27	0.76	Z 70...	NaH 50	PZ 1000KD20	—	—	—	—	—
Sylvania	SHPS	E27	0.76	Z 70...	NaH 50	PZ 1000KD20	—	—	—	—	—
Sylvania	SHP-TS	E27	0.76	Z 70...	NaH 50	PZ 1000KD20	—	—	—	—	—
Lamp output 70 W											
Aura	ST 70 W	E27	0.98	Z 70...	NaHJ 70	PZ 1000KD20	NaHJ 70PZT	—	—	VNaHJ 70	—
Aura	SE 70 W	E27	0.98	Z 70...	NaHJ 70	PZ 1000KD20	NaHJ 70PZT	—	—	VNaHJ 70	—
BLV	HST-SE	E27	0.98	Z 70...	NaHJ 70	PZ 1000KD20	NaHJ 70PZT	—	—	VNaHJ 70	—
GE	LU	E27	0.98	Z 70...	NaHJ 70	PZ 1000KD20	NaHJ 70PZT	—	—	VNaHJ 70	—
GE	LU...RFL	E27	0.98	Z 70...	NaHJ 70	PZ 1000KD20	NaHJ 70PZT	—	—	VNaHJ 70	—
GE	LU...SBY	E27	0.98	Z 70...	NaHJ 70	PZ 1000KD20	NaHJ 70PZT	—	—	VNaHJ 70	—
GE	LU...XO	E27	0.98	Z 70...	NaHJ 70	PZ 1000KD20	NaHJ 70PZT	—	—	VNaHJ 70	—
Iwasaki	NH.../HW/...	E27	0.98	Z 70...	NaHJ 70	PZ 1000KD20	NaHJ 70PZT	—	—	VNaHJ 70	—
Narva	NA	E27	0.98	Z 70...	NaHJ 70	PZ 1000KD20	NaHJ 70PZT	—	—	VNaHJ 70	—
Narva	NA...D	E27	0.98	Z 70...	NaHJ 70	PZ 1000KD20	NaHJ 70PZT	—	—	VNaHJ 70	—
Osram	NAVE.../E	E27	0.98	Z 70...	NaHJ 70	PZ 1000KD20	NaHJ 70PZT	—	—	VNaHJ 70	—
Osram	NAVE...4Y	E27	0.98	Z 70...	NaHJ 70	PZ 1000KD20	NaHJ 70PZT	—	—	VNaHJ 70	—
Osram	NAV-T	E27	0.98	Z 70...	NaHJ 70	PZ 1000KD20	NaHJ 70PZT	—	—	VNaHJ 70	—
Osram	NAV-T...4Y	E27	0.98	Z 70...	NaHJ 70	PZ 1000KD20	NaHJ 70PZT	—	—	VNaHJ 70	—
Osram	NAV-T...Super 4Y	E27	0.98	Z 70...	NaHJ 70	PZ 1000KD20	NaHJ 70PZT	—	—	VNaHJ 70	—
Osram	NAV-TS...Super 4Y	RX7s	0.98	Z 400...	NaHJ 70	PZ 1000KD20	NaHJ 70PZT	HZ 600K	NaHJ 70	VNaHJ 70	—
Philips	SON...Hg free	E27	0.98	Z 70...	NaHJ 70	PZ 1000KD20	NaHJ 70PZT	—	—	VNaHJ 70	—
Philips	SON...Pro	E27	0.98	Z 70...	NaHJ 70	PZ 1000KD20	NaHJ 70PZT	—	—	VNaHJ 70	—
Philips	SON-T...Plus	E27	0.98	Z 70...	NaHJ 70	PZ 1000KD20	NaHJ 70PZT	—	—	VNaHJ 70	—
Philips	SON-T...Pro	E27	0.98	Z 70...	NaHJ 70	PZ 1000KD20	NaHJ 70PZT	—	—	VNaHJ 70	—
Radium	RNPE	E27	0.98	Z 70...	NaHJ 70	PZ 1000KD20	NaHJ 70PZT	—	—	VNaHJ 70	—
Radium	RNP-T	E27	0.98	Z 70...	NaHJ 70	PZ 1000KD20	NaHJ 70PZT	—	—	VNaHJ 70	—
Radium	RNP-TS	RX7s	0.98	Z 400...	NaHJ 70	PZ 1000KD20	NaHJ 70PZT	HZ 600K	NaHJ 70	VNaHJ 70	—
Sylvania	SHP	E27	0.98	Z 70...	NaHJ 70	PZ 1000KD20	NaHJ 70PZT	—	—	VNaHJ 70	—
Sylvania	SHP-T	E27	0.98	Z 70...	NaHJ 70	PZ 1000KD20	NaHJ 70PZT	—	—	VNaHJ 70	—
Sylvania	SHP-TS	E27	0.98	Z 70...	NaHJ 70	PZ 1000KD20	NaHJ 70PZT	—	—	VNaHJ 70	—
Sylvania	SHP.../COE	E27	0.98	Z 70...	NaHJ 70	PZ 1000KD20	NaHJ 70PZT	—	—	VNaHJ 70	—
Sylvania	SHP-S	E27	0.98	Z 70...	NaHJ 70	PZ 1000KD20	NaHJ 70PZT	—	—	VNaHJ 70	—
Lamp output 100 W											
Aura	ST 100 W	E40	1.20	Z 250..., Z 400...	NaHJ 100	PZ 1000KD20	NaHJ 100PZT	—	—	VNaHJ 100	—
Aura	SE 100 W	E40	1.20	Z 250..., Z 400...	NaHJ 100	PZ 1000KD20	NaHJ 100PZT	—	—	VNaHJ 100	—
BLV	HST-SE	E40	1.20	Z 250..., Z 400...	NaHJ 100	PZ 1000KD20	NaHJ 100PZT	—	—	VNaHJ 100	—
GE	LU	E40	1.20	Z 250..., Z 400...	NaHJ 100	PZ 1000KD20	NaHJ 100PZT	—	—	VNaHJ 100	—
GE	LU...SBY	E40	1.20	Z 250..., Z 400...	NaHJ 100	PZ 1000KD20	NaHJ 100PZT	—	—	VNaHJ 100	—
GE	LU...XO	E40	1.20	Z 250..., Z 400...	NaHJ 100	PZ 1000KD20	NaHJ 100PZT	—	—	VNaHJ 100	—
Iwasaki	NH...F	E40	1.20	Z 250..., Z 400...	NaHJ 100	PZ 1000KD20	NaHJ 100PZT	—	—	VNaHJ 100	—
Iwasaki	NHT...F	E40	1.20	Z 250..., Z 400...	NaHJ 100	PZ 1000KD20	NaHJ 100PZT	—	—	VNaHJ 100	—
Narva	NA	E40	1.20	Z 250..., Z 400...	NaHJ 100	PZ 1000KD20	NaHJ 100PZT	—	—	VNaHJ 100	—

Lamp Table for Discharge Lamps

High-pressure sodium lamps (HS lamps)

Manufacturer	Designation	Base	Lamp current	Superimposed ignition system		Pulse ignition system		Instant restrike ignition system		Control gear unit	EB
				Ignitor	Ballast	Ignitor	Ballast	Ignitor	Ballast		
Lamp output 100 W											
Narva	NA...D	E40	1.20	Z 250..., Z 400...	NaHj 100	PZ 1000KD20	NaHj 100PZT	—	—	VNaHj 100	—
Osram	NAVE	E40	1.20	Z 250..., Z 400...	NaHj 100	PZ 1000KD20	NaHj 100PZT	—	—	VNaHj 100	—
Osram	NAVE...Super 4Y	E40	1.20	Z 250..., Z 400...	NaHj 100	PZ 1000KD20	NaHj 100PZT	—	—	VNaHj 100	—
Osram	NAVT	E40	1.20	Z 250..., Z 400...	NaHj 100	PZ 1000KD20	NaHj 100PZT	—	—	VNaHj 100	—
Osram	NAVT...Super 4Y	E40	1.20	Z 250..., Z 400...	NaHj 100	PZ 1000KD20	NaHj 100PZT	—	—	VNaHj 100	—
Philips	SDWT	PG12-1	1.30	ignitor/ stabiliser	NaH 100II	—	—	—	—	—	—
Philips	SON...Plus	E40	1.20	Z 250..., Z 400...	NaHj 100	PZ 1000KD20	NaHj 100PZT	—	—	VNaHj 100	—
Philips	SON...Pro	E40	1.20	Z 250..., Z 400...	NaHj 100	PZ 1000KD20	NaHj 100PZT	—	—	VNaHj 100	—
Philips	SON-T...Hg free	E40	1.20	Z 250..., Z 400...	NaHj 100	PZ 1000KD20	NaHj 100PZT	—	—	VNaHj 100	—
Philips	SON-T...Plus	E40	1.20	Z 250..., Z 400...	NaHj 100	PZ 1000KD20	NaHj 100PZT	—	—	VNaHj 100	—
Philips	SON-T...Pro	E40	1.20	Z 250..., Z 400...	NaHj 100	PZ 1000KD20	NaHj 100PZT	—	—	VNaHj 100	—
Radium	RNPE	E40	1.20	Z 250..., Z 400...	NaHj 100	PZ 1000KD20	NaHj 100PZT	—	—	VNaHj 100	—
Radium	RNP-T	E40	1.20	Z 250..., Z 400...	NaHj 100	PZ 1000KD20	NaHj 100PZT	—	—	VNaHj 100	—
Sylvania	SHPS	E40	1.20	Z 250..., Z 400...	NaHj 100	PZ 1000KD20	NaHj 100PZT	—	—	VNaHj 100	—
Sylvania	SHP-T	E40	1.20	Z 250..., Z 400...	NaHj 100	PZ 1000KD20	NaHj 100PZT	—	—	VNaHj 100	—
Sylvania	SHP-TS	E40	1.20	Z 250..., Z 400...	NaHj 100	PZ 1000KD20	NaHj 100PZT	—	—	VNaHj 100	—
Lamp output 150 W											
Aura	ST 150 W	E40	1.80	Z 250..., Z 400...	NaHj 150	PZ 1000KD20	NaHj 150PZT	—	—	VNaHj 150	—
Aura	SE 150 W	E40	1.80	Z 250..., Z 400...	NaHj 150	PZ 1000KD20	NaHj 150PZT	—	—	VNaHj 150	—
BLV	HSTDE	Fc2	1.80	Z 250..., Z 400...	NaHj 150	PZ 1000KD20	NaHj 150PZT	HZ 600K	NaHj 150	VNaHj 150	—
BLV	HSTDE	RX7s	1.80	Z 250..., Z 400...	NaHj 150	PZ 1000KD20	NaHj 150PZT	HZ 600K	NaHj 150	VNaHj 150	—
BLV	HSTSE	E40	1.80	Z 250..., Z 400...	NaHj 150	PZ 1000KD20	NaHj 150PZT	—	—	VNaHj 150	—
GE	LU	E40	1.80	Z 250..., Z 400...	NaHj 150	PZ 1000KD20	NaHj 150PZT	—	—	VNaHj 150	—
GE	LU...SBY	E40	1.80	Z 250..., Z 400...	NaHj 150	PZ 1000KD20	NaHj 150PZT	—	—	VNaHj 150	—
GE	LU...XO	E40	1.80	Z 250..., Z 400...	NaHj 150	PZ 1000KD20	NaHj 150PZT	—	—	VNaHj 150	—
Iwasaki	NH	E40	1.80	Z 250..., Z 400...	NaHj 150	PZ 1000KD20	NaHj 150PZT	—	—	VNaHj 150	—
Iwasaki	NHT	E40	1.80	Z 250..., Z 400...	NaHj 150	PZ 1000KD20	NaHj 150PZT	—	—	VNaHj 150	—
Narva	NA	E40	1.80	Z 250..., Z 400...	NaHj 150	PZ 1000KD20	NaHj 150PZT	—	—	VNaHj 150	—
Narva	NA...D	E40	1.80	Z 250..., Z 400...	NaHj 150	PZ 1000KD20	NaHj 150PZT	—	—	VNaHj 150	—
Osram	NAVE	E40	1.80	Z 250..., Z 400...	NaHj 150	PZ 1000KD20	NaHj 150PZT	—	—	VNaHj 150	—
Osram	NAVE...4Y	E40	1.80	Z 250..., Z 400...	NaHj 150	PZ 1000KD20	NaHj 150PZT	—	—	VNaHj 150	—
Osram	NAVE...Super 4Y	E40	1.80	Z 250..., Z 400...	NaHj 150	PZ 1000KD20	NaHj 150PZT	—	—	VNaHj 150	—
Osram	NAVT	E40	1.80	Z 250..., Z 400...	NaHj 150	PZ 1000KD20	NaHj 150PZT	—	—	VNaHj 150	—
Osram	NAVT...4Y	E40	1.80	Z 250..., Z 400...	NaHj 150	PZ 1000KD20	NaHj 150PZT	—	—	VNaHj 150	—
Osram	NAVT...Super 4Y	E40	1.80	Z 250..., Z 400...	NaHj 150	PZ 1000KD20	NaHj 150PZT	—	—	VNaHj 150	—
Osram	NAVT...Super 4Y	E40	1.80	Z 250..., Z 400...	NaHj 150	PZ 1000KD20	NaHj 150PZT	—	—	VNaHj 150	—
Osram	NAVT...Super 4Y	RX7s	1.80	Z 250..., Z 400...	NaHj 150	PZ 1000KD20	NaHj 150PZT	HZ 600K	NaHj 150	VNaHj 150	—
Philips	SON...Hg free	E40	1.80	Z 250..., Z 400...	NaHj 150	PZ 1000KD20	NaHj 150PZT	—	—	VNaHj 150	—
Philips	SON...Plus	E40	1.80	Z 250..., Z 400...	NaHj 150	PZ 1000KD20	NaHj 150PZT	—	—	VNaHj 150	—
Philips	SON...Pro	E40	1.80	Z 250..., Z 400...	NaHj 150	PZ 1000KD20	NaHj 150PZT	—	—	VNaHj 150	—
Philips	SON...Comfort Pro	E40	1.82	Z 250..., Z 400...	NaHj 150	PZ 1000KD20	NaHj 150PZT	—	—	VNaHj 150	—
Philips	SON-T...Hg free	E40	1.80	Z 250..., Z 400...	NaHj 150	PZ 1000KD20	NaHj 150PZT	—	—	VNaHj 150	—
Philips	SON-T...Plus	E40	1.80	Z 250..., Z 400...	NaHj 150	PZ 1000KD20	NaHj 150PZT	—	—	VNaHj 150	—
Philips	SON-T...Pro	E40	1.80	Z 250..., Z 400...	NaHj 150	PZ 1000KD20	NaHj 150PZT	—	—	VNaHj 150	—
Philips	SON-T...Comfort Pro	E40	1.80	Z 250..., Z 400...	NaHj 150	PZ 1000KD20	NaHj 150PZT	—	—	VNaHj 150	—
Radium	RNPE	E40	1.80	Z 250..., Z 400...	NaHj 150	PZ 1000KD20	NaHj 150PZT	—	—	VNaHj 150	—
Radium	RNP-T	E40	1.80	Z 250..., Z 400...	NaHj 150	PZ 1000KD20	NaHj 150PZT	—	—	VNaHj 150	—
Radium	RNP-TS	RX7s	1.80	Z 250..., Z 400...	NaHj 150	PZ 1000KD20	NaHj 150PZT	HZ 600K	NaHj 150	VNaHj 150	—
Sylvania	SHPS	E40	1.80	Z 250..., Z 400...	NaHj 150	PZ 1000KD20	NaHj 150PZT	—	—	VNaHj 150	—
Sylvania	SHP-T	E40	1.80	Z 250..., Z 400...	NaHj 150	PZ 1000KD20	NaHj 150PZT	—	—	VNaHj 150	—
Sylvania	SHP-TS	E40	1.80	Z 250..., Z 400...	NaHj 150	PZ 1000KD20	NaHj 150PZT	—	—	VNaHj 150	—
Lamp output 250 W											
Aura	ST 250 W	E40	3.00	Z 250..., Z 400...	NaHj 250	PZ 1000KD20	NaHj 250PZT	—	—	VNaHj 250	—
Aura	SE 250 W	E40	3.00	Z 250..., Z 400...	NaHj 250	PZ 1000KD20	NaHj 250PZT	—	—	VNaHj 250	—
BLV	HSTDE	RX7s	3.00	Z 250..., Z 400...	NaHj 250	PZ 1000KD20	NaHj 250PZT	HZ 600K	NaHj 250	VNaHj 250	—
BLV	HSTSE	E40	3.00	Z 250..., Z 400...	NaHj 250	PZ 1000KD20	NaHj 250PZT	—	—	VNaHj 250	—
GE	LU	E40	3.00	Z 250..., Z 400...	NaHj 250	PZ 1000KD20	NaHj 250PZT	—	—	VNaHj 250	—
GE	LU...SBY	E40	3.00	Z 250..., Z 400...	NaHj 250	PZ 1000KD20	NaHj 250PZT	—	—	VNaHj 250	—
GE	LU...TD	RX7s	2.95	Z 250..., Z 400...	NaHj 250	PZ 1000KD20	NaHj 250PZT	HZ 600K	NaHj 250	VNaHj 250	—
GE	LU...XO	E40	2.95	Z 250..., Z 400...	NaHj 250	PZ 1000KD20	NaHj 250PZT	—	—	VNaHj 250	—
Iwasaki	NH	E40	3.00	Z 250..., Z 400...	NaHj 250	PZ 1000KD20	NaHj 250PZT	—	—	VNaHj 250	—
Iwasaki	NHT	E40	3.00	Z 250..., Z 400...	NaHj 250	PZ 1000KD20	NaHj 250PZT	—	—	VNaHj 250	—

Lamp Table for Discharge Lamps

High-pressure sodium lamps (HS lamps)

Manufacturer	Designation	Base	Lamp current	Superimposed ignition system		Pulse ignition system		Instant restrike ignition system		Control gear unit	EB
				Ignitor	Ballast	Ignitor	Ballast	Ignitor	Ballast		
Lamp output 250 W											
Narva	NA	E40	3.00	Z 250..., Z 400...	NaHj 250	PZ 1000KD20	NaHj 250PZT	—	—	VNaHj 250	—
Narva	NA...D	E40	3.00	Z 250..., Z 400...	NaHj 250	PZ 1000KD20	NaHj 250PZT	—	—	VNaHj 250	—
Osram	NAVE	E40	3.00	Z 250..., Z 400...	NaHj 250	PZ 1000KD20	NaHj 250PZT	—	—	VNaHj 250	—
Osram	NAVE...4Y	E40	3.00	Z 250..., Z 400...	NaHj 250	PZ 1000KD20	NaHj 250PZT	—	—	VNaHj 250	—
Osram	NAVE...Super 4Y	E40	3.00	Z 250..., Z 400...	NaHj 250	PZ 1000KD20	NaHj 250PZT	—	—	VNaHj 250	—
Osram	NAV-T	E40	3.00	Z 250..., Z 400...	NaHj 250	PZ 1000KD20	NaHj 250PZT	—	—	VNaHj 250	—
Osram	NAV-T...4Y	E40	3.00	Z 250..., Z 400...	NaHj 250	PZ 1000KD20	NaHj 250PZT	—	—	VNaHj 250	—
Osram	NAV-T...Super 4Y	E40	3.00	Z 250..., Z 400...	NaHj 250	PZ 1000KD20	NaHj 250PZT	—	—	VNaHj 250	—
Osram	NAV-TS	RX7s	3.00	Z 250..., Z 400...	NaHj 250	PZ 1000KD20	NaHj 250PZT	HZ 600K	NaHj 250	VNaHj 250	—
Philips	SON...Hg free	E40	3.00	Z 250..., Z 400...	NaHj 250	PZ 1000KD20	NaHj 250PZT	—	—	VNaHj 250	—
Philips	SON...Plus	E40	3.00	Z 250..., Z 400...	NaHj 250	PZ 1000KD20	NaHj 250PZT	—	—	VNaHj 250	—
Philips	SON...Pro	E40	3.00	Z 250..., Z 400...	NaHj 250	PZ 1000KD20	NaHj 250PZT	—	—	VNaHj 250	—
Philips	SON...Comfort Pro	E40	3.00	Z 250..., Z 400...	NaHj 250	PZ 1000KD20	NaHj 250PZT	—	—	VNaHj 250	—
Philips	SON-T...Hg free	E40	3.00	Z 250..., Z 400...	NaHj 250	PZ 1000KD20	NaHj 250PZT	—	—	VNaHj 250	—
Philips	SON-T...Plus	E40	3.00	Z 250..., Z 400...	NaHj 250	PZ 1000KD20	NaHj 250PZT	—	—	VNaHj 250	—
Philips	SON-T...Pro	E40	3.00	Z 250..., Z 400...	NaHj 250	PZ 1000KD20	NaHj 250PZT	—	—	VNaHj 250	—
Philips	SON-T...Comfort Pro	E40	3.00	Z 250..., Z 400...	NaHj 250	PZ 1000KD20	NaHj 250PZT	—	—	VNaHj 250	—
Radium	RNPE	E40	3.00	Z 250..., Z 400...	NaHj 250	PZ 1000KD20	NaHj 250PZT	—	—	VNaHj 250	—
Radium	RNP-T	E40	3.00	Z 250..., Z 400...	NaHj 250	PZ 1000KD20	NaHj 250PZT	—	—	VNaHj 250	—
Sylvania	SHP	E40	3.00	Z 250..., Z 400...	NaHj 250	PZ 1000KD20	NaHj 250PZT	—	—	VNaHj 250	—
Sylvania	SHP-T	E40	3.00	Z 250..., Z 400...	NaHj 250	PZ 1000KD20	NaHj 250PZT	—	—	VNaHj 250	—
Sylvania	SHP-S	E40	2.95	Z 250..., Z 400...	NaHj 250	PZ 1000KD20	NaHj 250PZT	—	—	VNaHj 250	—
Sylvania	SHP-TS	E40	2.95	Z 250..., Z 400...	NaHj 250	PZ 1000KD20	NaHj 250PZT	—	—	VNaHj 250	—
Lamp output 400 W											
Aura	ST 400 W	E40	4.40	Z 400..., Z 1000...	NaHj 400	PZ 1000KD20	NaHj 400PZT	—	—	VNaHj 400	—
Aura	SE 400 W	E40	4.40	Z 400..., Z 1000...	NaHj 400	PZ 1000KD20	NaHj 400PZT	—	—	VNaHj 400	—
BLV	HSTDE	RX7s	4.40	Z 400..., Z 1000...	NaHj 400	PZ 1000KD20	NaHj 400PZT	HZ 600K	NaHj 400	VNaHj 400	—
BLV	HSTSE	E40	4.40	Z 400..., Z 1000...	NaHj 400	PZ 1000KD20	NaHj 400PZT	—	—	VNaHj 400	—
GE	IU	E40	4.60	Z 400..., Z 1000...	NaHj 400	PZ 1000KD20	NaHj 400PZT	—	—	VNaHj 400	—
GE	IU...PSL	E40	4.30	Z 400..., Z 1000...	NaHj 400	PZ 1000KD20	NaHj 400PZT	—	—	VNaHj 400	—
GE	IU...SBY	E40	4.45	Z 400..., Z 1000...	NaHj 400	PZ 1000KD20	NaHj 400PZT	—	—	VNaHj 400	—
GE	IU...TD	RX7s	4.40	Z 400..., Z 1000...	NaHj 400	PZ 1000KD20	NaHj 400PZT	HZ 600K	NaHj 400	VNaHj 400	—
GE	IU...XO	E40	4.50	Z 400..., Z 1000...	NaHj 400	PZ 1000KD20	NaHj 400PZT	—	—	VNaHj 400	—
Iwasaki	NH	E40	4.60	Z 400..., Z 1000...	NaHj 400	PZ 1000KD20	NaHj 400PZT	—	—	VNaHj 400	—
Iwasaki	NHT	E40	4.60	Z 400..., Z 1000...	NaHj 400	PZ 1000KD20	NaHj 400PZT	—	—	VNaHj 400	—
Narva	NA	E40	4.45	Z 400..., Z 1000...	NaHj 400	PZ 1000KD20	NaHj 400PZT	—	—	VNaHj 400	—
Narva	NA...D	E40	4.45	Z 400..., Z 1000...	NaHj 400	PZ 1000KD20	NaHj 400PZT	—	—	VNaHj 400	—
Narva	NA...S	E40	4.45	Z 400..., Z 1000...	NaHj 400	PZ 1000KD20	NaHj 400PZT	—	—	VNaHj 400	—
Osram	NAVE	E40	4.45	Z 400..., Z 1000...	NaHj 400	PZ 1000KD20	NaHj 400PZT	—	—	VNaHj 400	—
Osram	NAVE...4Y	E40	4.45	Z 400..., Z 1000...	NaHj 400	PZ 1000KD20	NaHj 400PZT	—	—	VNaHj 400	—
Osram	NAVE...Super 4Y	E40	4.40	Z 400..., Z 1000...	NaHj 400	PZ 1000KD20	NaHj 400PZT	—	—	VNaHj 400	—
Osram	NAV-T	E40	4.40	Z 400..., Z 1000...	NaHj 400	PZ 1000KD20	NaHj 400PZT	—	—	VNaHj 400	—
Osram	NAV-T...4Y	E40	4.40	Z 400..., Z 1000...	NaHj 400	PZ 1000KD20	NaHj 400PZT	—	—	VNaHj 400	—
Osram	NAV-T...Super 4Y	E40	4.40	Z 400..., Z 1000...	NaHj 400	PZ 1000KD20	NaHj 400PZT	—	—	VNaHj 400	—
Osram	NAV-TS	RX7s	4.40	Z 400..., Z 1000...	NaHj 400	PZ 1000KD20	NaHj 400PZT	HZ 600K	NaHj 400	VNaHj 400	—
Osram	Plantastar	E40	4.40	Z 400..., Z 1000...	NaHj 400	PZ 1000KD20	NaHj 400PZT	—	—	VNaHj 400	—
Philips	SON...Hg free	E40	4.50	Z 400..., Z 1000...	NaHj 400	PZ 1000KD20	NaHj 400PZT	—	—	VNaHj 400	—
Philips	SON...Plus	E40	4.50	Z 400..., Z 1000...	NaHj 400	PZ 1000KD20	NaHj 400PZT	—	—	VNaHj 400	—
Philips	SON...Pro	E40	4.45	Z 400..., Z 1000...	NaHj 400	PZ 1000KD20	NaHj 400PZT	—	—	VNaHj 400	—
Philips	SON...Comfort Pro	E40	4.60	Z 400..., Z 1000...	NaHj 400	PZ 1000KD20	NaHj 400PZT	—	—	VNaHj 400	—
Philips	SON-T...Agro	E40	4.13	Z 400..., Z 1000...	NaHj 400	PZ 1000KD20	NaHj 400PZT	—	—	VNaHj 400	—
Philips	SON-T...Green Power	E40	4.23	Z 400..., Z 1000...	NaHj 400	PZ 1000KD20	NaHj 400PZT	—	—	VNaHj 400	—
Philips	SON-T...Hg free	E40	4.60	Z 400..., Z 1000...	NaHj 400	PZ 1000KD20	NaHj 400PZT	—	—	VNaHj 400	—
Philips	SON-T...Plus	E40	4.50	Z 400..., Z 1000...	NaHj 400	PZ 1000KD20	NaHj 400PZT	—	—	VNaHj 400	—
Philips	SON-T...Pro	E40	4.60	Z 400..., Z 1000...	NaHj 400	PZ 1000KD20	NaHj 400PZT	—	—	VNaHj 400	—
Philips	SON-T...Comfort Pro	E40	4.45	Z 400..., Z 1000...	NaHj 400	PZ 1000KD20	NaHj 400PZT	—	—	VNaHj 400	—
Radium	RNPE	E40	4.60	Z 400..., Z 1000...	NaHj 400	PZ 1000KD20	NaHj 400PZT	—	—	VNaHj 400	—
Radium	RNP-T	E40	4.60	Z 400..., Z 1000...	NaHj 400	PZ 1000KD20	NaHj 400PZT	—	—	VNaHj 400	—
Sylvania	SHP	E40	4.60	Z 400..., Z 1000...	NaHj 400	PZ 1000KD20	NaHj 400PZT	—	—	VNaHj 400	—
Sylvania	SHP-S	E40	4.50	Z 400..., Z 1000...	NaHj 400	PZ 1000KD20	NaHj 400PZT	—	—	VNaHj 400	—
Sylvania	SHP-TS	E40	4.50	Z 400..., Z 1000...	NaHj 400	PZ 1000KD20	NaHj 400PZT	—	—	VNaHj 400	—
Sylvania	SHP-TS...Gro-Lux	E40	4.00	Z 400..., Z 1000...	NaHj 400	PZ 1000KD20	NaHj 400PZT	—	—	VNaHj 400	—

Lamp Table for Discharge Lamps

High-pressure sodium lamps (HS lamps)

Manufacturer	Designation	Base	Lamp current	Superimposed ignition system		Pulse ignition system		Instant restrike ignition system		Control gear unit	EB
				Ignitor	Ballast	Ignitor	Ballast	Ignitor	Ballast		
Lamp output 600 W											
Aura	ST 600 W	E40	6.20	Z 1000...	NaHj 600	PZ 1000KD20	NaHj 600PZT	—	—	VNaHj 600	—
Aura	SE 600 W	E40	6.20	Z 1000...	NaHj 600	PZ 1000KD20	NaHj 600PZT	—	—	VNaHj 600	—
GE	IU...PSL	E40	6.00	Z 750...	NaH 600	PZ 1000KD20	NaH 600PZT	—	—	VNaH 600	—
GE	IU...XO	E40	6.00	Z 750...	NaH 600	PZ 1000KD20	NaH 600PZT	—	—	VNaH 600	—
GE	IU 400V/600W PSL	E40	3.60	Z 1000/400V	NaH 600/400V	PZ 1000/400V A5	NaH 600PZT/400V	—	—	—	—
Narva	NA	E40	6.20	Z 750...	NaH 600	PZ 1000KD20	NaH 600PZT	—	—	VNaH 600	—
Narva	NA...S	E40	6.20	Z 750...	NaH 600	PZ 1000KD20	NaH 600PZT	—	—	VNaH 600	—
Osram	NAV-T...Super 4Y	E40	6.20	Z 750...	NaH 600	PZ 1000KD20	NaH 600PZT	—	—	VNaH 600	—
Osram	Plantastar 600	E40	6.20	Z 750...	NaH 600	PZ 1000KD20	NaH 600PZT	—	—	VNaH 600	—
Philips	SON-T...Plus	E40	5.80	Z 750...	NaH 600	PZ 1000KD20	NaH 600PZT	—	—	VNaH 600	—
Philips	SON-T... Green Power	E40	6.30	Z 750...	NaH 600	PZ 1000KD20	NaH 600PZT	—	—	VNaH 600	—
Philips	SON-T 600W/400V Green Power	E40	3.62	Z 1000/400V	NaH 600/400V	PZ 1000/400V A5	NaH 600PZT/400V	—	—	—	—
Philips	SON-T 600W EL 400V Green Power*	E40	2.93 -2.24	—	—	—	—	—	—	—	—
Radium	RNP-T	E40	6.20	Z 750...	NaH 600	PZ 1000KD20	NaH 600PZT	—	—	VNaH 600	—
Sylvania	SHP-TS	E40	5.90	Z 750...	NaH 600	PZ 1000KD20	NaH 600PZT	—	—	VNaH 600	—
Sylvania	SHP-TS...GroLux	E40	5.50	Z 750...	NaH 600	PZ 1000KD20	NaH 600PZT	—	—	VNaH 600	—
Lamp output 750 W											
GE	IU...PSL	E40	7.00	Z 750...	NaH 750	PZ 1000KD20	NaH 750/600PZT	—	—	—	—
GE	IU 400V/750W PSL	E40	4.40	Z 1000/400V	NaH 750/400V	PZ 1000/400V A5	NaHj 750PZT	—	—	—	—
Lamp output 1000 W											
Aura	ST 1000 W	E40	10.60	Z 1000...	NaHj 1000	PZ 1000KD20	—	—	—	—	—
Aura	SE 1000 W	E40	10.30	Z 1000...	NaHj 1000	PZ 1000KD20	—	—	—	—	—
GE	IU...T	E40	10.60	Z 1000...	NaH 1000, NaHJD 1000	PZ 1000KD20	—	—	—	—	—
GE	IU...D	E40	10.30	Z 1000...	NaH 1000, NaHJD 1000	PZ 1000KD20	—	—	—	—	—
GE	IU...TD	RX7s	10.30	Z 1000...	NaH 1000, NaHJD 1000	PZ 1000KD20	—	—	—	—	—
Iwasaki	NH	E40	10.30	Z 1000...	NaH 1000, NaHJD 1000	PZ 1000KD20	—	—	—	—	—
Iwasaki	NHT	E40	10.30	Z 1000...	NaH 1000, NaHJD 1000	PZ 1000KD20	—	—	—	—	—
Narva	NA	E40	10.60	Z 1000...	NaH 1000, NaHJD 1000	PZ 1000KD20	—	—	—	—	—
Narva	NA...D	E40	10.60	Z 1000...	NaH 1000, NaHJD 1000	PZ 1000KD20	—	—	—	—	—
Narva	NAT-VEG 1000/400V	E40	5.70	Z 1000/400V, Z 2000/400V	—	PZ 1000/400V A5	—	—	—	—	—
Osram	NAVE	E40	10.30	Z 1000...	NaH 1000, NaHJD 1000	PZ 1000KD20	—	—	—	—	—
Osram	NAV-T	E40	10.30	Z 1000...	NaH 1000, NaHJD 1000	PZ 1000KD20	—	—	—	—	—
Philips	SON...Pro	E40	10.30	Z 1000...	NaH 1000, NaHJD 1000	PZ 1000KD20	—	—	—	—	—
Philips	SON-T...Pro	E40	10.60	Z 1000...	NaH 1000, NaHJD 1000	PZ 1000KD20	—	—	—	—	—
Philips	SON-T 1000W EL 400V Green Power**	Wire	4-3.17	—	—	—	—	—	—	—	—
Radium	RNPE	E40	10.30	Z 1000...	NaH 1000, NaHJD 1000	PZ 1000KD20	—	—	—	—	—
Radium	RNP-T	E40	10.30	Z 1000...	NaH 1000, NaHJD 1000	PZ 1000KD20	—	—	—	—	—
Sylvania	SHP-T	E40	10.60	Z 1000...	NaH 1000, NaHJD 1000	PZ 1000KD20	—	—	—	—	—
Sylvania	SHP-T...SBY	E40	10.60	Z 1000...	NaH 1000, NaHJD 1000	PZ 1000KD20	—	—	—	—	—

* Voltage range 210–275 V

** Voltage range 250–315 V

Lamp Table for Discharge Lamps

Metal halide lamps (HI lamps)

Manufacturer	Designation	Base	Lamp current	Superimposed ignition system		Pulse ignition system		Instant restrike ignition system		Control gear unit	EB
				Ignitor	Ballast	Ignitor	Ballast	Ignitor	Ballast		
Lamp output 70 W											
BLV	HIE	E27	0.90	Z 250..., Z 400...	NaHj 70	PZ 1000KD20	NaHj 70PZT	—	—	VNaHj 70	EHXc 70
BLV	HIE-P	E27	0.90	Z 250..., Z 400...	NaHj 70	PZ 1000KD20	NaHj 70PZT	—	—	VNaHj 70	EHXc 70
BLV	HIT	G12	0.90	Z 250..., Z 400...	NaHj 70	PZ 1000KD20	NaHj 70PZT	—	—	VNaHj 70	EHXc 70
BLV	HIT-DE	RX7s	0.90	Z 250..., Z 400...	NaHj 70	PZ 1000KD20	NaHj 70PZT	—	—	VNaHj 70	EHXc 70
GE	ARC	G12	0.95	Z 250..., Z 400...	NaHj 70	PZ 1000KD20	NaHj 70PZT	—	—	VNaHj 70	EHXc 70
GE	ARC	Rx7s	0.95	Z 250..., Z 400...	NaHj 70	PZ 1000KD20	NaHj 70PZT	HZ 600K	NaHj 70	VNaHj 70	EHXc 70
Iwasaki	M	E27	1.00	Z 250..., Z 400...	NaHj 70	PZ 1000KD20	NaHj 70PZT	—	—	VNaHj 70	EHXc 70
Iwasaki	MT	E27	1.00	Z 70...	NaHj 70	PZ 1000KD20	NaHj 70PZT	—	—	VNaHj 70	EHXc 70
Iwasaki	MT	G8.5	1.00	Z 250..., Z 400...	NaHj 70	PZ 1000KD20	NaHj 70PZT	—	—	VNaHj 70	EHXc 70
Iwasaki	MT	G12	1.00	Z 250..., Z 400...	NaHj 70	PZ 1000KD20	NaHj 70PZT	—	—	VNaHj 70	EHXc 70
Narva	NC...	E27; G12	0.90	Z 250..., Z 400...	NaHj 70	PZ 1000KD20	NaHj 70PZT	—	—	VNaHj 70	EHXc 70
Narva	NC...	RX7s	0.90	Z 250..., Z 400...	NaHj 70	PZ 1000KD20	NaHj 70PZT	HZ 600K	NaHj 70	VNaHj 70	EHXc 70
Osram	HQIE	E27	0.95–1.00	Z 250..., Z 400...	NaHj 70	PZ 1000KD20	NaHj 70PZT	—	—	VNaHj 70	EHXc 70
Osram	HQHT	G12	1.00	Z 250..., Z 400...	NaHj 70	PZ 1000KD20	NaHj 70PZT	—	—	VNaHj 70	EHXc 70
Osram	HQHTS	RX7s	1.00	Z 250..., Z 400...	NaHj 70	PZ 1000KD20	NaHj 70PZT	HZ 600K	NaHj 70	VNaHj 70	EHXc 70
Philips	MHN-TD	RX7s	1.00	Z 250..., Z 400...	NaHj 70	PZ 1000KD20	NaHj 70PZT	HZ 600K	NaHj 70	VNaHj 70	EHXc 70
Philips	MHW-TD	RX7s	1.00	Z 250..., Z 400...	NaHj 70	PZ 1000KD20	NaHj 70PZT	HZ 600K	NaHj 70	VNaHj 70	EHXc 70
Radium	HRI-E	E27	0.95	Z 250..., Z 400...	NaHj 70	PZ 1000KD20	NaHj 70PZT	—	—	VNaHj 70	EHXc 70
Radium	HRI-T	G12	1.00	Z 250..., Z 400...	NaHj 70	PZ 1000KD20	NaHj 70PZT	—	—	VNaHj 70	EHXc 70
Radium	HRI-TS	RX7s	1.00	Z 250..., Z 400...	NaHj 70	PZ 1000KD20	NaHj 70PZT	HZ 600K	NaHj 70	VNaHj 70	EHXc 70
Sylvania	HSI-MP	E27	1.00	Z 250..., Z 400...	NaHj 70	PZ 1000KD20	NaHj 70PZT	—	—	VNaHj 70	EHXc 70
Sylvania	HSI-T	G12	0.95	Z 250..., Z 400...	NaHj 70	PZ 1000KD20	NaHj 70PZT	—	—	VNaHj 70	EHXc 70
Sylvania	HSI-TD	RX7s	0.98	Z 250..., Z 400...	NaHj 70	PZ 1000KD20	NaHj 70PZT	HZ 600K	NaHj 70	VNaHj 70	EHXc 70
Venture	HIE	E27	0.90	Z 250..., Z 400...	NaHj 70	PZ 1000KD20	NaHj 70PZT	—	—	VNaHj 70	EHXc 70
Venture	HIE-P	E27	0.90	Z 250..., Z 400...	NaHj 70	PZ 1000KD20	NaHj 70PZT	—	—	VNaHj 70	EHXc 70
Venture	HIT	E27	0.90	Z 250..., Z 400...	NaHj 70	PZ 1000KD20	NaHj 70PZT	—	—	VNaHj 70	EHXc 70
Venture	HIT	G12	0.90	Z 250..., Z 400...	NaHj 70	PZ 1000KD20	NaHj 70PZT	—	—	VNaHj 70	EHXc 70
Venture	MH-DE	RX7s	1.00	Z 250..., Z 400...	NaHj 70	PZ 1000KD20	NaHj 70PZT	—	—	VNaHj 70	EHXc 70
Lamp output 100 W											
BLV	HIE	E27	1.20	Z 250..., Z 400...	NaHj 100	PZ 1000KD20	NaHj 100PZT	—	—	VNaHj 100	—
BLV	HIE-P	E27	1.20	Z 250..., Z 400...	NaHj 100	PZ 1000KD20	NaHj 100PZT	—	—	VNaHj 100	—
Narva	NC...	E27; E40	1.10	Z 250..., Z 400...	NaHj 100	PZ 1000KD20	NaHj 100PZT	—	—	VNaHj 100	—
Osram	HQIE	E27	1.10	Z 250..., Z 400...	NaHj 100	PZ 1000KD20	NaHj 100PZT	—	—	VNaHj 100	—
Radium	HRI-E	E27	1.10	Z 250..., Z 400...	NaHj 100	PZ 1000KD20	NaHj 100PZT	—	—	VNaHj 100	—
Sylvania	HSI-MP	E27	1.15	Z 250..., Z 400...	NaHj 100	PZ 1000KD20	NaHj 100PZT	—	—	VNaHj 100	—
Venture	HIE	E27	1.10	Z 250..., Z 400...	NaHj 100	PZ 1000KD20	NaHj 100PZT	—	—	VNaHj 100	—
Venture	HIE-P	E27; E40	1.10	Z 250..., Z 400...	NaHj 100	PZ 1000KD20	NaHj 100PZT	—	—	VNaHj 100	—
Venture	HIT	E27; E40	1.10	Z 250..., Z 400...	NaHj 100	PZ 1000KD20	NaHj 100PZT	—	—	VNaHj 100	—
Lamp output 150 W											
BLV	HIE	E27	1.80	Z 250..., Z 400...	NaHj 150	PZ 1000KD20	NaHj 150PZT	—	—	VNaHj 150	EHXc 150
BLV	HIE-P	E27	1.80	Z 250..., Z 400...	NaHj 150	PZ 1000KD20	NaHj 150PZT	—	—	VNaHj 150	EHXc 150
BLV	HIT	G12; E27; E40	1.80	Z 250..., Z 400...	NaHj 150	PZ 1000KD20	NaHj 150PZT	—	—	VNaHj 150	EHXc 150
BLV	HIT-DE	RX7s-24	1.80	Z 250..., Z 400...	NaHj 150	PZ 1000KD20	NaHj 150PZT	HZ 1000K	NaHj 150	VNaHj 150	EHXc 150
GE	ARC	G12	1.80	Z 250..., Z 400...	NaHj 150	PZ 1000KD20	NaHj 150PZT	—	—	VNaHj 150	EHXc 150
GE	ARC	RX7s-24	1.80	Z 250..., Z 400...	NaHj 150	PZ 1000KD20	NaHj 150PZT	HZ 1000K	NaHj 150	VNaHj 150	EHXc 150
Iwasaki	M	E27	1.90	Z 250..., Z 400...	NaHj 150	PZ 1000KD20	NaHj 150PZT	—	—	VNaHj 150	EHXc 150
Iwasaki	MT	E27	1.90	Z 250..., Z 400...	NaHj 150	PZ 1000KD20	NaHj 150PZT	—	—	VNaHj 150	EHXc 150
Iwasaki	MT	G12	1.90	Z 250..., Z 400...	NaHj 150	PZ 1000KD20	NaHj 150PZT	—	—	VNaHj 150	EHXc 150
Iwasaki	MTD	RX7s	1.90	Z 250..., Z 400...	NaHj 150	PZ 1000KD20	NaHj 150PZT	HZ 1000K	NaHj 150	VNaHj 150	EHXc 150
Narva	NC...	E27; E40; G12	1.80	Z 250..., Z 400...	NaHj 150	PZ 1000KD20	NaHj 150PZT	—	—	VNaHj 150	EHXc 150
Narva	NC...	RX7s	1.80	Z 250..., Z 400...	NaHj 150	PZ 1000KD20	NaHj 150PZT	HZ 1000K	NaHj 150	VNaHj 150	EHXc 150
Osram	HQIE	E27	1.80	Z 250..., Z 400...	NaHj 150	PZ 1000KD20	NaHj 150PZT	—	—	VNaHj 150	EHXc 150
Osram	HQIR	connector	1.80	Z 250..., Z 400...	NaHj 150	PZ 1000KD20	NaHj 150PZT	—	—	VNaHj 150	—
Osram	HQHT	G12	1.80	Z 250..., Z 400...	NaHj 150	PZ 1000KD20	NaHj 150PZT	—	—	VNaHj 150	EHXc 150
Osram	HQHTS	RX7s-24	1.80	Z 250..., Z 400...	NaHj 150	PZ 1000KD20	NaHj 150PZT	HZ 1000K	NaHj 150	VNaHj 150	EHXc 150
Philips	MHN-TD	RX7s	1.80	Z 250..., Z 400...	NaHj 150	PZ 1000KD20	NaHj 150PZT	HZ 1000K	NaHj 150	VNaHj 150	EHXc 150
Philips	MHW-TD	RX7s	1.80	Z 250..., Z 400...	NaHj 150	PZ 1000KD20	NaHj 150PZT	HZ 1000K	NaHj 150	VNaHj 150	EHXc 150
Radium	HRI-E	E27	1.80	Z 250..., Z 400...	NaHj 150	PZ 1000KD20	NaHj 150PZT	—	—	VNaHj 150	EHXc 150
Radium	HRI-T	G12	1.80	Z 250..., Z 400...	NaHj 150	PZ 1000KD20	NaHj 150PZT	—	—	VNaHj 150	EHXc 150
Radium	HRI-TS	RX7s	1.80	Z 250..., Z 400...	NaHj 150	PZ 1000KD20	NaHj 150PZT	HZ 1000K	NaHj 150	VNaHj 150	EHXc 150

Lamp Table for Discharge Lamps

Metal halide lamps (HI lamps)

Manu- facturer	Designation	Base	Lamp current	Superimposed ignition system		Pulse ignition system		Instant restrike ignition system		Control gear unit	EB
				Ignitor	Ballast	Ignitor	Ballast	Ignitor	Ballast		
Lamp output 150 W											
Sylvania	HSI-MP	E27	1.80	Z 250..., Z 400...	NaHj 150	PZ 1000KD20	NaHj 150PZT	—	—	VNaHj 150	EHXc 150
Sylvania	HSI-T	G12	1.80	Z 250..., Z 400...	NaHj 150	PZ 1000KD20	NaHj 150PZT	—	—	VNaHj 150	EHXc 150
Sylvania	HSI-TD	RX7s	1.80	Z 250..., Z 400...	NaHj 150	PZ 1000KD20	NaHj 150PZT	HZ 1000K	NaHj 150	VNaHj 150	EHXc 150
Venture	HIE	E27	1.80	Z 250..., Z 400...	NaHj 150	PZ 1000KD20	NaHj 150PZT	—	—	VNaHj 150	EHXc 150
Venture	HIPE	E27; E40	1.80	Z 250..., Z 400...	NaHj 150	PZ 1000KD20	NaHj 150PZT	—	—	VNaHj 150	EHXc 150
Venture	HIT	E27; E40	1.80	Z 250..., Z 400...	NaHj 150	PZ 1000KD20	NaHj 150PZT	—	—	VNaHj 150	EHXc 150
Venture	HIT	G12	1.80	Z 250..., Z 400...	NaHj 150	PZ 1000KD20	NaHj 150PZT	—	—	VNaHj 150	EHXc 150
Venture	MH-DE	RX7s	1.80	Z 250..., Z 400...	NaHj 150	PZ 1000KD20	NaHj 150PZT	HZ 1000K	NaHj 150	VNaHj 150	EHXc 150
Lamp output 250 W											
BLV	HIE	E40	3.00	Z 250..., Z 400...	NaHj 250	PZ 1000KD20	NaHj 250PZT	—	—	VNaHj 250	—
BLV	HIT	E40	3.00	Z 250..., Z 400...	NaHj 250	PZ 1000KD20	NaHj 250PZT	—	—	VNaHj 250	—
BLV	HIT-DE	Fc2	3.00	Z 250..., Z 400...	NaHj 250	PZ 1000KD20	NaHj 250PZT	HZ 1000K	NaHj 250	VNaHj 250	—
GE	ARC250/T	E40	2.75	Z 250..., Z 400...	NaHj 250	PZ 1000KD20	NaHj 250PZT	—	—	VNaHj 250	—
GE	ARC250/TD	Fc2	3.00	Z 250..., Z 400...	NaHj 250	PZ 1000KD20	NaHj 250PZT	HZ 1000K	NaHj 250	VNaHj 250	—
Narva	NC...	E40	2.15	Z 250..., Z 400...	NaHj 250	PZ 1000KD20	NaHj 250PZT	—	—	VNaHj 250	—
Narva	NC...P	E40	2.15	—	—	PZI 1000/1	Q 250	—	—	—	—
Osram	HQIE	E40	3.00	Z 250..., Z 400...	NaHj 250	PZ 1000KD20	NaHj 250PZT	—	—	VNaHj 250	—
Osram	HQIE/P	E40	3.00	Z 250..., Z 400...	NaHj 250	PZ 1000KD20	NaHj 250PZT	—	—	VNaHj 250	—
Osram	HQIT	E40	3.00	Z 250..., Z 400...	NaHj 250	PZ 1000KD20	NaHj 250PZT	—	—	VNaHj 250	—
Osram	HQITS	Fc2	3.00	Z 250..., Z 400...	NaHj 250	PZ 1000KD20	NaHj 250PZT	HZ 1000K	NaHj 250	VNaHj 250	—
Philips	HPI Plus	E40	2.20	Z 250..., Z 400...	—	PZI 1000/1	Q 250	—	—	—	—
Philips	HPI-T	E40	2.15	Z 250..., Z 400...	—	PZI 1000/1	Q 250	—	—	—	—
Philips	MHN-TD	Fc2	3.00	Z 250..., Z 400...	NaHj 250	PZ 1000KD20	NaHj 250PZT	—	—	VNaHj 250	—
Radium	HRI-E	E40	3.00	Z 250..., Z 400...	NaHj 250	PZ 1000KD20	NaHj 250PZT	—	—	VNaHj 250	—
Radium	HRI-T	E40	3.00	Z 250..., Z 400...	NaHj 250	PZ 1000KD20	NaHj 250PZT	—	—	VNaHj 250	—
Radium	HRI-TS	Fc2	3.00	Z 250..., Z 400...	NaHj 250	PZ 1000KD20	NaHj 250PZT	HZ 1000K	NaHj 250	VNaHj 250	—
Sylvania	HSI-HX	E40	2.10	—	—	PZI 1000/1	Q 250	—	—	—	—
Sylvania	HSI-T	E40	3.00	Z 250..., Z 400...	NaHj 250	PZ 1000KD20	NaHj 250PZT	—	—	VNaHj 250	—
Sylvania	HSI-TD	Fc2	3.00	Z 250..., Z 400...	NaHj 250	PZ 1000KD20	NaHj 250PZT	HZ 1000K	NaHj 250	VNaHj 250	—
Sylvania	HSI-THX	E40	2.10	—	—	PZI 1000/1	Q 250	—	—	—	—
Sylvania	HSI-TSX	E40	2.90	Z 250..., Z 400...	NaHj 250	PZ 1000KD20	NaHj 250PZT	—	—	VNaHj 250	—
Sylvania	HSI-SX	E40	2.90	Z 250..., Z 400...	NaHj 250	PZ 1000KD20	NaHj 250PZT	—	—	VNaHj 250	—
Venture	HIE	E40	3.10	Z 250..., Z 400...	NaHj 250	PZ 1000KD20	NaHj 250PZT	—	—	VNaHj 250	—
Venture	HIPE	E40	3.10	Z 250..., Z 400...	NaHj 250	PZ 1000KD20	NaHj 250PZT	—	—	VNaHj 250	—
Venture	HIT	E40	3.10	Z 250..., Z 400...	NaHj 250	PZ 1000KD20	NaHj 250PZT	—	—	VNaHj 250	—
Venture	HIT...EURO	E40	2.10	—	—	PZI 1000/1	Q 250	—	—	—	—
Venture	MH-DE	Fc2	3.10	Z 250..., Z 400...	NaHj 250	PZ 1000KD20	NaHj 250PZT	HZ 1000K	NaHj 250	VNaHj 250	—
Lamp output 400 W											
BLV	HIE	E40	4.00	Z 400..., Z 1000...	NaHj 400	PZ 1000KD20	NaHj 400PZT	—	—	VNaHj 400	—
BLV	HIT	E40	4.00	Z 400..., Z 1000...	NaHj 400	PZ 1000KD20	NaHj 400PZT	—	—	VNaHj 400	—
GE	ARC400/T	E40	4.35	Z 400..., Z 1000...	NaHj 400	PZ 1000KD20	NaHj 400PZT	—	—	VNaHj 400	—
Narva	NC...	E40	3.25	Z 400..., Z 1000...	NaHj 400	PZ 1000KD20	NaHj 400PZT	—	—	VNaHj 400	—
Narva	NC...P	E40	3.25	—	—	PZI 1000/1	Q 400	—	—	—	—
Osram	HQIE	E40	3.50	Z 400..., Z 1000...	NaHj 400	PZ 1000KD20	NaHj 400PZT	—	—	VNaHj 400	—
Osram	HQIE/P	E40	3.50	Z 400..., Z 1000...	NaHj 400	PZ 1000KD20	NaHj 400PZT	—	—	VNaHj 400	—
Osram	HQIT	E40	3.60	Z 400..., Z 1000...	NaHj 400	PZ 1000KD20	NaHj 400PZT	—	—	VNaHj 400	—
Osram	HQITS	Fc2	3.60	Z 400..., Z 1000...	NaHj 400	PZ 1000KD20	NaHj 400PZT	HZ 1000K	NaHj 400	VNaHj 400	—
Philips	HPI-T	E40	3.40	—	—	PZI 1000/1	Q 400	—	—	—	—
Philips	MH-T	E40	3.40	Z 400..., Z 1000...	NaHj 400	PZ 1000KD20	NaHj 400PZT	—	—	VNaHj 400	—
Radium	HRI-BT	E40	4.00	Z 400..., Z 1000...	NaHj 400	PZ 1000KD20	NaHj 400PZT	—	—	VNaHj 400	—
Radium	HRI-E	E40	4.60	Z 400..., Z 1000...	NaHj 400	PZ 1000KD20	NaHj 400PZT	—	—	VNaHj 400	—
Radium	HRI-T	E40	4.60	Z 400..., Z 1000...	NaHj 400	PZ 1000KD20	NaHj 400PZT	—	—	VNaHj 400	—
Radium	HRI-TS	Fc2	4.10	Z 400..., Z 1000...	NaHj 400	PZ 1000KD20	NaHj 400PZT	HZ 1000K	NaHj 400	VNaHj 400	—
Sylvania	HSI-HX	E40	3.40	—	—	PZI 1000/1	Q 400	—	—	—	—
Sylvania	HSI-T	E40	4.00	Z 400..., Z 1000...	NaHj 400	PZ 1000KD20	NaHj 400PZT	—	—	VNaHj 400	—
Sylvania	HSI-THX	E40	3.40	—	—	PZI 1000/1	Q 400	—	—	—	—
Sylvania	HSI-TSX	E40	4.40	Z 400..., Z 1000...	NaHj 400	PZ 1000KD20	NaHj 400PZT	—	—	VNaHj 400	—
Sylvania	HSI-SX	E40	4.40	Z 400..., Z 1000...	NaHj 400	PZ 1000KD20	NaHj 400PZT	—	—	VNaHj 400	—
Venture	HIE	E40	3.20	Z 400..., Z 1000...	NaHj 400	PZ 1000KD20	NaHj 400PZT	—	—	VNaHj 400	—
Venture	HIPE	E40	3.20	Z 400..., Z 1000...	NaHj 400	PZ 1000KD20	NaHj 400PZT	—	—	VNaHj 400	—

Lamp Table for Discharge Lamps

Metal halide lamps (HI lamps)

Manu- facturer	Designation	Base	Lamp current	Superimposed ignition system		Pulse ignition system		Instant restrike ignition system		Control gear unit	EB
				Ignitor	Ballast	Ignitor	Ballast	Ignitor	Ballast		
Lamp output 400 W											
Venture	HIT	E40	3.20	Z 400..., Z 1000...	NaHJ 400	PZ 1000KD20	NaHJ 400PZT	—	—	VNaHJ 400	—
Venture	HIT...EURO	E40	3.20	—	—	PZI 1000/1	Q 400	—	—	—	—
Lamp output 600 W											
Osram	HQITM	G22	6.10	Z 1000	NaH 600	PZ 1000KD20	NaH 600PZT	—	—	VNaH 600	—
Radium	HRI-TM	G22	6.10	Z 1000	NaH 600	PZ 1000KD20	NaH 600PZT	—	—	VNaH 600	—
Lamp output 1000 W											
BLV	HIT	E40	9.50	Z 1000..., Z 2000	NaHJ 1000	PZ 1000KD20	—	—	—	—	—
GE	SPL 1000	E40	9.50	Z 1000..., Z 2000	NaHJ 1000	PZ 1000KD20	—	—	—	—	—
Narva	NC...	E40	8.25	Z 1000..., Z 2000	NaHJ 1000	PZ 1000KD20	—	—	—	—	—
Narva	NC...P	E40	8.25	—	—	PZI 1000/1	Q 1000	—	—	—	—
Narva	NCT.../400V	E40	4.80	Z 1000/400V; Z 2000/400V	NaHJ 1000	—	—	—	—	—	—
Osram	HQITM	G22	9.50	Z 1000	NaHJ 1000	PZ 1000KD20	—	—	—	—	—
Osram	HQIE	E40	9.50	Z 1000..., Z 2000	NaHJ 1000	PZ 1000KD20	—	—	—	—	—
Osram	HQIT	E40	9.50	Z 1000..., Z 2000	NaHJ 1000	PZ 1000KD20	—	—	—	—	—
Osram	HQITS	cables	9.60	Z 1000..., Z 2000	NaHJ 1000	PZ 1000KD20	—	HZ 1000K	NaHJ 1000	—	—
Philips	HPI-T	E40	8.25	—	—	PZI 1000/1	Q 1000	—	—	—	—
Philips	MHN-LA	cables	9.30	Z 1000..., Z 2000	NaHJ 1000	PZ 1000KD20	—	HZ 1000K	NaHJ 1000	—	—
Radium	HRI-T	E40	9.50	Z 1000..., Z 2000	NaHJ 1000	PZ 1000KD20	—	—	—	—	—
Radium	HRI-TM	G22	9.50	Z 1000	NaHJ 1000	PZ 1000KD20	—	—	—	—	—
Radium	HRI-TS	cables	9.60	Z 1000..., Z 2000	NaHJ 1000	PZ 1000KD20	—	HZ 1000K	NaHJ 1000	—	—
Sylvania	HSI-THX	E40	8.25	—	—	PZI 1000/1	Q 1000	—	—	—	—
Venture	HIT	E40	9.15	Z 1000..., Z 2000	NaHJ 1000	PZ 1000KD20	—	—	—	—	—
Venture	MBIL	RX7s	4.40	Z 2000/400V	—	—	—	HZ 2000K/ 400V	—	—	—
Lamp output 2000 W											
GE	SPL 2000/T	E40	10.30	Z 2000/400V	JD 2000	—	—	—	—	—	—
Osram	HQIT/D	E40	10.30	Z 2000/400V	JD 2000	—	—	—	—	—	—
Osram	HQIT... /380V	E40	8.80	—	—	—	QJ 2000	—	—	—	—
Osram	HQITS	cables	11.30	Z 2000/400V	JD 2000	—	—	HZ 2000K/ 400 V	JD 2000	—	—
Osram	HQITS	cables	12.2	Z 2000/400V	JD 2000II/ 12.2	—	—	—	—	—	—
Philips	HPI-T 220V	E40	16.50	—	—	PZI 1000/1	JD 2000 I	—	—	—	—
Philips	HPI-T 380V	E40	9.10	—	—	—	QJ 2000	—	—	—	—
Philips	MHN-LA	cables	9.6–10.3	Z 2000/400V	JD 2000	—	—	HZ 2000K/ 400 V	JD 2000	—	—
Philips	MHN-SA	X830R	11.30	Z 2000/400V	JD 2000	—	—	HZ 2000K/ 400 V	JD 2000	—	—
Philips	MHN-SB 400V	cables	11.30	Z 2000/400V	JD 2000	—	—	HZ 2000K/ 400 V	—	—	—
Radium	HRI-T 230V	E40	16.50 (2x8.25)	—	—	PZI 1000/1	JD 2000 I	—	—	—	—
Radium	HRI-T/D	E40	10.30	Z 2000/400V	JD 2000	—	—	—	—	—	—
Radium	HRI-TS	E40	10.30	Z 2000/400V	JD 2000	—	—	—	—	—	—
Radium	HRI-TS	cables	11.30	Z 2000/400V	JD 2000	—	—	HZ 2000K/ 400 V*	JD 2000	—	—
Sylvania	HSI-T	E40	9.00	Z 2000/400V	JD 2000	—	—	—	—	—	—
Sylvania	HSI-TD	cables	11.30	Z 2000/400V	JD 2000	—	—	HZ 2000K/ 400	JD 2000	—	—
Venture	MH	cables	10.30	Z 2000	JD 2000	—	—	—	—	—	—
Venture	MBIL	RX7s	10.30	Z 2000	JD 2000	—	—	—	—	—	—
Lamp output 3500 W											
Radium	HRI-T	E40	18.00	Z 3500/400V	JD 3500	—	—	—	—	—	—
Radium	HRI-TS	cables	18.00	Z 3500/400V	JD 3500	—	—	—	—	—	—

* Not suitable HRI-TS 2000W/N/L; HQI-TS 2000W/N/L

1

2

3

4

5

6

7

8

9

10

Lamp Table for Discharge Lamps

Ceramic discharge tube lamps (C-HI)

Manufacturer	Designation	Base	Lamp current	Superimposed ignition system		Pulse ignition system		Instant restrike ignition system		Control gear unit	EB
				Ignitor*	Ballast	Ignitor	Ballast	Ignitor	Ballast		
Lamp output 20 W											
GE	CMH20MR16	GX10	0.21	—	—	—	—	—	—	—	—
GE	CMH20PAR	E27	0.23	—	—	—	—	—	—	—	—
GE	CMH20T	G12	0.23	—	—	—	—	—	—	—	—
GE	CMH20T	GU6.5	0.21	—	—	—	—	—	—	—	—
GE	CMH20TC	G8.5	0.23	—	—	—	—	—	—	—	—
GE	CMH20TC	G12	0.23	—	—	—	—	—	—	—	—
Osram	HCI-PAR	E27	0.22	—	—	—	—	—	—	—	—
Osram	HCI-R111	GX8.5	0.22	—	—	—	—	—	—	—	—
Osram	HCI-TF	GU6.5	0.22	—	—	—	—	—	—	—	—
Osram	HCI-TC	G8.5	0.22	—	—	—	—	—	—	—	—
Philips	CDM-TM	PGJ5	0.22	—	—	—	—	—	—	—	—
Philips	CDM-R	GX10	0.22	—	—	—	—	—	—	—	—
Radium	RCC-TC	G8.5	0.22	—	—	—	—	—	—	—	—
Lamp output 35 W											
Aura	TT 35 W	E27	0.45	Z 250..., Z 400...	NaHj 35	PZ 1000KD20	NaHj 35PZT	—	—	VNaHj 35	—
BLV	C-HIT	G12	0.50	Z 250..., Z 400...	NaHj 35	PZ 1000KD20	NaHj 35PZT	—	—	VNaHj 35	EHXc 35
GE	CMH35PAR	E27	0.50	Z 250..., Z 400...	NaHj 35	PZ 1000KD20	NaHj 35PZT	—	—	VNaHj 35	EHXc 35
GE	CMH35T	G12	0.50	Z 250..., Z 400...	NaHj 35	PZ 1000KD20	NaHj 35PZT	—	—	VNaHj 35	EHXc 35
GE	CMH35TC	G8.5	0.50	Z 250..., Z 400...	NaHj 35	PZ 1000KD20	NaHj 35PZT	—	—	VNaHj 35	EHXc 35
Osram	HCI-E/P	E27	0.50	Z 250..., Z 400...	NaHj 35	PZ 1000KD20	NaHj 35PZT	—	—	VNaHj 35	EHXc 35
Osram	HCI-PAR	E27	0.50	Z 250..., Z 400...	NaHj 35	PZ 1000KD20	NaHj 35PZT	—	—	VNaHj 35	EHXc 35
Osram	HCI-R111	GX8.5	0.50	Z 250..., Z 400...	NaHj 35	PZ 1000KD20	NaHj 35PZT	—	—	VNaHj 35	EHXc 35
Osram	HCI-T	G12	0.50	Z 250..., Z 400...	NaHj 35	PZ 1000KD20	NaHj 35PZT	—	—	VNaHj 35	EHXc 35
Osram	HCI-TC	G8.5	0.50	Z 250..., Z 400...	NaHj 35	PZ 1000KD20	NaHj 35PZT	—	—	VNaHj 35	EHXc 35
Osram	HCI-TF	GU6.5	0.50	Z 250..., Z 400...	NaHj 35	PZ 1000KD20	NaHj 35PZT	—	—	VNaHj 35	EHXc 35
Panasonic	CPS 35 W	GU8.5	0.44	—	—	—	—	—	—	—	EHXc 35
Philips	CDM-R	E27	0.53	Z 250..., Z 400...	NaHj 35	PZ 1000KD20	NaHj 35PZT	—	—	VNaHj 35	EHXc 35
Philips	CDM-R111	GX8.5	0.53	Z 250..., Z 400...	NaHj 35	PZ 1000KD20	NaHj 35PZT	—	—	VNaHj 35	EHXc 35
Philips	CDM-T	G12	0.53	Z 250..., Z 400...	NaHj 35	PZ 1000KD20	NaHj 35PZT	—	—	VNaHj 35	EHXc 35
Philips	CDM-TC	G8.5	0.53	Z 250..., Z 400...	NaHj 35	PZ 1000KD20	NaHj 35PZT	—	—	VNaHj 35	EHXc 35
Philips	CDM-R	GX10	0.53	Z 250..., Z 400...	NaHj 35	PZ 1000KD20	NaHj 35PZT	—	—	—	EHXc 35G
Radium	RCC-PAR	E27	0.50	Z 250..., Z 400...	NaHj 35	PZ 1000KD20	NaHj 35PZT	—	—	VNaHj 35	EHXc 35
Radium	RCC-T	G12	0.50	Z 250..., Z 400...	NaHj 35	PZ 1000KD20	NaHj 35PZT	—	—	VNaHj 35	EHXc 35
Radium	RCC-TC	G8.5	0.50	Z 250..., Z 400...	NaHj 35	PZ 1000KD20	NaHj 35PZT	—	—	VNaHj 35	EHXc 35
Sylvania	CM-T	G12	0.53	Z 250..., Z 400...	NaHj 35	PZ 1000KD20	NaHj 35PZT	—	—	VNaHj 35	EHXc 35
Sylvania	CM-TC	G8.5	0.53	Z 250..., Z 400...	NaHj 35	PZ 1000KD20	NaHj 35PZT	—	—	VNaHj 35	EHXc 35
Venture	CMH35/T	G12	0.50	Z 250..., Z 400...	NaHj 35	PZ 1000KD20	NaHj 35PZT	—	—	VNaHj 35	EHXc 35
Venture	CMH35/TC	G8.5	0.50	Z 250..., Z 400...	NaHj 35	PZ 1000KD20	NaHj 35PZT	—	—	VNaHj 35	EHXc 35
Lamp output 50 W											
Aura	TT 50 W	E27	0.60	Z250..., Z400...	NaH 50	PZ1000KD20	NAH50PZT	—	—	VNaH 50	—
Philips	CDM-TC Elite	G8.5	0.59	Z 70...	NaH 50	—	—	—	—	VNaH 50	—
Philips	CDM-T Elite	G12	0.57	Z 70...	NaH 50	—	—	—	—	VNaH 50	—
Lamp output 70 W											
Aura	TT 70 W	E27	0.80	Z 250..., Z 400...	NaHj 70	PZ 1000KD20	NaHj 70PZT	—	—	VNaHj 70	—
BLV	C-HIT	G12	0.98	Z 250..., Z 400...	NaHj 70	PZ 1000KD20	NaHj 70PZT	—	—	VNaHj 70	EHXc 70
BLV	C-HIT-DE	RX7s	0.90	Z 250..., Z 400...	NaHj 70	PZ 1000KD20	NaHj 70PZT	—	—	VNaHj 70	EHXc 70
GE	CMH70E	E27	0.98	Z 250..., Z 400...	NaHj 70	PZ 1000KD20	NaHj 70PZT	—	—	VNaHj 70	EHXc 70
GE	CMH70PAR	E27	0.98	Z 250..., Z 400...	NaHj 70	PZ 1000KD20	NaHj 70PZT	—	—	VNaHj 70	EHXc 70
GE	CMH70T	G12	0.98	Z 250..., Z 400...	NaHj 70	PZ 1000KD20	NaHj 70PZT	—	—	VNaHj 70	EHXc 70
GE	CMH70TC	G8.5	0.98	Z 250..., Z 400...	NaHj 70	PZ 1000KD20	NaHj 70PZT	—	—	VNaHj 70	EHXc 70
GE	CMH70TD	Rx7s	0.98	Z 250..., Z 400...	NaHj 70	PZ 1000KD20	NaHj 70PZT	—	—	VNaHj 70	EHXc 70
GE	CMH70TT	E27	0.98	Z 70...	NaHj 70	PZ 1000KD20	NaHj 70PZT	—	—	VNaHj 70	EHXc 70
Osram	HCI-E/P	E27	0.98	Z 250..., Z 400...	NaHj 70	PZ 1000KD20	NaHj 70PZT	—	—	VNaHj 70	EHXc 70
Osram	HCI-PAR	E27	0.97	Z 250..., Z 400...	NaHj 70	PZ 1000KD20	NaHj 70PZT	—	—	VNaHj 70	EHXc 70
Osram	HCI-R111	GX8.5	0.98	Z 250..., Z 400...	NaHj 70	PZ 1000KD20	NaHj 70PZT	—	—	VNaHj 70	EHXc 70
Osram	HCI-T	G12	0.96	Z 250..., Z 400...	NaHj 70	PZ 1000KD20	NaHj 70PZT	—	—	VNaHj 70	EHXc 70
Osram	HCI-T/P	E27	0.98	Z 250..., Z 400...	NaHj 70	PZ 1000KD20	NaHj 70PZT	—	—	VNaHj 70	EHXc 70
Osram	HCI-TC	G8.5	0.96	Z 250..., Z 400...	NaHj 70	PZ 1000KD20	NaHj 70PZT	—	—	VNaHj 70	EHXc 70
Osram	HCI-TS	RX7s	0.95	Z 250..., Z 400...	NaHj 70	PZ 1000KD20	NaHj 70PZT	HZ 600K	NaHj 70	VNaHj 70	EHXc 70
Osram	HCI-TT	E27	0.92	Z 70...	NaHj 70	PZ 1000KD20	NaHj 70PZT	—	—	VNaHj 70	EHXc 70

Lamp Table for Discharge Lamps

Ceramic discharge tube lamps (C-HI)

Manu- facturer	Designation	Base	Lamp current	Superimposed ignition system		Pulse ignition system		Instant restrike ignition system		Control gear unit	EB
				Ignitor*	Ballast	Ignitor	Ballast	Ignitor	Ballast		
Lamp output 70 W											
Panasonic	CPS 70 W	GU8.5	0.86	—	—	—	—	—	—	—	EHXc 70
Philips	CDO-ET	E27	0.98	Z 70...	NaHj 70	PZ 1000KD20	NaHj 70PZT	—	—	VNaHj 70	EHXc 70
Philips	CDO-TT	E27	1.00	Z 70...	NaHj 70	PZ 1000KD20	NaHj 70PZT	—	—	VNaHj 70	—
Philips	CDM-R	E27	0.97	Z 250..., Z 400...	NaHj 70	PZ 1000KD20	NaHj 70PZT	—	—	VNaHj 70	EHXc 70
Philips	CDM-R 111	GX8.5	0.97	Z 250..., Z 400...	NaHj 70	PZ 1000KD20	NaHj 70PZT	—	—	VNaHj 70	EHXc 70
Philips	CDM-T	G12	0.98	Z 250..., Z 400...	NaHj 70	PZ 1000KD20	NaHj 70PZT	—	—	VNaHj 70	EHXc 70
Philips	CDM-TC	G8.5	0.98	Z 250..., Z 400...	NaHj 70	PZ 1000KD20	NaHj 70PZT	—	—	VNaHj 70	EHXc 70
Philips	CDM-TD	RX7s	0.97	Z 250..., Z 400...	NaHj 70	PZ 1000KD20	NaHj 70PZT	HZ 600K	NaHj 70	VNaHj 70	EHXc 70
Philips	CDM-TP	PG12-2	0.98	Z 250..., Z 400...	NaHj 70	PZ 1000KD20	NaHj 70PZT	—	—	VNaHj 70	EHXc 70
Radium	RCC-PAR	E27	0.98	Z 250..., Z 400...	NaHj 70	PZ 1000KD20	NaHj 70PZT	—	—	VNaHj 70	EHXc 70
Radium	RCC-T	G12	0.96	Z 250..., Z 400...	NaHj 70	PZ 1000KD20	NaHj 70PZT	—	—	VNaHj 70	EHXc 70
Radium	RCC-TC	G8.5	0.96	Z 250..., Z 400...	NaHj 70	PZ 1000KD20	NaHj 70PZT	—	—	VNaHj 70	EHXc 70
Radium	RCC-TS	RX7s	0.98	Z 250..., Z 400...	NaHj 70	PZ 1000KD20	NaHj 70PZT	HZ 600K	NaHj 70	VNaHj 70	EHXc 70
Sylvania	CMH-T	G12	0.98	Z 250..., Z 400...	NaHj 70	PZ 1000KD20	NaHj 70PZT	—	—	VNaHj 70	EHXc 70
Sylvania	CMH-TC	G8.5	0.98	Z 250..., Z 400...	NaHj 70	PZ 1000KD20	NaHj 70PZT	—	—	VNaHj 70	EHXc 70
Sylvania	CMH-TD	RX7s	0.98	Z 250..., Z 400...	NaHj 70	PZ 1000KD20	NaHj 70PZT	—	—	VNaHj 70	EHXc 70
Venture	CMH70/T	G12	0.98	Z 250..., Z 400...	NaHj 70	PZ 1000KD20	NaHj 70PZT	—	—	VNaHj 70	EHXc 70
Venture	CMH70/TC	G8.5	0.98	Z 250..., Z 400...	NaHj 70	PZ 1000KD20	NaHj 70PZT	—	—	VNaHj 70	EHXc 70
Venture	CMH70/TD	RX7s	0.98	Z 250..., Z 400...	NaHj 70	PZ 1000KD20	NaHj 70PZT	—	—	VNaHj 70	EHXc 70
Venture	CMH70/TT	E27	0.98	Z 70...	NaHj 70	PZ 1000KD20	NaHj 70PZT	—	—	VNaHj 70	EHXc 70
Lamp output 100 W											
Aura	TT 100 W	E40	1.30	Z 250..., Z 400...	NaHj 100	PZ 1000KD20	NaHj 100PZT	—	—	VNaHj 100	—
GE	CMH100PAR	E26	1.10	Z 250..., Z 400...	NaHj 100	PZ 1000KD20	NaHj 100PZT	—	—	VNaHj 100	—
GE	LUCALOX XO	E40	1.11	Z 250..., Z 400...	NaHj 100	PZ 1000KD20	NaHj 100PZT	—	—	VNaHj 100	—
Osram	HCI-E/P	E27	1.20	Z 250..., Z 400...	NaHj 100	PZ 1000KD20	NaHj 100PZT	—	—	VNaHj 100	—
Osram	HCI-T/P	E27	1.20	Z 250..., Z 400...	NaHj 100	PZ 1000KD20	NaHj 100PZT	—	—	VNaHj 100	—
Osram	HCI-T	G12	1.10	Z 250..., Z 400...	NaHj 100	PZ 1000KD20	NaHj 100PZT	—	—	VNaHj 100	—
Philips	CDO-ET	E40	1.20	Z 250..., Z 400...	NaHj 100	PZ 1000KD20	NaHj 100PZT	—	—	VNaHj 100	—
Philips	CDO-TT	E40	1.20	Z 250..., Z 400...	NaHj 100	PZ 1000KD20	NaHj 100PZT	—	—	VNaHj 100	—
Philips	CDM-T Elite	G12	1.14	Z 250..., Z 400...	NaHj 100	PZ 1000KD20	NaHj 100PZT	—	—	VNaHj 100	—
Lamp output 150 W											
Aura	TT 150 W	E40	1.70	Z 250..., Z 400...	NaHj 150	PZ 1000KD20	NaHj 150PZT	—	—	VNaHj 150	—
BLV	CHIT	G12	1.85	Z 250..., Z 400...	NaHj 150	PZ 1000KD20	NaHj 150PZT	—	—	VNaHj 150	EHXc 150
BLV	CHIT-DE	RX7s-24	1.80	Z 250..., Z 400...	NaHj 150	PZ 1000KD20	NaHj 150PZT	—	—	VNaHj 150	—
GE	CMH150T	G12	1.85	Z 250..., Z 400...	NaHj 150	PZ 1000KD20	NaHj 150PZT	—	—	VNaHj 150	EHXc 150
GE	CMH150TD	RX7s	1.80	Z 250..., Z 400...	NaHj 150	PZ 1000KD20	NaHj 150PZT	—	—	VNaHj 150	EHXc 150
Osram	HCI-E/P	E27	1.80	Z 250..., Z 400...	NaHj 150	PZ 1000KD20	NaHj 150PZT	—	—	VNaHj 150	EHXc 150
Osram	HCI-T	G12	1.80	Z 250..., Z 400...	NaHj 150	PZ 1000KD20	NaHj 150PZT	—	—	VNaHj 150	EHXc 150
Osram	HCI-T/P	E27	1.80	Z 250..., Z 400...	NaHj 150	PZ 1000KD20	NaHj 150PZT	—	—	VNaHj 150	EHXc 150
Osram	HCI-TS	RX7s-24	1.80	Z 250..., Z 400...	NaHj 150	PZ 1000KD20	NaHj 150PZT	HZ 1000K	NaHj 150	VNaHj 150	—
Osram	HCI-T	E40	1.80	Z 250..., Z 400...	NaHj 150	PZ 1000KD20	NaHj 150PZT	—	—	VNaHj 150	EHXc 150
Philips	CDO-ET	E40	1.80	Z 250..., Z 400...	NaHj 150	PZ 1000KD20	NaHj 150PZT	—	—	VNaHj 150	EHXc 150
Philips	CDO-TT	E40	1.80	Z 250..., Z 400...	NaHj 150	PZ 1000KD20	NaHj 150PZT	—	—	VNaHj 150	EHXc 150
Philips	CDM-T	G12	1.80-1.90	Z 250..., Z 400...	NaHj 150	PZ 1000KD20	NaHj 150PZT	—	—	VNaHj 150	EHXc 150
Philips	CDM-TD	RX7s	1.80	Z 250..., Z 400...	NaHj 150	PZ 1000KD20	NaHj 150PZT	HZ 1000K	NaHj 150	VNaHj 150	EHXc 150
Philips	CDM-TP	PGX12-2	1.80	Z 250..., Z 400...	NaHj 150	PZ 1000KD20	NaHj 150PZT	—	—	VNaHj 150	EHXc 150
Radium	RCC-T	G12	1.80	Z 250..., Z 400...	NaHj 150	PZ 1000KD20	NaHj 150PZT	HZ 1000K	NaHj 150	VNaHj 150	EHXc 150
Radium	RCC-TS	RX7s	1.80	Z 250..., Z 400...	NaHj 150	PZ 1000KD20	NaHj 150PZT	—	—	VNaHj 150	EHXc 150
Sylvania	CMH-T	G12	1.82	Z 250..., Z 400...	NaHj 150	PZ 1000KD20	NaHj 150PZT	—	—	VNaHj 150	EHXc 150
Sylvania	CMH-TD	RX7s-24	1.82	Z 250..., Z 400...	NaHj 150	PZ 1000KD20	NaHj 150PZT	—	—	VNaHj 150	—
Venture	CMH150/T	G12	1.85	Z 250..., Z 400...	NaHj 150	PZ 1000KD20	NaHj 150PZT	—	—	VNaHj 150	EHXc 150
Venture	CMH150/TD	RX7s	1.80	Z 250..., Z 400...	NaHj 150	PZ 1000KD20	NaHj 150PZT	—	—	VNaHj 150	EHXc 150
Lamp output 250 W											
Aura	TT 250 W	E40	3.00	Z 250..., Z 400...	NaHj 250	PZ 1000KD20	NaHj 250PZT	—	—	VNaHj 250	—
GE	CMH250E	E40	2.70	Z 250..., Z 400...	NaHj 250	PZ 1000KD20	NaHj 250PZT	—	—	VNaHj 250	—
GE	CMH250P	E40	2.70	Z 250..., Z 400...	NaHj 250	PZ 1000KD20	NaHj 250PZT	—	—	VNaHj 250	—
GE	CMH-TT	E40	2.90	Z 250..., Z 400...	NaHj 250	PZ 1000KD20	NaHj 250PZT	—	—	VNaHj 250	—
Osram	HCI-E	E40	2.90	Z 250..., Z 400...	NaHj 250	PZ 1000KD20	NaHj 250PZT	—	—	VNaHj 250	—
Osram	HCI-TC	E40	2.90	Z 250..., Z 400...	NaHj 250	PZ 1000KD20	NaHj 250PZT	—	—	VNaHj 250	—
Osram	HCI-TM	G22	2.90	Z 250..., Z 400...	NaHj 250	PZ 1000KD20	NaHj 250PZT	HZ 1000K	NaHj 250	VNaHj 250	—
Osram	HCI-TS	E40, Fc2	3.00	Z 250..., Z 400...	NaHj 250	PZ 1000KD20	NaHj 250PZT	HZ 1000K	NaHj 250	VNaHj 250	—

1

2

3

4

5

6

7

8

9

10

Lamp Table for Discharge Lamps

Ceramic discharge tube lamps (C-HI)

Manu- facturer	Designation	Base	Lamp current	Superimposed ignition system		Pulse ignition system		Instant restrike ignition system		Control gear unit	EB
				Ignitor*	Ballast	Ignitor	Ballast	Ignitor	Ballast		
Lamp output 250 W											
Philips	CDO-TT	E40	3.00	Z 250..., Z 400...	NaHj 250	PZ 1000KD20	NaHj 250PZT	—	—	VNaHj 250	—
Philips	CDMT	G12	3.00	Z 250..., Z 400...	NaHj 250	PZ 1000KD20	NaHj 250PZT	—	—	VNaHj 250	—
Radium	RCC-E	E40	2.90	Z 250..., Z 400...	NaHj 250	PZ 1000KD20	NaHj 250PZT	—	—	VNaHj 250	—
Radium	RCC-T	E40	2.80	Z 250..., Z 400...	NaHj 250	PZ 1000KD20	NaHj 250PZT	—	—	VNaHj 250	—
Radium	RCC-TM	G22	2.90	Z 250..., Z 400...	NaHj 250	PZ 1000KD20	NaHj 250PZT	HZ 1000K	NaHj 250	VNaHj 250	—
Radium	RCC-TS	Fe2	3.00	Z 250..., Z 400...	NaHj 250	PZ 1000KD20	NaHj 250PZT	HZ 1000K	NaHj 250	VNaHj 250	—
Lamp output 400 W											
Aura	TT 400 W	E40	4.40	Z 400...	NaHj 400	PZ 1000KD20	NaHj 400PZT	—	—	VNaHj 400	—
GE	CMHTT	E40	4.60	Z 400M..., Z 400...	NaHj 400	PZ 1000KD20	NaHj 400PZT	—	—	VNaHj 400	—
Osram	HCI-TM	G22	4.45	Z 400M..., Z 400...	NaHj 400	PZ 1000KD20	NaHj 400PZT	—	—	VNaHj 400	—

* Z 400 M VS power ignitor is not suitable for C-HI lamps

Lamp Table for Discharge Lamps

Mercury vapour lamps (HM lamps)

Manufacturer	Designation	Base	Current	Operating devices Ballasts (ignitor not required)	Capacitor at 50 Hz
Lamp output 50 W					
GE	H 50	E27, B22d	0.62	Q 50, Q 80/50	7 µF
Iwasaki	HF 50 PD	E27	0.62	Q 50, Q 80/50	7 µF
Narva	NF 50	E27	0.62	Q 50, Q 80/50	7 µF
Osram	HQL 50	E27	0.62	Q 50, Q 80/50	7 µF
Philips	HPL 50	E27	0.62	Q 50, Q 80/50	7 µF
Radium	HRL 50	E27	0.62	Q 50, Q 80/50	7 µF
Sylvania	HSL 50	E27	0.62	Q 50, Q 80/50	7 µF
Lamp output 80 W					
GE	H 80	E27, B22d-3*	0.80	Q 80, Q 80/50, Q 125/80	8 µF
Iwasaki	HF 80 PD	E27	0.80	Q 80, Q 80/50, Q 125/80	8 µF
Narva	NF 80	E27	0.80	Q 80, Q 80/50, Q 125/80	8 µF
Osram	HQL 80	E27	0.80	Q 80, Q 80/50, Q 125/80	8 µF
Philips	HPL 80	E27	0.80	Q 80, Q 80/50, Q 125/80	8 µF
Radium	HRL 80	E27	0.80	Q 80, Q 80/50, Q 125/80	8 µF
Sylvania	HSL 80	E27	0.80	Q 80, Q 80/50, Q 125/80	8 µF
Lamp output 125 W					
GE	H 125	E27, B22d-3*	1.15	Q 125, Q 125/80	10 µF
Iwasaki	HF 125 PD	E27	1.15	Q 125, Q 125/80	10 µF
Narva	NF 125	E27	1.15	Q 125, Q 125/80	10 µF
Osram	HQL 125	E27, E40	1.15	Q 125, Q 125/80	10 µF
Philips	HPL 125	E27	1.15	Q 125, Q 125/80	10 µF
Radium	HRL 125	E27	1.15	Q 125, Q 125/80	10 µF
Sylvania	HSL 125	E27, B22d-3*	1.15	Q 125, Q 125/80	10 µF
Lamp output 250 W					
GE	H 250	E40	2.15	Q 250, U-Q 250/150	18 µF
Iwasaki	HF 250 PD	E40	2.15	Q 250, U-Q 250/150	18 µF
Narva	NF 250	E40	2.15	Q 250, U-Q 250/150	18 µF
Osram	HQL 250	E40	2.15	Q 250, U-Q 250/150	18 µF
Philips	HPL 250	E40	2.15	Q 250, U-Q 250/150	18 µF
Radium	HRL 250	E40	2.15	Q 250, U-Q 250/150	18 µF
Sylvania	HSL 250	E40	2.15	Q 250, U-Q 250/150	18 µF
Lamp output 400 W					
GE	H 400	E40	3.25	Q 400, U-Q 400/250	25 µF
Iwasaki	HF 400 PD	E40	3.25	Q 400, U-Q 400/250	25 µF
Narva	NF 400	E40	3.25	Q 400, U-Q 400/250	25 µF
Osram	HQL 400	E40	3.25	Q 400, U-Q 400/250	25 µF
Philips	HPL 400	E40	3.25	Q 400, U-Q 400/250	25 µF
Radium	HRL 400	E40	3.25	Q 400, U-Q 400/250	25 µF
Sylvania	HSL 400	E40	3.25	Q 400, U-Q 400/250	25 µF
Lamp output 700 W					
GE	H 700	E40	5.45	Q 700	40 µF
Iwasaki	HF 700 PD	E40	5.40	Q 700	40 µF
Narva	NF 700	E40	5.40	Q 700	40 µF
Osram	HQL 700	E40	5.40	Q 700	40 µF
Philips	HPL 700	E40	5.40	Q 700	40 µF
Radium	HRL 700	E40	5.40	Q 700	40 µF
Sylvania	HSL 700	E40	5.40	Q 700	40 µF
Lamp output 1000 W					
GE	H 1000	E40	7.50	Q 1000	60 µF
Iwasaki	HF 1000 PD	E40	7.50	Q 1000	60 µF
Narva	NF 1000	E40	7.50	Q 1000	60 µF
Osram	HQL 1000	E40	7.50	Q 1000	60 µF
Philips	HPL 1000	E40	7.50	Q 1000	60 µF
Radium	HRL 1000	E40	7.50	Q 1000	60 µF
Sylvania	HSL 1000	E40	7.50	Q 1000	60 µF

* The VS range does not include a lampholder for base B22d-3

Energy efficiency classification

The commission's regulation (EC) No. 245/2009 dated 18 March 2009 implementing Directive 2005/32/EC of the European Parliament and of the Council with regard to defining ecodesign requirements for fluorescent lamps without integrated ballast, high-pressure discharge lamps and for ballasts and luminaires needed for their operation, and repealing Directive 2000/55/EC of the European Parliament and of the Council (official title), has created a legal framework in the EU that defines fundamental requirements for operating efficient lighting technology products.

Although the Regulation predominantly applies to general lighting, it is also product-orientated and thus independent of any specific application. The efficiency and performance requirements (specifications governing performance features) apply to fluorescent lamps without integrated ballast, high-pressure discharge lamps as well as ballasts and luminaires needed to operate these lamps. A brief overview of the requirements governing high-pressure discharge lamps is provided in the following table (excerpt from the CELMA guide).

Stage	Requirements governing	
1 13.04.2010	Ballasts	<ul style="list-style-type: none"> No special requirements.
Interim Stage 13.09.2010	Luminaires	<ul style="list-style-type: none"> After 18 months: technical information must be made available, both online and in luminaire documentation (for luminaires > 2,000 Lumens)
2 13.04.2012	Ballasts	<ul style="list-style-type: none"> Introduction of minimum energy-efficiency index values for HID ballasts and their labelling: <ul style="list-style-type: none"> $P < 30 \text{ W} - \eta \geq 65 \%$ $30 < P < 75 \text{ W} - \eta \geq 75 \%$ $75 < P < 105 \text{ W} - \eta \geq 80 \%$ $105 < P < 405 \text{ W} - \eta \geq 85 \%$ $P > 405 \text{ W} - \eta \geq 90 \%$ HID ballasts to be labelled: EEI=A3
	Luminaires	<ul style="list-style-type: none"> Luminaire designs must permit the integration of 3rd-stage ballasts. Exception: luminaires > IP4X
at the latest by 13.04.2014	Revision of the regulation Technological progress as well as the sum of the experience gained during the implementation of the Regulation be taken into consideration during the revision process..	
3 13.04.2017	Ballasts	<ul style="list-style-type: none"> Minimum energy-efficiency index values will be raised: <ul style="list-style-type: none"> $P < 30 \text{ W} - \eta \geq 78 \%$ $30 < P < 75 \text{ W} - \eta \geq 85 \%$ $75 < P < 105 \text{ W} - \eta \geq 87 \%$ $105 < P < 405 \text{ W} - \eta \geq 90 \%$ $P > 405 \text{ W} - \eta \geq 92 \%$ HID ballasts to be labelled: A2
	Luminaires	<ul style="list-style-type: none"> All luminaire designs must permit the integration of 3rd-stage ballasts.

Directive EU 245/2009 stipulates limit values governing the energy consumption of lamps, luminaires and control gear, regardless of the technology, and applies to both electromagnetic and electronic control gear. Since the directive will apply in all EU member states with effect from 13th April 2017, it will only be possible to put products into circulation on this market onwards of this date if they comply with the energy efficiency values of stage three of directive EU 245/2009.

However, **outside of the EU** it will continue to be possible to market products of all energy classes, as before, in compliance with local laws and directives.

Warehouse stock held by traders may continue to be marketed without restrictions – even within the EU – after 13th April 2017.

Requirements for replacements constitute a special case with regard to the new directive. If the device in question is to be used for replacement purposes only, the device – even with poorer energy efficiency values than stipulated in the directive and without a CE mark – may be used to replace a defective unit in an existing luminaire.

The **approbation of a luminaire** will not be invalidated by replacing a defective control gear unit with an equivalent replacement control gear unit.

1

2

3

4

5

6

7

8

9

10

WARMSTART, DIMMABLE AND INSTANT START



ELECTRONIC BALLASTS

Operating fluorescent lamps with electronic ballasts yields numerous advantages with regard to efficiency and convenience. Further details are provided on the respective product pages and the technical appendix.

The brightness of fluorescent lamps can also be regulated with the help of dimmable electronic ballasts. Adjusting lamp wattage leads to a further reduction of energy consumption and of the associated costs. The corresponding ELXd units from Vossloh-Schwabe enable conventional 1–10 V control units to be connected via a bipolar 1–10 V dimmer interface.

Moreover, Vossloh-Schwabe's product range also contains electronic ballasts that can be dimmed using conventional light sensors or polarity-independent dimmer interfaces via DALI-compatible control units. Both interfaces (1–10 V and DALI) were developed in accordance with EN 60929. Under consideration of the maximum current of the respective control unit, it is also possible to operate several electronic ballasts in parallel.

Electronic ballasts for compact fluorescent lamps

ELXc – Warm start – Linear casing shape	
ELXd – Dimmable – Linear casing shape	
ELXc – Warm start – Compact casing shape	
ECO EffectLine	
ELXd – Dimmable – Compact casing shape	

122–135

	122
	123–124
	125–130
	131
	132–135

Electronic ballasts for tubular fluorescent lamps

ELXc – Warm start – Linear casing shape	
EffectLine and EffectLine II	
New T5 EffectLine	
ECO EffectLine	
ELXd – Dimmable – Linear casing shape	

136–143

	136–140
	138
	139
	140
	141–143

Accessories for dimmable electronic built-in ballasts**144****Technical details for fluorescent lamps**

General technical details	
Glossary	

208–235

	348–356
	357–359

ELXc – Warm Start for TC-F, TC-L Lamps

Electronic built-in ballasts

Casing: metal

Power factor: > 0.96

DC voltage

for operation: 176–264 V

for ignition: 198–264 V

(ELXc 180.866, 280.538: DC voltage cannot be reduced to 176 V)

Push-in terminals: 0.5–1 mm²

For the automatic luminaire wiring:

IDC terminals for leads H05V-U 0.5

RFI-suppressed

For luminaires of protection class I

Degree of protection: IP20

For lighting systems with

high switching frequency (> 5/day)

EOL shut down approved acc. to EN 61347 Test 2

M10/M11

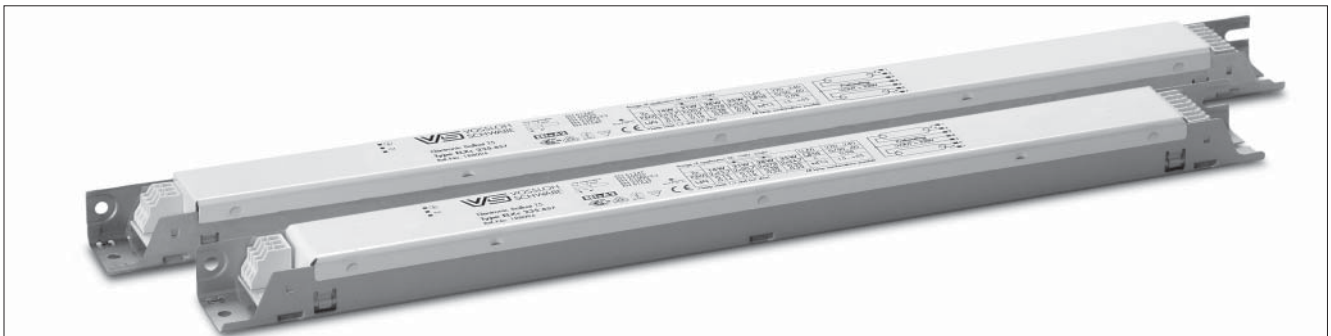
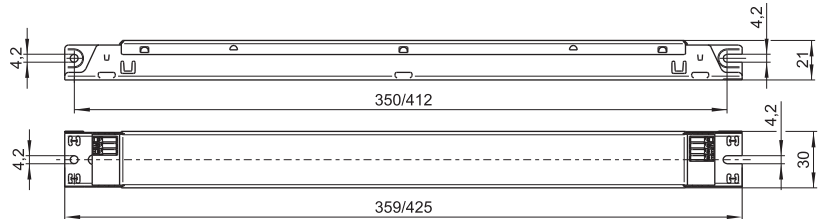

- T5 TC BUILT-IN 1-10 V
 T8 INDEPENDENT DALI/PUSH

Lamp				Electronic ballast							System	
Output W	Type	Base	Power consumption W	Type	Ref. No.	Voltage AC 50, 60 Hz V±10%	Energy efficiency	Ambient temperature t _a (°C)	Casing temperature t _c (°C)	Casing	Output W	Luminous factor %
18	TCF/L	2G10/2G11	1 x 16.0	ELXc 140.862	188140	220–240	A2	-15 to 55	max. 70	M10	19.0	109.0
2x18	TCF/L	2G10/2G11	2 x 16.0	ELXc 240.863	188616	220–240	A2 BAT	-15 to 55	max. 70	M10	35.0	105.3
24	TCF/L	2G10/2G11	1 x 22.0	ELXc 140.862	188140	220–240	A2	-15 to 55	max. 70	M10	27.0	109.0
2x24	TCF/L	2G10/2G11	2 x 22.0	ELXc 240.863	188616	220–240	A2 BAT	-15 to 55	max. 70	M10	51.0	106.8
36	TCF/L	2G10/2G11	1 x 32.0	ELXc 140.862	188140	220–240	A2	-15 to 55	max. 70	M10	35.0	101.0
2x36	TCF/L	2G10/2G11	2 x 32.0	ELXc 240.863	188616	220–240	A2 BAT	-15 to 55	max. 70	M10	71.0	98.7
40	TC-L	2G11	1 x 40.0	ELXc 140.862	188140	220–240	A2	-15 to 55	max. 70	M10	46.0	104.0
2x40	TC-L	2G11	2 x 40.0	ELXc 240.863	188616	220–240	A2 BAT	-15 to 55	max. 70	M10	89.0	103.6
55	TC-L	2G11	1 x 55.0	ELXc 180.866	188144	220–240	A2 BAT	-15 to 55	max. 70	M10	62.0	107.3
2x55	TC-L	2G11	2 x 50.0	ELXc 254.865	188618	220–240	A2 BAT	-15 to 50	max. 70	M10	112.0	92.9
			2 x 55.0	ELXc 280.538	188619	220–240	A2 BAT	-15 to 50	max. 70	M11	120.0	100.0
80	TC-L	2G11	1 x 80.0	ELXc 180.866	188144	220–240	A2 BAT	-15 to 55	max. 70	M10	87.0	97.6
2x80	TC-L	2G11	2 x 80.0	ELXc 280.538	188619	220–240	A2 BAT	-15 to 50	max. 70	M11	175.0	100.0

Circuit diagrams see pages 220–223

ELXd – Dimmable for TC-F, TC-L Lamps

Electronic built-in ballasts

Casing: metal

Dimming range:

approx. 1-100% of lamp power

Power factor: ≥ 0.95 at 100% operation

DC voltage

for operation: 154–276 V (M22, M23, M24)

for operation: 176–264 V (M9)

for ignition: 198–264 V

Push-in terminals: 0.5–1 mm²

For the automatic luminaire wiring:

IDC terminals for leads H05V-U 0.5

RFI-suppressed

For luminaires of protection class I

Degree of protection: IP20

Fixing holes for screws M4

for lateral or base mounting

For lighting systems with
high switching frequency (> 5/day)

EOL shut down approved acc. to EN 61347 Test 2

M9

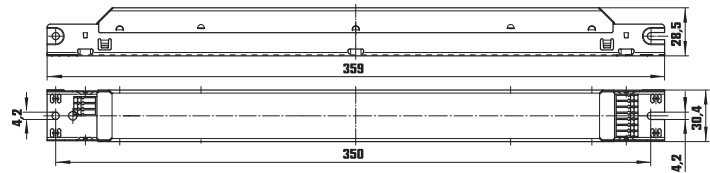

M23

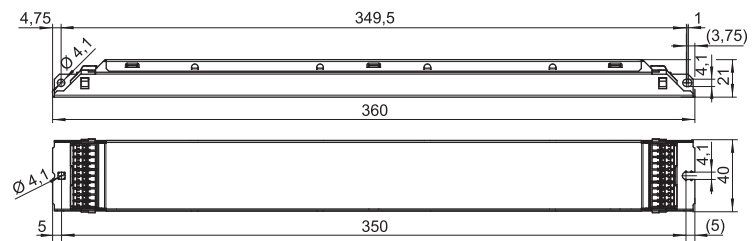

M22/M24

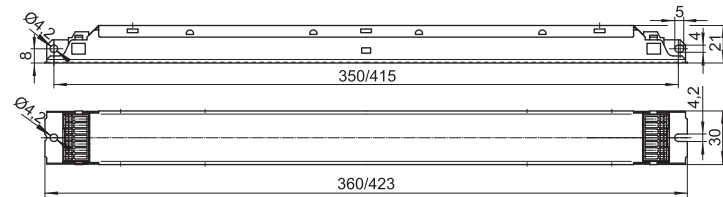

1

2

3

4

5

6

7

8

9

10

Electronic Ballasts for TC and T Lamps

ELXd – Dimmable 1–10 V for TC-F, TC-L lamps

Control voltage: DC 1–10 V

acc. to EN 60929 with earth leakage current 0.5 mA

(protected if connected to mains voltage)

For use with open- or closed-loop control units

T5 TC BUILT-IN 1–10 V
 T8 INDEPENDENT DALI/PUSH

Lamp				Electronic ballast							System	
Output W	Type	Base	Power consumption W	Type	Ref. No.	Voltage AC 50, 60 Hz V±10%	Energie efficiency	Ambient temperature t _a (°C)	Casing temperature t _c (°C)	Casing	Output W	Luminous factor %
18	TC-F/L	2G10/2G11	1 x 16.0	ELXd 118.718	188873	220–240	EEL=A1	10 to 50	max. 70	M9	18.0	94.0
2x18	TC-F/L	2G10/2G11	2 x 16.0	ELXd 218.719	188874	220–240	EEL=A1	10 to 50	max. 70	M9	36.0	90.6
24	TC-F/L	2G10/2G11	1 x 22.0	ELXd 118.718	188873	220–240	EEL=A1	10 to 50	max. 70	M9	27.0	96.6
			1 x 23.0	ELXd 124.607	188336	220–240	A1 BAT	10 to 50	max. 75	M22	26.0	100.0
2x24	TC-F/L	2G10/2G11	2 x 22.0	ELXd 218.719	188874	220–240	EEL=A1	10 to 50	max. 70	M9	52.0	100.8
			2 x 23.0	ELXd 224.608	188337	220–240	A1 BAT	10 to 50	max. 75	M24	49.0	100.0
3x24	TC-F/L	2G10/2G11	3 x 24.0	ELXd 324.623	188597	220–240	A1 BAT	10 to 50	max. 75	M23	73.4	100.0
4x24	TC-F/L	2G10/2G11	4 x 24.0	ELXd 424.624	188598	220–240	A1 BAT	10 to 50	max. 75	M23	97.6	100.0
36	TC-F/L	2G10/2G11	1 x 32.0	ELXd 136.720	188875	220–240	A1 BAT	10 to 50	max. 70	M9	37.3	93.5
2x36	TC-F/L	2G10/2G11	2 x 32.0	ELXd 236.721	188876	220–240	EEL=A1	10 to 50	max. 70	M9	72.0	92.6
40	TC-L	2G11	1 x 38.0	ELXd 139.609	188338	220–240	A1 BAT	10 to 50	max. 75	M22	42.0	100.0
2x40	TC-L	2G11	2 x 38.0	ELXd 239.610	188339	220–240	A1 BAT	10 to 50	max. 75	M24	82.0	100.0
55	TC-L	2G11	1 x 51.0	ELXd 158.722	188877	220–240	EEL=A1	10 to 50	max. 70	M9	56.0	92.5
			1 x 54.0	ELXd 154.611	188340	220–240	A1 BAT	10 to 50	max. 75	M22	59.0	100.0
2x55	TC-L	2G11	2 x 54.0	ELXd 254.612	188341	220–240	A1 BAT	10 to 50	max. 75	M24	115.0	100.0
80	TC-L	2G11	1 x 80.0	ELXd 180.613	188342	220–240	A1 BAT	10 to 50	max. 75	M22	88.0	100.0

Circuit diagrams see pages 220–223

ELXd – Dimmable with push key or DALI for TC-F, TC-L lamps

Complete implementation of the DALI-standard:

addressable, memory store for scenes and groups,

revertive information communication, physical and

RND-selection, standardized lamp characteristic

Low-power design ensures very low standby

power consumption

standby power consumption: ≤ 0.2 W

T5 TC BUILT-IN 1–10 V
 T8 INDEPENDENT DALI/PUSH

Lamp				Electronic ballast							System	
Output W	Type	Base	Power consumption W	Type	Ref. No.	Voltage AC 50, 60 Hz V±10%	Energie efficiency	Ambient temperature t _a (°C)	Casing temperature t _c (°C)	Casing	Output W	Luminous factor %
24	TC-F/L	2G10/2G11	1 x 23.0	ELXd 124.600	188329	220–240	A1 BAT	10 to 50	max. 75	M22	26.0	100.0
2x24	TC-F/L	2G10/2G11	2 x 23.0	ELXd 224.601	188330	220–240	A1 BAT	10 to 50	max. 75	M24	49.0	100.0
3x24	TC-F/L	2G10/2G11	3 x 23.0	ELXd 324.626	188600	220–240	A1 BAT	10 to 50	max. 75	M23	73.4	100.0
4x24	TC-F/L	2G10/2G11	4 x 23.0	ELXd 424.628	188602	220–240	A1 BAT	10 to 50	max. 75	M23	97.6	100.0
40	TC-L	2G11	1 x 38.0	ELXd 139.602	188331	220–240	A1 BAT	10 to 50	max. 75	M22	42.0	100.0
2x40	TC-L	2G11	2 x 38.0	ELXd 239.621	188350	220–240	A1 BAT	10 to 50	max. 75	M24	82.0	100.0
55	TC-L	2G11	1 x 54.0	ELXd 154.603	188332	220–240	A1 BAT	10 to 50	max. 75	M22	59.0	100.0
2x55	TC-L	2G11	2 x 54.0	ELXd 254.604	188333	220–240	A1 BAT	10 to 50	max. 75	M24	115.0	100.0
80	TC-L	2G11	1 x 80.0	ELXd 180.605	188334	220–240	A1 BAT	10 to 50	max. 75	M22	88.0	100.0

Circuit diagrams see pages 220–223

ELXc – Warm Start for Compact Fluorescent Lamps

Electronic ballasts

Casing: heat-resistant polyamide (K2, K3)
or heat-resistant polycarbonate (K2.1)

DC voltage

for operation: 176–264 V

for ignition: 198–264 V

(ELXc 242.837: DC voltage cannot
be reduced to 176 V)

Power factor: > 0.96 (K2.1: 0.98)

Push-in terminals with lever opener: 0.5–1.5 mm²
RFI-suppressed

Constant power consumption

For luminaires of protection class I

Degree of protection: IP20

Fixing brackets for screws M4

for lateral or base mounting

For lighting systems with
high switching frequency (> 5/day)
EOL shut down approved acc. to
EN 61347 Test 2

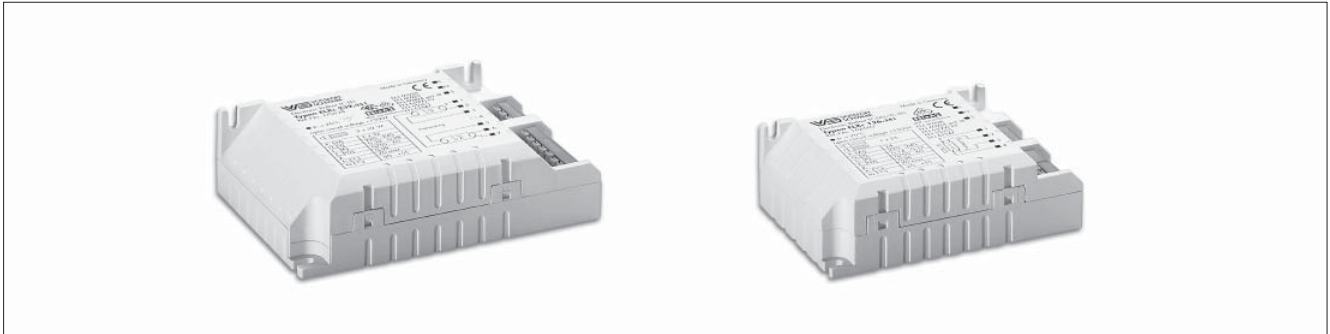

Electronic built-in ballasts

K2

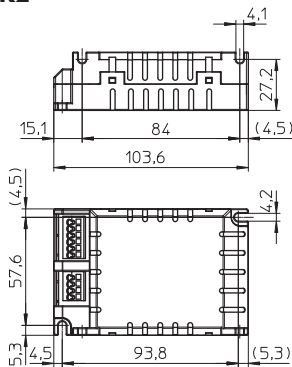

K3

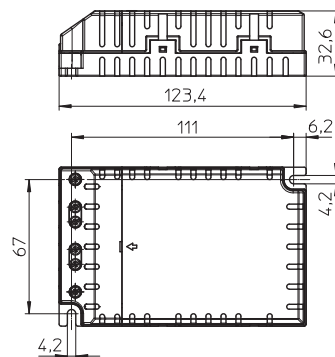

1

2

3

4

5

6

7

8

9

10

ELXc – Warm Start for Compact Fluorescent Lamps

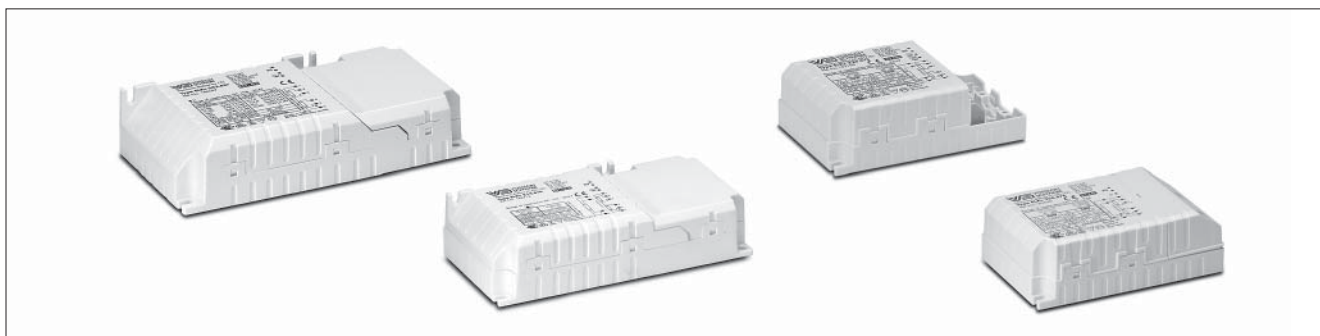

Independent electronic ballasts

K2 with cord grip

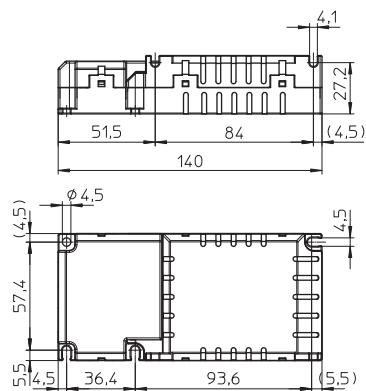

K2.1 with cord grip

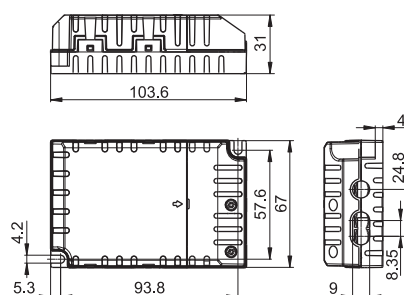

K3 with cord grip

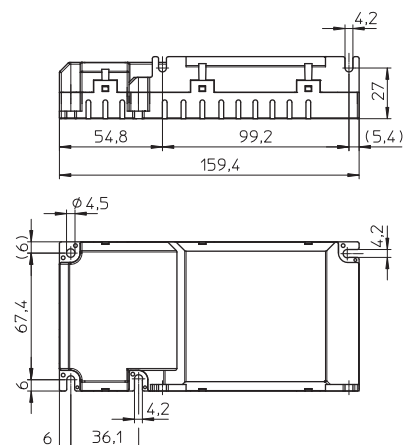

Electronic Ballasts for TC and T Lamps

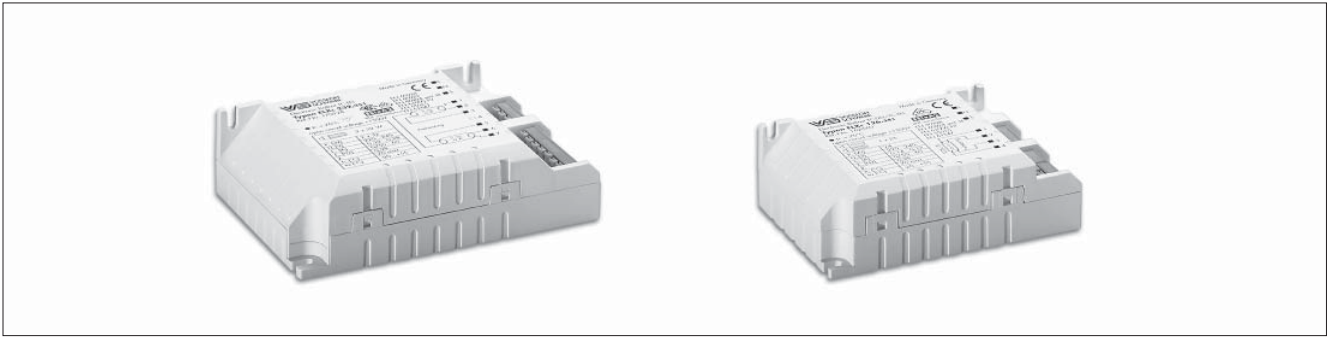

ELXc – Warm start for compact fluorescent lamps

Built-in ballasts

ELXc 213.870, 218.871, 142.872, 242.837, 155.378 have a second earth terminal to ground the luminaires for example

- T5 TC BUILT-IN 1-10 V
 T8 INDEPENDENT DALI/PUSH

Lamp				Electronic ballast							System	
Output W	Type	Base	Power consumption W	Type	Ref. No.	Voltage AC 50, 60 Hz V±10%	Energie efficiency	Ambient temperature t _a (°C)	Casing temperature t _c (°C)	Casing	Output W	Luminous factor %
9	TC-SEL	2G7	1 x 8.0	ELXc 213.870	188698	220-240	A2 BAT	-20 to 50	max. 65	K2	10.7	102.9
2x9	TC-SEL	2G7	2 x 8.0	ELXc 213.870	188698	220-240	A2 BAT	-20 to 50	max. 65	K2	19.4	102.9
10	TC-DEL	G24q-1	1 x 9.5	ELXc 213.870	188698	220-240	A2 BAT	-20 to 50	max. 65	K2	10.9	99.2
2x10	TC-DEL	G24q-1	2 x 9.5	ELXc 213.870	188698	220-240	A2 BAT	-20 to 50	max. 65	K2	20.5	98.8
11	TC-SEL	2G7	1 x 11.0	ELXc 213.870	188698	220-240	A2 BAT	-20 to 50	max. 65	K2	14.7	110.1
2x11	TC-SEL	2G7	2 x 11.0	ELXc 213.870	188698	220-240	A2 BAT	-20 to 50	max. 65	K2	27.9	116.1
13	TC-DEL/-TEL	G24q-1/GX24q-1	1 x 12.5	ELXc 213.870	188698	220-240	A2 BAT	-20 to 50	max. 65	K2	15.0	102.9
2x13	TC-DEL/-TEL	G24q-1/GX24q-1	2 x 12.5	ELXc 213.870	188698	220-240	A2 BAT	-20 to 50	max. 65	K2	28.1	110.9
18	TC-DEL/-TEL	G24q-2/GX24q-2	1 x 16.5	ELXc 218.871	188699	220-240	A2 BAT	-20 to 50	max. 65	K2	21.0	104.8
	TC-F/-L	2G10/2G11	1 x 16.0	ELXc 142.872	188700	220-240	A2 BAT	-20 to 50	max. 65	K2	18.0	102.0
2x18	TC-DEL/-TEL	G24q-2/GX24q-2	2 x 16.5	ELXc 218.871	188699	220-240	A2 BAT	-20 to 50	max. 65	K2	38.0	100.7
	TC-F/-L	2G10/2G11	2 x 16.0	ELXc 242.837	188643	220-240	A2 BAT	-20 to 50	max. 65	K3	35.0	104.3
				ELXc 142.872	188700	220-240	A2 BAT	-20 to 50	max. 65	K2	34.0	98.0
22	T-R5	2GX13	1 x 22.0	ELXc 142.872	188700	220-240	A2 BAT	-20 to 50	max. 65	K2	26.0	103.0
				ELXc 128.869	188589	220-240	A2 BAT	-20 to 50	max. 70	K2	25.0	96.7
22+40	T-R5	2GX13	1 x 22+40	ELXc 242.837	188643	220-240	A2 BAT	-20 to 50	max. 65	K3	68.0	100.0
2x22	T-R5	2GX13	2 x 22.0	ELXc 242.837	188643	220-240	A2 BAT	-20 to 50	max. 65	K3	48.5	105.8
24	TC-F/-L	2G10/2G11	1 x 22.0	ELXc 142.872	188700	220-240	A2 BAT	-20 to 50	max. 65	K2	27.0	105.0
			1 x 22.5	ELXc 128.869	188589	220-240	A2	-20 to 50	max. 70	K2	25.0	95.8
2x24	TC-F/-L	2G10/2G11	2 x 22.0	ELXc 242.837	188643	220-240	A2 BAT	-20 to 50	max. 65	K3	48.5	106.2
				ELXc 142.872	188700	220-240	A2 BAT	-20 to 50	max. 65	K2	47.0	102.0
26	TC-DEL/-TEL	G24q-3/GX24q-3	1 x 24.0	ELXc 142.872	188700	220-240	A2 BAT	-20 to 50	max. 65	K2	26.0	104.0
2x26	TC-DEL/-TEL	G24q-3/GX24q-3	2 x 24.0	ELXc 242.837	188643	220-240	A2 BAT	-20 to 50	max. 65	K3	53.0	106.1
				ELXc 142.872	188700	220-240	A2 BAT	-20 to 50	max. 65	K2	53.0	105.0

Circuit diagrams see pages 220-223

Electronic Ballasts for TC and T Lamps

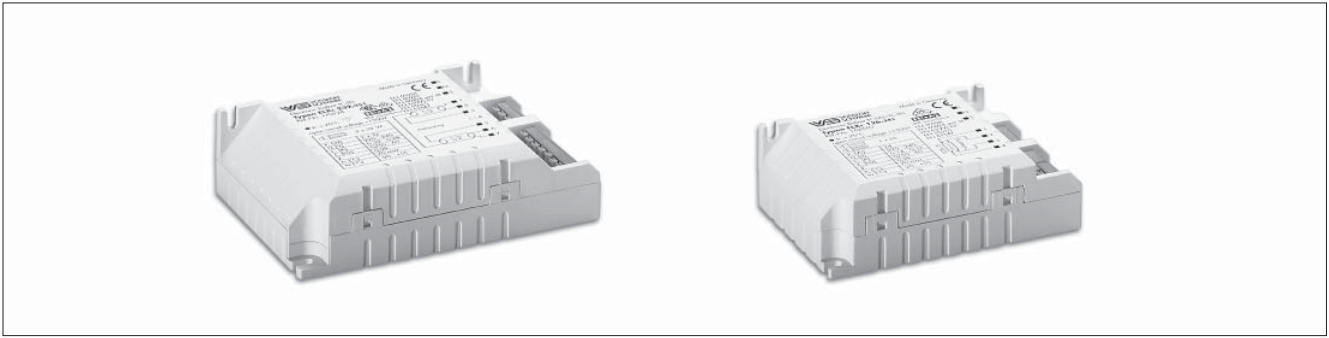

ELXc – Warm start for compact fluorescent lamps Built-in ballasts

ELXc 213.870, 218.871, 142.872,
242.837, 155.378 have a second earth terminal
to ground the luminaires for example

- T5 TC BUILT-IN 1-10 V
 T8 INDEPENDENT DALI/PUSH

Lamp				Electronic ballast							System	
Output W	Type	Base	Power consumption W	Type	Ref. No.	Voltage AC 50, 60 Hz V±10%	Energie efficiency	Ambient temperature t _a [°C]	Casing temperature t _c [°C]	Casing	Output W	Luminous factor %
28	TC-DD	GR10q	1 x 26.0	ELXc 128.869	188589	220-240	A2 BAT	-20 to 50	max. 70	K2	32.0	98.1
32	TC-TEL	GX24q-3	1 x 32.0	ELXc 142.872	188700	220-240	A2 BAT	-20 to 50	max. 65	K2	33.0	102.0
2x32	TC-TEL	GX24q-3	2 x 32.0	ELXc 242.837	188643	220-240	A2 BAT	-20 to 50	max. 65	K3	70.5	104.8
36	TC-F/L	2G10/2G11	1 x 32.0	ELXc 142.872	188700	220-240	A2 BAT	-20 to 50	max. 65	K2	34.0	105.0
2x36	TC-F/L	2G10/2G11	2 x 32.0	ELXc 242.837	188643	220-240	A2 BAT	-20 to 50	max. 65	K3	70.5	101.8
38	TC-DD	GR10q	1 x 36.0	ELXc 142.872	188700	220-240	A2 BAT	-20 to 50	max. 65	K2	38.0	95.0
2x38	TC-DD	GR10q	2 x 36.0	ELXc 242.837	188643	220-240	A2 BAT	-20 to 50	max. 65	K3	79.2	101.3
40	TC-L	2G11	1 x 40.0	ELXc 142.872	188700	220-240	A2 BAT	-20 to 50	max. 65	K2	43.0	99.0
	T-R5	2GX13	1 x 40.0	ELXc 142.872	188700	220-240	A2 BAT	-20 to 50	max. 65	K2	41.0	96.0
2x40	TC-L	2G11	2 x 40.0	ELXc 242.837	188643	220-240	A2 BAT	-20 to 50	max. 65	K3	88.0	101.3
	T-R5	2GX13	2 x 40.0	ELXc 242.837	188643	220-240	A2 BAT	-20 to 50	max. 65	K3	88.0	101.1
42	TC-TEL	GX24q-4	1 x 42.0	ELXc 142.872	188700	220-240	A2 BAT	-20 to 50	max. 65	K2	45.0	99.0
2x42	TC-TEL	GX24q-4	2 x 43.0	ELXc 242.837	188643	220-240	A2 BAT	-20 to 50	max. 65	K3	94.5	100.6
55	TC-L	2G11	1 x 55.6	ELXc 155.378	188680	220-240	A2 BAT	-20 to 50	max. 70	K3	60.0	102.4
	T-R5	2GX13	1 x 55.6	ELXc 155.378	188680	220-240	A2 BAT	-20 to 50	max. 70	K3	60.0	101.2
60	T-R5	2GX13	1 x 60.6	ELXc 155.378	188680	220-240	A2	-20 to 50	max. 70	K3	66.0	109.5
80	TC-L	2G11	1 x 80.5	ELXc 155.378	188680	220-240	A2 BAT	-20 to 50	max. 70	K3	88.0	101.3

Circuit diagrams see pages 220-223

Electronic Ballasts for TC and T Lamps



ELXc – Warm start for compact fluorescent lamps Independent ballasts

ELXc 213.870, 218.871, 142.872,
155.378 have a second earth terminal
to ground the luminaires

- T5 TC BUILT-IN 1-10 V
 T8 INDEPENDENT DALI/PUSH

Lamp				Electronic ballast							System	
Output W	Type	Base	Power con- sumption W	Type	Ref. No.	Voltage AC 50, 60 Hz V±10%	Energy efficiency	Ambient temperature t _a (°C)	Casing temperature t _c (°C)	Casing	Output W	Luminous factor %
9	TC-SEL	2G7	1 x 8.0	ELXc 213.870	188712	220-240	A2 BAT	-20 to 50	max. 65	K2	10.7	102.9
2x9	TC-SEL	2G7	2 x 8.0	ELXc 213.870	188712	220-240	A2 BAT	-20 to 50	max. 65	K2	19.4	102.9
10	TC-DEL	G24q-1	1 x 9.5	ELXc 213.870	188712	220-240	A2 BAT	-20 to 50	max. 65	K2	10.9	99.2
2x10	TC-DEL	G24q-1	2 x 9.5	ELXc 213.870	188712	220-240	A2 BAT	-20 to 50	max. 65	K2	20.5	98.8
11	TC-SEL	2G7	1 x 11.0	ELXc 213.870	188712	220-240	A2 BAT	-20 to 50	max. 65	K2	14.7	110.1
2x11	TC-SEL	2G7	2 x 11.0	ELXc 213.870	188712	220-240	A2 BAT	-20 to 50	max. 65	K2	27.9	116.1
13	TC-DEL/-TEL	G24q-1/GX24q-1	1 x 12.5	ELXc 213.870	188712	220-240	A2 BAT	-20 to 50	max. 65	K2	15.0	102.9
2x13	TC-DEL/-TEL	G24q-1/GX24q-1	2 x 12.5	ELXc 213.870	188712	220-240	A2 BAT	-20 to 50	max. 65	K2	28.1	110.9
18	TC-DEL/-TEL	G24q-2/GX24q-2	1 x 16.5	ELXc 218.871	188713	220-240	A2 BAT	-20 to 50	max. 65	K2	21.0	104.8
	TC-F/-L	2G10/2G11	1 x 16.0	ELXc 142.872	188714	220-240	A2 BAT	-20 to 50	max. 65	K2	18.0	102.0
2x18	TC-DEL/-TEL	G24q-2/GX24q-2	2 x 16.5	ELXc 218.871	188713	220-240	A2 BAT	-20 to 50	max. 65	K2	38.0	100.7
	TC-F/-L	2G10/2G11	2 x 16.0	ELXc 142.872	188714	220-240	A2 BAT	-20 to 50	max. 65	K2	34.0	98.0
22	T-R5	2GX13	1 x 22.0	ELXc 142.872	188714	220-240	A2 BAT	-20 to 50	max. 65	K2	26.0	103.0
				ELXc 128.869	188590	220-240	A2 BAT	-20 to 50	max. 70	K2	25.0	96.7
24	TC-F/-L	2G10/2G11	1 x 22.0	ELXc 142.872	188714	220-240	A2 BAT	-20 to 50	max. 65	K2	27.0	105.0
	TC-F/-L	2G10/2G11	1 x 22.5	ELXc 128.869	188590	220-240	A2	-20 to 50	max. 70	K2	25.0	95.8
2x24	TC-F/-L	2G10/2G11	2 x 22.0	ELXc 142.872	188714	220-240	A2 BAT	-20 to 50	max. 65	K2	47.0	102.0
26	TC-DEL/-TEL	G24q-3/GX24q-3	1 x 24.0	ELXc 142.872	188714	220-240	A2 BAT	-20 to 50	max. 65	K2	26.0	104.0
				ELXc 226.878	183040	220-240	A2 BAT	-20 to 55	max. 65	K2.1	28.0	104.0
				ELXc 226.878	183108*	220-240	A2 BAT	-20 to 55	max. 65	K2.1	28.0	104.0
2x26	TC-DEL/-TEL	G24q-3/GX24q-3	2 x 24.0	ELXc 226.878	183040	220-240	A2 BAT	-20 to 55	max. 65	K2.1	50.0	101.0
				ELXc 226.878	183108*	220-240	A2 BAT	-20 to 55	max. 65	K2.1	50.0	101.0
				ELXc 142.872	188714	220-240	A2 BAT	-20 to 50	max. 65	K2	53.0	105.0

Circuit diagrams see pages 220-223

* Without cover cap on cord grip = built-in version

Electronic Ballasts for TC and T Lamps

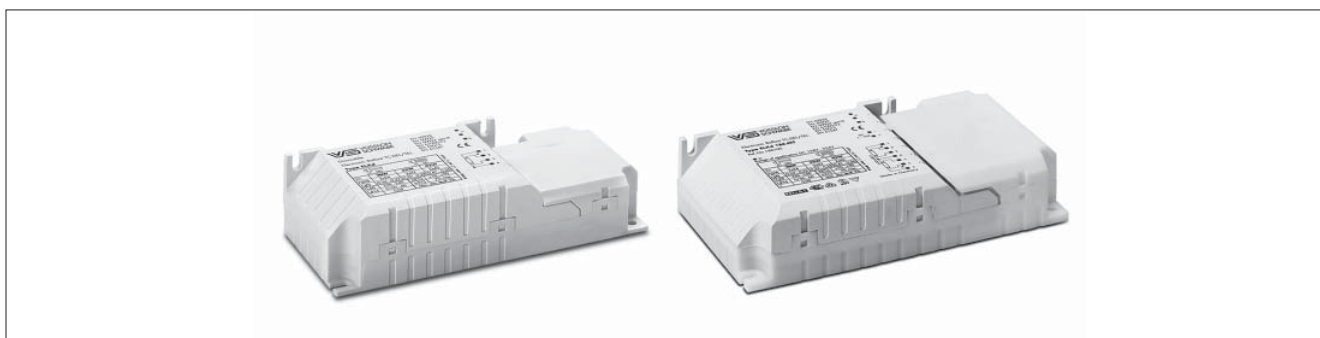

ELXc – Compact warm start for compact fluorescent lamps – Independent ballasts

ELXc 213.870, 218.871, 142.872,
155.378 have a second earth terminal
to ground the luminaires for example

- T5 TC BUILT-IN 1-10 V
 T8 INDEPENDENT DALI/PUSH

Lamp				Electronic ballast							System	
Output W	Type	Base	Power consumption W	Type	Ref. No.	Voltage AC 50, 60 Hz V±10%	Energy efficiency	Ambient temperature t _a (°C)	Casing temperature t _c (°C)	Casing	Output W	Luminous factor %
28	TC-DD	GR10q	1 x 26.0	ELXc 128.869	188590	220-240	A2 BAT	-20 to 50	max. 70	K2	32.0	98.1
32	TC-TEL	GX24q-3	1 x 32.0	ELXc 142.872	188714	220-240	A2 BAT	-20 to 50	max. 65	K2	33.0	102.0
36	TC-F/-L	2G10/2G11	1 x 32.0	ELXc 142.872	188714	220-240	A2 BAT	-20 to 50	max. 65	K2	34.0	105.0
38	TC-DD	GR10q	1 x 36.0	ELXc 142.872	188714	220-240	A2 BAT	-20 to 50	max. 65	K2	38.0	95.0
40	TC-L	2G11	1 x 40.0	ELXc 142.872	188714	220-240	A2 BAT	-20 to 50	max. 65	K2	43.0	99.0
	T-R5	2GX13	1 x 40.0	ELXc 142.872	188714	220-240	A2 BAT	-20 to 50	max. 65	K2	41.0	96.0
42	TC-TEL	GX24q-4	1 x 42.0	ELXc 142.872	188714	220-240	A2 BAT	-20 to 50	max. 65	K2	45.0	99.0
55	TC-L	2G11	1 x 55.6	ELXc 155.378	188681	220-240	A2 BAT	-20 to 50	max. 70	K3	60.0	102.4
	T-R5	2GX13	1 x 55.6	ELXc 155.378	188681	220-240	A2 BAT	-20 to 50	max. 70	K3	60.0	101.2
60	T-R5	2GX13	1 x 60.6	ELXc 155.378	188681	220-240	A2	-20 to 50	max. 70	K3	66.0	109.5
80	TC-L	2G11	1 x 80.5	ELXc 155.378	188681	220-240	A2 BAT	-20 to 50	max. 70	K3	88.0	101.3

Circuit diagrams see pages 220-223

ELXc – ECO EffectLine Warm Start for Compact Fluorescent Lamps

Electronic ballasts

Casing: PC, white

Mains voltage: 198–264 V

Push-in terminals: 0.5–1.5 mm²

RFI-suppressed

For luminaires of protection class I

Degree of protection: IP20

For lighting systems with
high switching frequency (> 5/day)

EOL shut down approved acc. to EN 61347 Test 1



K1.1

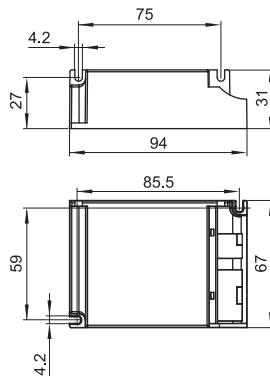

ELXc – Warm start for compact fluorescent lamps – Built-in ballasts

- T5 TC BUILT-IN 1–10 V
 T8 INDEPENDENT DALI/PUSH

Lamp				Electronic ballast								System	
Output W	Type	Base	Power consumption W	Type	Ref. No.	Voltage AC 50, 60 Hz V±10 %	Energy efficiency	Power factor	Ambient temperature t _a (°C)	Casing temperature t _c (°C)	Output W	Luminous factor %	
18	TC-DEL/-TEL	G24q-2/GX24q-2	1 x 16.5	ELXc 118.879	183134	220–240	A2	> 0.95	–10 to 50	max. 70	19.5	100	
2x18	TC-DEL/-TEL	G24q-2/GX24q-2	2 x 16.5	ELXc 218.881	183136	220–240	A2	> 0.95	–15 to 50	max. 75	38.0	100	
26	TC-DEL/-TEL	G24q-3/GX24q-3	1 x 24.0	ELXc 126.880	183135	220–240	A2	> 0.95	–10 to 50	max. 75	28.0	100	
2x26	TC-DEL/-TEL	G24q-3/GX24q-3	2 x 24.0	ELXc 226.882	183137	220–240	A2	> 0.95	–15 to 50	max. 80	53.5	100	

Circuit diagrams see pages 220–223

ELXd – Dimmable for TC-DEL, TC-TEL Lamps

Electronic ballasts

Casing: heat-resistant polycarbonate

Dimming range:

approx. 3–100% of lamp power

Push-in terminals with lever opener: 0.5–1.5 mm²
RFI-suppressed

Degree of protection: IP20

For luminaires of protection class I

Fixing brackets for screws M4

for lateral or base mounting

For lighting systems with
high switching frequency (> 5/day)

EOL shut down approved

acc. to EN 61347 Test 2

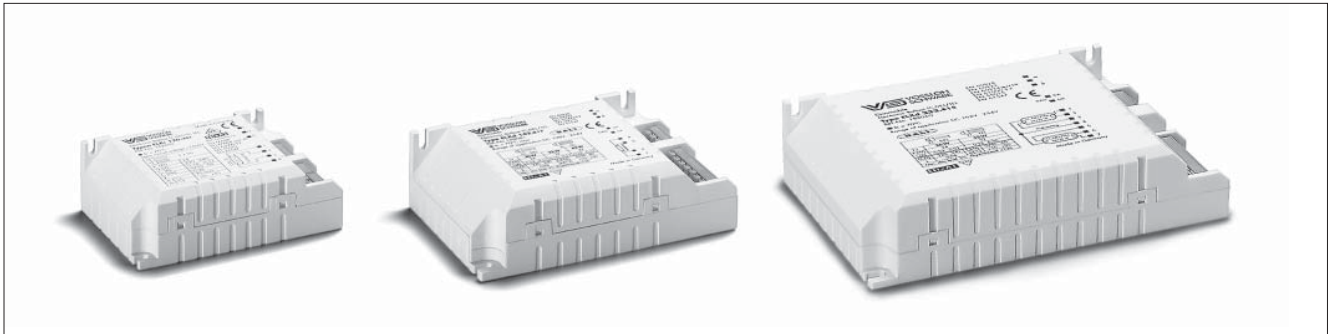

Electronic built-in ballasts

K2

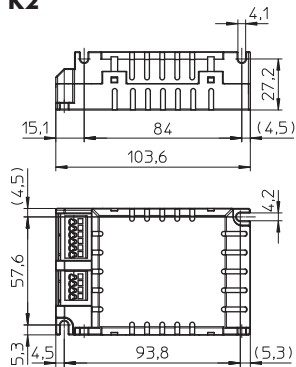

K3

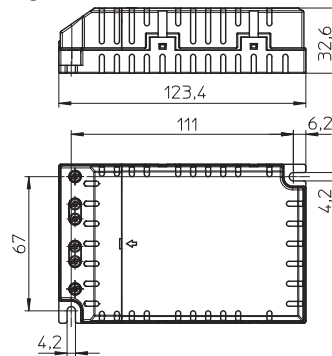

K4

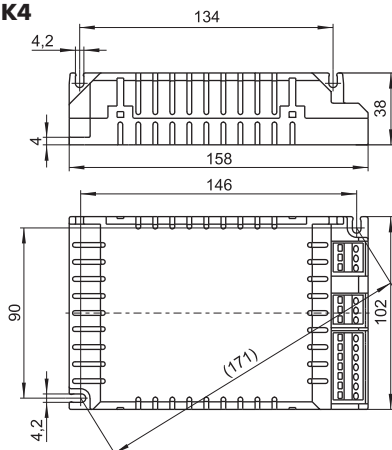

ELXd - Dimmable for TC-DEL, TC-TEL Lamps



Independent electronic ballasts

K2 with cord grip

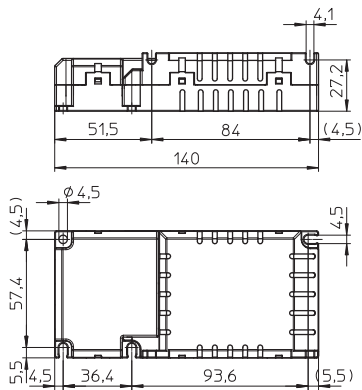

K3 with cord grip

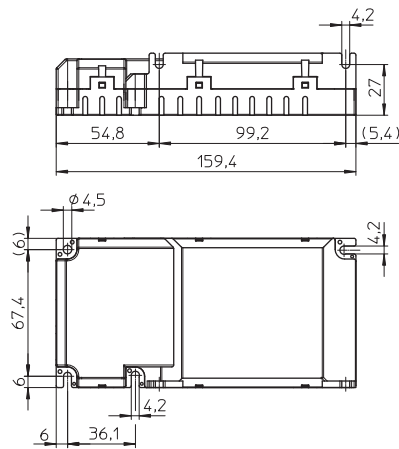

K4 with cord grip

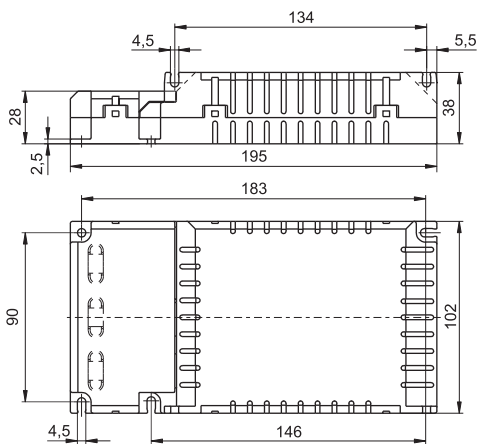

1

2

3

4

5

6

7

8

9

10

Electronic Ballasts for TC and T Lamps

ELXd – Dimmable 1–10 V for TC-DEL, TC-TEL lamps

Electronic built-in ballasts

Casing: K3, K4

Control voltage: DC 1–10 V acc. to

EN 60929 with earth leakage current 0.5 mA

(protected if connected to mains voltage)

For use with open- or closed-loop control units

Power factor: 0.98 at 100% operation

DC voltage

for operation: 176–264 V

for ignition: 198–264 V



Lamp				Electronic ballast							System	
Output W	Type	Base	Power consumption W	Type	Ref. No.	Voltage AC 50, 60 Hz V±10%	Energy efficiency	Ambient temperature t _a (°C)	Casing temperature t _c (°C)	Casing	Output W	Luminous factor %
18	TC-DEL/-TEL	G24q-2/GX24q-2	1 x 16.5	ELXd 118.802	188564	220–240	A1 BAT	5 to 55	max. 70	K3	21.0	100.0
2x18	TC-DEL/-TEL	G24q-2/GX24q-2	2 x 16.5	ELXd 218.803	188549	220–240	A1 BAT	5 to 55	max. 70	K4	38.0	100.0
26	TC-DEL/-TEL	G24q-3/GX24q-3	1 x 24.0	ELXd 142.806	188565	220–240	A1 BAT	10 to 50	max. 70	K3	27.0	100.0
2x26	TC-DEL/-TEL	G24q-3/GX24q-3	2 x 24.0	ELXd 242.807	188550	220–240	A1 BAT	10 to 50	max. 70	K4	53.0	100.0
				ELXd 226.801	188431	220–240	A1 BAT	10 to 50	max. 70	K3	54.0	100.0
32	TC-TEL	GX24q-3	1 x 32.0	ELXd 142.806	188565	220–240	A1 BAT	10 to 50	max. 70	K3	36.0	100.0
2x32	TC-TEL	GX24q-3	2 x 32.0	ELXd 242.807	188550	220–240	A1 BAT	10 to 50	max. 70	K4	71.0	100.0
42	TC-TEL	GX24q-4	1 x 43.0	ELXd 142.806	188565	220–240	A1 BAT	10 to 50	max. 70	K3	46.0	100.0
2x42	TC-TEL	GX24q-4	2 x 43.0	ELXd 242.807	188550	220–240	A1 BAT	10 to 50	max. 70	K4	92.0	100.0

Circuit diagrams see pages 220–223

ELXd – Dimmable 1–10 V for TC-DEL, TC-TEL lamps

Independent electronic ballasts

Casing with cord grip: K3, K4

Control voltage: DC 1–10 V acc. to

EN 60929 with earth leakage current 0.5 mA

(protected if connected to mains voltage)

For use with open- or closed-loop control units

Power factor: 0.98 at 100% operation

DC voltage

for operation: 176–264 V

for ignition: 198–264 V



Lamp				Electronic ballast							System	
Output W	Type	Base	Power consumption W	Type	Ref. No.	Voltage AC 50, 60 Hz V±10%	Energy efficiency	Ambient temperature t _a (°C)	Casing temperature t _c (°C)	Casing	Output W	Luminous factor %
18	TC-DEL/-TEL	G24q-2/GX24q-2	1 x 16.5	ELXd 118.802	188694	220–240	A1 BAT	5 to 55	max. 70	K3	21.0	100.0
2x18	TC-DEL/-TEL	G24q-2/GX24q-2	2 x 16.5	ELXd 218.803	188696	220–240	A1 BAT	5 to 55	max. 70	K4	38.0	100.0
26	TC-DEL/-TEL	G24q-3/GX24q-3	1 x 24.0	ELXd 142.806	188695	220–240	A1 BAT	10 to 50	max. 70	K3	27.0	100.0
2x26	TC-DEL/-TEL	G24q-3/GX24q-3	2 x 24.0	ELXd 242.807	188697	220–240	A1 BAT	10 to 50	max. 70	K4	53.0	100.0
				ELXd 226.801	188490	220–240	A1 BAT	10 to 50	max. 70	K3	54.0	100.0
32	TC-TEL	GX24q-3	1 x 32.0	ELXd 142.806	188695	220–240	A1 BAT	10 to 50	max. 70	K3	36.0	100.0
2x32	TC-TEL	GX24q-3	2 x 32.0	ELXd 242.807	188697	220–240	A1 BAT	10 to 50	max. 70	K4	71.0	100.0
42	TC-TEL	GX24q-4	1 x 43.0	ELXd 142.806	188695	220–240	A1 BAT	10 to 50	max. 70	K3	46.0	100.0
2x42	TC-TEL	GX24q-4	2 x 43.0	ELXd 242.807	188697	220–240	A1 BAT	10 to 50	max. 70	K4	92.0	100.0

Circuit diagrams see pages 220–223

Electronic Ballasts for TC and T Lamps

ELXd – Dimmable with push key or DALI for TC-DEL, TC-TEL lamps

Electronic ballasts

PUSH: dimmable with usual push key and sensor

DALI: poles are not polarity sensitive (protected if connected to mains voltage) for use with DALI compatible control units

Automatic restart after lamp has been changed

Power factor: > 0.95 at 100% operation

DC voltage

for operation: 176–264 V

for ignition: 198–264 V

Standby power consumption: ≤ 0.5 W

Complete implementation of the DALI-standard:

addressable, memory store for scenes and groups, revertive information communication, physical and RND-selection, standardized lamp characteristic

Low-power design ensures very low standby power consumption

Compatible with IEC 62386

Electronic built-in ballasts

T5 TC BUILT-IN 1–10 V
 T8 INDEPENDENT DALI/PUSH

Lamp				Electronic ballast							System	
Output W	Type	Base	Power consumption W	Type	Ref. No.	Voltage AC 50, 60 Hz V±10%	Energy efficiency	Ambient temperature t _a (°C)	Casing temperature t _c (°C)	Casing	Output W	Luminous factor %
2x18	TC-DEL/-TEL	G24q-2/GX24q-2	2 x 18.0	ELXd 218.707	188954	220–240	A1 BAT	10 to 50	max. 70	K3	40.0	100.1
26	TC-DEL/-TEL	G24q-3/GX24q-3	1 x 25.0	ELXd 142.709	188923	220–240	A1 BAT	10 to 50	max. 65	K2	27.5	106.8
2x26	TC-DEL/-TEL	G24q-3/GX24q-3	2 x 24.0	ELXd 242.711	188974	220–240	A1 BAT	10 to 50	max. 70	K3	56.0	97.9
32	TC-TEL	GX24q-3	1 x 32.0	ELXd 142.709	188923	220–240	A1 BAT	10 to 50	max. 65	K2	34.5	106.3
2x32	TC-TEL	GX24q-3	2 x 32.0	ELXd 242.711	188974	220–240	A1 BAT	10 to 50	max. 70	K3	69.0	97.6
42	TC-TEL	GX24q-4	1 x 42.0	ELXd 142.709	188923	220–240	A1 BAT	10 to 50	max. 65	K2	45.0	103.8
2x42	TC-TEL	GX24q-4	2 x 42.0	ELXd 242.711	188974	220–240	A1 BAT	10 to 50	max. 70	K3	90.0	99.1

Circuit diagrams see pages 220–223

Independent electronic ballasts

T5 TC BUILT-IN 1–10 V
 T8 INDEPENDENT DALI/PUSH

Lamp				Electronic ballast							System	
Output W	Type	Base	Power consumption W	Type	Ref. No.	Voltage AC 50, 60 Hz V±10%	Energy efficiency	Ambient temperature t _a (°C)	Casing temperature t _c (°C)	Casing	Output W	Luminous factor %
18	TC-DEL/-TEL	G24q-2/GX24q-2	1 x 16.5	ELXd 118.705	188953	220–240	A1BAT	10 to 50	max. 65	K2	20.2	105.5
2x18	TC-DEL/-TEL	G24q-2/GX24q-2	2 x 18.0	ELXd 218.707	188955	220–240	A1BAT	10 to 60	max. 70	K3	40.0	100.1
26	TC-DEL/-TEL	G24q-3/GX24q-3	1 x 25.0	ELXd 142.709	188924	220–240	A1BAT	10 to 50	max. 65	K2	27.5	106.3
2x26	TC-DEL/-TEL	G24q-3/GX24q-3	2 x 24.0	ELXd 242.711	188975	220–240	A1BAT	10 to 50	max. 70	K3	56.0	97.9
32	TC-TEL	GX24q-3	1 x 32.0	ELXd 142.709	188924	220–240	A1BAT	10 to 50	max. 65	K2	34.8	106.3
2x32	TC-TEL	GX24q-3	2 x 32.0	ELXd 242.711	188975	220–240	A1BAT	10 to 50	max. 70	K3	69.0	97.6
42	TC-TEL	GX24q-4	1 x 42.0	ELXd 142.709	188924	220–240	A1BAT	10 to 50	max. 65	K2	45.0	103.8
2x42	TC-TEL	GX24q-4	2 x 42.0	ELXd 242.711	188975	220–240	A1BAT	10 to 50	max. 70	K3	90.0	99.1

Circuit diagrams see pages 220–223

ELXc – Warm Start for T5 and T8 Lamps

Electronic built-in ballasts
 Casing: metal
 Power factor: ≥ 0.95
 RFI-suppressed
 For luminaires of protection class I

Degree of protection: IP20
 For lighting systems with
 high switching frequency ($> 5/\text{day}$)

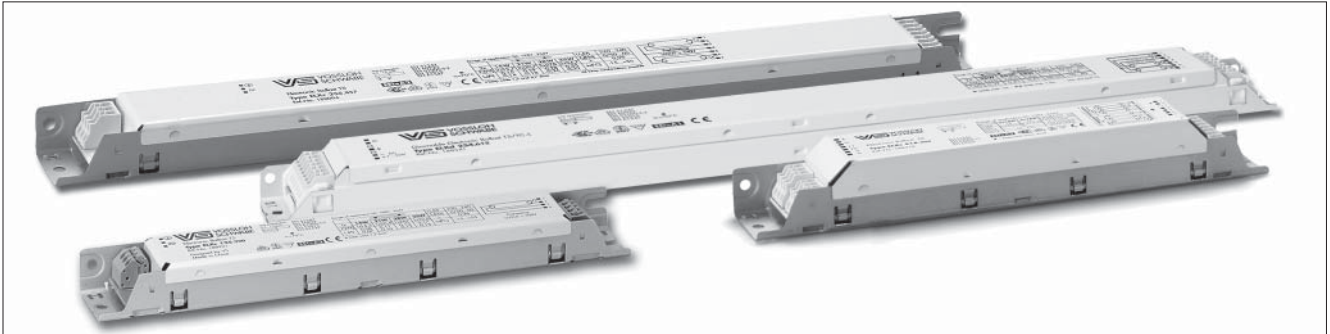

M6

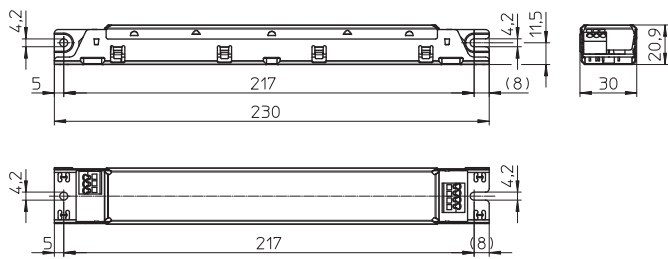

M8

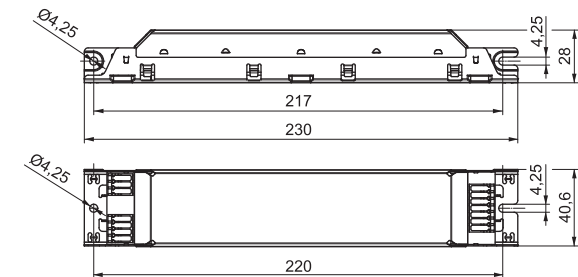

M10/M11

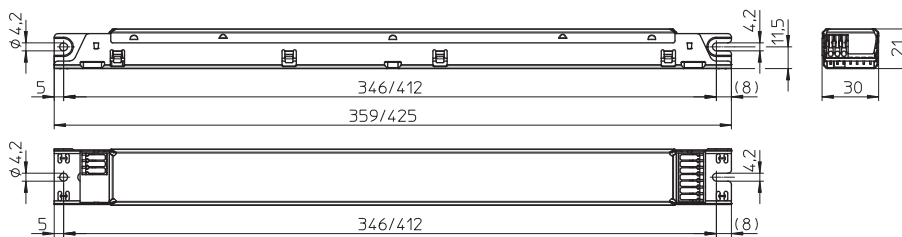

ELXc – Warm Start for T5 and T8 Lamps

DC voltage

for operation: 176–264 V

for ignition: 198–264 V

(ELXc 135.856, 235.857, 149.858,

154.864, 180.866, 280.538:

DC voltage cannot be reduced to 176 V)

Push-in terminals: 0.5–1 mm²

For the automatic luminaire wiring:

IDC terminals for leads H05V-U 0.5

EOL shut down approved

acc. to EN 61347 Test 2 (for T5)

EOL shut down (for T8)

T5 TC BUILT-IN 1–10 V
 T8 INDEPENDENT DALI/PUSH

Lamp				Electronic ballast							System	
Output	Type	Base	Power consumption	Type	Ref. No.	Voltage AC	Energy efficiency	Ambient temperature	Casing temperature	Casing	Output	Luminous factor
W			W			50, 60 Hz		t _a (°C)	t _c (°C)		W	%
V±10%												
For T5 lamps – Casing: M8, M10 and M11												
14	T5	G5	1 x 14.0	ELXc 135.856	188093	220–240	A2 BAT	–15 to 55	max. 70	M10	17.0	110.7
2x14	T5	G5	2 x 14.0	ELXc 235.857	188094	220–240	A2 BAT	–15 to 55	max. 70	M10	33.4	107.0
3x14	T5	G5	3 x 14.0	ELXc 414.868	188438	220–240	A2 BAT	–15 to 55	max. 70	M8	48.0	105.4
4x14	T5	G5	4 x 14.0	ELXc 414.868	188438	220–240	A2 BAT	–15 to 55	max. 70	M8	63.0	102.3
21	T5	G5	1 x 21.0	ELXc 135.856	188093	220–240	A2 BAT	–15 to 55	max. 70	M10	24.0	107.4
2x21	T5	G5	2 x 21.0	ELXc 235.857	188094	220–240	A2 BAT	–15 to 55	max. 70	M10	50.2	110.6
24	T5	G5	1 x 22.5	ELXc 140.862	188140	220–240	A2 BAT	–15 to 55	max. 70	M10	27.0	114.0
2x24	T5	G5	2 x 22.5	ELXc 240.863	188616	220–240	A2 BAT	–15 to 55	max. 70	M10	51.0	107.4
3x24	T5	G5	3 x 22.5	ELXc 424.223	183039	220–240	A2 BAT	–15 to 55	max. 75	M8	78.0	103.7
4x24	T5	G5	4 x 22.5	ELXc 424.223	183039	220–240	A2 BAT	–15 to 55	max. 75	M8	101.7	103.5
28	T5	G5	1 x 28.0	ELXc 135.856	188093	220–240	A2 BAT	–15 to 55	max. 70	M10	32.0	104.9
2x28	T5	G5	2 x 28.0	ELXc 235.857	188094	220–240	A2 BAT	–15 to 55	max. 70	M10	60.6	106.2
35	T5	G5	1 x 35.0	ELXc 135.856	188093	220–240	A2 BAT	–15 to 55	max. 70	M10	39.5	102.7
2x35	T5	G5	2 x 35.0	ELXc 235.857	188094	220–240	A2 BAT	–15 to 55	max. 70	M10	74.5	102.5
39	T5	G5	1 x 38.0	ELXc 140.862	188140	220–240	A2 BAT	–15 to 55	max. 70	M10	43.0	107.0
2x39	T5	G5	2 x 38.0	ELXc 240.863	188616	220–240	A2 BAT	–15 to 55	max. 70	M10	82.0	97.9
49	T5	G5	1 x 49.0	ELXc 149.858	188095	220–240	A2 BAT	–15 to 55	max. 70	M10	54.0	102.5
2x49	T5	G5	2 x 49.0	ELXc 249.859	188617	220–240	A2 BAT	–15 to 50	max. 70	M10	113.0	106.6
54	T5	G5	1 x 54.0	ELXc 154.864	188142	220–240	A2 BAT	–15 to 55	max. 65	M10	59.0	101.1
2x54	T5	G5	2 x 54.0	ELXc 254.865	188618	220–240	A2 BAT	–15 to 50	max. 70	M10	119.0	106.0
80	T5	G5	1 x 80.0	ELXc 180.866	188144	220–240	A2 BAT	–15 to 55	max. 70	M10	87.0	97.6
2x80	T5	G5	2 x 80.0	ELXc 280.538	188619	220–240	A2 BAT	–15 to 50	max. 70	M11	175.0	97.2
For T8 lamps – Casing: M8												
3x18	T8	G13	3 x 16.0	ELXc 418.204	188744	220–240	A2 BAT	–15 to 55	max. 70	M8	56.0	100.8
4x18	T8	G13	4 x 16.0	ELXc 418.204	188744	220–240	A2 BAT	–15 to 55	max. 70	M8	71.5	98.9
3x36	T8	G13	3 x 32.0	ELXc 336.214	188595	220–240	A2 BAT	–15 to 50	max. 65	M8	105.0	99.4

Circuit diagrams see pages 220–223

ELXc EffectLine – Warm start

Warm start for T5 and T8 lamps – Casing: M6, M8 and M10

DC voltage

for operation: 176–264 V

for ignition: 198–264 V

(not possible for T8)

Push-in terminals with lever opener: 0.5–1.5 mm²

EOL shut down approved

acc. to EN 61347 Test 2 (for T5)

EOL shut down (for T8)

T5 TC BUILT-IN 1-10 V
 T8 INDEPENDENT DALI/PUSH

Lamp				Electronic ballast							System	
Output W	Type	Base	Power consumption W	Type	Ref. No.	Voltage AC 50, 60 Hz V±10%	Energy efficiency	Ambient temperature t _a (°C)	Casing temperature t _c (°C)	Casing	Output W	Luminous factor %

For T5 lamps – Casing: M6 and M10

14	T5	G5	1 x 14.3	ELXc 135.220	188921	220–240	A2 BAT	–15 to 55	max. 70	M6	17.0	104.8
2x14	T5	G5	2 x 14.3	ELXc 235.221	188922	220–240	A2 BAT	–15 to 55	max. 70	M10	34.5	101.9
21	T5	G5	1 x 20.4	ELXc 135.220	188921	220–240	A2 BAT	–15 to 55	max. 70	M6	23.3	106.9
2x21	T5	G5	2 x 21.4	ELXc 235.221	188922	220–240	A2 BAT	–15 to 55	max. 70	M10	48.3	104.9
28	T5	G5	1 x 26.7	ELXc 135.220	188921	220–240	A2 BAT	–15 to 55	max. 70	M6	29.9	107.5
2x28	T5	G5	2 x 28.7	ELXc 235.221	188922	220–240	A2 BAT	–15 to 55	max. 70	M10	62.1	109.0
35	T5	G5	1 x 32.6	ELXc 135.220	188921	220–240	A2 BAT	–15 to 55	max. 70	M6	36.5	103.0
2x35	T5	G5	2 x 35.6	ELXc 235.221	188922	220–240	A2 BAT	–15 to 55	max. 70	M10	78.2	100.8

For T8 lamps – Casing: M8

18	T8	G13	1 x 16.0	ELXc 136.207	188704	220–240	A2 BAT	–20 to 55	max. 60	M8	18.4	105.0
2x18	T8	G13	2 x 16.0	ELXc 236.208	188705	220–240	A2 BAT	–20 to 50	max. 60	M8	35.2	106.0
36	T8	G13	1 x 32.0	ELXc 136.207	188704	220–240	A2 BAT	–20 to 55	max. 60	M8	35.4	97.0
2x36	T8	G13	2 x 32.0	ELXc 236.208	188705	220–240	A2 BAT	–20 to 50	max. 60	M8	69.7	98.0
58	T8	G13	1 x 50.0	ELXc 158.209	188706	220–240	A2 BAT	–20 to 50	max. 60	M8	52.6	106.0
2x58	T8	G13	2 x 50.0	ELXc 258.210	188707	220–240	A2	–20 to 50	max. 65	M8	109.9	105.0

Circuit diagrams see pages 220–223

ELXc EffectLine II – Warm start

Warm start for T8 lamps – Casing: M8

DC voltage

for operation: 176–264 V

(DC voltage can be reduced to 176 V for 2 hours)

for ignition: 198–264 V

Push-in terminals with lever opener: 0.5–1.5 mm²

EOL 2 shut down

T5 TC BUILT-IN 1-10 V
 T8 INDEPENDENT DALI/PUSH

Lamp				Electronic ballast							System	
Output W	Type	Base	Power consumption W	Type	Ref. No.	Voltage AC 50, 60 Hz V±10%	Energy efficiency	Ambient temperature t _a (°C)	Casing temperature t _c (°C)	Casing	Output W	Luminous factor %
18	T8	G13	1 x 16.0	ELXc 136.216	188912	220–240	A2 BAT	–20 to 55	max. 65	M8	19.8	105.7
2x18	T8	G13	2 x 16.0	ELXc 236.217	188913	220–240	A2 BAT	–20 to 60	max. 70	M8	38.0	101.6
36	T8	G13	1 x 32.0	ELXc 136.216	188912	220–240	A2 BAT	–20 to 55	max. 65	M8	34.4	97.5
2x36	T8	G13	2 x 32.0	ELXc 236.217	188913	220–240	A2 BAT	–20 to 60	max. 70	M8	71.9	110.6
58	T8	G13	1 x 50.0	ELXc 158.218	188914	220–240	A2 BAT	–20 to 60	max. 65	M8	56.0	100.8
2x58	T8	G13	2 x 50.0	ELXc 258.219	188915	220–240	A2	–20 to 55	max. 70	M8	110.0	101.0

Circuit diagrams see pages 220–223

ELXc – Warm Start New T5 EffectLine

Electronic built-in ballasts

Casing: metal

Push-in terminals with lever opener: 0.5–1 mm²

RFI-suppressed

For luminaires of protection class I

Degree of protection: IP20

For lighting systems with
high switching frequency (> 5/day)

Automatic restart after lamp has been changed

Suitable for use in luminaires for emergency

lighting systems acc. to VDE 0108

EOL shut down approved acc. to EN 61347 Test 1

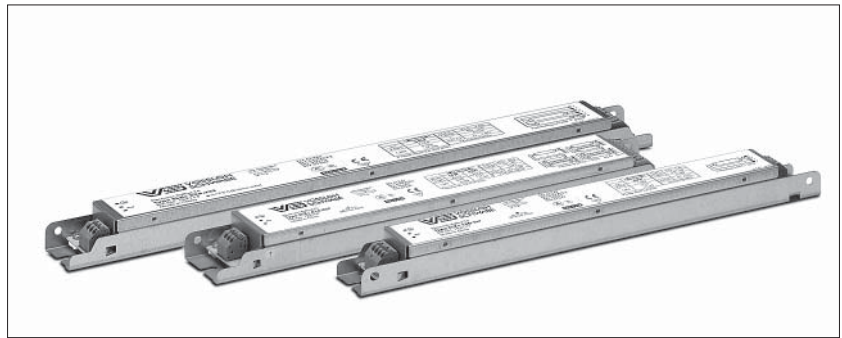

M7.1 / M10.2

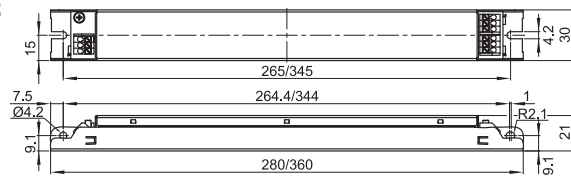

M7.2

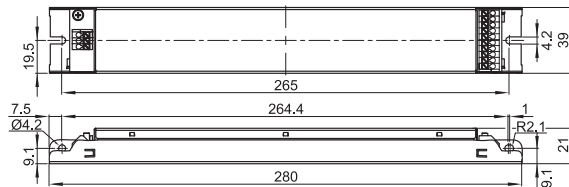

- T5 TC BUILT-IN 1-10 V
- T8 INDEPENDENT DALI/PUSH

Lamp				Electronic ballast										System	
Output W	Type	Base	Power consumption W	Type	Ref. No.	Voltage AC 50, 60 Hz V±10 %	Energy efficiency EEI=A2	Power factor > 0.90	Ambient temperature t _a (°C) 0 to 50	Casing temperature t _c (°C) max. 75	Casing	L mm	W mm	Output W	Luminous factor %
14	T5 HE	G5	1 x 14.0	ELXc 228.229	183111	220-240	EEI=A2	> 0.90	0 to 50	max. 75	M7.1	280	30	16,5	100
				ELXc 135.231	183113	220-240	EEI=A2	> 0.90	0 to 50	max. 75	M7.1	280	30	16,5	100
2x14	T5 HE	G5	2 x 14.0	ELXc 228.229	183111	220-240	EEI=A2	> 0.92	0 to 50	max. 75	M7.1	280	30	31,0	100
3x14	T5 HE	G5	3 x 14.0	ELXc 414.227	183109	220-240	EEI=A2	> 0.95	0 to 50	max. 75	M7.2	280	39	48,0	100
4x14	T5 HE	G5	4 x 14.0	ELXc 414.227	183109	220-240	EEI=A2	> 0.95	0 to 50	max. 75	M7.2	280	39	63,0	100
21	T5 HE	G5	1 x 21.0	ELXc 228.229	183111	220-240	EEI=A2	> 0.90	0 to 50	max. 75	M7.1	280	30	24,0	100
				ELXc 135.231	183113	220-240	EEI=A2	> 0.92	0 to 50	max. 75	M7.1	280	30	24,0	100
2x21	T5 HE	G5	2 x 21.0	ELXc 228.229	183111	220-240	EEI=A2	> 0.95	0 to 50	max. 75	M7.1	280	30	47,5	100
24	T5 HO	G5	1 x 24.0	ELXc 239.233	183115	220-240	EEI=A2	> 0.90	0 to 50	max. 75	M7.1	280	30	28,0	100
2x24	T5 HO	G5	2 x 24.0	ELXc 239.233	183115	220-240	EEI=A2	> 0.95	0 to 50	max. 75	M7.1	280	30	53,5	100
3x24	T5 HO	G5	3 x 24.0	ELXc 424.228	183110	220-240	EEI=A2	> 0.95	0 to 50	max. 75	M7.2	280	39	76,0	100
4x24	T5 HO	G5	4 x 24.0	ELXc 424.228	183110	220-240	EEI=A2	> 0.95	0 to 50	max. 75	M7.2	280	39	100,0	100
28	T5 HE	G5	1 x 28.0	ELXc 228.229	183111	220-240	EEI=A2	> 0.92	0 to 50	max. 75	M7.1	280	30	31,0	100
				ELXc 135.231	183113	220-240	EEI=A2	> 0.95	0 to 50	max. 75	M7.1	280	30	32,0	100
2x28	T5 HE	G5	2 x 28.0	ELXc 228.229	183111	220-240	EEI=A2	> 0.95	0 to 50	max. 75	M7.1	280	30	61,0	100
				ELXc 328.230	183112	220-240	EEI=A2	> 0.95	0 to 50	max. 75	M7.2	280	39	61,0	100
3x28	T5 HE	G5	3 x 28.0	ELXc 328.230	183112	220-240	EEI=A2	> 0.95	0 to 50	max. 75	M7.2	280	39	94,0	100
35	T5 HE	G5	1 x 35.0	ELXc 135.231	183113	220-240	EEI=A2	> 0.95	0 to 50	max. 75	M7.1	280	30	38,0	100
2x35	T5 HE	G5	2 x 35.0	ELXc 235.232	183114	220-240	EEI=A2	> 0.95	0 to 50	max. 75	M10.2	360	30	74,0	100
39	T5 HO	G5	1 x 39.0	ELXc 239.233	183115	220-240	EEI=A2	> 0.92	0 to 50	max. 75	M7.1	280	30	43,5	100
2x39	T5 HO	G5	2 x 39.0	ELXc 239.233	183115	220-240	EEI=A2	> 0.95	0 to 50	max. 75	M7.1	280	30	83,0	100
49	T5 HO	G5	1 x 49.0	ELXc 149.234	183116	220-240	EEI=A2	> 0.95	0 to 50	max. 75	M7.1	280	30	51,0	100
2x49	T5 HO	G5	2 x 49.0	ELXc 249.235	183117	220-240	EEI=A2	> 0.95	0 to 50	max. 75	M10.2	360	30	108,0	100
54	T5 HO	G5	1 x 54.0	ELXc 254.236	183118	220-240	EEI=A2	> 0.92	0 to 50	max. 75	M7.1	280	30	58,0	100
2x54	T5 HO	G5	2 x 54.0	ELXc 254.236	183118	220-240	EEI=A2	> 0.95	0 to 50	max. 75	M7.1	280	30	113,0	100
80	T5 HO	G5	1 x 80.0	ELXc 180.237	183119	220-240	EEI=A2	> 0.95	0 to 50	max. 75	M7.1	280	30	86,0	100

Preliminary data | Circuit diagrams see pages 220-223

ELXc – ECO EffectLine Warm Start for T5 and T8 Lamps

Electronic built-in ballasts

Casing: PC, white

Push-in terminals with lever opener: 0.5–1.5 mm²

RFI-suppressed

For luminaires of protection class I

Degree of protection: IP20

For lighting systems with

high switching frequency (> 5/day)

EOL shut down approved acc. to EN 61347 Test 1

(for T5 lamps); EOL shut down (for T8 lamps)

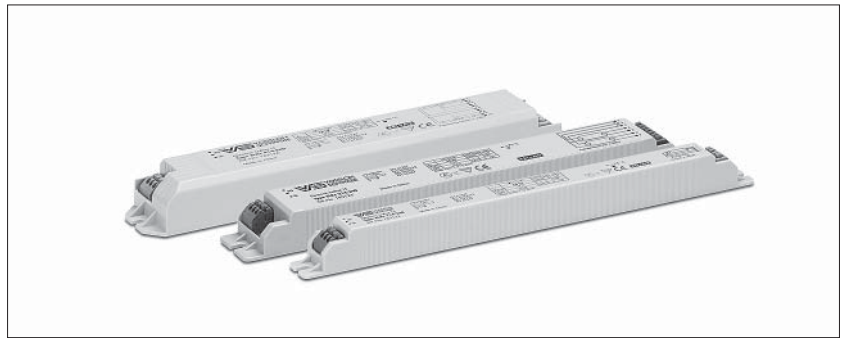

K7.1 / K7.2

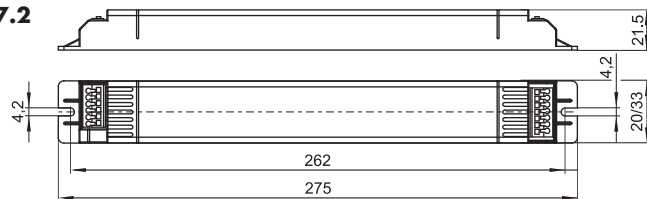

K5.1 / K5.2

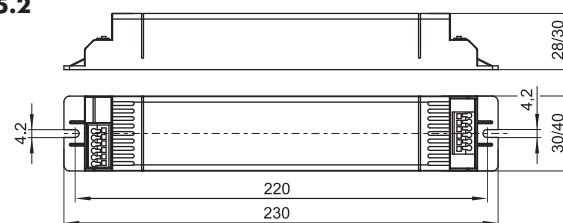

- T5 TC BUILT-IN 1-10 V
- T8 INDEPENDENT DALI/PUSH

Lamp				Electronic ballast										System	
Output W	Type	Base	Power consumption W	Type	Ref. No.	Voltage AC 50, 60 Hz V±10 %	Energy efficiency	Power factor	Ambient temperature t _a (°C)	Casing temperature t _c (°C)	Casing	W mm	H mm	Output W	Luminous factor %
For T5 lamps															
14	T5 HE	G5	1 x 14.8	ELXc 114.238	183122	220-240	A2	> 0.95	0 to 50	max. 75	K7.1	20	21.5	17.0	100
2x14	T5 HE	G5	2 x 14.5	ELXc 214.240	183124	220-240	A2	> 0.95	0 to 50	max. 75	K7.2	33	21.5	33.0	100
4x14	T5 HE	G5	4 x 14.0	ELXc 414.242	183126	220-240	A2	> 0.95	0 to 50	max. 75	K5.2	40	30	64.0	100
28	T5 HE	G5	1 x 28.5	ELXc 128.239	183123	220-240	A2	> 0.95	0 to 50	max. 75	K7.1	20	21.5	31.5	100
2x28	T5 HE	G5	2 x 26.5	ELXc 228.241	183125	220-240	A2	> 0.95	0 to 50	max. 75	K7.2	33	21.5	59.0	95
For T8 lamps															
18	T8	G13	1 x 15.5	ELXc 118.243	183127	220-240	A2	> 0.95	-15 to 50	max. 70	K5.1	30	28	18.5	98
2x18	T8	G13	2 x 15.5	ELXc 218.246	183130	220-240	A2	> 0.96	-15 to 50	max. 70	K5.1	30	28	35.0	98
4x18	T8	G13	4 x 15.5	ELXc 418.249	183133	220-240	A2	> 0.98	-15 to 50	max. 70	K5.2	40	30	69.0	97
36	T8	G13	1 x 30.5	ELXc 136.244	183128	220-240	A2	> 0.96	-15 to 50	max. 70	K5.1	30	28	34.0	95
2x36	T8	G13	2 x 31.0	ELXc 236.247	183131	220-240	A2	> 0.98	-15 to 50	max. 70	K5.2	40	30	68.0	97
58	T8	G13	1 x 48.0	ELXc 158.245	183129	220-240	A2	> 0.96	-15 to 50	max. 70	K5.1	30	28	53.5	96
2x58	T8	G13	2 x 49.5	ELXc 258.248	183132	220-240	A2	> 0.98	-15 to 50	max. 80	K5.2	40	30	107.0	100

Preliminary data | Circuit diagrams see pages 220–223

ELXd – Dimmable for M9 T5 and T8 Lamps

Electronic built-in ballasts

Casing: metal

Power factor: ≥ 0.95 at 100% operation

DC voltage

for operation: 154–276 V (M22, M23, M24)

for operation: 176–264 V (M9)

for ignition: 198–264 V

For the automatic luminaire wiring:

IDC terminals for leads H05V-U 0.5

RFI-suppressed

For luminaires of protection class I

Degree of protection: IP20

For lighting systems with

high switching frequency ($> 5/\text{day}$)

Suitable for use in luminaires for emergency

lighting systems acc. to VDE 0108

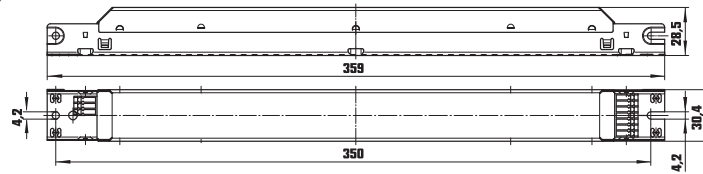

M10/M11

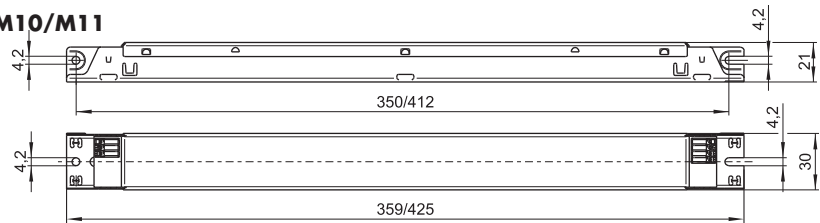

M23

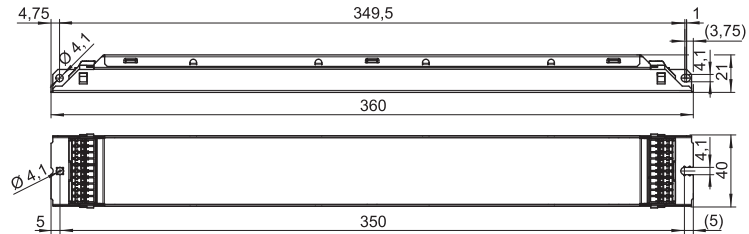

M22/M24

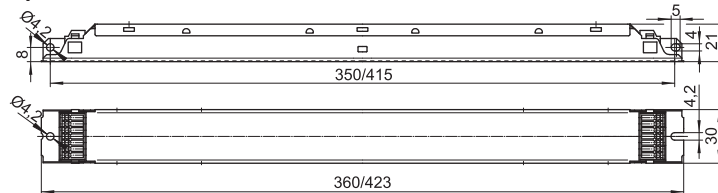

1

2

3

4

5

6

7

8

9

10

ELXd – Dimmable 1–10 V with lamp detection

Dimming range:

approx. 1–100% of lamp power

(*3–100 %: ELXd 135.823, 235.735, 118.718, 218.719, 136.720, 236.721, 158.722, 258.723)

Control voltage: DC 1–10 V acc. to EN 60929
with earth leakage current 0.5 mA
(protected if connected to mains voltage)

For use with open- or closed-loop control units

Push-in terminals: 0.5–1 mm²

EOL shut down approved

acc. to EN 61347 Test 2 (for T5)

EOL 2 shut down (for T8)

T5 TC BUILT-IN 1–10 V
 T8 INDEPENDENT DALI/PUSH

Lamp				Electronic ballast							System	
Output W	Type	Base	Power consumption W	Type	Ref. No.	Voltage AC 50, 60 Hz V±10%	Energy efficiency	Ambient temperature t _a (°C)	Casing temperature t _c (°C)	Casing	Output W	Luminous factor %
T5 lamps – Casing: M10, M22, M23 and M24												
14	T5	G5	1 x 14.0	ELXd 135.823	188717*	220–240	A1 BAT	10 to 55	max. 65	M10	17.0	99.5
				ELXd 124.607	188336	220–240	A1 BAT	10 to 50	max. 75	M22	16.0	100.0
2x14	T5	G5	2 x 13.6	ELXd 235.735	183059*	220–240	A1 BAT	10 to 50	max. 70	M11	33.4	98.7
			2 x 14.0	ELXd 224.608	188337	220–240	A1 BAT	10 to 50	max. 75	M24	31.0	100.0
3x14	T5	G5	3 x 14.0	ELXd 324.623	188597	220–240	A1 BAT	10 to 50	max. 75	M23	45.3	100.0
4x14	T5	G5	4 x 14.0	ELXd 424.624	188598	220–240	A1 BAT	10 to 50	max. 75	M23	60.4	100.0
21	T5	G5	1 x 21.0	ELXd 135.823	188717*	220–240	A1 BAT	10 to 55	max. 65	M10	24.0	99.0
				ELXd 139.609	188338	220–240	A1 BAT	10 to 50	max. 75	M22	23.0	100.0
2x21	T5	G5	2 x 20.5	ELXd 235.735	183059*	220–240	A1 BAT	10 to 50	max. 70	M11	47.0	95.1
			2 x 21.0	ELXd 239.610	188339	220–240	A1 BAT	10 to 50	max. 75	M24	45.0	100.0
24	T5	G5	1 x 23.0	ELXd 124.607	188336	220–240	A1 BAT	10 to 50	max. 75	M22	26.0	100.0
2x24	T5	G5	2 x 23.0	ELXd 224.608	188337	220–240	A1 BAT	10 to 50	max. 75	M24	50.0	100.0
3x24	T5	G5	3 x 23.0	ELXd 324.623	188597	220–240	A1 BAT	10 to 50	max. 75	M23	73.4	100.0
4x24	T5	G5	4 x 23.0	ELXd 424.624	188598	220–240	A1 BAT	10 to 50	max. 75	M23	97.6	100.0
28	T5	G5	1 x 28.0	ELXd 135.823	188717*	220–240	A1 BAT	10 to 55	max. 65	M10	32.0	98.6
				ELXd 154.611	188340	220–240	A1 BAT	10 to 50	max. 75	M22	31.0	100.0
2x28	T5	G5	2 x 27.3	ELXd 235.735	183059*	220–240	A1 BAT	10 to 50	max. 70	M11	62.1	97.6
			2 x 28.0	ELXd 254.612	188341	220–240	A1 BAT	10 to 50	max. 75	M24	61.0	100.0
35	T5	G5	1 x 35.0	ELXd 135.823	188717*	220–240	A1 BAT	10 to 55	max. 65	M10	38.0	95.0
				ELXd 180.613	188342	220–240	A1 BAT	10 to 50	max. 75	M22	38.0	100.0
2x35	T5	G5	2 x 33.9	ELXd 235.735	183059*	220–240	A1 BAT	10 to 50	max. 70	M11	76.9	96.7
			2 x 35.0	ELXd 249.614	188343	220–240	A1 BAT	10 to 50	max. 75	M24	75.0	100.0
				ELXd 280.630	188604	220–240	A1 BAT	10 to 50	max. 75	M24	75.0	100.0
39	T5	G5	1 x 38.0	ELXd 139.609	188338	220–240	A1 BAT	10 to 50	max. 75	M22	42.0	100.0
2x39	T5	G5	2 x 38.0	ELXd 239.610	188339	220–240	A1 BAT	10 to 50	max. 75	M24	82.0	100.0
49	T5	G5	1 x 49.0	ELXd 180.613	188342	220–240	A1 BAT	10 to 50	max. 75	M22	54.0	100.0
2x49	T5	G5	2 x 49.0	ELXd 249.614	188343	220–240	A1 BAT	10 to 50	max. 75	M24	104.0	100.0
				ELXd 280.630	188604	220–240	A1 BAT	10 to 50	max. 75	M24	104.0	100.0
54	T5	G5	1 x 54.0	ELXd 154.611	188340	220–240	A1 BAT	10 to 50	max. 75	M22	59.0	100.0
2x54	T5	G5	2 x 54.0	ELXd 254.612	188341	220–240	A1 BAT	10 to 50	max. 75	M24	115.0	100.0
80	T5	G5	1 x 80.0	ELXd 180.613	188342	220–240	A1 BAT	10 to 50	max. 75	M22	88.0	100.0
2x80	T5	G5	2 x 80.0	ELXd 280.630	188604	220–240	A1 BAT	10 to 50	max. 75	M24	165.0	100.0
T8 lamps – Casing: M9												
18	T8	G13	1 x 16.0	ELXd 118.718	188873*	220–240	EEI=A1	10 to 50	max. 70	M9	21.0	102.1
2x18	T8	G13	2 x 16.0	ELXd 218.719	188874*	220–240	EEI=A1	10 to 50	max. 70	M9	41.5	104.6
36	T8	G13	1 x 32.0	ELXd 136.720	188875*	220–240	A1 BAT	10 to 50	max. 70	M9	37.3	101.6
2x36	T8	G13	2 x 32.0	ELXd 236.721	188876*	220–240	EEI=A1	10 to 50	max. 70	M9	72.0	98.9
58	T8	G13	1 x 50.0	ELXd 158.722	188877*	220–240	A1 BAT	10 to 50	max. 70	M9	55.0	101.3
2x58	T8	G13	2 x 50.0	ELXd 258.723	188878*	220–240	EEI=A1	10 to 50	max. 75	M9	109.0	96.5

Circuit diagrams see pages 220–223

ELXd – Dimmable with push key or DALI with lamp detection

Dimming range:

approx. 1-100% of lamp power

PUSH: dimmable with usual push key

DALI: poles are not polarity sensitive
(protected if connected to mains voltage)
for use with DALI compatible control units

Push-in terminals: 0.5–1 mm²

EOL shut down approved

acc. to EN 61347 Test 2 (for T5)

EOL 2 shut down (for T8)

standby power consumption: ≤ 0.2 W

Complete implementation of the DALI-standard:

addressable, memory store for scenes and groups,

revertive information communication, physical and

RND-selection, standardized lamp characteristic

Low-power design ensures very low standby

power consumption

Compatible with IEC 62386

- T5 TC BUILT-IN 1-10 V
 T8 INDEPENDENT DALI/PUSH

Lamp				Electronic ballast							System	
Output W	Type	Base	Power consumption W	Type	Ref. No.	Voltage AC 50, 60 Hz V±10%	Energy efficiency	Ambient temperature t _a (°C)	Casing temperature t _c (°C)	Casing	Output W	Luminous factor %
For T5 lamps – Casing: M10, M11, M22, M23 and M24												
14	T5	G5	1 x 13.7	ELXd 135.724	188932	220–240	A1 BAT	10 to 50	max. 65	M10	16.4	102.6
			1 x 14.0	ELXd 124.600	188329	220–240	A1 BAT	10 to 50	max. 75	M22	16.0	100.0
2x14	T5	G5	2 x 13.6	ELXd 235.725	188933	220–240	A1 BAT	10 to 50	max. 70	M11	33.4	96.7
			2 x 14.0	ELXd 224.601	188330	220–240	A1 BAT	10 to 50	max. 75	M24	31.0	100.0
3x14	T5	G5	3 x 14.0	ELXd 324.626	188600	220–240	A1 BAT	10 to 50	max. 75	M23	45.3	100.0
4x14	T5	G5	4 x 14.0	ELXd 424.628	188602	220–240	A1 BAT	10 to 50	max. 75	M23	60.4	100.0
21	T5	G5	1 x 20.7	ELXd 135.724	188932	220–240	A1 BAT	10 to 50	max. 65	M10	24.3	102.7
			1 x 21.0	ELXd 139.602	188331	220–240	A1 BAT	10 to 50	max. 75	M22	23.0	100.0
2x21	T5	G5	2 x 20.5	ELXd 235.725	188933	220–240	A1 BAT	10 to 50	max. 70	M11	47.0	97.6
			2 x 21.0	ELXd 239.621	188350	220–240	A1 BAT	10 to 50	max. 75	M24	45.0	100.0
24	T5	G5	1 x 23.0	ELXd 124.600	188329	220–240	A1 BAT	10 to 50	max. 75	M22	26.0	100.0
2x24	T5	G5	2 x 23.0	ELXd 224.601	188330	220–240	A1 BAT	10 to 50	max. 75	M24	50.0	100.0
3x24	T5	G5	3 x 23.0	ELXd 324.626	188600	220–240	A1 BAT	10 to 50	max. 75	M23	73.4	100.0
4x24	T5	G5	4 x 23.0	ELXd 424.628	188602	220–240	A1 BAT	10 to 50	max. 75	M23	97.6	100.0
28	T5	G5	1 x 27.8	ELXd 135.724	188932	220–240	A1 BAT	10 to 50	max. 65	M10	32.0	104.1
			1 x 28.0	ELXd 154.603	188332	220–240	A1 BAT	10 to 50	max. 75	M22	31.0	100.0
2x28	T5	G5	2 x 27.3	ELXd 235.725	188933	220–240	A1 BAT	10 to 50	max. 70	M11	62.1	95.1
			2 x 28.0	ELXd 254.604	188333	220–240	A1 BAT	10 to 50	max. 75	M24	61.0	100.0
35	T5	G5	1 x 34.7	ELXd 135.724	188932	220–240	A1 BAT	10 to 50	max. 65	M10	40.0	107.5
			1 x 35.0	ELXd 180.605	188334	220–240	A1 BAT	10 to 50	max. 75	M22	38.0	100.0
2x35	T5	G5	2 x 33.9	ELXd 235.725	188933	220–240	A1 BAT	10 to 50	max. 70	M11	76.9	98.7
			2 x 35.0	ELXd 280.631	188605	220–240	A1 BAT	10 to 50	max. 75	M24	74.0	100.0
				ELXd 249.606	188335	220–240	A1 BAT	10 to 50	max. 75	M24	75.0	100.0
39	T5	G5	1 x 38.0	ELXd 139.602	188331	220–240	A1 BAT	10 to 50	max. 75	M22	42.0	100.0
2x39	T5	G5	2 x 38.0	ELXd 239.621	188350	220–240	A1 BAT	10 to 50	max. 75	M24	82.0	100.0
49	T5	G5	1 x 49.0	ELXd 180.605	188334	220–240	A1 BAT	10 to 50	max. 75	M22	54.0	100.0
2x49	T5	G5	2 x 49.0	ELXd 280.631	188605	220–240	A1 BAT	10 to 50	max. 75	M24	101.0	100.0
				ELXd 249.606	188335	220–240	A1 BAT	10 to 50	max. 75	M24	104.0	100.0
54	T5	G5	1 x 54.0	ELXd 154.603	188332	220–240	A1 BAT	10 to 50	max. 75	M22	59.0	100.0
2x54	T5	G5	2 x 54.0	ELXd 254.604	188333	220–240	A1 BAT	10 to 50	max. 75	M24	115.0	100.0
80	T5	G5	1 x 80.0	ELXd 180.605	188334	220–240	A1 BAT	10 to 50	max. 75	M22	88.0	100.0
2x80	T5	G5	2 x 80.0	ELXd 280.631	188605	220–240	A1 BAT	10 to 50	max. 75	M24	165.0	100.0

Circuit diagrams see pages 220–223

Accessories for Dimmable Electronic Ballasts

Manual controller

Dimmer for EB with low-voltage interface 1–10 V

Dimensions: 67x67x51 mm

Push-button change-over switch with stud 4 mm for installation in flush-type boxes with \varnothing 55 mm

Max. 50 EBs per dimmer

Weight: 60/30 g, unit: 25 pcs.

Without cover plate

Ref. No.: 172778

Cover plate with rotary knob

Dimensions: 80x80x9 mm

Ref. No.: 172775 white

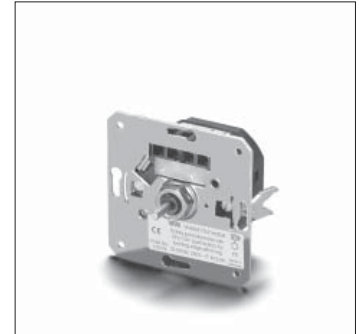
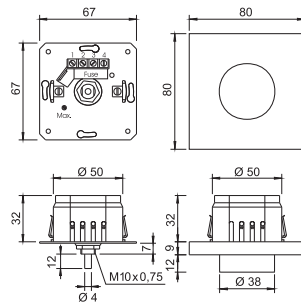

Light sensor

Constant light control with clamp fastening for fluorescent lamps T8 (T26) and compact fluorescent lamps

Dimensions: 33.5x40x96 mm

With connection lead: 2x0.24 mm²

Length: 800 mm

Max. 50 EBs per light sensor

Weight: 55 g, unit: 60 pcs.

Ref. No.: 172776

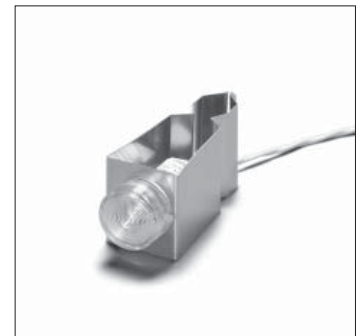
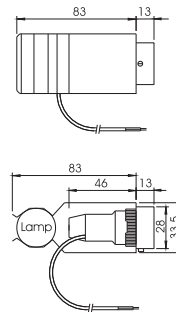

Multi sensor

Dimensions: 58.5x70.5x42 mm

With the sensor the lighting can be kept on a pre-defined level

With integrated motion detector

Max. 50 EBs per multi sensor

Weight: 125 g, unit: 25 pcs.

Ref. No.: 172777

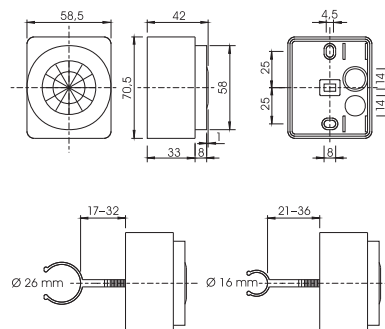

1

2

3

4

5

6

7

8

9

10

RELIABLE AND
DURABLE

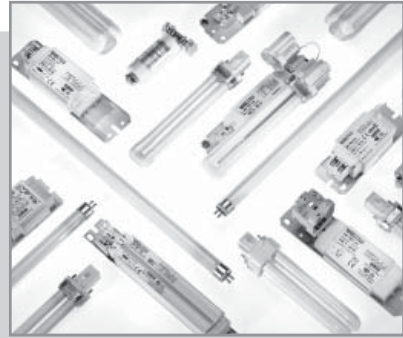

ELECTROMAGNETIC BALLASTS

The following chapter presents Vossloh-Schwabe's broad range of electromagnetic ballasts for compact fluorescent lamps and tubular fluorescent lamps. The variety of available performance properties and shapes satisfies the most diverse design requirements.

Vossloh-Schwabe's electromagnetic ballasts are characterized by extremely tight impedance-value tolerances, which are achieved by individual adjustment of the air gap during the automated production and testing process of the ballasts. This optimises both light output as well as the service life of fluorescent lamps.



3

Electromagnetic Ballasts for TC and T Lamps

Electromagnetic ballasts for compact fluorescent lamps

Standard ballasts

148–151

148–151

Electromagnetic ballasts for tubular fluorescent lamps

Super low-loss ballasts

Standard ballasts

152–155

152

153–155

Technical details for fluorescent lamps

General technical details

Glossary

208–235

348–356

357–359

1

2

3

4

5

6

7

8

9

10

Standard Ballasts 5–16 W, 230/240/220 V

For compact fluorescent lamps
Shape: 28x41 mm

Vacuum-impregnated with polyester resin

Push-in terminal for leads: 0.5–1 mm²

For the automatic luminaire wiring:

IDC terminals for leads H05V-U 0.5

tw 130

Protection class I

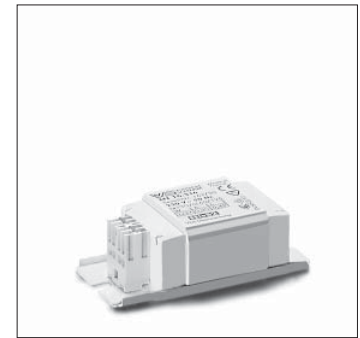
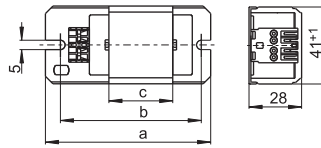

Lamp				Ballast										Capacitor	
Output	Type	Base	Current	Type	Ref. No.	Voltage	a	b	c	Weight	$\Delta t/\Delta t_{on}$	Energy efficiency	C _p	Current	
W			mA			V, Hz	mm	mm	mm	kg	K		μF	mA	
230 V, 50 Hz															
5	TC-S	G23	180	L7/9/11.307*	163694	230, 50	85	75	34	0.32	60/85	B2	2.0	50	
2x5	TC-S	G23	180	LN 13.805*	169647	230, 50	85	75	34	0.32	50/85	B1	2.0	70	
				LN 13.313*	163711	230, 50	85	75	34	0.32	55/80	B2	2.0	70	
7	TC-S	G23	175	L7/9/11.307*	163694	230, 50	85	75	34	0.32	60/85	B2	2.0	50	
2x7	TC-S	G23	160	LNN 13.044	564190	230, 50	155	140	92	0.80	25/40	A2	2.0	80	
				LN 13.805*	169647	230, 50	85	75	34	0.32	50/85	B1	2.0	70	
				LN 13.313*	163711	230, 50	85	75	34	0.32	55/80	B2	2.0	70	
9	TC-S	G23	170	LNN 9/11.015	562658	230, 50	155	140	92	0.80	15/40	A2	2.0	60	
				L7/9/11.307*	163694	230, 50	85	75	34	0.32	60/85	B1	2.0	60	
2x9	TC-S	G23	140	LNN 13.044	564190	230, 50	155	140	92	0.80	25/40	A2	2.0	80	
				LN 13.805*	169647	230, 50	85	75	34	0.32	50/85	B1	2.0	70	
				LN 13.313*	163711	230, 50	85	75	34	0.32	55/80	B2	2.0	80	
10	TC-D	G24d-1	190	LN 13.805*	169647	230, 50	85	75	34	0.32	50/85	B1	2.0	70	
				LN 13.313*	163711	230, 50	85	75	34	0.32	55/80	B2	2.0	70	
	TC-DD	GR10q	180	LN 13.805*	169647	230, 50	85	75	34	0.32	50/85	B1	2.0	70	
				LN 13.313*	163711	230, 50	85	75	34	0.32	55/80	B2	2.0	70	
11	TC-S	G23	155	LNN 9/11.015	562658	230, 50	155	140	92	0.80	15/40	A2	2.0	60	
				L7/9/11.307*	163694	230, 50	85	75	34	0.32	60/85	B1	2.0	80	
13	TC-D/TC-T	G24d-1/GX24d-1	175	LNN 13.044	564190	230, 50	155	140	92	0.80	25/40	A2	2.0	80	
				LN 13.805*	169647	230, 50	85	75	34	0.32	50/85	B1	2.0	80	
				LN 13.313*	163711	230, 50	85	75	34	0.32	55/80	B2	2.0	80	
16	TC-DD	GR8/GR10q	195	LN 16.316*	163730	230, 50	85	75	34	0.32	60/125	B1	2.0	100	
240 V, 50 Hz															
5	TC-S	G23	180	L7/9/11.411	164335	240, 50	85	75	34	0.32	60/85	B2	2.0	50	
2x5	TC-S	G23	180	LN 13.413	164342	240, 50	85	75	34	0.32	60/90	B2	2.0	70	
7	TC-S	G23	175	L7/9/11.411	164335	240, 50	85	75	34	0.32	60/85	B2	2.0	50	
2x7	TC-S	G23	160	LN 13.413	164342	240, 50	85	75	34	0.32	60/90	B2	2.0	70	
9	TC-S	G23	170	L7/9/11.411	164335	240, 50	85	75	34	0.32	60/85	B1	2.0	60	
2x9	TC-S	G23	140	LN 13.413	164342	240, 50	85	75	34	0.32	60/90	B2	2.0	80	
10	TC-D	G24d-1	190	LN 13.413	164342	240, 50	85	75	34	0.32	60/90	B2	2.0	70	
				TC-DD	GR10q	180	LN 13.413	164342	240, 50	85	75	34	0.32	60/90	B2
11	TC-S	G23	155	L7/9/11.411	164335	240, 50	85	75	34	0.32	60/85	B1	2.0	80	
13	TC-D/TC-T	G24d-1/GX24d-1	175	LN 13.413	164342	240, 50	85	75	34	0.32	60/90	B1	2.0	80	
16	TC-DD	GR8/GR10q	195	LN 16.417	164358	240, 50	85	75	34	0.32	60/130	B1	2.0	100	

* Ballasts without CE marking for replacements or markets outside of the EU

Standard Ballasts 5–16 W, 230/240/220 V

Lamp				Ballast									Capacitor	
Output	Type	Base	Current	Type	Ref. No.	Voltage	a	b	c	Weight	$\Delta t/\Delta t_{on}$	Energy efficiency	C _P	Current
W			mA			V, Hz	mm	mm	mm	kg	K		μF	mA
220 V, 60 Hz														
5	TC-S	G23	180	L 7/9/11.207	163305	220, 60	85	75	34	0.32	35/65	—	2.0	70
2x5	TC-S	G23	180	L 13.210	520992	220, 60	85	75	34	0.32	45/80	—	2.0	90
7	TC-S	G23	175	L 7/9/11.207	163305	220, 60	85	75	34	0.32	35/65	—	2.0	70
2x7	TC-S	G23	160	L 13.210	520992	220, 60	85	75	34	0.32	45/80	—	2.0	90
9	TC-S	G23	170	L 7/9/11.207	163305	220, 60	85	75	34	0.32	35/65	—	2.0	70
2x9	TC-S	G23	140	L 13.210	520992	220, 60	85	75	34	0.32	45/80	—	2.0	90
10	TC-D	G24d-1	190	L 13.210	520992	220, 60	85	75	34	0.32	45/80	—	2.0	80
	TC-DD	GR10q	180	L 13.210	520992	220, 60	85	75	34	0.32	45/80	—	2.0	80
11	TC-S	G23	155	L 7/9/11.207	163305	220, 60	85	75	34	0.32	35/65	—	2.0	80
13	TC-D/TC-T	G24d-1/GX24d-1	165	L 13.210	520992	220, 60	85	75	34	0.32	45/80	—	2.0	110

Standard Ballasts 18–58 W 230/240/220 V

For compact fluorescent lamps
Shape: 28x41 mm

Vacuum-impregnated with polyester resin

Push-in terminal for leads: 0.5–1 mm²

For the automatic luminaire wiring:

IDC terminals for leads H05V-U 0.5

tw 130

Protection class I

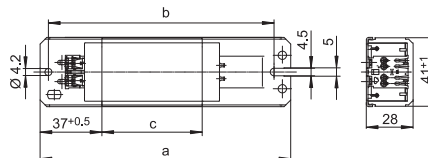
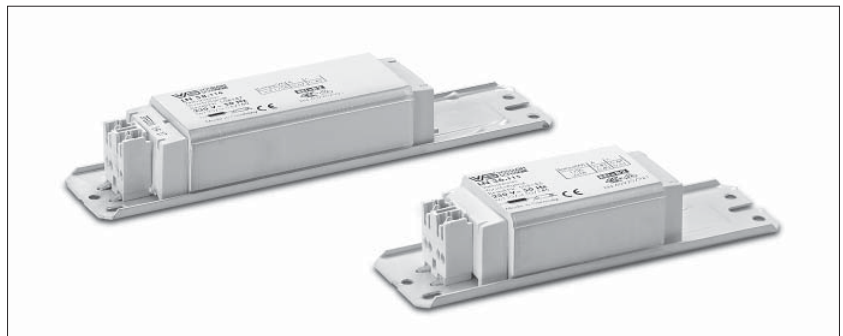

Lamp				Ballast									Capacitor	
Output	Type	Base	Current	Type	Ref. No.	Voltage	a	b	c	Weight	$\Delta t/\Delta t_{on}$	Energy efficiency	C _P	Current
W			mA			V, Hz	mm	mm	mm	kg	K		μF	mA
230 V, 50 Hz														
18	TC-D/TC-T	G24d-2/GX24d-2	220	INN 181.046	564192	230, 50	232.5	220	160	1.35	15/30	A2	2.0	110
				LN 181.940*	508922	230, 50	85	75	34	0.32	50/120	B1	2.0	110
				LN 181.319*	163763	230, 50	85	75	34	0.32	60/140	B1	2.0	110
	TC-F/TCL	2G10/2G11	370	LN 18.510*	164572	230, 50	155	140	92	0.80	40/65	B1	4.5	120
				LN 18.131*	530941	230, 50	150	140	60	0.55	55/95	B2	4.5	120
				L 18.934*	534621	230, 50	150	140	45	0.43	70/150	—	4.5	120
T-U	2G13	370	LN 18.131*	530941	230, 50	150	140	60	0.55	55/95	B2	4.5	120	
			L 18.934*	534621	230, 50	150	140	45	0.43	70/150	—	4.5	120	
2x18	TC-F/TCL	2G10/2G11	400	INN 2X18.043	564189	230, 50	150	135	60	0.55	40/160	A2	4.0	210
				LN 2x18.135*	532155	230, 50	150	140	45	0.43	65	B1	4.0	210
22	TR	G10q	400	LN 30.530*	164680	230, 50	155	140	92	0.80	45/65	B2	4.5	200
24	TC-F/TCL	2G10/2G11	345	LN 24/26.804*	534490	230, 50	150	140	60	0.55	55/110	B2	4.5	150
				L 18.934*	534621	230, 50	150	140	45	0.43	70/150	—	4.5	150

* Ballasts without CE marking for replacements or markets outside of the EU

Standard Ballasts 18–58 W, 230/240/220 V

Lamp				Ballast									Capacitor				
Output	Type	Base	Current	Type	Ref. No.	Voltage	a	b	c	Weight	$\Delta t / \Delta t_{an}$	Energy efficiency	C _p	Current			
W			mA			V, Hz	mm	mm	mm	kg	K		μF	mA			
230 V, 50 Hz																	
26	TC-D/TC-T	G24d-3/GX24d-3	325	LN 18.131*	530941	230, 50	150	140	60	0.55	55/95	B1	3.5	140			
				LN 26.813*	509502	230, 50	110	100	45	0.41	55/145	B2	3.5	140			
				L 18.934*	534621	230, 50	150	140	45	0.43	70/150	—	3.5	140			
28	TC-DD	GR8/GR10q	320	LN 18.510*	164572	230, 50	155	140	92	0.80	40/65	B1	3.5	150			
				LN 18.131*	530941	230, 50	150	140	60	0.55	55/95	B1	3.5	150			
				L 18.934*	534621	230, 50	150	140	45	0.43	70/150	—	3.5	150			
32	TR	G10q	450	LN 36.570*	169779	230, 50	155	140	92	0.80	35/90	B2	4.0	220			
36	TC-F/TC-L	2G10/2G11	430	LN 36.570*	169779	230, 50	155	140	92	0.80	35/90	B1	4.5	210			
				LN 36.511*	164590	230, 50	155	140	92	0.80	35/95	B1	4.5	210			
				LN 36.130*	527191	230, 50	150	140	60	0.55	50/140	B2	4.5	210			
				LN 36.149*	529029	230, 50	150	140	60	0.55	55/150	B2	4.5	210			
				L 36.132*	535977	230, 50	150	140	45	0.43	65	—	4.5	210			
36/40	T-U/TR	2G13/G10q	430	LN 36.570*	169779	230, 50	150	140	92	0.80	35/90	B1	4.5	210			
				LN 36.149*	529029	230, 50	150	140	60	0.55	55/150	B2	4.5	210			
				L 36.132*	535977	230, 50	150	140	45	0.43	65	—	4.5	210			
38	TC-DD	GR10q	430	LN 36.570*	169779	230, 50	155	140	92	0.80	35/90	B1	4.5	210			
				LN 36.149*	529029	230, 50	150	140	60	0.55	55/150	B2	4.5	210			
				L 36.132*	535977	230, 50	150	140	45	0.43	65	—	4.5	210			
58	T-U	2G13	670	LN 58.568*	169389	230, 50	233	220	160	1.31	35/95	B1	7.0	320			
				LN 58.990*	509349	230, 50	190	180	110	0.95	50/130	B2	7.0	320			
				LN 58.116*	508186	230, 50	190	180	92	0.80	55/160	B2	7.0	320			
240 V, 50 Hz																	
18	TC-D/TC-T	G24d-2/GX24d-2	220	LN 18.418	164353	240, 50	85	75	34	0.28	60/130	B1	2.0	110			
				TC-F/TC-L	2G10/2G11	370	LN 18.507	164566	240, 50	155	140	92	0.80	35/60	B1	4.5	120
							LN 18.162	533043	240, 50	150	140	60	0.55	60/110	B2	4.5	120
	T-U	2G13	370	L 18.936*	534627	240, 50	150	140	45	0.43	70/140	—	4.5	120			
				LN 18.507	164566	240, 50	155	140	92	0.80	35/60	B1	4.5	120			
				LN 18.162	533043	240, 50	150	140	60	0.55	60/110	B2	4.5	120			
2x18	TC-F/TC-L	2G10/2G11	400	L 18.936*	534627	240, 50	150	140	45	0.43	70/140	—	4.5	120			
				LN 2x18.135	535778	240, 50	150	140	45	0.43	65	B1	4.0	210			
				LN 36.201	527196	240, 50	150	140	60	0.55	55/140	B1	4.0	210			
21	TC-DD	GR10q	260	LN 36.505	164555	240, 50	155	140	92	0.80	40/95	B1	4.0	210			
				LN 21.293	547145	240, 50	105	95	45	0.41	55	B1	3.0	120			
				LN 18.507	164566	240, 50	155	140	92	0.80	35/60	B1	4.5	150			
24	TC-F/TC-L	2G10/2G11	345	LN 18.162	533043	240, 50	150	140	60	0.55	60/110	B2	4.5	150			
				L 18.936*	534627	240, 50	150	140	45	0.43	70/140	—	4.5	150			
				LN 18.162	533043	240, 50	150	140	60	0.55	60/110	B1	4.5	150			
26	TC-D/TC-T	G24d-3/GX24d-3	325	LN 26.238	545405	240, 50	105	95	45	0.41	55/145	B2	3.5	140			
				LN 18.162	533043	240, 50	150	140	60	0.55	60/110	B1	4.5	150			
28	TC-DD	GR8/GR10q	320	LN 18.162	533043	240, 50	150	140	60	0.55	60/110	B1	3.5	150			
				L 18.936*	534627	240, 50	150	140	45	0.43	70/140	—	3.5	150			
32	TR	G10q	450	LN 36.505	164555	240, 50	155	140	92	0.80	40/95	B1	4.0	220			
36	TC-F/TC-L	2G10/2G11	430	LN 36.505	164555	240, 50	155	140	92	0.80	40/95	B1	4.5	210			
				LN 36.201	527196	240, 50	155	140	60	0.55	55/140	B2	4.5	210			
				L 36/40.443*	164438	240, 50	150	140	60	0.55	65/155	—	4.5	210			
36/40	T-U/TR	2G13/G10q	430	LN 36.505	164555	240, 50	155	140	92	0.80	40/95	B1	4.5	210			
				LN 36.201	527196	240, 50	150	140	60	0.55	55/140	B2	4.5	210			
				L 36/40.443*	164438	240, 50	150	140	60	0.55	65/155	—	4.5	210			
38	TC-DD	GR10q	430	LN 36.201	527196	240, 50	150	140	60	0.55	55/140	B2	4.5	210			
				L 36/40.443*	164438	240, 50	150	140	60	0.55	65/155	—	4.5	210			
58	T-U	2G13	670	LN 58.506	164560	240, 50	233	220	160	1.31	35/85	B1	7.0	320			
				LN 58.192	507936	240, 50	190	180	110	0.95	50/150	B2	7.0	320			
				LN 58.722	534252	240, 50	190	180	92	0.80	60/180	B2	7.0	320			

* Ballasts without CE marking for replacements or markets outside of the EU

Standard Ballasts 18–58 W, 230/240/220 V

Lamp				Ballast									Capacitor	
Output	Type	Base	Current	Type	Ref. No.	Voltage	a	b	c	Weight	$\Delta t/\Delta t_{an}$	Energy efficiency	C _p	Current
W			mA			V, Hz	mm	mm	mm	kg	K		μF	mA
220 V, 50 Hz														
18	TC-F/TC-L	2G10/2G11	370	L18.933	534624	220,50	150	140	45	0.43	70/160	—	4.5	120
	T-U	2G13	370	L18.933	534624	220,50	150	140	45	0.43	70/160	—	4.5	120
2x18	TC-F/TC-L	2G10/2G11	400	L 36.158	530252	220,50	150	140	45	0.43	65	—	4.0	210
24	TC-F/TC-L	2G10/2G11	345	L18.933	534624	220,50	150	140	45	0.43	70/160	—	4.5	150
26	TC-D/TC-T	G24d-3/GX24d-3	325	L18.933	534624	220,50	150	140	45	0.43	70/160	—	3.5	140
28	TC-DD	GR8/GR10q	320	L18.933	534624	220,50	150	140	45	0.43	70/160	—	3.5	150
36	TC-F/TC-L	2G10/2G11	430	L 36.158	530252	220,50	150	140	45	0.43	65	—	4.5	210
36/40	T-U/TR	2G13/G10q	430	L 36.158	530252	220,50	150	140	45	0.43	65	—	4.5	210
38	TC-DD	GR10q	430	L 36.158	530252	220,50	150	140	45	0.43	65	—	4.5	210
58	T-U	2G13	670	L 58.625	164828	220,50	190	180	92	0.80	55/155	—	7.0	320
220 V, 60 Hz														
18	TC-D/TC-T	G24d-2/GX24d-2	220	L 181.602	164779	220, 60	85	75	34	0.32	45/110	—	2.0	110
	TC-F/TC-L	2G10/2G11	370	L 18.121	532149	220, 60	110	100	45	0.42	65/145	—	4.0	150
L 18.121				528582	220, 60	150	140	45	0.43	65/145	—	4.0	150	
L 18.249				538801	220, 60	150	140	34	0.32	75/140	—	4.0	150	
T-U	2G13	370	L 18.121	532149	220, 60	110	100	45	0.42	65/145	—	4.0	150	
			L 18.121	528582	220, 60	150	140	45	0.43	65/145	—	4.0	150	
			L 18.249	538801	220, 60	150	140	34	0.32	75/140	—	4.0	150	
2x18	TC-F/TC-L	2G10/2G11	400	L 36.120	509373	220, 60	150	140	45	0.43	60/170	—	4.0	210
24	TC-F/TC-L	2G10/2G11	345	L 18.121	532149	220, 60	110	100	45	0.42	65/145	—	4.0	190
				L 18.121	528582	220, 60	150	140	45	0.43	65/145	—	4.0	190
				L 18.249	538801	220, 60	150	140	34	0.32	75/140	—	4.0	190
26	TC-D/TC-T	G24d-3/GX24d-3	325	L 18.121	532149	220, 60	110	100	45	0.42	65/145	—	3.0	160
				L 18.121	528582	220, 60	150	140	45	0.43	65/145	—	3.0	160
				L 18.249	538801	220, 60	150	140	34	0.32	75/140	—	3.0	160
28	TC-DD	GR8/GR10q	320	L 18.121	532149	220, 60	110	100	45	0.42	65/145	—	3.0	155
				L 18.249	538801	220, 60	150	140	34	0.32	75/140	—	3.0	155
36	TC-F/TC-L	2G10/2G11	430	L 36.120	509373	220, 60	150	140	45	0.43	60/170	—	4.0	210
36/40	T-U/TR	2G13/G10q	430	L 36.120	509373	220, 60	150	140	45	0.43	60/170	—	4.0	220
38	TC-DD	GR10q	430	L 36.120	509373	220, 60	150	140	45	0.43	60/170	—	4.0	220
58	T-U	2G13	670	L 58.657	164870	220, 60	195	180	92	0.80	55/140	—	6.0	320

1

2

3

4

5

6

7

8

9

10

Super Low-loss Ballasts 18–65 W, 230 V

For fluorescent lamps
Shape: 28x41 mm / 53x66 mm

Vacuum-impregnated with polyester resin
Push-in terminal for leads: 0.5–1 mm²
tw 130

Protection class I

**Energy efficiency: A2,
minimum EU energy efficiency
requirements as of 2017**



A 53x66 mm

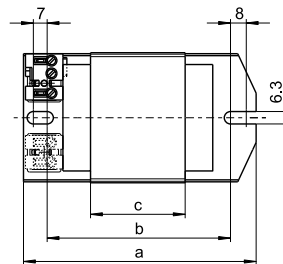

B 28x41 mm

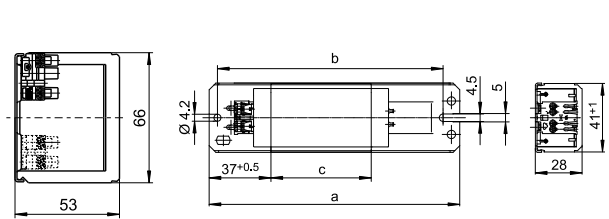

Lamp				Ballast										Capacitor	
Output W	Type	Base	Current mA	Type	Ref. No.	Voltage V, Hz	Draw- ing	a mm	b mm	c mm	Weight kg	$\Delta t/\Delta t_{an.}$ K	Energy efficiency	C _p μ F	Current mA
230 V, 50 Hz															
2x8	T5 (T16)	G5	155	INN 13.044	564190	230, 50	B	155	140	92	0.80	25/40	A2	2.0	80
13	T5 (T16)	G5	165	INN 13.044	564190	230, 50	B	155	140	92	0.80	25/40	A2	2.0	80
2x15	T8 (T26)	G13	340	INN 30.045	564191	230, 50	B	232.5	220	160	1.35	25/40	A2	4.0	185
18/20	T8 (T26)/T12 (T38)	G13	370	INN 18.645	560657	230, 50	A	130	105	64	1.80	10/20	A2	4.5	120
2x18/20	T8 (T26)/T12 (T38)	G13	400	INN 36.646	560659	230, 50	A	108	90	36	1.10	25/70	A2	4.0	210
				INN 2X18.043	564189	230, 50	B	150	135	60	0.55	40/160	A2	4.0	210
				INN 36.648	560664	230, 50	B	232.5	220	160	1.35	25/40	A2	4.5	210
30	T8 (T26)	G13	365	INN 30.045	564191	230, 50	B	232.5	220	160	1.35	25/40	A2	4.5	180
36/40	T8 (T26)/T12 (T38)	G13	430	INN 36.646	560659	230, 50	A	108	90	36	1.10	25/70	A2	4.0	120
				INN 36.648	560664	230, 50	B	232.5	220	160	1.35	25/40	A2	4.5	210
58/65	T8 (T26)/T12 (T38)	G13	670	INN 58.647	560661	230, 50	A	108	90	36	1.10	30/110	A2	7.0	320
				INN 58TD.649*	560665	230, 50	B	232.5	220	160	1.35	20/40	A2	7.0	320

* TD = halfchoke (two ballasts per lamp are necessary)

Standard Ballasts 4–13 W 230/240/220 V

For fluorescent lamps
Shape: 28x41 mm

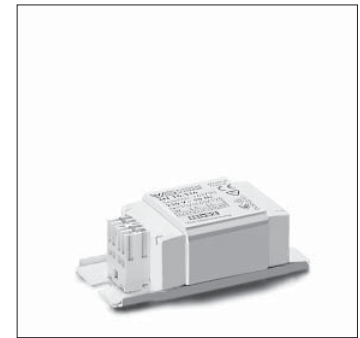
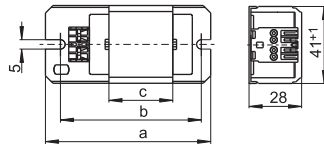

Vacuum-impregnated with polyester resin
Push-in terminal for leads: 0.5–1 mm²
For the automatic luminaire wiring:
IDC terminals for leads H05V-U 0.5
tw 130
Protection class I

Lamp				Ballast										Capacitor	
Output	Type	Base	Current	Type	Ref. No.	Voltage	a	b	c	Weight	Δt/Δtan.	Energy efficiency	C _p	Current	
W			mA			V, Hz	mm	mm	mm	kg	K		μF	mA	
230 V, 50 Hz															
4	T5 (T16)	G5	170	L4/6/8.304*	163683	230, 50	85	75	34	0.32	55/85	B2	2.0	40	
2x4	T5 (T16)	G5	155	L4/6/8.304*	163683	230, 50	85	75	34	0.32	55/85	B1	2.0	50	
6	T5 (T16)	G5	160	L4/6/8.304*	163683	230, 50	85	75	34	0.32	55/85	B1	2.0	50	
2x6	T5 (T16)	G5	175	LN 13.313*	163711	230, 50	85	75	34	0.32	55/80	B1	2.0	65	
8	T5 (T16)	G5	145	L4/6/8.304*	163683	230, 50	85	75	34	0.32	55/85	B1	2.0	60	
2x8	T5 (T16)	G5	155	LN 13.044	564190	230, 50	155	140	92	0.80	25/40	A2	2.0	80	
				LN 13.313*	163711	230, 50	85	75	34	0.32	55/80	B1	2.0	85	
13	T5 (T16)	G5	165	LN 13.044	564190	230, 50	155	140	92	0.80	25/40	A2	2.0	80	
				LN 13.313*	163711	230, 50	85	75	34	0.32	55/80	B1	2.0	80	
240 V, 50 Hz															
4	T5 (T16)	G5	170	L4/6/8.404	164326	240, 50	85	75	34	0.32	55/80	B2	2.0	40	
2x4	T5 (T16)	G5	155	L4/6/8.404	164326	240, 50	85	75	34	0.32	55/80	B1	2.0	50	
6	T5 (T16)	G5	160	L4/6/8.404	164326	240, 50	85	75	34	0.32	55/80	B1	2.0	50	
2x6	T5 (T16)	G5	175	LN 13.413	164342	240, 50	85	75	34	0.32	60/90	B1	2.0	65	
8	T5 (T16)	G5	145	L4/6/8.404	164326	240, 50	85	75	34	0.32	55/80	B1	2.0	60	
2x8	T5 (T16)	G5	155	LN 13.413	164342	240, 50	85	75	34	0.32	60/90	B1	2.0	85	
13	T5 (T16)	G5	165	LN 13.413	164342	240, 50	85	75	34	0.32	60/90	B1	2.0	80	
220 V, 60 Hz															
4	T5 (T16)	G5	170	L4/6/8.218	532644	220, 60	85	75	34	0.32	60/80	—	2.0	40	
2x4	T5 (T16)	G5	155	L4/6/8.218	532644	220, 60	85	75	34	0.32	60/80	—	2.0	50	
6	T5 (T16)	G5	160	L4/6/8.218	532644	220, 60	85	75	34	0.32	60/80	—	2.0	50	
2x6	T5 (T16)	G5	175	L13.210	520992	220, 60	85	75	34	0.32	45/80	—	2.0	65	
8	T5 (T16)	G5	145	L4/6/8.218	532644	220, 60	85	75	34	0.32	60/80	—	2.0	60	
2x8	T5 (T16)	G5	155	L13.210	520992	220, 60	85	75	34	0.32	45/80	—	2.0	85	
13	T5 (T16)	G5	165	L13.210	520992	220, 60	85	75	34	0.32	45/80	—	2.0	80	

* Ballasts without CE marking for replacements or markets outside of the EU

Standard Ballasts 14–65 W, 230 V

For fluorescent lamps
Shape: 28x41 mm

Vacuum-impregnated with polyester resin

Push-in terminal for leads: 0.5–1 mm²

For the automatic luminaire wiring:

IDC terminals for leads H05V-U 0.5

tw 130

Protection class I

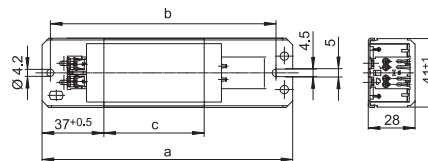
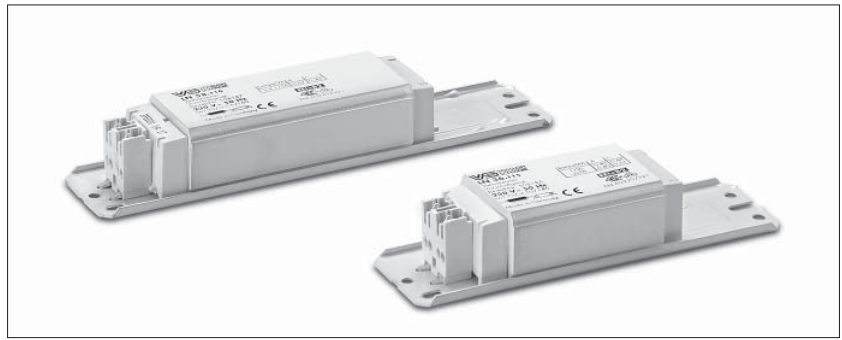

Lamp				Ballast										Capacitor	
Output	Type	Base	Current	Type	Ref. No.	Voltage	a	b	c	Weight	Δt/ΔI _{an.}	Energy efficiency	C _p	Current	
W			mA			V, Hz	mm	mm	mm	kg	K		μF	mA	
230 V, 50 Hz															
14	T8 (T26)	G13	395	LN 18.510*	164572	230, 50	155	140	92	0.80	40/65	B2	4.5	150	
15	T8 (T26)	G13	310	LN 15.329*	163861	230, 50	150	140	60	0.55	50/80	B2	3.5	120	
2x15	T8 (T26)	G13	340	INN 30.045	564191	230, 50	232.5	220	160	1.35	25/40	A2	4.0	185	
				LN 30.801*	169645	230, 50	150	140	60	0.55	55/110	B2	4.0	185	
				L 30.347*	164033	230, 50	150	140	60	0.55	60/150	—	4.0	185	
16	T8 (T26)	G13	200	LN 16.316*	163730	230, 50	85	75	34	0.32	60/125	B1	2.0	90	
18/20	T8 (T26)/T12 (T38)	G13	370	LN 18.510*	164572	230, 50	155	140	92	0.80	40/65	B1	4.5	120	
				LN 18.131*	530941	230, 50	150	140	60	0.55	55/95	B2	4.5	120	
				L 18.934*	534621	230, 50	150	140	45	0.43	70/150	—	4.5	120	
2x18/20	T8 (T26)/T12 (T38)	G13	400	INN 2x18.043	564189	230, 50	150	135	60	0.55	40/160	A2	4.0	210	
				LN 2x18.135*	532155	230, 50	150	140	45	0.43	65	B1	4.0	210	
25	T12 (T38)	G13	290	L 25.346*	164013	230, 50	150	140	60	0.55	45/80	B1	3.5	130	
30	T8 (T26)	G13	365	INN 30.045	564191	230, 50	232.5	220	160	1.35	25/40	A2	4.5	180	
				LN 30.801*	169645	230, 50	150	140	60	0.55	55/110	B2	4.5	180	
36-1	T8 (T26)	G13	556	L 36.342*	538072	230, 50	195	180	110	0.87	50/120	B2	6.5	250	
36/40	T8 (T26)/T12 (T38)	G13	430	LN 36.570*	169779	230, 50	155	140	92	0.80	35/90	B1	4.5	210	
				LN 36.511*	164590	230, 50	155	140	92	0.80	35/95	B1	4.5	210	
				LN 36.130*	527191	230, 50	150	140	60	0.55	50/140	B2	4.5	210	
				LN 36.149*	529029	230, 50	150	140	60	0.55	55/150	B2	4.5	210	
38	T8 (T26)	G13	430	L 36.132*	535977	230, 50	150	140	45	0.43	65	—	4.5	210	
				LN 36.570*	169779	230, 50	155	140	92	0.80	35/90	B1	4.5	210	
				LN 36.511*	164590	230, 50	155	140	92	0.80	35/95	B1	4.5	210	
				LN 36.149*	529029	230, 50	150	140	60	0.55	55/150	B2	4.5	210	
58/65	T8 (T26)/T12 (T38)	G13	670	L 36.132*	535977	230, 50	150	140	45	0.43	65	—	4.5	210	
				LN 58.568*	169389	230, 50	233	220	160	1.31	35/95	B1	7.0	320	
				LN 58.990*	509349	230, 50	190	180	110	0.95	50/130	B2	7.0	320	
				LN 58.116*	508186	230, 50	190	180	92	0.80	55/160	B2	7.0	320	
				L 58.718*	169658	230, 50	190	180	92	0.80	60/170	—	7.0	320	

* Ballasts without CE marking for replacements or markets outside of the EU

Standard Ballasts 15-75 W, 240/220 V

For fluorescent lamps
Shape: 28x41 mm

Lamp				Ballast										Capacitor	
Output	Type	Base	Current	Type	Ref. No.	Voltage	a	b	c	Weight	Δt/Δtan.	Energy efficiency	C _p	Current	
W			mA			V, Hz	mm	mm	mm	kg	K		μF	mA	
240 V, 50 Hz															
2x15	T8 (T26)	G13	340	LN 30.806	533067	240, 50	150	140	60	0.55	55/130	B2	4.0	185	
16	T8 (T26)	G13	200	LN 16.417	164358	240, 50	85	75	34	0.32	60/130	B1	2.0	90	
18/20	T8 (T26)/T12 (T38)	G13	370	LN 18.507	164566	240, 50	155	140	92	0.80	35/60	B1	4.5	120	
				LN 18.162	533043	240, 50	150	140	60	0.55	60/110	B2	4.5	120	
				L 18.936*	534627	240, 50	150	140	45	0.43	70/140	—	4.5	120	
2x18/20	T8 (T26)/T12 (T38)	G13	400	LN 2x18.135	535778	240, 50	150	140	45	0.43	65	B1	4.0	210	
				LN 36.201	527196	240, 50	150	140	60	0.55	55/140	B1	4.0	210	
				LN 36.505	164555	240, 50	155	140	92	0.80	40/95	B1	4.0	210	
30	T8 (T26)	G13	365	LN 30.806	533067	240, 50	150	140	60	0.55	55/130	B2	4.5	180	
36/40	T8 (T26)/T12 (T38)	G13	430	LN 36.505	164555	240, 50	155	140	92	0.80	40/95	B1	4.5	210	
				LN 36.201	527196	240, 50	150	140	60	0.55	55/140	B2	4.5	210	
				L 36/40.443*	164438	240, 50	150	140	60	0.55	65/155	—	4.5	210	
38	T8 (T26)	G13	430	LN 36.505	164555	240, 50	155	140	92	0.80	40/95	B1	4.5	210	
				LN 36.201	527196	240, 50	150	140	60	0.55	55/140	B2	4.5	210	
				L 36/40.443*	164438	240, 50	150	140	60	0.55	65/155	—	4.5	210	
58/65	T8 (T26)/T12 (T38)	G13	670	LN 58.506	164560	240, 50	233	220	160	1.31	35/85	B1	7.0	320	
				LN 58.192	507936	240, 50	190	180	110	0.95	50/150	B2	7.0	320	
				LN 58.722	534252	240, 50	190	180	92	0.80	60/180	B2	7.0	320	
70/75	T8 (T26)/T12 (T38)	G13	670	LN 75.170	533650	240, 50	190	180	110	0.95	50/150	B2	6.0	320	
220 V, 50 Hz															
18/20	T8 (T26)/T12 (T38)	G13	370	L 18.933	534624	220, 50	150	140	45	0.43	70/160	—	4.5	120	
2x18/20	T8 (T26)/T12 (T38)	G13	430	L 36.158	530252	220, 50	150	140	45	0.43	65	—	4.0	210	
36/40	T8 (T26)/T12 (T38)	G13	430	L 36.158	530252	220, 50	150	140	45	0.43	65	—	4.5	210	
38	T8 (T26)	G13	430	L 36.158	530252	220, 50	150	140	45	0.43	65	—	4.5	210	
58/65	T8 (T26)/T12 (T38)	G13	670	L 58.625	164828	220, 50	190	180	92	0.80	55/155	—	7.0	320	
220 V, 60 Hz															
15	T8 (T26)	G13	310	L 15.007	537744	220, 60	150	140	45	0.43	55/80	—	3.0	120	
2x15	T8 (T26)	G13	350	L 30.006	537750	220, 60	150	140	45	0.43	60/120	—	4.0	185	
18/20	T8 (T26)/T12 (T38)	G13	370	L 18.121	532149	220, 60	110	100	45	0.42	65/145	—	4.0	190	
				L 18.121	528582	220, 60	150	140	45	0.43	65/145	—	4.0	190	
				L 18.149	538801	220, 60	150	140	34	0.32	75/140	—	4.0	190	
2x18/20	T8 (T26)/T12 (T38)	G13	430	L 36.120	509373	220, 60	150	140	45	0.43	60/170	—	4.0	220	
30	T8 (T26)	G13	365	L 30.006	537750	220, 60	150	140	45	0.43	60/120	—	4.0	180	
36/40	T8 (T26)/T12 (T38)	G13	430	L 36.120	509373	220, 60	150	140	45	0.43	60/170	—	4.0	220	
38	T8 (T26)	G13	430	L 36.120	509373	220, 60	150	140	45	0.43	60/170	—	4.0	230	
58/65	T8 (T26)/T12 (T38)	G13	670	L 58.657	164870	220, 60	195	180	92	0.80	55/140	—	6.0	320	

* Ballasts without CE marking for replacements or markets outside of the EU

COMPACT AND VERSATILE



VS LAMPHOLDERS FOR COMPACT FLUORESCENT LAMPS

Vossloh-Schwabe provides a broad range of lampholders for single-ended compact fluorescent lamps, with regard to which the numerous fixing methods make just about any luminaire design possible.

As compact fluorescent lamps generate considerably less heat in comparison to incandescent lamps, the advantages provided by thermoplastics can be fully utilized for lampholder design.

Almost all VS lampholders for compact fluorescent lamps are made of thermoplastic PBT and therefore bear the T marking T140, which refers to the maximum base temperature in accordance with EN 61199 (VDE 0715 T9). The use of this highly heat-resistant material was born of close cooperation between Vossloh-Schwabe and the world's leading lamp manufacturers that also use PBT for producing lamp bases. In connection with fatigue-resistant, stainless steel lamp mounting springs, harmonizing the casing material ensures a permanent and secure lamp fit.

3

Lampholders and Accessories for TC Lamps

G24, GX24 lampholders	158-162
2G7 lampholders	163
G23 lampholders	164-166
GR10q lampholders	166-167
2G10 lampholders	167
2G11 lampholders	168
Accessories	169-171
GX53-1 lampholders, accessories	171
Technical details for fluorescent lamps	208-235
General technical details	348-348
Glossary	357-359

1

2

3

4

5

6

7

8

9

10

G24, GX24 Lampholders

For single-ended compact fluorescent lamps TC-D, TC-T, TC-DEL, TC-TEL

The drawings and photos contained in this chapter only show lampholders for lamps with base G24q-1. Further drawings of lamp bases can be found on page 230.

When mounting the lampholder it has to be considered that the TC-T and TC-TEL lamp is wider than the lampholder. When using the central hole for mounting additional depressions for anti-rotation pips have to be provided.

G24, GX24 lampholders

Plain casing

Casing: PBT GF, white, T140

Nominal rating: 2/500

Push-in twin terminals: 0.5–1 mm² (lamp circuit)

In addition for G24q, GX24q lampholders:

push-in terminals: 0.5–1 mm² (starter circuit)

Rear fixing holes for self-tapping screws

acc. to ISO 1481/7049-ST4.2-C/F

Front fixing holes for screws M3

Central fixing hole for screw M3

Rotation stop

For cover caps (see p. 291–293)

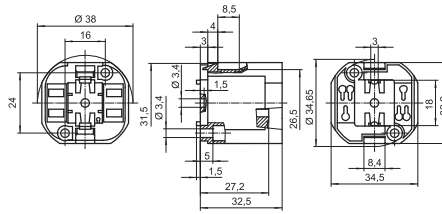

Type	Ref. No.	Base	Lamp	Output (W)	Weight (g)	Unit (pcs.)
71501	527735	G24d-1/GX24d-1	TC-D/TC-T	10, 13 / 13	13	500
71502	527736	G24d-2/GX24d-2	TC-D/TC-T	18 / 18	13	500
71503	527737	G24d-3/GX24d-3	TC-D/TC-T	26 / 26	13	500
71511	527739	G24q-1/GX24q-1	TC-DEL/TC-TEL	10, 13 / 13	14.5	500
71512	527740	G24q-2/GX24q-2	TC-DEL/TC-TEL	18 / 18	14.5	500
71513	527741	G24q-3/GX24q-3	TC-DEL/TC-TEL	26 / 26, 32	14.5	500
71519	527745	GX24q-3/-4*	TC-TEL	26, 32 / 42	14.5	500
71514	527742	GX24q-4	TC-TEL	42	14.5	500
71515	527743	GX24q-5	TC-TEL	57	15.1	500
71516	527744	GX24q-6	TC-TEL	70	15.1	500

* Lampholder 527745 may only be used in luminaires that are operated with electronic ballasts that have been certified according to the applicable standards and that cover the luminaire performance range of 26, 32 and 42 W.

Lampholders and Accessories for TC Lamps

G24, GX24 lampholders

External thread 40x2.5 IEC 60399

Casing: PBT GF, white, T140

Nominal rating: 2/500

Push-in twin terminals: 0.5–1 mm² (lamp circuit)

In addition for G24q, GX24q lampholders:

push-in terminals: 0.5–1 mm² (starter circuit)

Rear fixing holes for self-tapping screws

acc. to ISO 1481/7049-ST4.2-C/F

Front fixing holes for screws M3

Central fixing hole for screw M3

Rotation stop

For cover caps (see p. 291–293)

For screw rings (see p. 307)

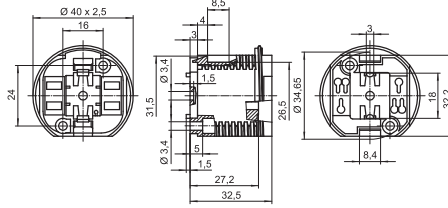

1

2

3

Type	Ref. No.	Base	Lamp	Output (W)	Weight (g)	Unit (pcs.)
71001	527502	G24d-1/GX24d-1	TC-D/TC-T	10, 13 / 13	12.7	500
71002	527503	G24d-2/GX24d-2	TC-D/TC-T	18 / 18	12.7	500
71003	527504	G24d-3/GX24d-3	TC-D/TC-T	26 / 26	12.7	500
71011	527506	G24q-1/GX24q-1	TC-DEL/TC-TEL	10, 13 / 13	15.2	500
71012	527507	G24q-2/GX24q-2	TC-DEL/TC-TEL	18 / 18	15.2	500
71013	527508	G24q-3/GX24q-3	TC-DEL/TC-TEL	26 / 26, 32	15.2	500
71019	527512	GX24q-3/-4*	TC-TEL	26, 32 / 42	15.2	500
71014	527509	GX24q-4	TC-TEL	42	15.2	500
71015	527510	GX24q-5	TC-TEL	57	15.8	500
71016	527511	GX24q-6	TC-TEL	70	15.8	500

* Lampholder 527512 may only be used in luminaires that are operated with electronic ballasts that have been certified according to the applicable standards and that cover the luminaire performance range of 26, 32 and 42 W.

4

5

G24, GX24 lampholders

Profiled shape

Casing: PBT GF, white, T140

Nominal rating: 2/500

Push-in twin terminals: 0.5–1 mm² (lamp circuit)

In addition for G24q, GX24q lampholders:

push-in terminals: 0.5–1 mm² (starter circuit)

Central fixing hole for screw M3

Rotation stop

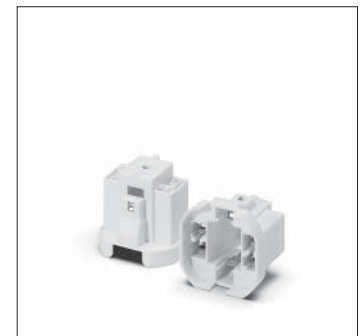
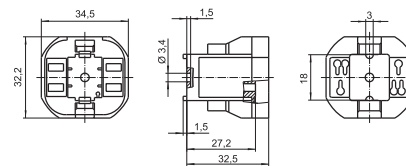

6

7

8

Type	Ref. No.	Base	Lamp	Output (W)	Weight (g)	Unit (pcs.)
71101	527529	G24d-1/GX24d-1	TC-D/TC-T	10, 13 / 13	8.5	500
71102	527530	G24d-2/GX24d-2	TC-D/TC-T	18 / 18	8.5	500
71103	527531	G24d-3/GX24d-3	TC-D/TC-T	26 / 26	8.5	500
71111	527533	G24q-1/GX24q-1	TC-DEL/TC-TEL	10, 13 / 13	10.9	500
71112	527534	G24q-2/GX24q-2	TC-DEL/TC-TEL	18 / 18	10.9	500
71113	527535	G24q-3/GX24q-3	TC-DEL/TC-TEL	26 / 26, 32	10.9	500
71119	527539	GX24q-3/-4*	TC-TEL	26, 32 / 42	10.9	500
71114	527536	GX24q-4	TC-TEL	42	10.9	500
71115	527537	GX24q-5	TC-TEL	57	11.1	500
71116	527538	GX24q-6	TC-TEL	70	11.1	500

* Lampholder 527539 may only be used in luminaires that are operated with electronic ballasts that have been certified according to the applicable standards and that cover the luminaire performance range of 26, 32 and 42 W.

9

10

Lampholders and Accessories for TC Lamps

G24, GX24 push-fit lampholders

Lamp position: 45°

Casing: PBT GF, white, T140

Nominal rating: 2/500

Push-in twin terminals: 0.5–1 mm² (lamp circuit)

In addition for G24q, GX24q lampholders:

push-in terminals: 0.5–1 mm² (starter circuit)

Push-fit foot for cut-out 10x20 mm

for wall thickness 0.6–1 mm

Foot with facility for cable routing

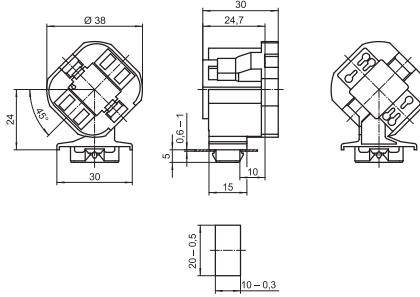

Type	Ref. No.	Base	Lamp	Output (W)	Weight (g)	Unit (pcs.)
71301	527585	G24d-1/GX24d-1	TC-D/TC-T	10, 13 / 13	10.2	500
71302	527586	G24d-2/GX24d-2	TC-D/TC-T	18 / 18	10.2	500
71303	527587	G24d-3/GX24d-3	TC-D/TC-T	26 / 26	10.2	500
71311	527589	G24q-1/GX24q-1	TC-DEL/TC-TEL	10, 13 / 13	12.1	500
71312	527590	G24q-2/GX24q-2	TC-DEL/TC-TEL	18 / 18	12.1	500
71313	527591	G24q-3/GX24q-3	TC-DEL/TC-TEL	26 / 26, 32	12.1	500
71319	527596	GX24q-3/-4*	TC-TEL	26, 32 / 42	12.1	500
71314	527592	GX24q-4	TC-TEL	42	12.1	500
71315	527594	GX24q-5	TC-TEL	57	12.6	500
71316	527595	GX24q-6	TC-TEL	70	12.6	500

* Lampholder 527596 may only be used in luminaires that are operated with electronic ballasts that have been certified according to the applicable standards and that cover the luminaire performance range of 26, 32 and 42 W.

G24, GX24 push-fit lampholders

Casing: PBT GF, white, T140

Nominal rating: 2/500

Push-in twin terminals: 0.5–1 mm² (lamp circuit)

In addition for G24q, GX24q lampholders:

push-in terminals: 0.5–1 mm² (starter circuit)

Push-fit foot for cut-out 10x20 mm

for wall thickness 0.6–1 mm

Foot with facility for cable routing

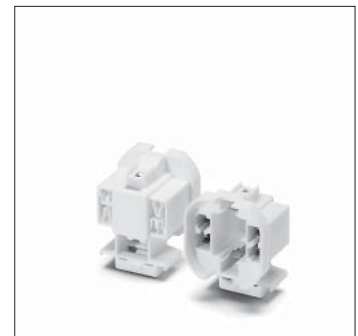
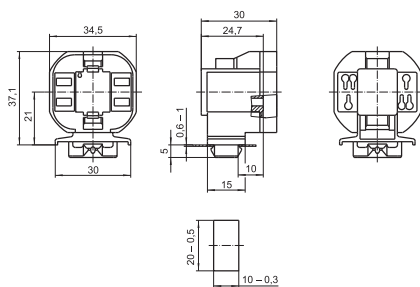

Type	Ref. No.	Base	Lamp	Output (W)	Weight (g)	Unit (pcs.)
71801	528029	G24d-1/GX24d-1	TC-D/TC-T	10, 13 / 13	10.2	500
71802	528030	G24d-2/GX24d-2	TC-D/TC-T	18 / 18	10.2	500
71803	528031	G24d-3/GX24d-3	TC-D/TC-T	26 / 26	10.2	500
71811	528033	G24q-1/GX24q-1	TC-DEL/TC-TEL	10, 13 / 13	12.1	500
71812	528034	G24q-2/GX24q-2	TC-DEL/TC-TEL	18 / 18	12.1	500
71813	528035	G24q-3/GX24q-3	TC-DEL/TC-TEL	26 / 26, 32	12.1	500
71819	528039	GX24q-3/-4*	TC-TEL	26, 32 / 42	12.1	500
71814	528036	GX24q-4	TC-TEL	42	12.1	500
71815	528037	GX24q-5	TC-TEL	57	12.7	500
71816	528038	GX24q-6	TC-TEL	70	12.7	500

* Lampholder 528039 may only be used in luminaires that are operated with electronic ballasts that have been certified according to the applicable standards and that cover the luminaire performance range of 26, 32 and 42 W.

Lampholders and Accessories for TC Lamps

G24, GX24 surface-mounted lampholders
 Casing: PBT GF, white, T140, Nominal rating: 2/500
 Push-in twin terminals: 0.5–1 mm² (lamp circuit)
 In addition for G24q, GX24q lampholders:
 push-in terminals: 0.5–1 mm² (starter circuit)
 Base fixing holes for self-tapping screws
 acc. to ISO 1481/7049-ST4.2-C/F
 Base oblong holes for screws M4
 Rear fixing holes for self-tapping screws
 acc. to ISO 1481/7049-ST2.9-C/F
 and ST4.2-C/F
 Front fixing holes for screws M3

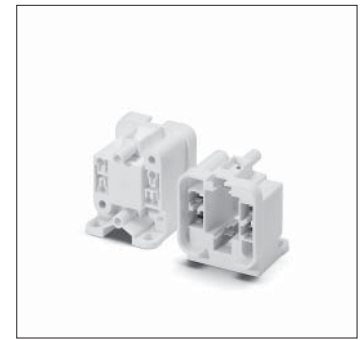
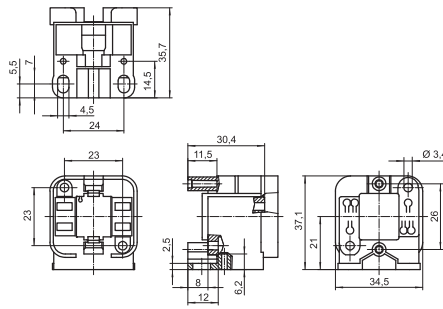

Type	Ref. No.	Base	Lamp	Output (W)	Weight (g)	Unit (pcs.)
71701	527790	G24d-1/GX24d-1	TC-D/TC-T	10, 13 / 13	13.2	500
71702	527791	G24d-2/GX24d-2	TC-D/TC-T	18 / 18	13.2	500
71703	527792	G24d-3/GX24d-3	TC-D/TC-T	26 / 26	13.2	500
71711	527794	G24q-1/GX24q-1	TC-DEL/TC-TEL	10, 13 / 13	15.2	500
71712	527795	G24q-2/GX24q-2	TC-DEL/TC-TEL	18 / 18	15.2	500
71713	527796	G24q-3/GX24q-3	TC-DEL/TC-TEL	26 / 26, 32	15.2	500
71719	527800	GX24q-3/-4*	TC-TEL	26, 32 / 42	15.2	500
71714	527797	GX24q-4	TC-TEL	42	15.2	500
71715	527798	GX24q-5	TC-TEL	57	15.8	500
71716	527799	GX24q-6	TC-TEL	70	15.8	500

* Lampholder 527800 may only be used in luminaires that are operated with electronic ballasts that have been certified according to the applicable standards and that cover the luminaire performance range of 26, 32 and 42 W. G24, GX24 surface-mounted lampholders

Casing: PBT GF, white, T140
 Nominal rating: 2/500
 Push-in twin terminals: 0.5–1 mm² (lamp circuit)
 In addition for G24q, GX24q lampholders:
 push-in terminals: 0.5–1 mm² (starter circuit)
 Front fixing holes for screws M3

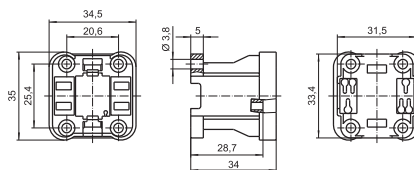

Type	Ref. No.	Base	Lamp	Output (W)	Weight (g)	Unit (pcs.)
71201	527556	G24d-1/GX24d-1	TC-D/TC-T	10, 13 / 13	12	500
71202	527557	G24d-2/GX24d-2	TC-D/TC-T	18 / 18	12	500
71203	527558	G24d-3/GX24d-3	TC-D/TC-T	26 / 26	12	500
71211	527560	G24q-1/GX24q-1	TC-DEL/TC-TEL	10, 13 / 13	12.9	500
71212	527561	G24q-2/GX24q-2	TC-DEL/TC-TEL	18 / 18	12.9	500
71213	527562	G24q-3/GX24q-3	TC-DEL/TC-TEL	26 / 26, 32	12.9	500
71219	527566	GX24q-3/-4*	TC-TEL	26, 32 / 42	12.9	500
71214	527563	GX24q-4	TC-TEL	42	12.9	500
71215	527564	GX24q-5	TC-TEL	57	13.5	500
71216	527565	GX24q-6	TC-TEL	70	13.5	500

* Lampholder 527566 may only be used in luminaires that are operated with electronic ballasts that have been certified according to the applicable standards and that cover the luminaire performance range of 26, 32 and 42 W.

Lampholders and Accessories for TC Lamps

G24, GX24 push-fit lampholders

Casing: PBT GF, white, T140

Nominal rating: 2/500

Push-in twin terminals: 0.5–1 mm² (lamp circuit)

In addition for G24q, GX24q lampholders:

push-in terminals: 0.5–1 mm² (starter circuit)

Base split pins for wall thickness 0.8–1.7 mm

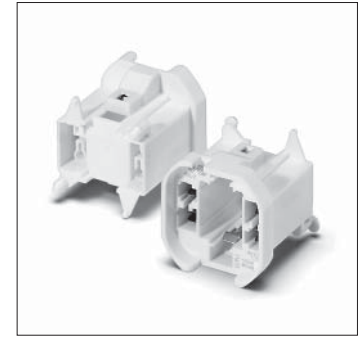
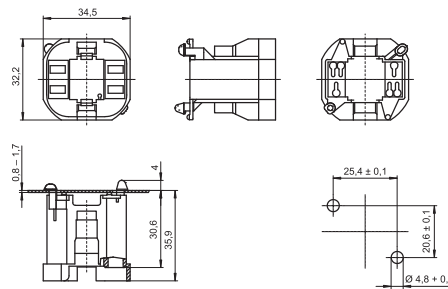

Type	Ref. No.	Base	Lamp	Output (W)	Weight (g)	Unit (pcs.)
71601	527762	G24d-1/GX24d-1	TC-D/TC-T	10, 13 / 13	10.5	500
71602	527763	G24d-2/GX24d-2	TC-D/TC-T	18 / 18	10.5	500
71603	527764	G24d-3/GX24d-3	TC-D/TC-T	26 / 26	10.5	500
71611	527766	G24q-1/GX24q-1	TC-DEL/TC-TEL	10, 13 / 13	12	500
71612	527768	G24q-2/GX24q-2	TC-DEL/TC-TEL	18 / 18	12	500
71613	527769	G24q-3/GX24q-3	TC-DEL/TC-TEL	26 / 26, 32	12	500
71619	527773	GX24q-3/-4*	TC-TEL	26, 32 / 42	12	500
71614	527770	GX24q-4	TC-TEL	42	12	500
71615	527771	GX24q-5	TC-TEL	57	12.6	500
71616	527772	GX24q-6	TC-TEL	70	12.6	500

* Lampholder 527773 may only be used in luminaires that are operated with electronic ballasts that have been certified according to the applicable standards and that cover the luminaire performance range of 26, 32 and 42 W.

G24, GX24 push-fit lampholders

Casing: PBT GF, white, T140

Nominal rating: 2/500

Push-in twin terminals: 0.5–1 mm² (lamp circuit)

In addition for G24q, GX24q lampholders:

push-in terminals: 0.5–1 mm² (starter circuit)

Rear split pins for wall thickness 0.8–1.7 mm

Width of split pin: 4.5 mm

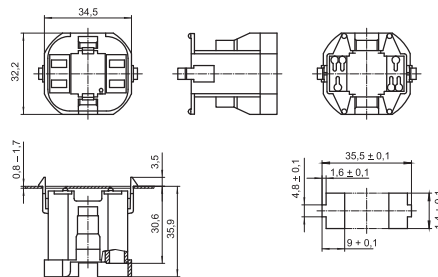

Type	Ref. No.	Base	Lamp	Output (W)	Weight (g)	Unit (pcs.)
72101	528116	G24d-1/GX24d-1	TC-D/TC-T	10, 13 / 13	10.4	500
72102	528117	G24d-2/GX24d-2	TC-D/TC-T	18 / 18	10.4	500
72103	528118	G24d-3/GX24d-3	TC-D/TC-T	26 / 26	10.4	500
72111	528120	G24q-1/GX24q-1	TC-DEL/TC-TEL	10, 13 / 13	12.3	500
72112	528121	G24q-2/GX24q-2	TC-DEL/TC-TEL	18 / 18	12.3	500
72113	528122	G24q-3/GX24q-3	TC-DEL/TC-TEL	26 / 26, 32	12.3	500
72119	528126	GX24q-3/-4*	TC-TEL	26, 32 / 42	12.3	500
72114	528123	GX24q-4	TC-TEL	42	12.3	500
72115	528124	GX24q-5	TC-TEL	57	12.9	500
72116	528125	GX24q-6	TC-TEL	70	12.9	500

* Lampholder 528126 may only be used in luminaires that are operated with electronic ballasts that have been certified according to the applicable standards and that cover the luminaire performance range of 26, 32 and 42 W.

2G7 Lampholders

For single-ended compact fluorescent lamps TC-SEL

2G7 push-fit lampholder

Casing: PBT GF, white, T140, nominal rating: 2/250

Push-in twin terminals: 0.5–1 mm² (lamp circuit)

Push-in terminals: 0.5–1 mm² (starter circuit)

Rear fixing hole for self-tapping screw
acc. to ISO 1481/7049-ST4.2-C/F

Front fixing holes for screws M3

Locking of the lampholder by a 15° turn

Weight: 13.7 g, unit: 500 pcs.

Type: 35610

Ref. No.: 109235

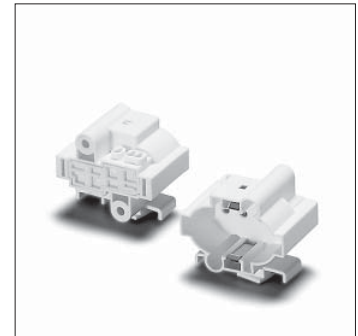
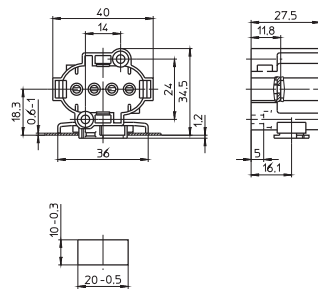

2G7 push-fit lampholder

Casing: PBT GF, white, T140

Nominal rating: 2/250

Push-in twin terminals: 0.5–1 mm² (lamp circuit)

Push-in terminals: 0.5–1 mm² (starter circuit)

Push-fit foot for cut-out 10x20 mm

for wall thickness 0.6–1 mm

Weight: 18 g, unit: 500 pcs.

Type: 35613

Ref. No.: 500574

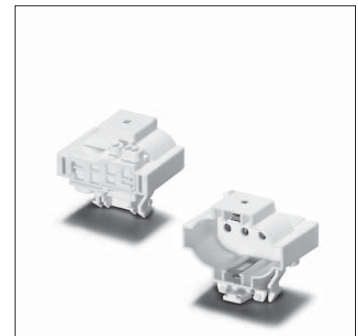
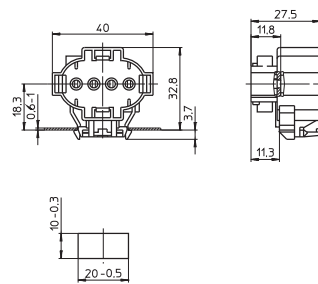

2G7 surface-mounted lampholder

Casing: PBT GF, white, T140, nominal rating: 2/250

Push-in twin terminals: 0.5–1 mm² (lamp circuit)

Push-in terminals: 0.5–1 mm² (starter circuit)

Fixing holes for screws M4

Lateral and rear fixing holes for self-tapping
screws acc. to ISO 1481/7049-ST4.2-C/F

Front fixing holes for screws M3

Weight: 18.1 g, unit: 500 pcs.

Type: 35611

Ref. No.: 109238

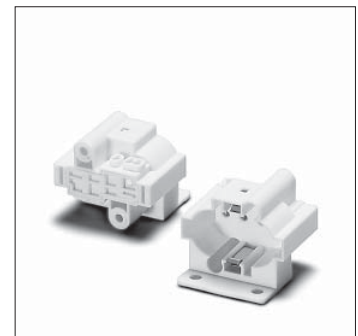
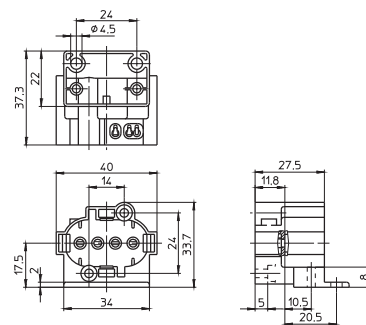

2G7 surface-mounted lampholder

Casing: PBT GF, white, T140

Nominal rating: 2/250

Push-in twin terminals: 0.5–1 mm² (lamp circuit)

Push-in terminals: 0.5–1 mm² (starter circuit)

Rear fixing holes for self-tapping screws
acc. to ISO 1481/7049-ST4.2-C/F

Front fixing holes for screws M3

Weight: 14 g, unit: 500 pcs.

Type: 35612

Ref. No.: 109240

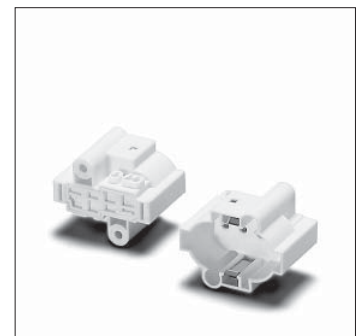
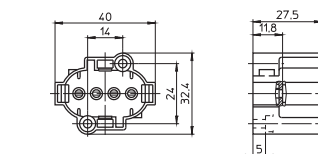

1

2

3

4

5

6

7

8

9

10

G23 Lampholders

For single-ended compact fluorescent lamps TC-S

If the central hole is used for mounting, make sure there is no risk of rotation.

G23 push-fit lampholder
 Casing: PBT GF, white, T140
 Nominal rating: 2/250
 Push-in twin terminals: 0.5–1 mm²
 Split pins for wall thickness up to 1.2 mm
 Central fixing hole for screw M3
 Weight: 12 g, unit: 500 pcs.
 Type: 35004

Ref. No.: 101298

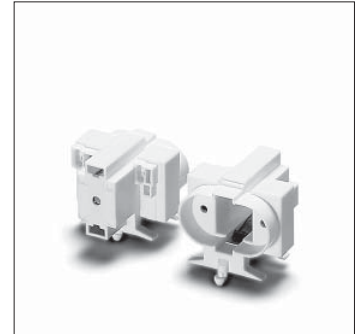
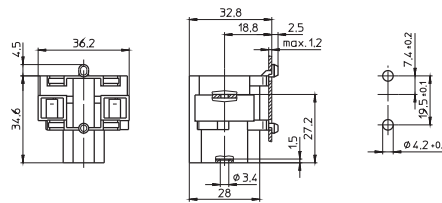

G23 surface-mounted lampholder
 Casing: PBT GF, white, T140
 Nominal rating: 2/250
 Push-in twin terminals: 0.5–1 mm²
 Fixing holes for screws M4
 Central fixing hole for screw M3
 Weight: 12.4 g, unit: 500 pcs.
 Type: 35006

Ref. No.: 101306

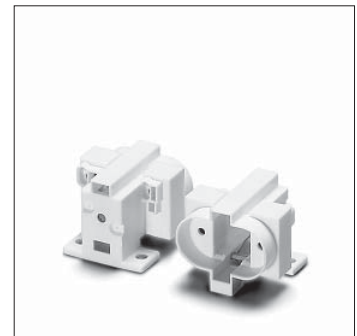
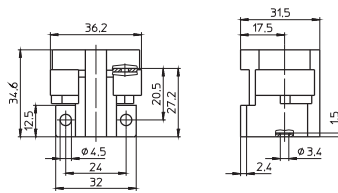

G23 lampholder
 For push-fit on track
 Casing: PBT GF, white, T140, nominal rating: 2/250
 Push-in twin terminals: 0.5–1 mm²
 Lateral fixing holes for self-tapping screws acc. to ISO 1481/7049-ST2.9-C/F
 Fixing holes for screws M4
 Central fixing hole for screw M3
 Weight: 14 g, unit: 500 pcs.
 Type: 35007

Ref. No.: 101310

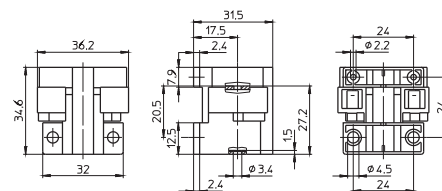

G23 surface-mounted lampholder
 Casing: PBT GF, white, T140
 Nominal rating: 2/250
 Push-in twin terminals: 0.5–1 mm²
 Fixing holes for screws M4
 Central fixing hole for screw M3
 Weight: 11.1 g, unit: 500 pcs.
 Type: 35008

Ref. No.: 101314

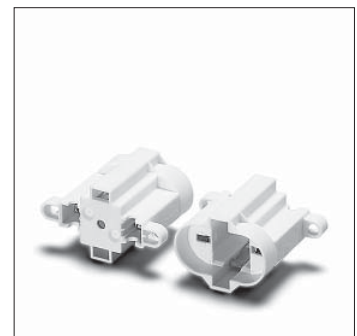
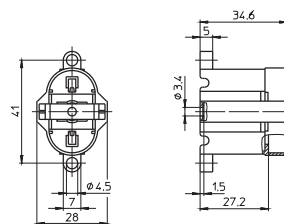

Lampholders and Accessories for TC Lamps

G23 lampholder, for cover caps (see p. 291–293)
 External thread 40x2.5 IEC 60399
 Casing: PBT GF, white, T140, nominal rating: 2/250
 Push-in twin terminals: 0.5–1 mm²
 Central fixing hole for screw M3
 When using the central hole for mounting additional depressions for anti-rotation pips have to be provided.
 For screw rings (see p. 307)
 Weight: 16.3 g, unit: 500 pcs.
 Type: 35010
Ref. No.: 101320

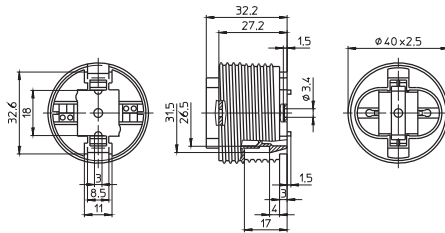

1

2

G23 lampholder
 Casing: PBT GF, white, T140
 Nominal rating: 2/250
 Push-in twin terminals: 0.5–1 mm²
 Lateral pivots for bracket 105820
 Central fixing hole for screw M3
 Weight: 11 g, unit: 500 pcs.
 Type: 35011
Ref. No.: 101324

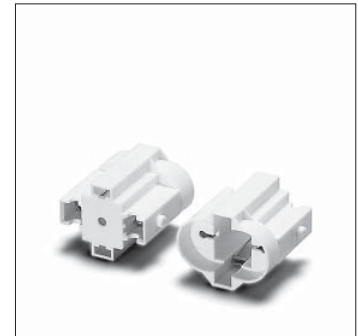
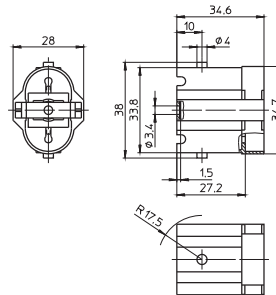

3

4

G23 surface-mounted lampholder
 Casing: PBT GF, white, T140
 Nominal rating: 2/250
 Push-in twin terminals: 0.5–1 mm²
 Front fixing holes for screws M3
 Rear fixing holes for self-tapping screws acc. to ISO 1481/7049-ST4.2-C/F
 Weight: 11.9 g, unit: 500 pcs.
 Type: 35012
Ref. No.: 108898

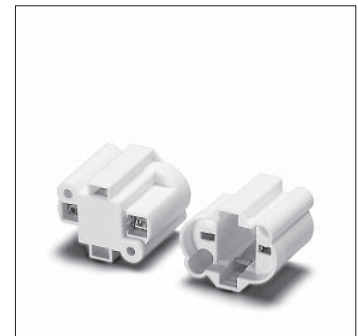
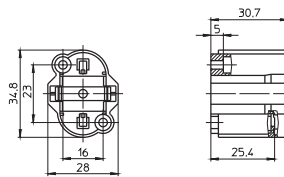

5

6

G23 push-fit lampholder
 Casing: PBT GF, white, T140
 Nominal rating: 2/250
 Push-in twin terminals: 0.5–1 mm²
 Push-fit foot for wall thickness 0.8–1.3 mm
 Central fixing hole for screw M3
 Weight: 11 g, unit: 500 pcs.
 Type: 35051
Ref. No.: 101344

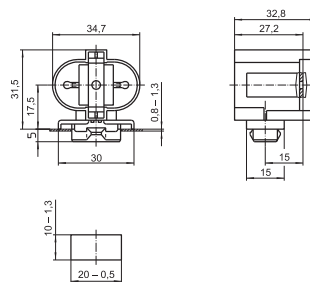

7

8

G23 push-fit lampholder
 Casing: PBT GF, white, T140
 Nominal rating: 2/250
 Push-in twin terminals: 0.5–1 mm²
 Front split pins for wall thickness 0.8–1.3 mm
 Central fixing hole for screw M3
 Weight: 12 g, unit: 500 pcs.
 Type: 35052
Ref. No.: 101346

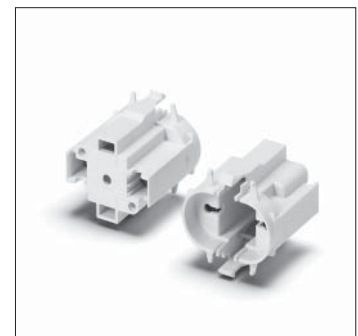
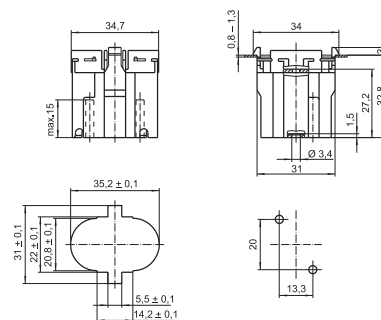

9

10

G23 lampholder

Casing: PBT GF, white, T140

Nominal rating: 2/250

Push-in terminals: 0.5–1 mm²

Central fixing hole for screw M3

Particularly suitable for narrow mounting
(e.g. for insertion into tube systems)

Weight: 8 g, unit: 500 pcs.

Type: 35201

Ref. No.: 101364

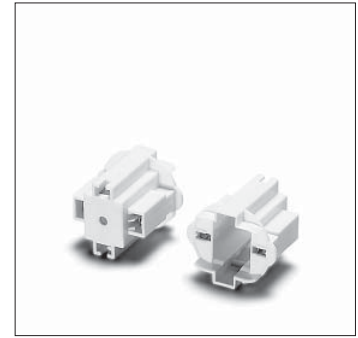
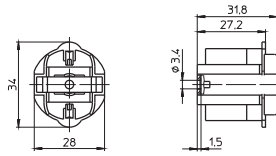

GR10q Lampholders

For single-ended compact fluorescent lamps TC-DD

GR10q push-fit lampholder

Casing: PC, white, T110

Nominal rating: 2/250

Base push-in terminals: 0.5–1 mm²

Base fixing clip for wall thickness 0.6–1 mm

Weight: 6.2 g, unit: 1000 pcs.

Type: 35500

Ref. No.: 108927

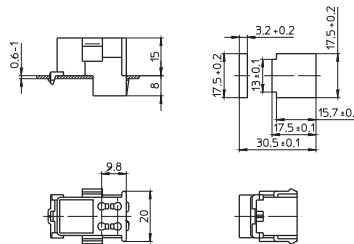

GR10q push-fit lampholder

Casing: PC, white, T110

Nominal rating: 2/250

Base push-in terminals: 0.5–1 mm²

Base split pins for wall thickness 0.6–1 mm

Weight: 6.2 g, unit: 1000 pcs.

Type: 35510

Ref. No.: 108928

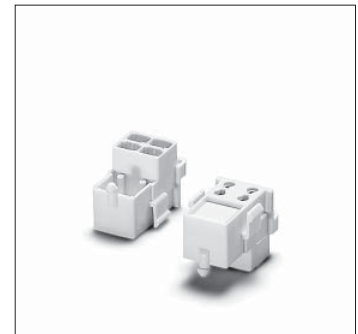
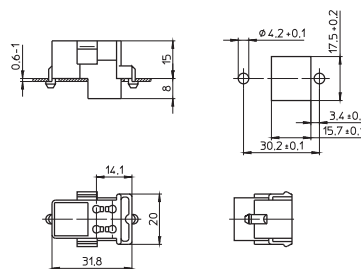

GR10q push-fit lampholder

Material: PBT, white, T110

Nominal rating: 2/250

Lateral push-in terminals: 0.5–1 mm²

Base fixing clip for wall thickness 0.6–1 mm

Weight: 7.2 g, unit: 1000 pcs.

Type: 35530

Ref. No.: 108932

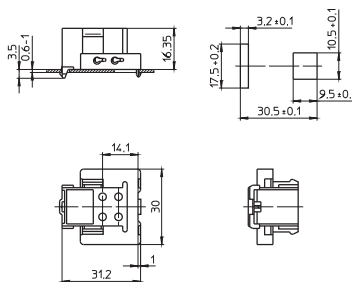

Lampholders and Accessories for TC Lamps

GR10q push-fit lampholder

Material: PBT, white, T110

Nominal rating: 2/250

Lateral push-in terminals: 0.5–1 mm²

Base split pins for wall thickness 0.6–1 mm

Weight: 7.2 g, unit: 1000 pcs.

Type: 35540

Ref. No.: 108933

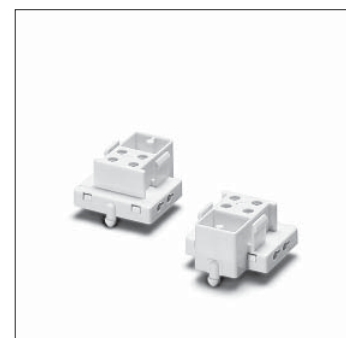
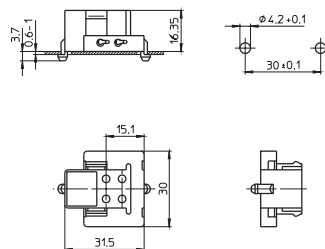

1

2

GR10q surface-mounted lampholder

Material: PBT, white, T110

Nominal rating: 2/250

Lateral push-in terminals: 0.5–1 mm²

Fastening slots for screws M3

Weight: 7.4 g, unit: 1000 pcs.

Type: 35550

Ref. No.: 108934

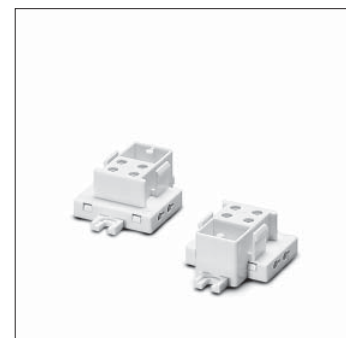
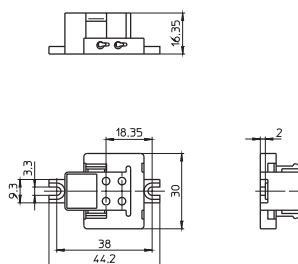

3

4

2G10 Lampholders

For single-ended compact fluorescent lamps TC-F

2G10 surface-mounted lampholder, with lamp lock

Casing: PBT GF, white, T140, nominal rating: 2/250

Push-in twin terminals: 0.5–1 mm²

Lateral lamp insertion

Front fixing holes for cheese-head screws M3

Rear fixing holes for self-tapping screws

acc. to ISO 1481/7049-ST4.2-C/F

Base fixing holes for screws M4

Weight: 25.5 g, unit: 250 pcs.

Type: 36300

Ref. No.: 101521

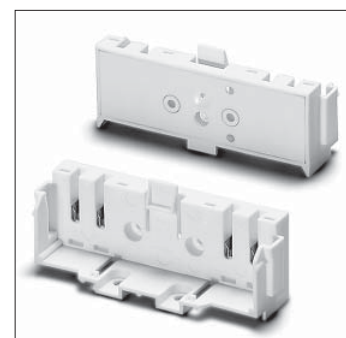
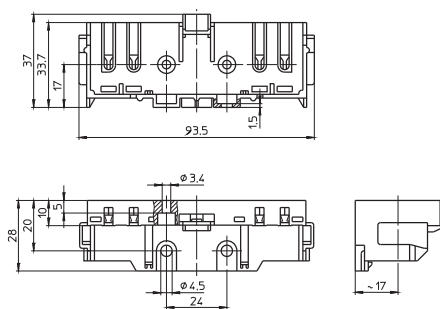

5

6

7

8

9

10

2G11 Lampholders

For single-ended compact fluorescent lamps TC-L

2G11 surface-mounted lampholder

Casing: PBT GF, white, T140, nominal rating: 2/500

Push-in twin terminals: 0.5–1 mm² (lamp circuit)

Push-in terminals: 0.5–1 mm² (starter circuit)

Base fixing holes for screws M4

Rear fixing holes for self-tapping screws

acc. to ISO 1481/7049-ST4.2-C/F

Front fixing holes for screws M3

Weight: 13.7 g, unit: 500 pcs.

Type: 36050

Ref. No.: 101485

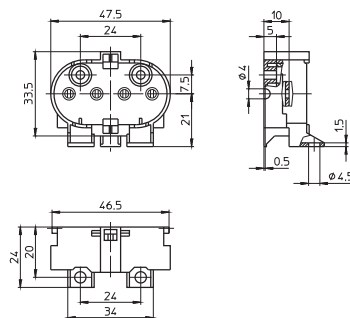

2G11 surface-mounted lampholder

Casing: PBT GF, white, T140, nominal rating: 2/500

Push-in twin terminals: 0.5–1 mm² (lamp circuit)

Push-in terminals: 0.5–1 mm² (starter circuit)

Rear fixing holes for self-tapping screws

acc. to ISO 1481/7049-ST4.2-C/F

Front fixing holes for screws M3

Weight: 12.7 g, unit: 500 pcs.

Type: 36051

Ref. No.: 101489

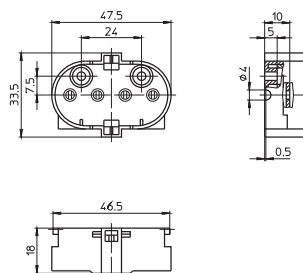

2G11 push-fit lampholder

Casing: PBT GF, white, T140, nominal rating: 2/500

Push-in twin terminals: 0.5–1 mm² (lamp circuit)

Push-in terminals: 0.5–1 mm² (starter circuit)

Lamp position: vertical

Rear fixing holes for self-tapping screws

acc. to ISO 1481/7049-ST4.2-C/F

Front fixing holes for screws M3

Weight: 14.3 g, unit: 500 pcs.

Type: 36052

Ref. No.: 101491

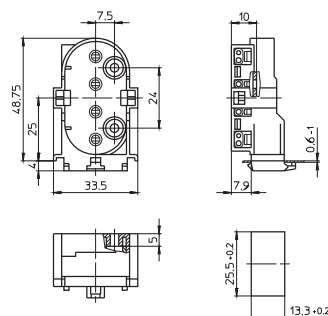

2G11 push-fit lampholder

Casing: PBT GF, white, T140, nominal rating: 2/500

Push-in twin terminals: 0.5–1 mm² (lamp circuit)

Push-in terminals: 0.5–1 mm² (starter circuit)

Rear fixing holes for self-tapping screws

acc. to ISO 1481/7049-ST4.2-C/F

Front fixing holes for screws M3

Option for base wiring

Weight: 14.1 g, unit: 500 pcs.

Type: 36053

Ref. No.: 101493

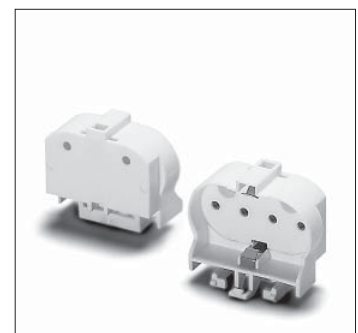
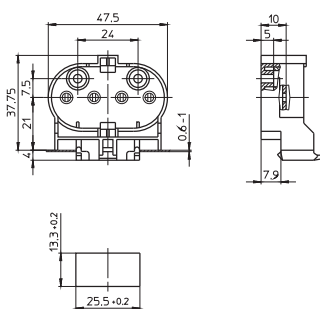

Accessories

For single-ended compact fluorescent lamps

The luminaire manufacturer is responsible for the right choice of accessories.
Cover caps for G24/GX24 lampholders
(see p. 290–293)

Lamp support for TC-D, TC-DEL lamps
Material: PC, white, UV-stabilised
Lamp position: 45°
Fixing foot with slot for screw M3.5
Weight: 1.5 g, unit: 500 pcs.
Type: 97031

Ref. No.: 105448

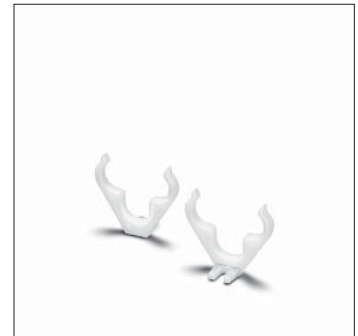
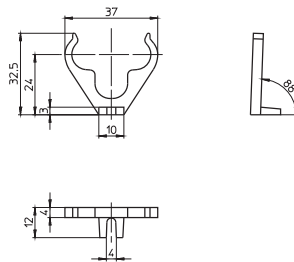

Lamp supports for TC-S, TC-SEL lamps
Height adjustable H: 17.5/20.5/23.5 mm
Push-fit foot for cut-out Ø 5.5 mm
for wall thickness up to 1 mm
Weight: 0.4/0.8/0.8 g, unit: 500 pcs.
Type: 35060

Ref. No.: 105775 foot, PC, white

Ref. No.: 105776 bracket, PC, crystal-clear, UV-stabilised

Ref. No.: 106416 bracket, PC, white, UV-stabilised

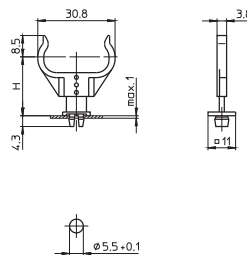

Lamp supports for TC-S, TC-SEL lamps
Height adjustable H: 27.5/30.5/33.5 mm
Push-fit foot for cut-out Ø 5.5 mm
for wall thickness up to 1 mm
Weight: 0.7/0.8/0.8 g, unit: 500 pcs.
Type: 35061

Ref. No.: 105931 foot, PC, white

Ref. No.: 105776 bracket, PC, crystal-clear, UV-stabilised

Ref. No.: 106416 bracket, PC, white, UV-stabilised

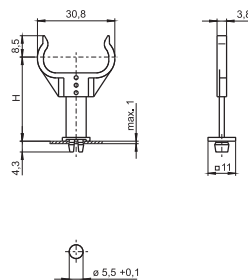

Lamp supports for TC-L lamps
Height adjustable H: 21/24/27 mm
Push-fit foot for cut-out Ø 5.5 mm
for wall thickness up to 1 mm
Weight: 0.4/1.3/1.1 g, unit: 500 pcs.
Type: 35760

Ref. No.: 105775 foot, PC, white

Ref. No.: 105777 bracket, PC, crystal-clear, UV-stabilised

Ref. No.: 106417 bracket, PC, white, UV-stabilised

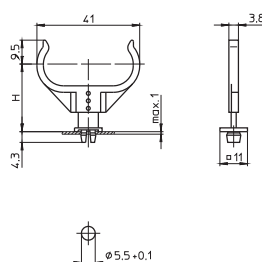

1

2

3

4

5

6

7

8

9

10

Lampholders and Accessories for TC Lamps

Lamp supports for TC-L lamps

Height adjustable H: 31/34/37 mm

Push-fit foot for cut-out \varnothing 5.5 mm

for wall thickness up to 1 mm

Weight: 0.7/1.3/1.1 g, unit: 500 pcs.

Type: 35761

Ref. No.: 105931 foot, PC, white

Ref. No.: 105777 bracket, PC, crystal-clear,
UV-stabilised

Ref. No.: 106417 bracket, PC, white,
UV-stabilised

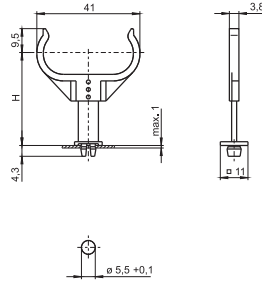

Lamp supports for TC-S, TC-SEL lamps

Material: stainless steel

Weight: 1.3 g, unit: 500 pcs.

Type: 93056 push-fit foot for \varnothing 5.5 mm

Ref. No.: 509522

Type: 93057 push-fit foot for 8.5x10.5 mm

Ref. No.: 509521

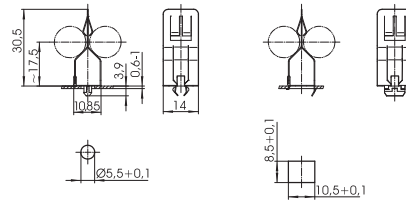

Lamp supports for TC-F, TC-L lamps

Material: stainless steel

Weight: 1.5 g, unit: 500 pcs.

Type: 93058 push-fit foot for \varnothing 5.5 mm

Ref. No.: 509520

Type: 93059 push-fit foot for 8.5x10.5 mm

Ref. No.: 509519

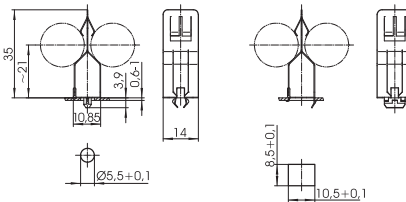

Lamp supports for TC-F, TC-L lamps

For wall thickness 0.6–1 mm

Material: PC, white, UV-stabilised

Weight: 1.3 g, unit: 500 pcs.

Type: 97638 push-fit foot for \varnothing 5.5 mm

Ref. No.: 105981

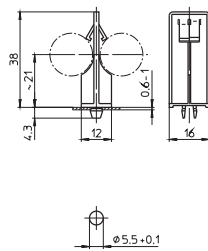

Lamp support for TC-L lamps

Material: PC, white, UV-stabilised

Push-fit foot for cut-out \varnothing 5.5 mm

for wall thickness up to 1 mm

Weight: 0.7 g, unit: 500 pcs.

Type: 36060

Ref. No.: 108878

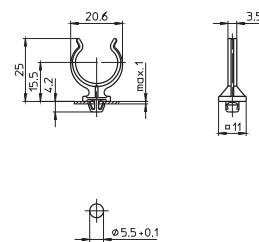

Lampholders and Accessories for TC Lamps

Lamp support for TC-L lamps
 Material: PC, crystal-clear, UV-stabilised
 Lockable
 Base split pins for wall thickness 0.6–1 mm
 Weight: 4 g, unit: 500 pcs.
 Type: 36061

Ref. No.: 101497

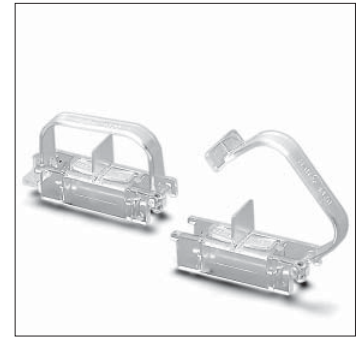
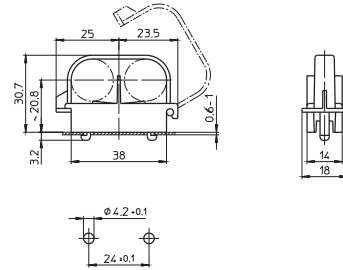

1

2

GX53-1 Lampholders, Accessories

For single-ended compact fluorescent lamps with integrated ballasts

GX53-1 lampholder
 Casing: PC, white, T100, nominal rating: 2/250
 Push-in terminals for through-wiring
 for single-core leads: 0.5–1 mm²
 for stranded leads:
 0.75 mm², tinned lead ends

Fixing holes for screws M3
 Weight: 12.8 g, unit: 200 pcs.

Type: 11000

Ref. No.: 530878

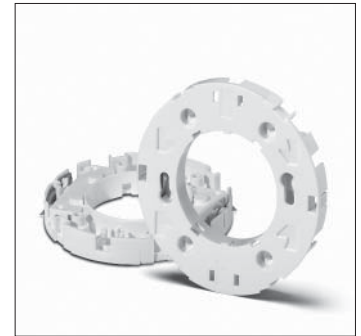
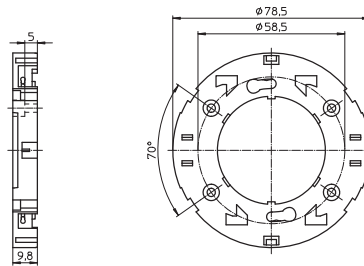

3

4

GX53-1 lampholder
 Fixing springs for installation into furniture panels
 Casing: PC, white, T100, nominal rating: 2/250
 Push-in terminals for through-wiring
 for single-core leads: 0.5–1 mm²
 for stranded leads:
 0.75 mm², tinned lead ends

Cut-out: $\varnothing 78^{+0.2}$ mm
 Weight: 13.2 g, unit: 200 pcs.

Type: 11010

Ref. No.: 530879

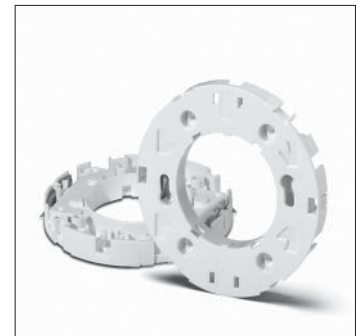
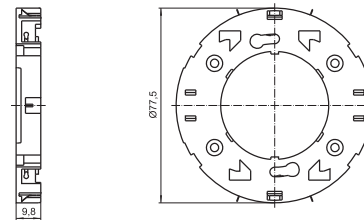

5

6

Cord grip/cover plate for GX53-1 lampholders
 For leads H03VVH2-F 2X0.75, tinned lead ends
 For luminaires of protection class II
 Material: PC, white
 Weight: 1.6 g, unit: 200 pcs.
 Type: 97278

Ref. No.: 504939

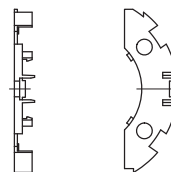

7

8

Surface-mounted installation ring
 For wood or furniture panels
 Material: PC, white
 Weight: 10.4 g, unit: 100 pcs.
 Type: 97277

Ref. No.: 504938



9

10

LAMPHOLDERS FOR T5, T8, T12 AND T2 LAMPS



VS LAMPHOLDERS FOR DOUBLE- ENDED FLUORESCENT LAMPS

Vossloh-Schwabe's comprehensive range of lampholders for double-ended fluorescent lamps covers all major fixing methods. Push-through, push-fit and built-in lampholders with split pins or catches are available just as models with screw and push fittings.

High-grade materials for the contacts and thermoplastics for the casings guarantee reliable contacts and a long service life of the components.

Special G13 lampholders for the USA and Canada can be found under www.unvlt.com.



G5 lampholders

G5 lampholders, accessories
 G5 twin lampholder
 G5 lampholders, degree of protection IP54/IP65/IP67
 Lamp supports for lamps T-R5

174–180

174–178
 178
 179–180
 180

G13 lampholders

G13 push-through lampholders
 G13 push-fit lampholders
 G13 push-fit twin lampholders, accessories
 G13 built-in lampholders
 G13 surface-mounted lampholders
 Accessories for T8 and T12 lamps
 G13 lampholders, degree of protection IP54/IP65/IP67, accessories

181–197

181–183
 183–185
 186–187
 187–190
 191
 192–193
 194–197

Technical details for fluorescent lamps

General technical details
 Glossary

208–235

348–356
 357–359

1

2

3

4

5

6

7

8

9

10

G5 Lampholders, Accessories

For fluorescent lamps T5 (T16)

Max. permitted temperature T_m
on the rear side of the lampholder: 110 °C

G5 push-through/surface-mounted lampholder
Lamp axis push-through lampholder: 13.2 mm
Lamp axis surface-mounted lampholder: 15.2 mm
Casing: PC, white, T110
Nominal rating: 2/500
Push-in terminals: 0.5–1 mm²
Lateral fixing clips for wall thickness 0.5–1.5 mm
Fixing slot for screw M3
Weight: 3.2 g, unit: 1000 pcs.
Type: 09105

Ref. No.: 100305

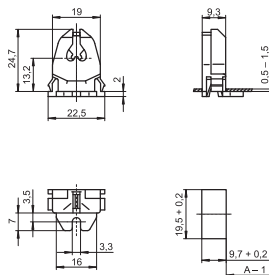

G5 built-in lampholder
Casing: PC, white, T110
Nominal rating: 2/500
Push-in terminals: 0.5–1 mm²
Rear split pins for wall thickness up to 1.2 mm
Weight: 2.6 g, unit: 1000 pcs.
Type: 09205

Ref. No.: 100310

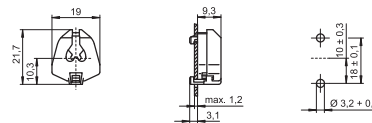

G5 built-in/push-fit lampholder
Lamp axis: 12 mm
Casing: PC, white, T110
Nominal rating: 2/500
Push-in terminals: 0.5–1 mm²
Rear split pins for wall thickness up to 1.2 mm
Base split pins for wall thickness up to 1 mm
Weight: 2.9 g, unit: 1000 pcs.
Type: 09210

Ref. No.: 106455

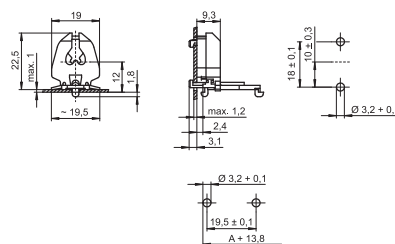

G5 push-through lampholders
For the automatic luminaire wiring
Casing: PBT GF, white, frontplate: PC, white
Rotor: PBT GF, white, T140, lamp axis: 15 mm
Nominal rating: 2/500
IDC terminals for leads H05V-U 0.5
Lateral fixing clips for wall thickness 0.5–1.5 mm
Weight: 5 g, unit: 1000 pcs.
Type: 09420/ 09421

Ref. No.: 532377 with stop

Ref. No.: 532378 without stop

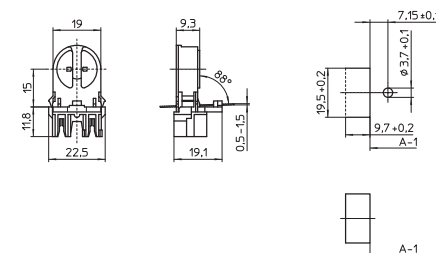

Lampholders and Accessories for T Lamps

G5 push-fit lampholder

For the automatic luminaire wiring

Lamp axis: 18 mm

Casing: PC, white, rotor: PBT GF, white, T130

Nominal rating: 2/500

IDC terminals for leads H05V-U 0.5

Lateral push-in twin terminals: 0.5–1 mm²

Weight: 5.5 g, unit: 1000 pcs.

Type: 09900

Ref. No.: 534644

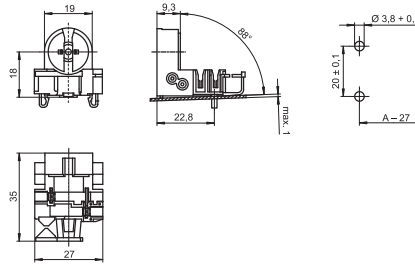

1

2

G5 built-in lampholder

Casing: PBT GF, white, rotor: PBT GF, white

T140, nominal rating: 2/500

Push-in twin terminals: 0.5–1 mm²

Lateral fixing clips

Weight: 2.8 g, unit: 1000 pcs.

Type: 09404

Ref. No.: 505732

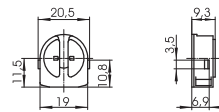

3

4

G5 built-in lampholders

Casing: PBT GF, white, rotor: PBT GF, white

T140, nominal rating: 2/500

Push-in twin terminals: 0.5–1 mm²

Rear split pins for wall thickness up to 1.2 mm

Weight: 2.9/3.3 g, unit: 1000 pcs.

Type: 09405

Ref. No.: 505733

Type: 09406 with spring adjustment

Ref. No.: 505734

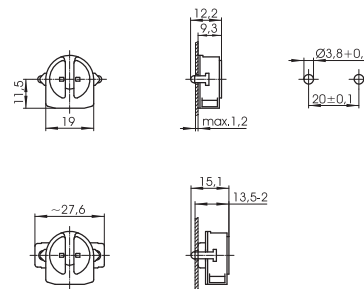

5

6

G5 built-in lampholder

Lampholder thickness: 12.5 mm

Casing: PBT GF, white, rotor: PBT GF, white

T140, nominal rating: 2/500

Push-in twin terminals: 0.5–1 mm²

Rear split pins for wall thickness up to 1 mm

Weight: 3 g, unit: 1000 pcs.

Type: 09407

Ref. No.: 508590

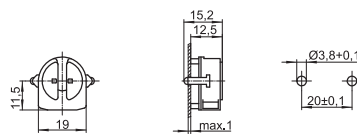

7

8

G5 built-in lampholders

Casing: PBT GF, white, rotor: PBT GF, white

T140, nominal rating: 2/500

Push-in twin terminals: 0.5–1 mm²

Rear split pins for wall thickness up to 1.2 mm

Weight: 2.9/3.2 g, unit: 1000 pcs.

Type: 09415

Ref. No.: 505735

Type: 09416 with spring adjustment

Ref. No.: 505736

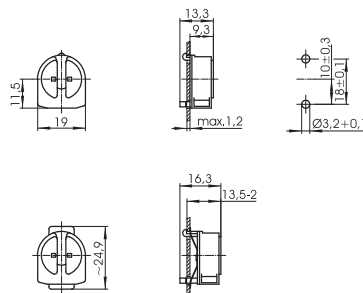

9

10

Lampholders and Accessories for T Lamps

G5 push-through lampholders

Lamp axis: 15 mm

Casing: PBT GF, white, rotor: PBT GF, white

T140, nominal rating: 2/500

Push-in twin terminals: 0.5–1 mm²

Lateral fixing clips for wall thickness 0.5–1.5 mm

Weight: 3.5/3.4 g, unit: 1000 pcs.

Type: 09420/09421

Ref. No.: 505737 with stop

Ref. No.: 505739 without stop

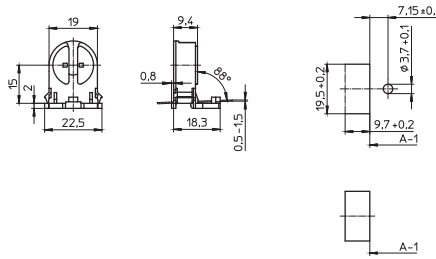

G5 push-through lampholders

Lamp axis: 20 mm

Casing: PBT GF, white, rotor: PBT GF, white

T140, nominal rating: 2/500

Push-in twin terminals: 0.5–1 mm²

Lateral fixing clips for wall thickness 0.5–1.5 mm

Weight: 4.1 g, unit: 1000 pcs.

Type: 09432/09433

Ref. No.: 545933 with stop

Ref. No.: 545935 without stop

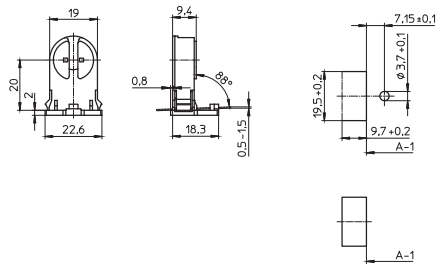

G5 push-through lampholders

Lamp axis: 25 mm

Casing: PBT GF, white, rotor: PBT GF, white

T140, nominal rating: 2/500

Push-in twin terminals: 0.5–1 mm²

Lateral fixing clips for wall thickness 0.5–1.5 mm

Weight: 4.5 g, unit: 1000 pcs.

Type: 09434/09435

Ref. No.: 545937 with stop

Ref. No.: 545939 without stop

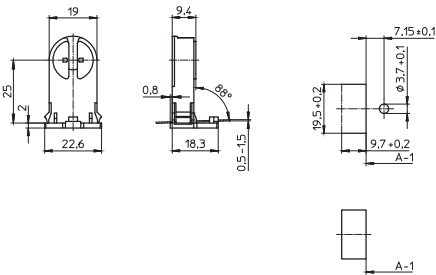

G5 push-through lampholders

Lamp axis: 35 mm

Casing: PBT GF, white, rotor: PBT GF, white

T140, nominal rating: 2/500

Push-in twin terminals: 0.5–1 mm²

Lateral fixing clips for wall thickness 0.5–1.5 mm

Weight: 4.6 g, unit: 1000 pcs.

Type: 09426/09427

Ref. No.: 505745 with stop

Ref. No.: 505746 without stop

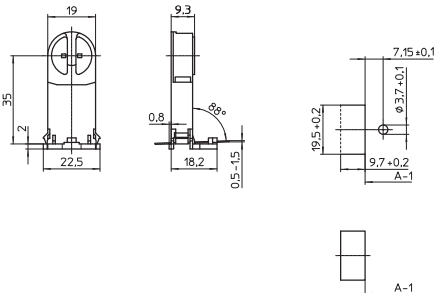

G5 push-fit lampholder

Lamp axis: 14 mm

Casing: PBT GF, white, rotor: PBT GF, white

T140, nominal rating: 2/500

Push-in twin terminals: 0.5–1 mm²

Rear fixing clips for wall thickness 0.6–1 mm

Base or lateral wiring

Weight: 3.3 g, unit: 1000 pcs.

Type: 09440

Ref. No.: 505747

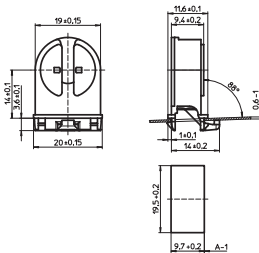

Lampholders and Accessories for T Lamps

G5 push-fit lampholder

Lamp axis: 18 mm
 Casing: PBT GF, white, rotor: PBT GF, white
 T140, nominal rating: 2/500
 Push-in twin terminals: 0.5–1 mm²
 Rear fixing clips for wall thickness 0.6–1 mm
 Base or lateral wiring
 Weight: 3.9 g, unit: 1000 pcs.
 Type: 09446

Ref. No.: 545894

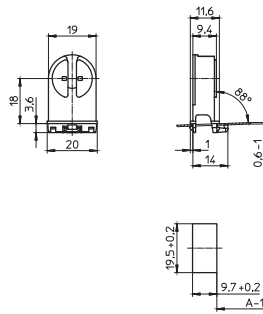

1

2

G5 push-fit lampholder

Lamp axis: 23 mm
 Casing: PBT GF, white, rotor: PBT GF, white
 T140, nominal rating: 2/500
 Push-in twin terminals: 0.5–1 mm²
 Rear fixing clips for wall thickness 0.6–1 mm
 Base or lateral wiring
 Weight: 4.2 g, unit: 1000 pcs.
 Type: 09447

Ref. No.: 545896

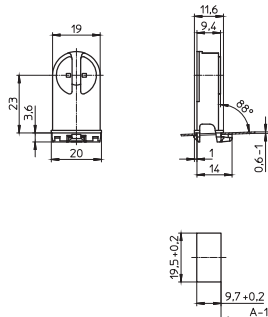

3

4

G5 push-fit lampholder

Lamp axis: 15 mm
 Casing: PBT GF, white, rotor: PBT GF, white
 T140, nominal rating: 2/500
 Push-in twin terminals: 0.5–1 mm²
 Base split pins for wall thickness 0.6–1 mm
 Weight: 3.4 g, unit: 1000 pcs.
 Type: 09450

Ref. No.: 505750

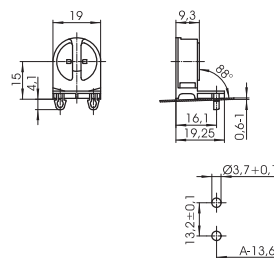

5

6

G5 push-fit lampholder

Lamp axis: 11.8 mm
 Casing: PBT GF, white, rotor: PBT GF, white
 T140, nominal rating: 2/500
 Push-in twin terminals: 0.5–1 mm²
 Base split pins for wall thickness up to 1 mm
 Lateral wiring
 Weight: 3.1 g, unit: 1000 pcs.
 Type: 09460

Ref. No.: 505751

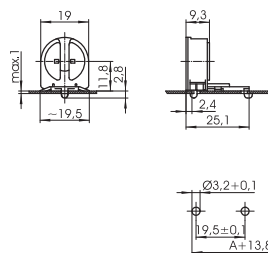

7

8

G5 lampholder

For push-fit onto the lamp
 Casing: PBT GF, white, T130
 Nominal rating: 2/500
 Push-in twin terminals: 0.5–1 mm²
 Pin support for reliable contact
 Lamp support 109685 (see page 178)
 Weight: 3.7 g, unit: 1000 pcs.
 Type: 09170

Ref. No.: 109686

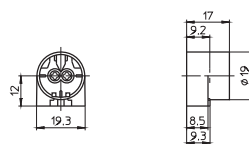

9

10

Lampholders and Accessories for T Lamps

Lamp support for lamps \varnothing 16 mm
 Material: zinc-coated polished steel
 Fixing hole for screw M3,5
 Weight: 1.3 g, unit: 1000 pcs.
 Type: 94088

Ref. No.: 109685

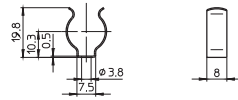

Lamp support for lamps \varnothing 16 mm
 Material: PC, white, UV-stabilised
 Push-fit foot for cut-out \varnothing 5.5 mm
 Weight: 1 g, unit: 500 pcs.
 Type: 84001

Ref. No.: 500757

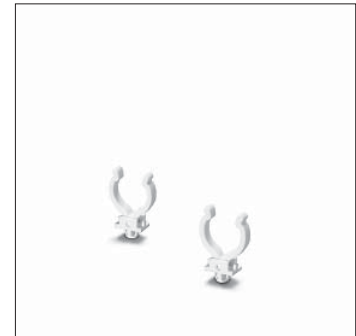
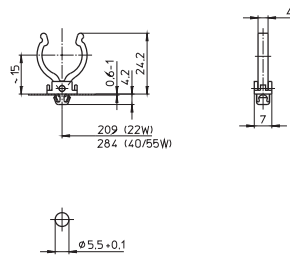

G5 Twin Lampholder

For fluorescent lamps T5 (T16)

Max. permitted temperature T_m
 on the rear side of the lampholder: 110 °C

G5 built-in lampholder
 Casing: PBT GF, white, rotor: PBT GF, white
 T140, nominal rating: 2/500
 Push-in twin terminals: 0.5–1 mm²
 Lateral fixing clips
 Weight: 2.8 g, unit: 1000 pcs.
 Type: 09404

Ref. No.: 505732

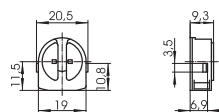

Push-fit bracket
 For two G5 built-in lampholders 505732
 Material: PC, white
 Lamp axis: 20 mm
 Distance between two lamp axes: 24 mm
 Push-fit foot for wall thickness 0.5–1 mm
 Weight: 3.5 g, unit: 1000 pcs.
 Type: 97677

Ref. No.: 507562

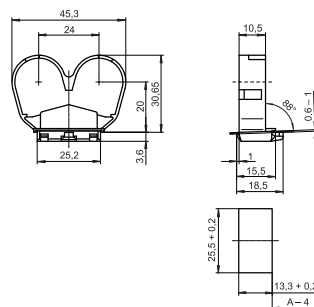

G5 Lampholders, Degree of Protection IP54/IP65/IP67

For fluorescent lamps T5 (T16)
For luminaires of protection class I and II

Lampholders protected against dust and splashing water (IP54)
 Lampholders protected against dust and jet of water (IP65)
 Dust and watertight lampholders (IP67)

Pin support for reliable contact
 With spring adjustment
 Max. permitted temperature T_m
 on the rear side of the lampholder: 110 °C

G5 push-fit lampholder for metal casing
 Casing: PC, white, interior part: PBT GF T140, nominal rating: 2/500
 Push-in twin terminals: 0.5–1 mm²
 Push-fit foot for wall thickness: 1.4–2 mm
 Weight: 11.3 g, unit: 500 pcs.

Type: 84101 system 153

Ref. No.: 529832

Foot gaskets for systems 153

Weight: 0.5/0.7/0.7 g

Unit: 1000 pcs.

Type: 98002 degree of protection IP67

Ref. No.: 108947 material: PE foam

Type: 98087 degree of protection IP67

Ref. No.: 503773 material: EPDM, black

Type: 98003 degree of protection IP54

Ref. No.: 108266 material: EPDM, black

G5 push-fit lampholder

Casing: PC, white, interior part: PBT GF T140, nominal rating: 2/500

Push-in twin terminals: 0.5–1 mm²

Push-fit foot for wall thickness: 1.4–2 mm

Weight: 12.7 g, unit: 250 pcs.

Type: 84108 system 151

Ref. No.: 534073

Foot gaskets for system 151

Weight: 1/1.1/1.1 g

Unit: 1000 pcs.

Type: 98004 degree of protection IP65

Ref. No.: 108267 material: cellular rubber, black

Type: 98011 degree of protection IP67

Ref. No.: 504078 material: silicone, transparent

Type: 98008 degree of protection IP67

Ref. No.: 546254 profiled foot gasket, material: EPDM, black

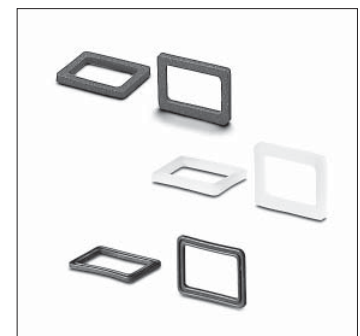
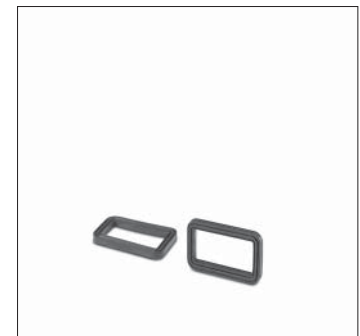
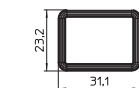
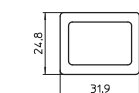
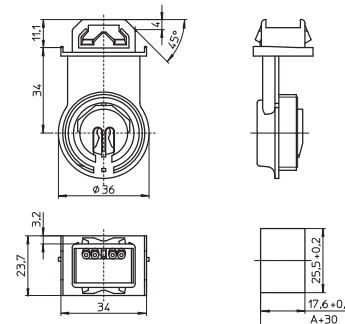
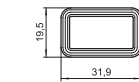
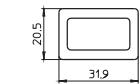
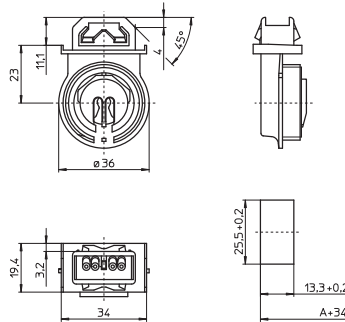

1

2

3

4

5

6

7

8

9

10

Lampholders and Accessories for T Lamps

Screw ring for systems 151 and 153

Ring: PBT GF, white, gasket: silicone

Weight: 11.8 g, unit: 250 pcs.

Type: 84103

Ref. No.: 529836

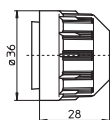

Lamp supports for lamps T-R5

For fluorescent lamps T-R5 (T-R16)

Lamp support for lamps \varnothing 16 mm

Material: PC, white, UV-stabilised

Fixing hole for screw M3

Fixing hole for self-tapping screw

acc. to ISO 1481/7049-ST4.2-C/F

Weight: 1 g, unit: 500 pcs.

Type: 84000

Ref. No.: 109532

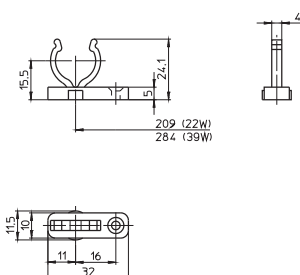

Lamp support for lamps \varnothing 16 mm

Material: PC, white, UV-stabilised

Push-fit foot for cut-out \varnothing 5.5 mm

Weight: 1 g, unit: 500 pcs.

Type: 84001

Ref. No.: 500757

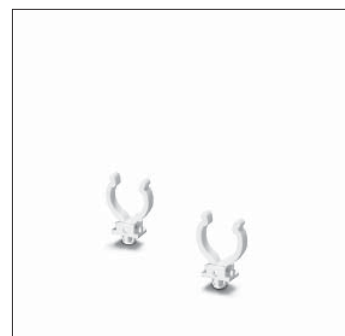
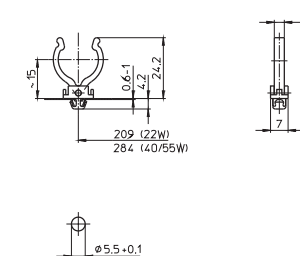

G13 Push-through Lampholders

For fluorescent lamps T8 (T26), T12 (T38)

Lampholders with integrated starter holder have push-in twin terminals for the lamp circuit and push-in terminals for the starter circuit.
Pin support for reliable contact
Max. permitted temperature T_m on the rear side of the lampholder: 110 °C

G13 push-through lampholders for lamps T8 and T12

Lamp axis: 23 mm

Casing: PC, white, frontplate: PBT GF, white

T140, nominal rating: 2/500

Push-in terminals: 0.5–1 mm²

Lateral fixing clips for wall thickness 0.4–2 mm

Weight: 6 g, unit: 1000 pcs.

Type: 27700/27701

Ref. No.: 109330 with stop

Ref. No.: 109331 without stop

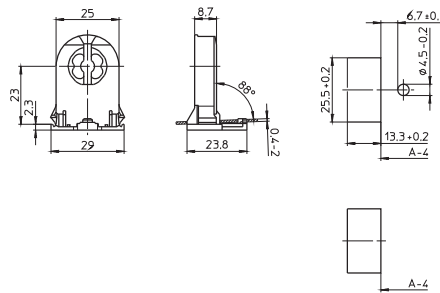

G13 Rotoclic push-through lampholders

for lamps T8 and T12

Lamp axis: 23 mm

Casing: PC, white, frontplate: PBT GF, white

T140, nominal rating: 2/500

Push-in terminals: 0.5–1 mm²

Lateral fixing clips for wall thickness 0.4–2 mm

Weight: 6.8 g, unit: 1000 pcs.

Type: 27700/27701

Ref. No.: 546641 with stop

Ref. No.: 546642 without stop

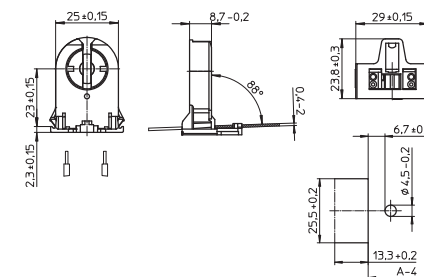

G13 push-through lampholders for lamps T8

With starter attachment

Lamp axis: 23 mm

Casing: PC, white, frontplate: PBT GF, white

T140, nominal rating: 2/500

Push-in terminals: 0.5–1 mm²

Lateral fixing clips for wall thickness 0.4–2 mm

Weight: 10.4 g, unit: 500 pcs.

Type: 27800/27801

Ref. No.: 109332 with stop

Ref. No.: 109335 without stop

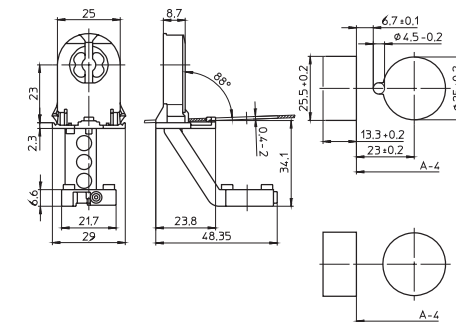

G13 Rotoclic push-through lampholders

for lamps T8, with starter attachment

Lamp axis: 23 mm

Casing: PC, white, frontplate: PBT GF, white

T140, nominal rating: 2/500

Push-in terminals: 0.5–1 mm²

Lateral fixing clips for wall thickness 0.4–2 mm

Weight: 10.4 g, unit: 500 pcs.

Type: 27800/27801

Ref. No.: 546647 with stop

Ref. No.: 546648 without stop

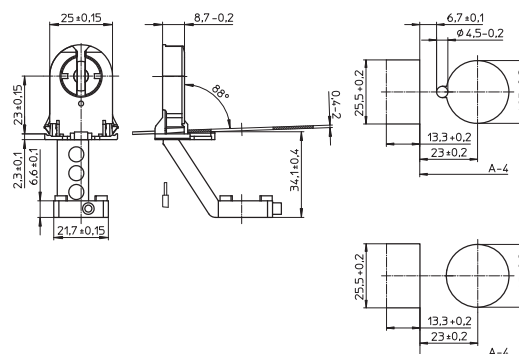

Starter Holders and Terminal Blocks, Accessories

G13 push-through lampholders for lamps T8, T12

Lamp axis: 17 mm

Casing: PC, white, frontplate: PBT GF, white

T140, nominal rating: 2/500

Push-in terminals: 0.5–1 mm²

Lateral fixing clips for wall thickness 0.4–2 mm

Weight: 5,4 g, unit: 1000 pcs.

Type: 26300/26310

Ref. No.: 551271 with stop

Ref. No.: 551272 without stop

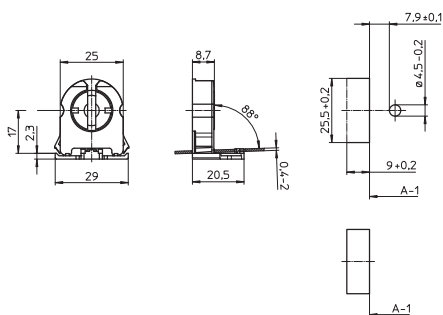

G13 push-through lampholders for lamps T8 and T12

With starter attachment

Lamp axis: 22.5 mm

Casing: PC, white, rotor: PBT, white

T130, nominal rating: 2/500

Push-in terminals: 0.5–1 mm²

Lateral fixing clips for wall thickness 0.6–2 mm

Weight: 9,5 g, unit: 500 pcs.

Type: 27820/27821

Ref. No.: 100579 with stop

Ref. No.: 100581 without stop

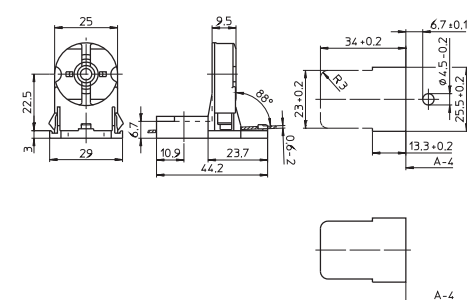

G13 push-through lampholders for lamps T8 and T12

Lamp axis: 31 mm

Casing: PC, white, frontplate: PBT GF, white

T140, nominal rating: 2/500

Push-in terminals: 0.5–1 mm²

Lateral fixing clips for wall thickness 0.4–2 mm

Weight: 7,8 g, unit: 1000 pcs.

Type: 28500/28501

Ref. No.: 109338 with stop

Ref. No.: 109339 without stop

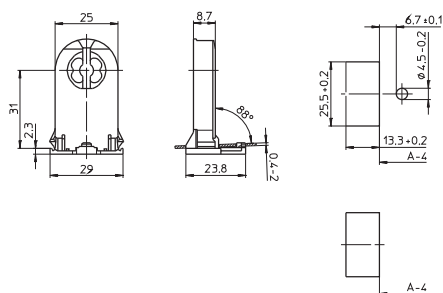

G13 push-through lampholders for lamps T8 and T12

With starter attachment

Lamp axis: 31 mm

Casing: PC, white, frontplate: PBT GF, white

T140, nominal rating: 2/500

Push-in terminals: 0.5–1 mm²

Lateral fixing clips for wall thickness 0.4–2 mm

Weight: 10.3/10.1 g, unit: 500 pcs.

Type: 28600/28601

Ref. No.: 109340 with stop

Ref. No.: 109341 without stop

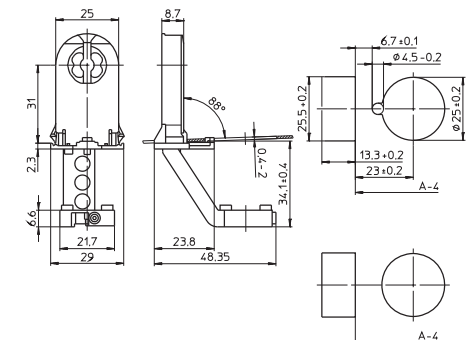

G13 push-through lampholders for lamps T8 and T12

Lamp axis: 31 mm

Casing: PC, white, rotor: PBT GF, white

T130, nominal rating: 2/500

Push-in terminals: 0.5–1 mm²

Lateral fixing clips for wall thickness 0.6–2 mm

Weight: 9,6 g, unit: 500 pcs.

Type: 28740/28741

Ref. No.: 542983 with stop

Ref. No.: 542984 without stop

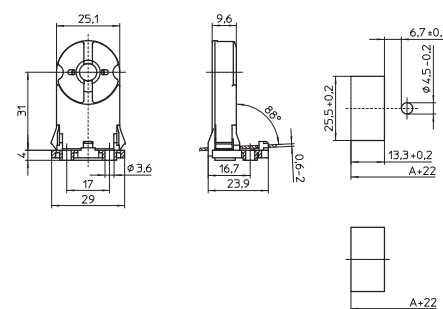

Lampholders and Accessories for T Lamps

G13 push-through lampholders for lamps T8 and T12
Lamp axis: 31 mm

Casing: PC, white, rotor: PBT, white

T130, nominal rating: 2/500

Push-in terminals: 0.5–1 mm²

Lateral fixing clips for wall thickness 0.6–2 mm

Weight: 9.9 g, unit: 1000 pcs.

Type: 28500/28501

Ref. No.: 100591 with stop

Ref. No.: 100593 without stop

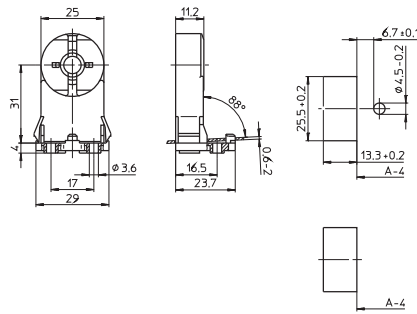

1

2

3

G13 Push-fit Lampholders

For fluorescent lamps T8 (T26), T12 (T38)

Lampholders with integrated starter holder are equipped with big rotor and have push-in twin terminals for the lamp circuit and push-in terminals for the starter circuit. Pin support for reliable contact

Casing: PC, white, frontplate/rotor: PBT GF, white
Max. permitted temperature T_m on the rear side of the lampholder: 110 °C
T-Marking acc. to IEC
IP50 version: push-fit foot with gasket

G13 Rotoclic push-fit lampholders for lamps T8 and T12
T140, nominal rating: 2/500, suitable for Top Test

Lateral push-in terminals: 0.5–1 mm²

Push-fit foot for luminaire cut-out 13.3x25.5 mm with wall thickness 0.6–1 mm

Lampholder foot/luminaire: IP40 (537135: IP50)

Weight: 5.9/5.9/6/6 g, unit: 1000 pcs.

Type: 24100/24110/24170/24150

Ref. No.: 537132 lamp axis H: 25 mm

Ref. No.: 537135 lamp axis H: 25 mm, IP50

Ref. No.: 537150 lamp axis H: 21 mm

Ref. No.: 537144 lamp axis H: 18 mm

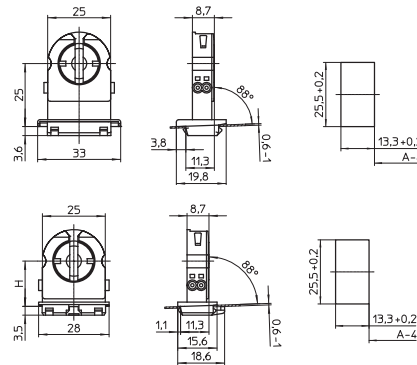

5

6

G13 Rotoclic push-fit lampholders for lamps T8 and T12
T140, nominal rating: 2/500, suitable for Top Test

Lateral push-in terminals: 0.5–1 mm²

Push-fit foot for luminaire cut-out 10x20 mm with wall thickness 0.6–1 mm

Lampholder foot/luminaire: IP40

Weight: 5.7/6 g, unit: 1000 pcs.

Type: 24120/24160

Ref. No.: 537138 lamp axis H: 25 mm

Ref. No.: 537147 lamp axis H: 21 mm

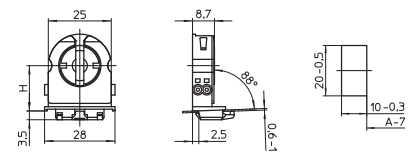

7

8

G13 Rotoclic push-fit lampholders for lamps T8
T140, nominal rating: 2/500

Base push-in terminals: 0.5–1 mm²

Base split pins for wall thickness up to 1.2 mm

Lampholder foot/luminaire: IP40

Weight: 5.9/5.7 g, unit: 1000 pcs.

Type: 24360/24350

Ref. No.: 537155 lamp axis H: 30 mm

Ref. No.: 537153 lamp axis H: 23.5 mm

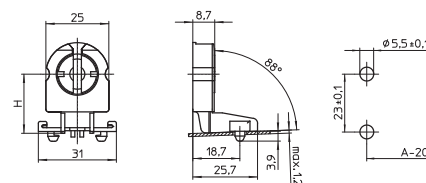

9

10

Lampholders and Accessories for T Lamps

G13 Rotoclic push-fit lampholders for lamps T8 T140, nominal rating: 2/500

Suitable for Top Test

Lateral push-in terminals: 0.5–1 mm²

Base split pins for wall thickness up to 1.2 mm

Lampholder foot/luminaire: IP40

Weight: 6/5.8/5.3 g, unit: 1000 pcs.

Type: 23360/23350/23370

Ref. No.: 537160 lamp axis H: 30 mm

Ref. No.: 537157 lamp axis H: 23.5 mm

Ref. No.: 539128 lamp axis H: 18 mm

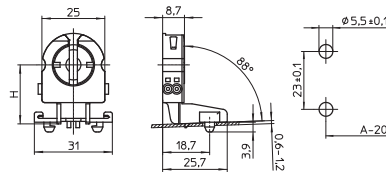

G13 push-fit lampholders with starter attachment for lamps T8

T130, nominal rating: 2/250

Base push-in terminals: 0.5–1 mm²

Base split pins for wall thickness up to 1.2 mm

Lampholder foot/luminaire: IP40

Weight: 9.7/9.5 g, unit: 1000 pcs.

Type: 27460/27450

Ref. No.: 100559 lamp axis H: 30 mm

Ref. No.: 100557 lamp axis H: 23.5 mm

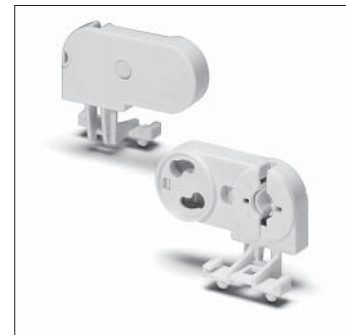
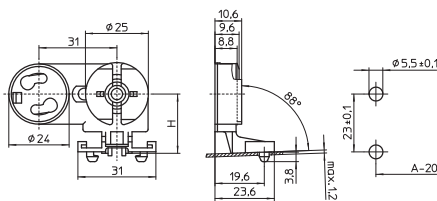

G13 push-fit lampholders for lamps T8 and T12

Lamp axis H: 25 mm

T130, nominal rating: 2/500

Base push-in terminals: 0.5–1 mm²

Push-fit foot for luminaire cut-out 13.3x25.5 mm with wall thickness 0.5–1 mm

Lampholder foot/luminaire: IP40

Weight: 5/11 g, unit: 500 pcs.

Type: 28100/28200

Ref. No.: 100585

Ref. No.: 100588 with starter attachment

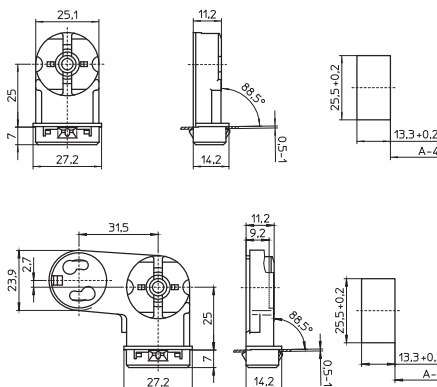

G13 push-fit lampholder for lamps T8

For the automatic luminaire wiring

Lamp axis: 31 mm

T130, nominal rating: 2/500

IDC terminals for leads H05V-U 0.5

Base split pins for wall thickness up to 1 mm

Weight: 7.2 g, unit: 1000 pcs.

Type: 28310

Ref. No.: 506007

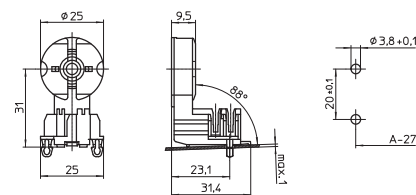

G13 push-fit lampholder for lamps T8

For the automatic luminaire wiring

Lamp axis: 26.5 mm

T130, nominal rating: 2/500

IDC terminals for leads H05V-U 0.5

Base split pins for wall thickness up to 1 mm

Weight: 7.1 g, unit: 1000 pcs.

Type: 28315

Ref. No.: 504202

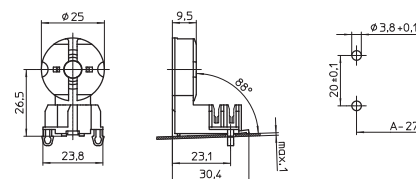

Lampholders and Accessories for T Lamps

G13 push-fit lampholder for lamps T8

For the automatic luminaire wiring

Lamp axis: 31 mm

T130, nominal rating: 2/500

IDC terminals for leads H05V-U 0.5

Lateral push-in twin terminals: 0.5–1 mm²

Base split pins for wall thickness up to 1 mm

Front cable holder for up to 3 individual conductors

Weight: 8 g, unit: 1000 pcs.

Type: 28330

Ref. No.: 508423

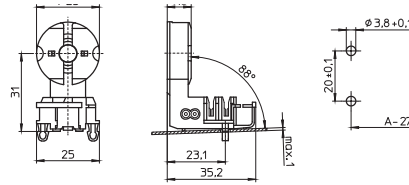

1

2

G13 push-fit lampholders

Lamp axis: 25 mm

T130, nominal rating: 5/500

Lateral and base push-in terminals: 0.5–1 mm²

Push-fit foot for luminaire cut-out 10x20 mm

for wall thickness 0.4–1 mm

Weight: 6/8.5 g, unit: 500 pcs.

Type: 28921/28920

Ref. No.: 108438 for lamps T8 and T12

Ref. No.: 108437 for lamps T8

with starter attachment

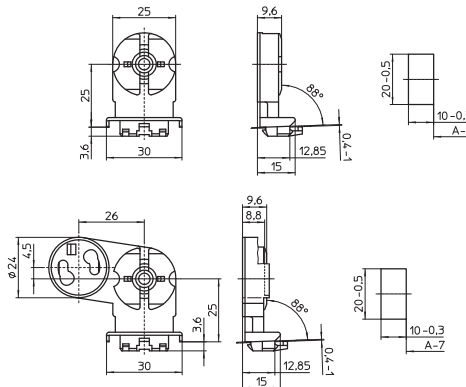

3

4

5

6

7

8

9

10

G13 Push-fit Twin Lampholders, Accessories

For fluorescent lamps T8 (T26), T12 (T38)

Casing: PC, white, rotor: PBT GF, white
 Pin support for reliable contact
 Max. permitted temperature T_m
 on the rear side of the lampholder: 110 °C

G13 twin lampholder for lamps T8

Lamp axis: 22 mm

Distance between two lamp axes: 50 mm

T130, nominal rating: 2/500

Base wiring

Push-in terminals: 0.5–1 mm²

Push-fit foot for wall thickness 1 mm

Weight: 14 g, unit: 400 pcs.

Type: 22900

Ref. No.: 108984

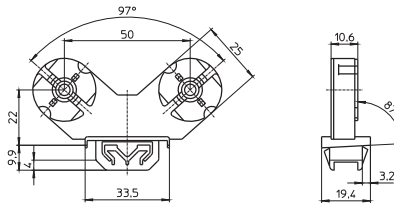

G13 twin lampholders for lamps T8 and T12

Lamp axis: 25 mm

Distance between two lamp axes: 76 mm

T130, nominal rating: 2/500

Base push-in twin terminals: 0.5–1 mm² (lamp circuit)

Base push-in terminals: 0.5–1 mm² (starter circuit)

Push-fit foot for wall thickness 0.6–1 mm

Weight: 21 g, unit: 200/500 pcs.

Type: 22604/22602 without starter attachment

Ref. No.: 108816 with stop

Ref. No.: 100487 without stop

Type: 22600/22601 with starter attachment

Ref. No.: 100484 with stop

Ref. No.: 100486 without stop

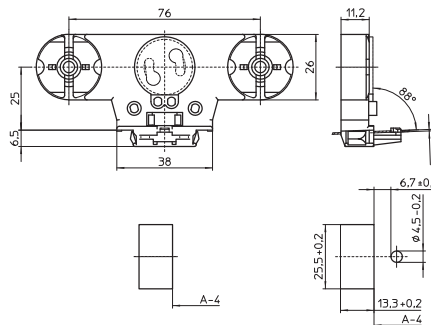

G13 twin lampholders for lamps T8 and T12

Lamp axis: 31.5 mm

Distance between two lamp axes: 76 mm

T130, nominal rating: 2/500

For wiring inserts 108777/108778

and 545261/545262

Weight: 17 g, unit: 250 pcs.

Type: 22800/22801

Ref. No.: 108773 with starter attachment

Ref. No.: 108775 without starter attachment

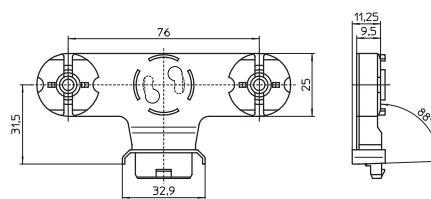

Wiring inserts with push-fit foot

For G13 twin lampholders 108773/108775

Material: PC, white

Push-in terminals: 0.5 mm²

For the automatic luminaire wiring:

IDC terminals for leads H05V-U 0.5

Weight: 5.3 g, unit: 500 pcs.

Type: 22850/22851

Ref. No.: 108777 with stop

Ref. No.: 108778 without stop

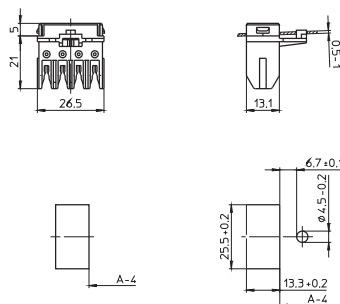

Lampholders and Accessories for T Lamps

Wiring inserts with push-fit foot
 For G13 twin lampholders 108773/108775
 Material: PC, white
 Push-in terminals: 0.5–1 mm²
 Weight: 4.4 g, unit: 500 pcs.
 Type: 22860/22861

Ref. No.: 545261 with stop
Ref. No.: 545262 without stop

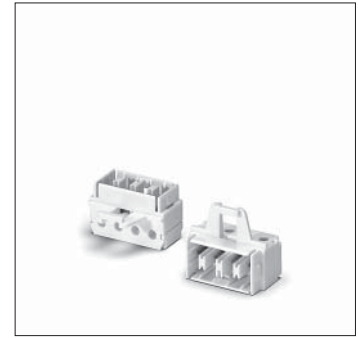
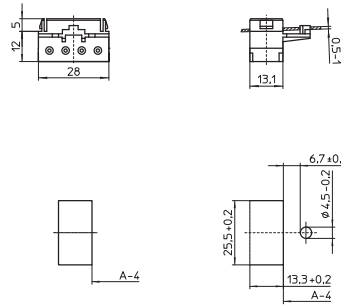

1

2

G13 Built-in Lampholders

For fluorescent lamps T8 (T26), T12 (T38)

Lampholders with integrated starter holder
 are equipped with big rotor and have
 push-in twin terminals for the lamp circuit and
 push-in terminals for the the starter circuit.
 Pin support for reliable contact
 (except for type 485)
 Casing: PC, white, frontplate/rotor: PBT GF, white
 Max. permitted temperature T_m
 on the rear side of the lampholder: 110 °C
 T-Marking acc. to IEC

G13 built-in lampholders for lamps T8 and T12
 Lampholder thickness: 13 mm
 T140, nominal rating: 2/500
 Push-in terminals: 0.5–1 mm²
 Rear split pins for wall thickness up to 1.2 mm
 Weight: 4.6/5.4 g, unit: 1000 pcs.
 Type: 47105/47106

Ref. No.: 509152
Ref. No.: 509154 with spring adjustment

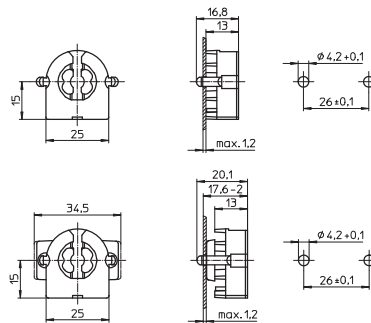

4

5

6

G13 built-in lampholders for lamps T8 and T12
 Lampholder thickness: 9.5 mm
 T140, nominal rating: 2/500
 Push-in terminals: 0.5–1 mm²
 Rear split pins for wall thickness up to 1.2 mm
 Weight: 4.4/5.1 g, unit: 1000 pcs.
 Type: 47505/47506

Ref. No.: 509162
Ref. No.: 509164 with spring adjustment

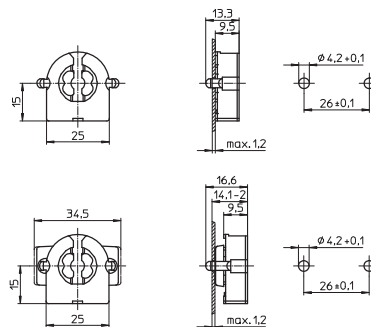

7

8

G13 built-in lampholder for lamps T8 and T12
 Lampholder thickness: 10.5 mm
 T140, nominal rating: 2/500
 Push-in terminals: 0.5–1 mm²
 Weight: 4.6 g, unit: 1000 pcs.
 Type: 47304

Ref. No.: 509156

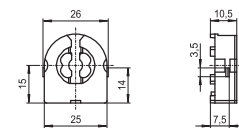

9

10

Lampholders and Accessories for T Lamps

G13 Rotoclic built-in lampholders for lamps T8 and T12
T140, nominal rating: 2/500

Base push-in terminals: 0.5–1 mm²

Fixing holes \varnothing 3.2 mm

Weight: 5 g, unit: 1000 pcs.

Type: 49100/49500

Ref. No.: 537165 lampholder thickness: 13 mm

Ref. No.: 537173 lampholder thickness: 9.5 mm

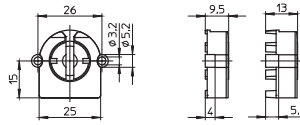

G13 built-in lampholders with spring adjustment
for lamps T8 and T12

T130, nominal rating: 2/500

Base push-in terminals: 0.5–1 mm²

Fixing holes for screws M3

Weight: 6/5.5 g, unit: 1000 pcs.

Type: 47102/47502

Ref. No.: 101681 lampholder thickness: 13 mm

Ref. No.: 101740 lampholder thickness: 9.5 mm

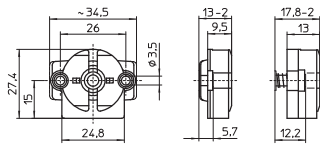

G13 Rotoclic built-in lampholders for lamps T8 and T12
T140, nominal rating: 2/500

Lateral push-in terminals: 0.5–1 mm²

Suitable for Top Test

Fixing holes \varnothing 3.2 mm

Weight: 5/4.7 g, unit: 1000 pcs.

Type: 59100/59500

Ref. No.: 537181 lampholder thickness: 13 mm

Ref. No.: 537205 lampholder thickness: 9.5 mm

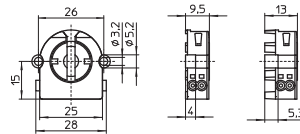

G13 built-in lampholders with starter attachment
for lamps T8 and T12

T130, nominal rating: 2/500

Base push-in terminals: 0.5–1 mm²

Fixing holes for screws M3

Weight: 8.7/8 g, unit: 1000 pcs.

Type: 47200 lampholder thickness: 13 mm

Ref. No.: 101706

Type: 47600 lampholder thickness: 9.5 mm

Ref. No.: 101765

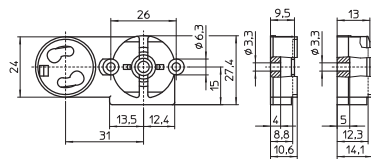

G13 Rotoclic built-in lampholders for lamps T8 and T12
T140, nominal rating: 2/500

Base push-in terminals: 0.5–1 mm²

Rear split pins for wall thickness up to 1.2 mm

Weight: 5.1/5.9/5/5.5 g, unit: 1000 pcs.

Type: 49105/49106 lampholder thickness: 13 mm

Ref. No.: 537166

Ref. No.: 537167 with spring adjustment

Type: 49505/49506 lampholder thickness: 9.5 mm

Ref. No.: 537174

Ref. No.: 537175 with spring adjustment

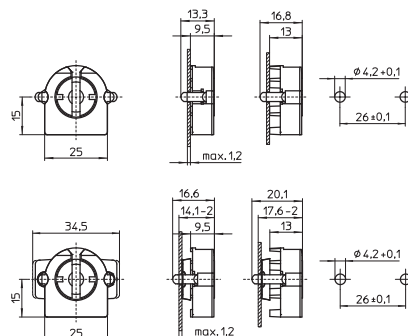

Lampholders and Accessories for T Lamps

G13 Rotoclic built-in lampholders for lamps T8 and T12 T140, nominal rating: 2/500

Lateral push-in terminals: 0.5–1 mm², suitable for Top Test
Rear split pins for wall thickness up to 1.2 mm
Weight: 5.1/5.9/5/5.5 g, unit: 1000 pcs.

Type: 59105/59106 lampholder thickness: 13 mm

Ref. No.: 537182

Ref. No.: 537183 with spring adjustment

Type: 59505/59506 lampholder thickness: 9.5 mm

Ref. No.: 537206

Ref. No.: 537207 with spring adjustment

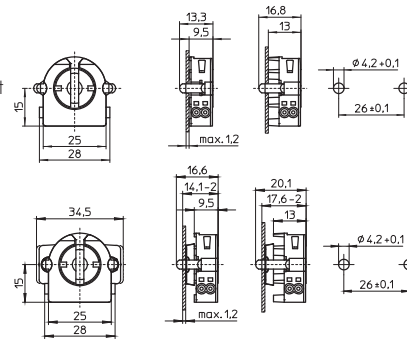

1

2

G13 built-in lampholders with starter attachment for lamps T8 and T12, T130, nominal rating: 2/500

Base push-in terminals: 0.5–1 mm²

Rear split pins for wall thickness up to 1.2 mm

Weight: 9/9.5/8/8.5 g, unit: 1000 pcs.

Type: 47205/47206 lampholder thickness: 13 mm

Ref. No.: 101712

Ref. No.: 101716 with spring adjustment

Type: 47605/47606 lampholder thickness: 9.5 mm

Ref. No.: 101769

Ref. No.: 101773 with spring adjustment

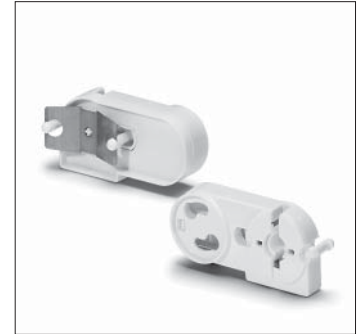
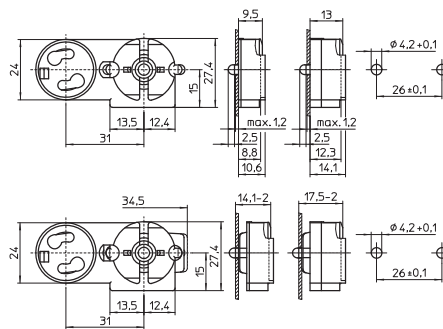

3

4

G13 built-in lampholder for lamps T8 and T12

Lampholder thickness: 10.7 mm

T130

Nominal rating: 2/500

Push-in terminals: 0.5–1 mm²

Lateral fixing clips

Weight: 4.7 g, unit: 1000 pcs.

Type: 47504

Ref. No.: 101745

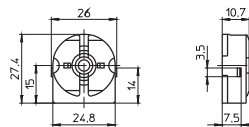

5

6

G13 lampholder

For push-fitting onto lamps T12

Lampholder thickness: 9.5 mm

Casing: PC, white, T110

Front cover plate: PBT GF, white

Nominal rating: 2/250

Push-in terminals: 0.5–1 mm²

Fixing holes for screws M3

Weight: 10.5 g, unit: 1000 pcs.

Type: 47700

Ref. No.: 101781

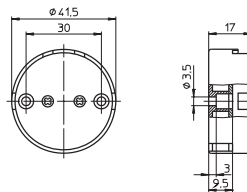

7

8

G13 lampholder

For push-fitting onto lamps T8

Lampholder thickness: 9.5 mm

Casing: PC, white, T110

Front cover plate: PBT GF, white

Nominal rating: 2/500

Push-in terminals: 0.5–1 mm²

Fixing hole for screw M3

Weight: 5.3 g, unit: 1000 pcs.

Type: 47900

Ref. No.: 101784

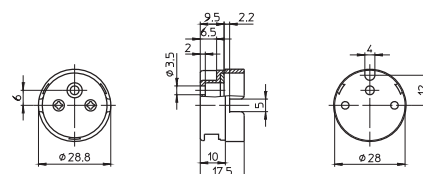

9

10

Lampholders and Accessories for T Lamps

G13 lampholder with starter attachment

For push-fitting onto lamps T8
 Lampholder thickness: 9.5 mm
 Casing: PC, white, T110
 Front cover plate: PBT GF, white
 Nominal rating: 2/250
 Push-in terminals: 0.5–1 mm²
 Fixing hole for screw M3
 Weight: 8.1 g, unit: 1000 pcs.
 Type: 47920

Ref. No.: 101785

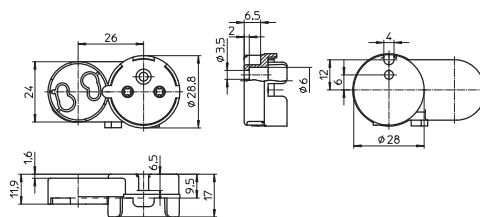

G13 built-in lampholder with lamp lock

for lamps T8 and T12
 Contacts on both sides
 Casing: PBT GF, white, T130, nominal rating: 2/500
 Screw terminals: 0.5–2.5 mm²
 Fixing holes for screws M3
 Weight: 12.9/18 g, unit: 500 pcs.
 Type: 46100/46101

Ref. No.: 101643

Ref. No.: 101647 with spring adjustment

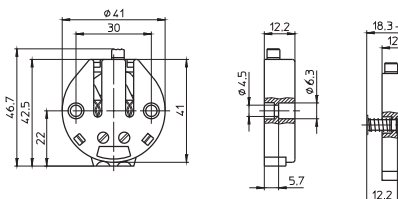

G13 built-in lampholders for lamps T8 and T12

Casing: PC, white, T110
 Nominal rating: 2/500
 Screw terminals: 0.5–2.5 mm²
 Fixing holes for screws M3
 5 rotation stops
 Weight: 9/10.6 g, unit: 1000 pcs.
 Type: 48500/48501

Ref. No.: 101787

Ref. No.: 101789 with spring adjustment

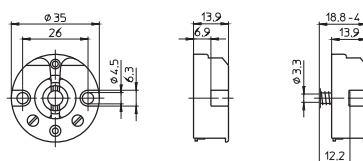

G13 Surface-mounted Lampholders

For fluorescent lamps T8 (T26), T12 (T38)

Pin support for reliable contact
(except for type 485)

Max. permitted temperature T_m
on the rear side of the lampholder: 110 °C

G13 surface-mounted lampholder for lamps T8 and T12

Lamp axis: 25.5 mm

Casing: PC, white, rotor: PBT GF, white, T130

Nominal rating: 2/500

Push-in twin terminals: 0.5–1 mm²

Fixing hole: \varnothing 3.8 mm

Weight: 7.2 g, unit: 500 pcs.

Type: 27722

Ref. No.: 100572

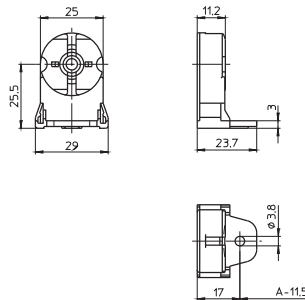

G13 surface-mounted lampholder with starter attachment
for lamps T8 and T12

Lamp axis: 25.5 mm

Casing: PC, white, rotor: PBT GF, white, T130

Nominal rating: 2/500

Push-in twin terminals: 0.5–1 mm²

Fixing hole: \varnothing 3.8 mm

Weight: 9.5 g, unit: 500 pcs.

Type: 27822

Ref. No.: 100583

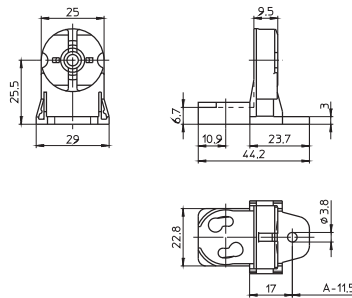

G13 surface-mounted lampholder for lamps T8

Lamp axis: 17 mm

Casing: PC, white, rotor: PBT GF, white, T130

Nominal rating: 2/250

Push-in twin terminals: 0.5–1 mm²

Fixing hole for self-tapping screw
acc. to ISO 1481/7049-ST3.5-C/F

Weight: 5.4 g, unit: 1000 pcs.

Type: 27356

Ref. No.: 100551

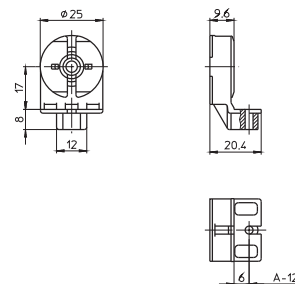

G13 surface-mounted lampholders
for lamps T8 and T12

Lamp axis: 25 mm, casing: PC, white, T110

Screw terminals: 0.5–2.5 mm², nominal rating: 2/500

Bracket: zinc-coated polished steel

Fixing slots for screws M4

5 rotation stops

Weight: 26/28.1 g, unit: 500 pcs.

Type: 48502/48503

Ref. No.: 101791

Ref. No.: 101793 with spring adjustment

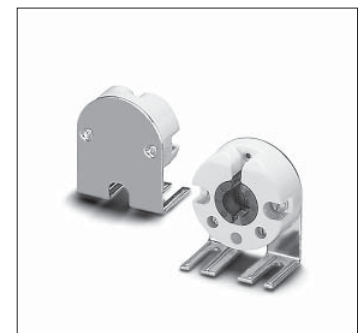
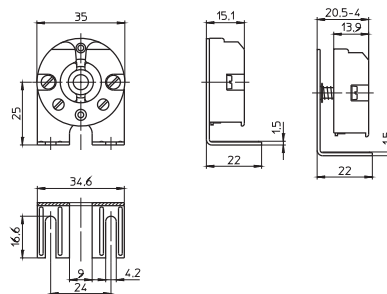

Accessories

For lampholders for fluorescent lamps T8 (T26), T12 (T38)

The luminaire manufacturer is responsible for the right choice of accessories.

Lamp supports

Fixing hole for screw M4

Weight: 4.3/6.8 g, unit: 500 pcs.

Type: 20400 for lamps T8

Ref. No.: 100442

material: zinc-coated polished steel

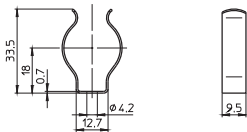

Lamp supports for lamps T8

Material: PC, crystal-clear

Fixing hole for screw M4

Weight: 2 g, unit: 1000 pcs.

Type: 20501

Ref. No.: 100448

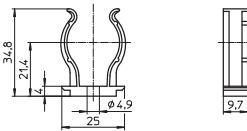

Push-fit bracket

For G13 built-in lampholder 537174, 537206

(see p. 188, 189) and starter holder 101627 and 109792 (see p. 201, 202), material: PC, white

Lamp axis optional: 46/51/56 mm

or 43 mm (lateral lamp insertion)

Push-fit foot for wall thickness 0.5–1 mm

Option for lateral or base wiring

Weight: 5.3 g, unit: 1000 pcs.

Type: 97532

Ref. No.: 105843

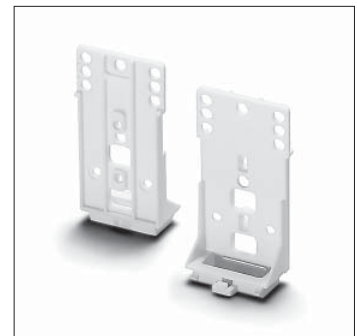
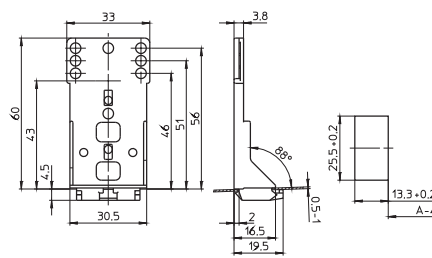

Push-fit bracket

For G13 built-in lampholder 537181, 537166,

537174 (see p. 188), 537206 (see p. 189)

Material: PC, grey

Lamp axis optional: 33/40/46/51/56

or 43 mm (lateral lamp insertion)

Push-fit foot for wall thickness 0.5–1 mm

Weight: 6 g, unit: 1000 pcs.

Type: 97044

Ref. No.: 108780

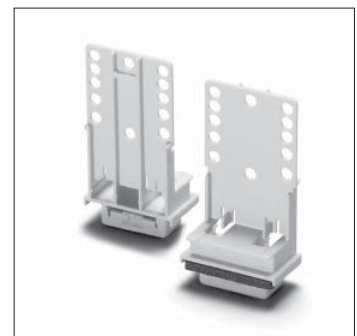
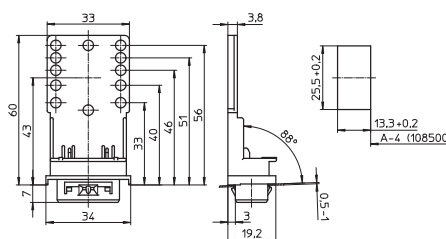

Lampholders and Accessories for T Lamps

Foot gasket for degree of protection IP50

For push-fit bracket 108780

Material: EPDM, black

Weight: 0.7 g

Type: 98003

Ref. No.: 108266

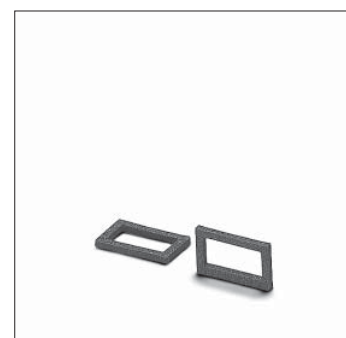
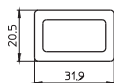

1

Cable holder

Material: PA, white

Push-fit foot for cut-out \varnothing 4 mm

for wall thickness 0.6–1.2 mm

Weight: 0.2 g, unit: 5000 pcs.

Type: 97147

Ref. No.: 109086

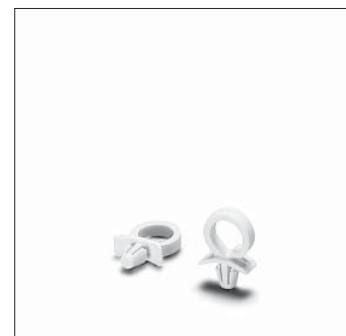
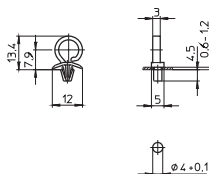

2

3

4

Cable holder

For the automatic luminaire wiring and manual wiring

Material: PC, white

Degree of protection IP50

Weight: 0.5 g, unit: 5000 pcs.

Type: 97117

Ref. No.: 108845

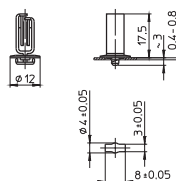

5

6

Cable holder

For the automatic luminaire wiring and manual wiring

Material: PA, white

Weight: 2.1 g, unit: 7500 pcs.

Type: 0607

Ref. No.: 159968

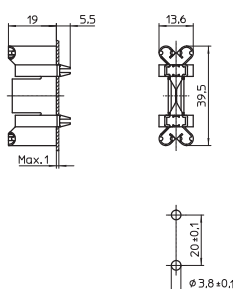

7

8

9

10

G13 Lampholders, Degree of Protection IP54

**For fluorescent lamps T8 (T26), T12 (T38)
For luminaires of protection class I and II**

Lampholders protected against dust and splashing water (IP54)
To convert luminaires from IP20 to IP54
Pin support for reliable contact
With spring adjustment

Max. permitted temperature T_m
on the rear side of the lampholder: 110 °C

G13 push-fit lampholder for lamps T8/T12
Casing: PC, white, interior part: PBT GF, white
Rotor: PBT GF, white, T140
Nominal rating: 2/500
Push-in terminals: 0.5–1 mm²
Fixing clips for wall thickness 0.7 mm
Screw rings see page 197
Weight: 17.1 g, unit: 500 pcs.
Type: 84171 system 161
Ref. No.: 107957

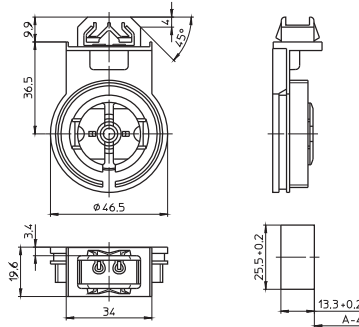

G13 push-fit twin lampholder for lamps T8/T12
Casing: PC, white, interior part: PBT GF, white
Rotor: PBT GF, white, T140
Nominal rating: 2/500
Push-in terminals: 0.5–1 mm²
Fixing clips for wall thickness 0.7 mm
Screw rings see page 197
Weight: 33.6 g, unit: 250 pcs.
Type: 84173 system 162
Ref. No.: 107959

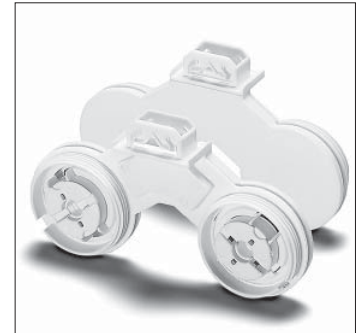
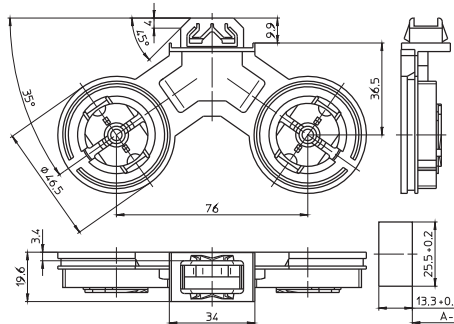

Food gasket for degree of protection IP54
For lampholder systems 161, 162
Material: EPDM, black
Weight: 0.7 g
Type: 98003
Ref. No.: 108266

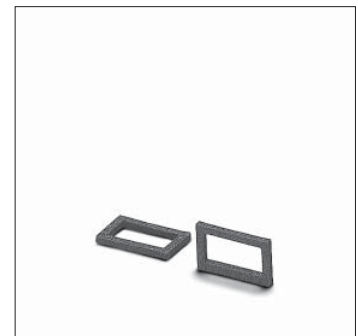
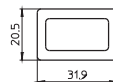

G13 Lampholders, Degree of Protection IP65/IP67

**For fluorescent lamps T8 (T26), T12 (T38)
For luminaires of protection class I and II**

Lampholders protected against dust and jet of water (IP65)
Dust and watertight lampholders (IP67)
Pin support for reliable contact with spring adjustment

Max. permitted temperature T_m
on the rear side of the lampholder: 110 °C

G13 push-fit lampholders for lamps T8/T12
Casing: PC, interior part: PBT GF
Rotor: PBT GF, white, T140
Nominal rating: 2/500
Push-in terminals: 0.5–1 mm²
Fixing clips for wall thickness 1.4–2 mm
Screw rings see page 197
Weight: 17.3 g, unit: 500 pcs.
Type: 84172 system 163
Ref. No.: 107958 casing white
Ref. No.: 108666 casing grey

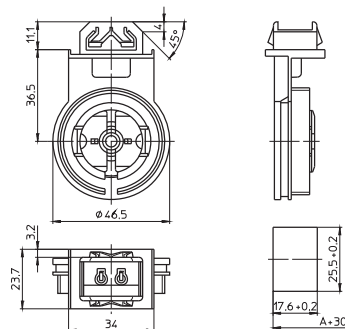

G13 push-fit twin lampholders for lamps T8/T12
Casing: PC, interior part: PBT GF
Rotor: PBT GF, white, T140
Nominal rating: 2/500
Push-in terminals: 0.5–1 mm²
Fixing clips for wall thickness 1.4–2 mm
Screw rings see page 197
Weight: 34.2 g, unit: 250 pcs.
Type: 84174 system 164
Ref. No.: 107960 casing white
Ref. No.: 108669 casing grey

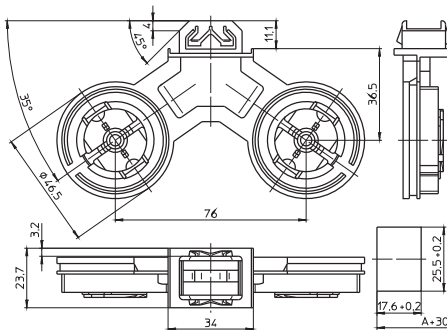

G13 push-fit lampholders for lamps T8/T12
Casing: PC, interior part: PBT GF, T140
Nominal rating: 2/500
Push-in terminals: 0.5–1 mm²
Fixing clips for wall thickness 1.4–2 mm
With slot insertion
Screw rings see page 197
Weight: 14.5 g, unit: 250 pcs.
Type: 84175 system 165
Ref. No.: 108608 casing white
Ref. No.: 108614 casing grey

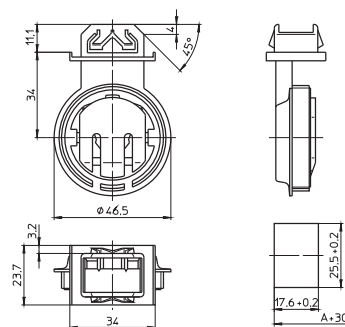

Foot gaskets
For lampholder systems 163, 164, 165
Weight: 1/1.1 g
For degree of protection IP65
Material: cellular rubber
Type: 98004
Ref. No.: 108267
For degree of protection IP67
Material: silicone, transparent
Type: 98011
Ref. No.: 504078

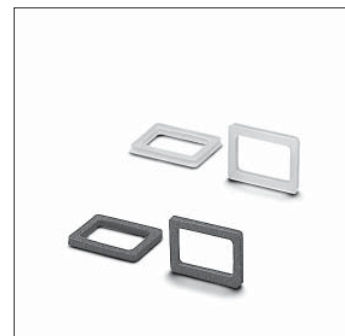
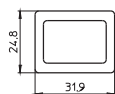

1

2

3

4

5

6

7

8

9

10

Lampholders and Accessories for T Lamps

Profiled foot gasket
 For degree of protection IP67
 For lampholder systems 163, 164, 165
 Material: EPDM, black
 Weight: 1.1 g, unit: 1000 pcs.
 Type: 98008

Ref. No.: 546254

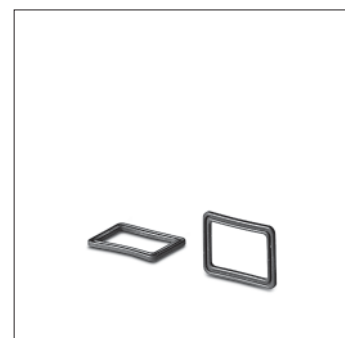
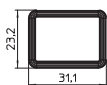

Foot gasket, profiled shape
 For degree of protection IP67
 For lampholder systems 167, 168
 Material: EPDM, black
 Weight: 0.7 g, unit: 1000 pcs.
 Type: 98087

Ref. No.: 503773

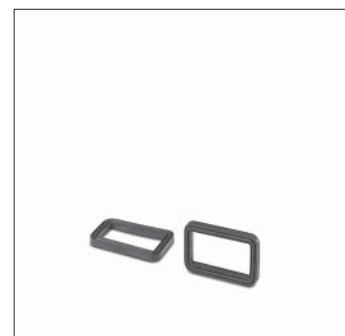
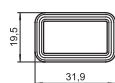

G13 lampholder for lamps T8/T12
 Casing: PC, white, interior part: PBT GF, T140
 Nominal rating: 2/500
 Screw fixing foot with tapped holes M4
 Screw rings see page 197
 With slot insertion
 Weight: 14 g, unit: 250 pcs.
 Type: 84105 system 152

Ref. No.: 521123

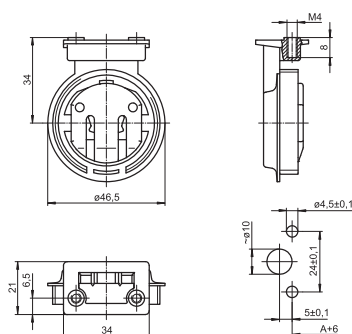

Foot gasket for degree of protection IP65/IP67
 For lampholder system 152
 Material: EPDM, black
 Weight: 1.4 g, unit: 1000 pcs.
 Type: 98085

Ref. No.: 106094

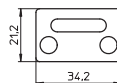

Screw Rings for G13 Lampholders, Degree of Protection IP54, IP65, IP67

For lampholder systems 152, 161, 162, 163, 164, 165

Screw rings

Ring: PBT GF, gasket: silicone

Weight: 17/20 g, unit: 500/250 pcs.

Type: 84122 for lamps T8

Ref. No.: 103710 white

Ref. No.: 103709 grey

Type: 84123 for lamps T12 or

for lamps T8 with protection tube \varnothing 38 mm

Ref. No.: 103712 white

Ref. No.: 103711 grey

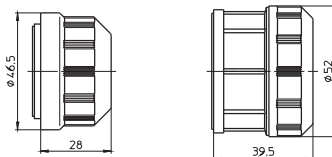

Screw rings with heat dissipator

For lamps T8 with

plastic protection tube \varnothing 38 mm

Ring: PBT GF

Gasket: silicone, shell: aluminium

Weight: 40 g, unit: 250 pcs.

Type: 84154

Ref. No.: 103744 white

Ref. No.: 103743 grey

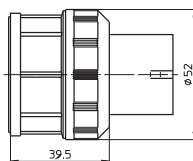

1

2

3

4

5

6

7

8

9

10

OPTIMUM START WITH COMPONENTS MADE BY VS



STARTER HOLDERS AND TERMINAL BLOCKS, ACCESSORIES

Vossloh-Schwabe provides a comprehensive range of miscellaneous accessories for operating fluorescent lamps.

Starter holders

Starters are needed for lamp circuits operated with electromagnetic ballasts. VS provides a number of starter holders with various designs for this purpose. Almost all starter holders are made of polycarbonate and qualify for a T110 temperature rating.

Terminal blocks

Furthermore, Vossloh-Schwabe's product range also includes connection terminals, some of which feature the VDE-approved IDC method in addition to the well-known and installation-friendly push-in connectors. The connection terminals therefore make it possible to automate luminaire wiring and thus wire up several terminals using a single cable.

The range is rounded off by built-in rocker switches.

3

Starter Holders and Terminal Blocks, Accessories

Starter holders, accessories	200-203
Terminal blocks, accessories	204-206
Built-in rocker switches	207
Technical details for fluorescent lamps	208-235
General technical details	348-356
Glossary	357-359

1

2

3

4

5

6

7

8

9

10

Starter Holders, Accessories

For starters acc. to DIN VDE 0712 part 101, IEC 60155

Starter holders with central studs, suitable for luminaires of protection class II, are available on request.

Starter holder

Material: PC, white

T110, nominal rating: 2/250

Push-in terminals: 0.5–1 mm²

Rear split pins for wall thickness up to 1.2 mm

Weight: 2.1 g, unit: 1000 pcs.

Type: 02113

Ref. No.: 535131

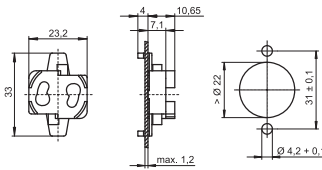

Starter holder

Material: PC, white

T110, nominal rating: 2/250

Push-in terminals: 0.5–1 mm², single-core

Front and rear split pins for wall thickness up to 1.2 mm

Rear of starter holder/luminaire: IP40

Weight: 2.8 g, unit: 1000 pcs.

Type: 02110

Ref. No.: 109784

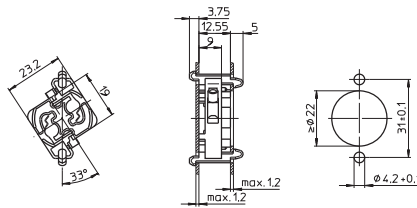

Starter holder

Material: PC, white

T110, nominal rating: 2/250

Push-in terminals: 0.5–1 mm²

Rear split pins for wall thickness up to 1.2 mm

Lateral split pins for wall thickness up to 1.25 mm

Rear of starter holder/luminaire: IP40

Weight: 3.7 g, unit: 1000 pcs.

Type: 02120

Ref. No.: 100064

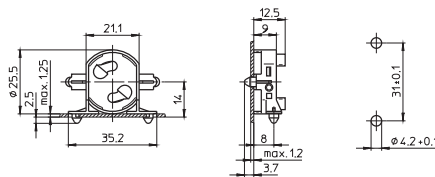

Starter holder

Material: PC, white

T110, nominal rating: 2/250

Push-in terminals: 0.5–1 mm²

Fixing holes for screws M3

Weight: 3.8 g, unit: 1000 pcs.

Type: 02150

Ref. No.: 100069

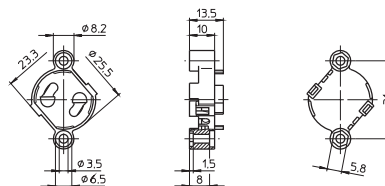

Starter Holders and Terminal Blocks, Accessories

Starter holder

Material: PC, white

T110, nominal rating: 2/250

Push-in terminals: 0.5–1 mm²

Front split pins, flat
for wall thickness 0.6–1 mm

Weight: 3.1 g, unit: 1000 pcs.

Type: 02170

Ref. No.: 106818

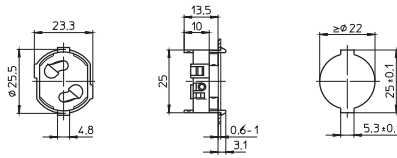

1

2

Starter holder

Material: PC, white

T110, nominal rating: 2/250

Push-in terminals: 0.5–1 mm²

Rear split pins for wall thickness up to 1.2 mm

Rear of starter holder/luminaire: IP40

Weight: 3.3 g, unit: 1000 pcs.

Type: 43000

Ref. No.: 101627

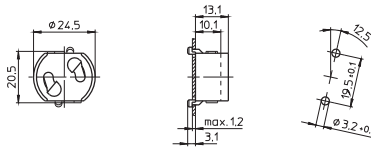

3

4

Starter holder

Material: PC, white

T110, nominal rating: 2/250

Push-in terminals: 0.5–1 mm²

Lateral split pins for wall thickness up to 1 mm

Rear of starter holder/luminaire: IP40

Weight: 3.4 g, unit: 1000 pcs.

Type: 43010

Ref. No.: 101629

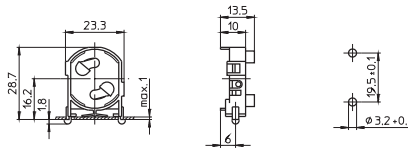

5

6

Starter holder

Material: PC, white

T110, nominal rating: 2/250

Push-in terminals: 0.5–1 mm²

Rear and lateral split pins

for wall thickness up to 1 mm

Rear of starter holder/luminaire: IP40

Weight: 3.5 g, unit: 1000 pcs.

Type: 43020

Ref. No.: 108671

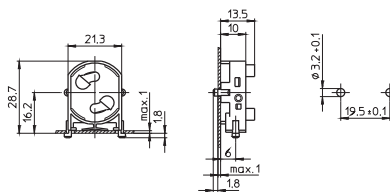

7

8

Starter holder

Material: PC, white

T110, nominal rating: 2/250

Push-in terminals: 0.5–1 mm²

Fixing holes for screws M3

Weight: 3.7 g, unit: 1000 pcs.

Type: 43100

Ref. No.: 101631

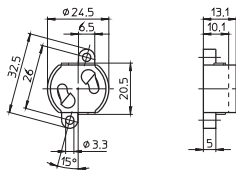

9

10

Starter Holders and Terminal Blocks, Accessories

Starter holder

Material: PC, white

T110, nominal rating: 2/250

Push-in terminals: 0.5–1 mm², single-core

Lateral split pins for wall thickness up to 1 mm

Rear of starter holder/luminaire: IP40

Weight: 3.7 g, unit: 1000 pcs.

Type: 43200

Ref. No.: 109790

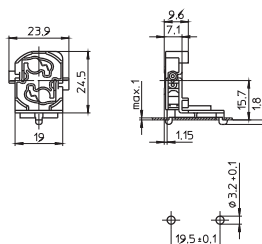

Starter holder

Material: PC, white

T110, nominal rating: 2/250

Push-in terminals: 0.5–1 mm², single-core

Rear split pins for wall thickness up to 1.2 mm

Lateral split pins for wall thickness up to 1 mm

Rear of starter holder/luminaire: IP40

Weight: 3.7 g, unit: 1000 pcs.

Type: 43210

Ref. No.: 109792

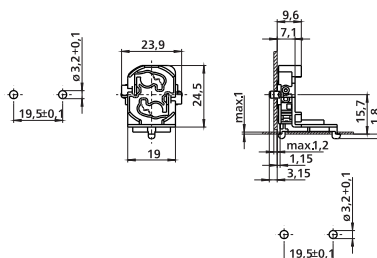

Starter holder with integrated extension piece

Material: PC, white

T110, nominal rating: 2/250

Push-in terminals: 0.5–1 mm²

Front split pins for wall thickness up to 0.8 mm

Weight: 5.4 g, unit: 1000 pcs.

Type: 43300

Ref. No.: 101636

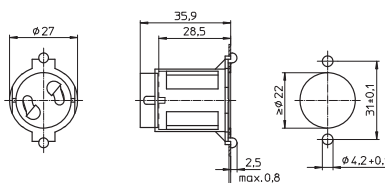

Starter holder with integrated extension piece

Material: PC, white

For the automatic luminaire wiring

T110, nominal rating: 2/250

IDC terminals for leads H05V-U 0.5

Front split pins for wall thickness up to 1 mm

Weight: 5.4 g, unit: 1000 pcs.

Type: 43500

Ref. No.: 108454

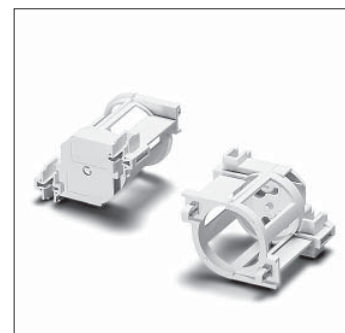
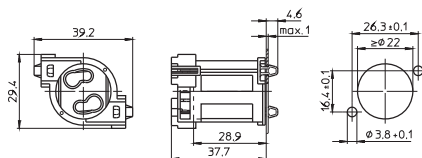

Starter holder

Material: PC, white

T110, nominal rating: 2/250

Push-in terminals: 0.5–1 mm²

For the automatic luminaire wiring:

IDC terminals for leads H05V-U 0.5

Rear split pins for wall thickness up to 1 mm

Weight: 3 g, unit: 1000 pcs.

Type: 43520

Ref. No.: 530079

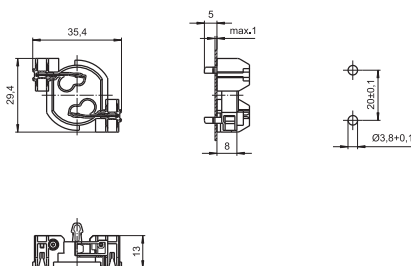

Starter Holders and Terminal Blocks, Accessories

Starter holder

Material: PA, white

T110, nominal rating: 2/250

For the automatic luminaire wiring:

IDC terminals for leads H05V-U 0.5

Lateral split pins for wall thickness up to 1 mm

Weight: 3 g, unit: 1000 pcs.

Type: 43410

Ref. No.: 107445

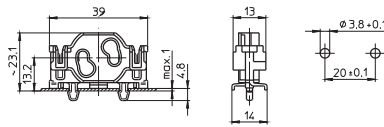

1

2

Extension piece

For front clip-in fixing into luminaire metal sheets

For use with starter holder 109784 (see p. 200)

For screw caps type 97065

Material: PC, white

Weight: 3.5 g, unit: 500 pcs.

Type: 97064

Ref. No.: 105482

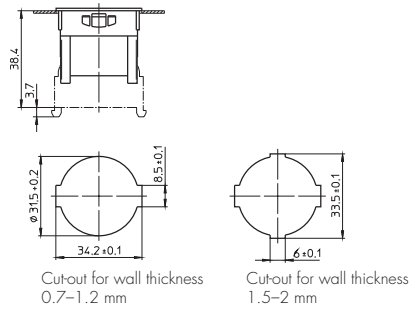

3

4

Screw caps for degree of protection IP54/IP65/IP67

For extension piece 105482

Material: PP

Gasket: EPDM cellular rubber

Weight: 3.2/4/0.3 g, unit: 500 pcs.

Type: 97065 screw cap

Ref. No.: 105483 white

Ref. No.: 109575 grey

Type: 98086 gasket

Ref. No.: 106095

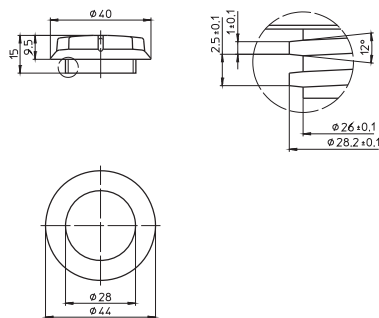

5

6

7

8

9

10

Terminal Blocks, Accessories

Suitable only for solid conductors on the secondary connection

Terminal blocks

Casing: PC, white, T85

Nominal rating: 450 V

Primary connection with release button:

push-in twin terminals 0.5–2.5 mm²/16 A

Secondary connection:

push-in twin terminals 0.5–1.5 mm²/16 A
and 0.5–2.5 mm²/16 A

Connection for X2 RFI-suppression capacitor:

0.5–0.75 mm², capacitor's pins must be insulated (stripped lead ends: 8⁺ mm)

For the automatic luminaire wiring:

IDC terminals for leads H05V-U 0.5/6 A

Base split pins for wall thickness 0.6–1 mm

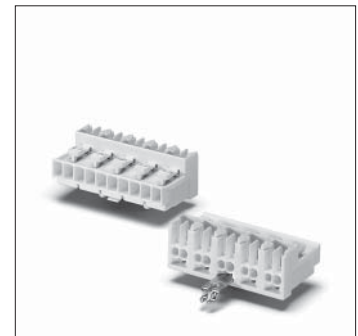
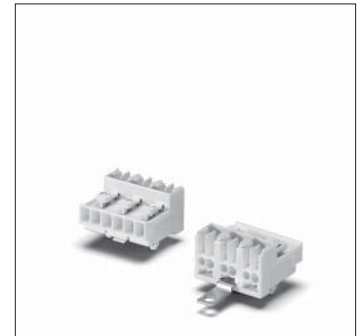
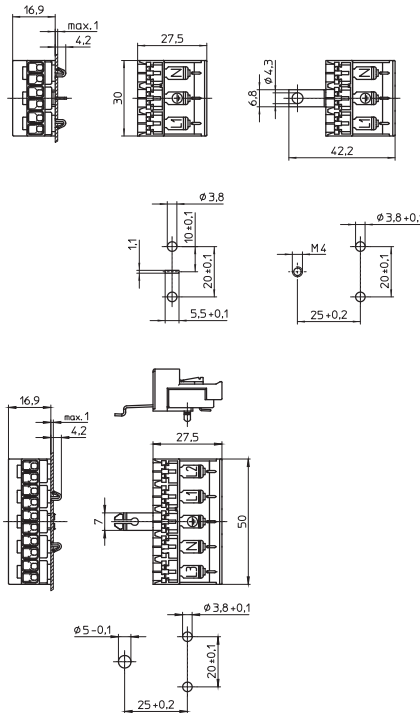

Type	Ref. No.	Number of poles	Earth-contact connection	Mark	Weight (g)	Unit (pcs.)
41500	533312	3-poles	not earthed	N, L2, L1	9.2	500
41510	533313	3-poles	earth spike	N, PE, L1	9.4	500
41520	533314	3-poles	earth strap M4	N, PE, L1	10	500
41530	534948	3-poles	earth finger	N, PE, L1	10	500
41540	533315	5-poles	not earthed	L3, L2, L4, N, L1	15.1	500
41550	533316	5-poles	earth spike	L3, L2, PE, N, L1	15.3	500
41560	533317	5-poles	earth strap M4	L3, L2, PE, N, L1	16	500
41570	534954	5-poles	earth finger	L3, L2, PE, N, L1	16	500

Push-in cord grip

For terminal blocks type 415

For leads with insulation max. Ø 10.5 mm

Conductor fixed with self-tapping screws

acc. to ISO 1481/7049-ST2.9-C/F

Material: PA, white

Weight: 2.2 g, unit: 500 pcs.

Type: 97734

Ref. No.: 535474

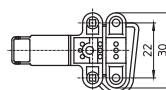
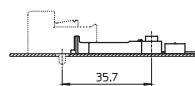

Starter Holders and Terminal Blocks, Accessories

Terminal blocks

Casing: PC, white, T85

Nominal rating: 450 V

Primary connection:

screw terminals 2.5 mm²

Secondary connection:

push-in twin terminals 1.5 mm²

(with IDC contacts: 1 mm²)

push-in terminal 0.5 mm²

For the automatic luminaire wiring:

IDC terminals for leads H05V-U 0.5

Base split pins for wall thickness 0.6–1.2 mm

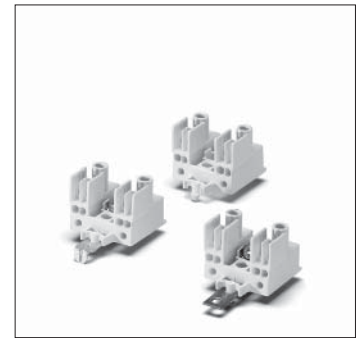
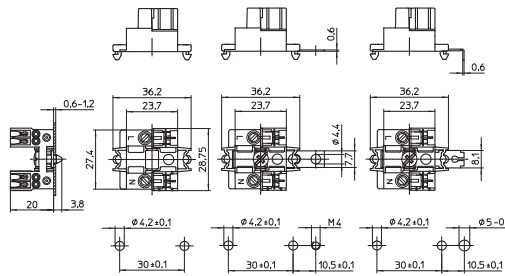

1

2

3

4

Type	Ref. No.	IDC	Number of poles	Earth-contact connection	Weight (g)	Unit (pcs.)
40660	543793	no	3-poles	not earthed	5.7	1000
40662	543795	no	3-poles	earth strap M4	8.4	1000
40666	543800	no	3-poles	earth finger	8.3	1000
40661	543794	yes	3-poles	not earthed	6	1000
40663	543796	yes	3-poles	earth strap M4	8.7	1000
40667	547801	yes	3-poles	earth finger	8.6	1000

Terminal blocks with fuse holder

Material: PC, white, T70

nominal rating: 250 V

Primary connection: screw terminals 2.5 mm²

Secondary connection:

push-in twin terminals 1.5 mm²

(with IDC contacts: 1 mm²)

push-in terminal 0.5 mm²

For the automatic luminaire wiring:

IDC terminals for leads H05V-U 0.5

With retaining clip for fuses 5x20 mm

With integrated fuse on request

Base split pins for wall thickness 0.6–1.2 mm

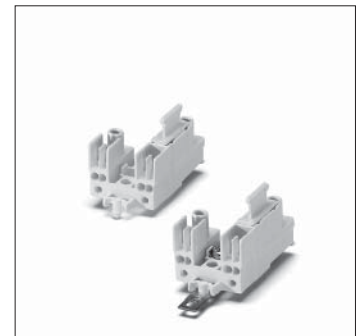
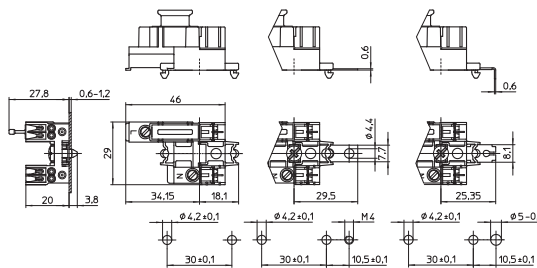

5

6

Type	Ref. No.	IDC	Number of poles	Earth-contact connection	Weight (g)	Unit (pcs.)
40670	543802	no	3-poles	not earthed	8.7	1000
40672	543805	no	3-poles	earth strap M4	11.5	1000
40676	543809	no	3-poles	earth finger	14.1	1000
40671	543803	yes	3-poles	not earthed	9.0	1000
40673	543806	yes	3-poles	earth strap M4	11.8	1000
40677	543810	yes	3-poles	earth finger	14.4	1000

7

8

9

10

Starter Holders and Terminal Blocks, Accessories

Terminal blocks

Casing: PC, grey, T85

Nominal rating: 450 V

Primary connection:

screw terminals 2.5 mm²

Secondary connection:

push-in twin terminal 1.5 mm²

(with IDC contacts: 1 mm²)

push-in terminal 0.5 mm²

For the automatic luminaire wiring:

IDC terminals for leads H05V-U 0.5

Base split pins for wall thickness 0.6–1.2 mm

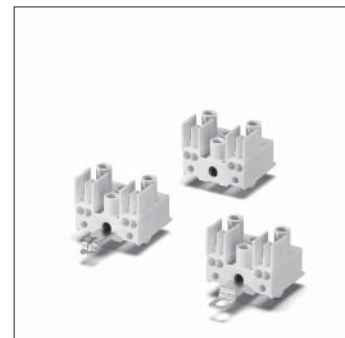
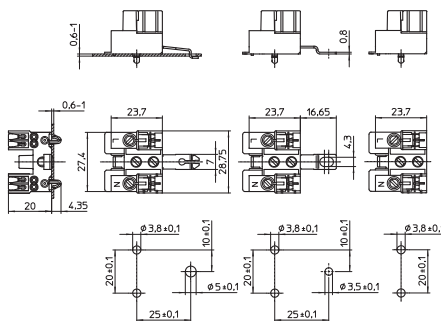

Type	Ref. No.	IDC	Type	Number of poles	Earth-contact connection	Weight (g)	Unit (pcs.)
40560	543770	no		3-poles	not earthed	8	1000
40562	543772	no		3-poles	earth strap M4	8.7	1000
40566	543777	no		3-poles	earth finger	8.8	1000
40561	543771	yes		3-poles	not earthed	8.3	1000
40563	543773	yes		3-poles	earth strap M4	9	1000
40567	543778	yes		3-poles	earth finger	9.1	1000

Terminal blocks with fuse holder

Material: PBT, grey, T70

Nominal rating: 250 V

Primary connection: screw terminals 2.5 mm²

Secondary connection:

push-in twin terminals 1.5 mm²

(with IDC contacts: 1 mm²)

push-in terminal 0.5 mm²

For the automatic luminaire wiring:

IDC terminals for leads H05V-U 0.5

With retaining clip for fuses 6x25 mm

With integrated fuse on request

Base split pins for wall thickness 0.6–1.2 mm

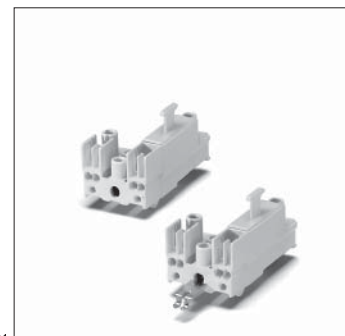
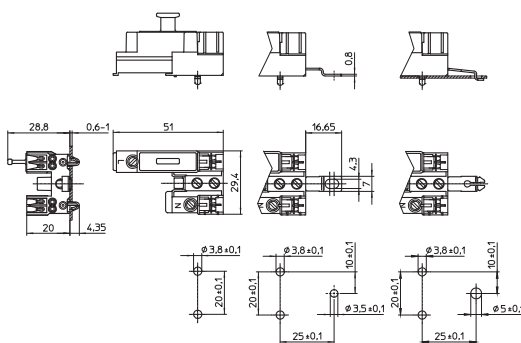

Type	Ref. No.	IDC	Type	Number of poles	Earth-contact connection	Weight (g)	Unit (pcs.)
40570	543781	no		3-poles	not earthed	11	500
40572	543783	no		3-poles	earth strap M4	11.7	500
40576	543787	no		3-poles	earth finger	11.8	500
40571	543782	yes		3-poles	not earthed	11.3	500
40573	543784	yes		3-poles	earth strap M4	12	500
40577	543788	yes		3-poles	earth finger	12.1	500

Built-in Rocker Switches

Built-in rocker switch 1-pole
 For cut-out 16x26 mm
 Casing: PC, white, T100
 Contact pillar and rocker: PBT, white
 Terminal: nichrome steel
 Nominal rating: 6(2)/250~
 Push-in terminals: 0.5–1 mm²
 Lateral fixing clips for wall thickness 0.6–1 mm
 Weight: 7.2 g, unit: 500 pcs.
 Type: 20200

Ref. No.: 100437

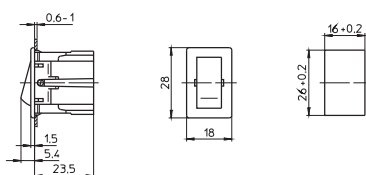

1

2

3

4

5

6

7

8

9

10

3

Components for Fluorescent Lamps

Electronic ballasts	209–223
Assembly instructions for mounting and installing – Electronic ballasts	210–216
DAI system information	217–219
Circuit diagrams – Electronic ballasts	220–223
Electromagnetic ballasts	223–227
Assembly instructions for mounting and installing – Electromagnetic ballasts	224–227
Circuit diagrams – Electromagnetic ballasts	227
Connection terminals	228
Lampholders for fluorescent lamps	229
Lamp table	230–232
Key to lamp designations	232
Energy efficiency classification	233–235
General technical details	348–356
Glossary	357–359

Ballasts for fluorescent lamps

The operation of a fluorescent lamp depends on a ballast that stabilises the lamp's preheat current after connection to the mains and, in conjunction with the starter, also supplies the required lamp ignition voltage after preheating. After ignition, the ballast then serves to limit the lamp current. As fluorescent lamps are characterised by a negative characteristic current-voltage curve, lamp current stabilisation is essential with regard to both the lamp's stable operation and a long service life, which is also dependent on compliance with the starting conditions (preheat current and ignition voltage). Unfavourable starting conditions cause damage to the electrodes every time the lamp is started and thus reduce the lamp's service life. Furthermore, care should be taken to prevent crossdischarge in the electrode area during preheating, which also shortens lamp service life.

Electromagnetic (inductive) ballasts have to be operated in conjunction with starters for lamp ignition and capacitors for blind current compensation. In addition, capacitors for RFI suppression will also be required for certain circuits. Electronic ballasts do not require any additional components.

Electronic ballasts (EB)

VS electronic ballasts are designed for mains voltages of 220 V to 240 V (exceptions are devices for the North American market where the nominal mains voltage is 120 V or 277 V) and are used to operate fluorescent lamps at high frequencies. The lamps are ignited with an internally generated ignition voltage, thereby removing the need for an external starter. The power factor (λ) > 0.95 also removes the need for compensation, unlike with electromagnetic ballasts. The only exceptions are low-output ELXs models, which attain a power factor of 0.6. Luminaires fitted with electronic ballasts are characterised by low energy consumption as they draw substantially less system power than conventional, inductive applications. This is firstly because the lamp consumes less power to achieve the same luminous flux and secondly because the internal loss of an electronic ballast only amounts to approx. 8% to 10% of the lamp's output. Furthermore, thanks to their modern circuitry, the power input of VS electronic ballasts remains constant even in the event of mains voltage fluctuations, thus ensuring permanently low energy consumption.

VS electronic ballasts permit a broad range of applications. For instance, the VS product range includes many ballast types for multiple lamp operation. These ballasts reduce installation and component costs and thus enable particularly efficient luminaires. Twin-lamp electronic ballasts permit so-called master-slave operation. The lamps of two single-lamp luminaires are operated by a twin-lamp electronic ballast that is built into the so-called master luminaire. The lamp of the slave luminaire is electrically connected to the electronic ballast.

Multi-lamp electronic ballasts also provide an interesting advantage in that several lamps of different ratings can be connected. Electronic ballasts of this kind simplify storage and logistics.

1

2

3

4

5

6

7

8

9

10

The use of electronic ballasts makes a lighting system both more convenient and efficient to operate:

- reduced power consumption (up to 30%) at undiminished light output
- 50% longer service life
- stabilised lamp output
- overvoltage protection
- no stroboscopic effect
- flicker-free lamp start
- no need for a starter or capacitor
- low wiring effort
- no radiated electromagnetic interference
- low self-heating due to minimal power loss
- automatic shutdown of defective lamps
- automatic restart once the lamp has been changed (except ELXe series)

Vossloh-Schwabe electronic ballasts are developed on the basis of the latest technological and component standards and are produced using state-of-the-art technology, whereby consideration is taken of our customers' quality standards in our quality assurance system.

Assembly Instructions for Electronic Ballasts

For mounting and installing of electronic ballasts for fluorescent lamps

Mandatory regulations

EN 61347-1	Lamp controlgear – part 1: general and safety requirements
EN 61347-2-3	Lamp controlgear – part 2-3: particular requirements for a.c. supplied electronic ballasts for fluorescent lamps
EN 60929	AC-supplied electronic ballasts for tubular fluorescent lamps
DIN VDE 0100	Erection of low voltage installations
EN 60598-1	Luminaires – part 1: general requirements and tests
EN 61000-3-2	Electromagnetic compatibility (EMC) – part 3: maximum values – main section part 2: maximum values for mains harmonics (device input current up to and including 16 A per conductor)
EN 55015	Maximum values and methods of measurement for RFI suppression in electrical lighting installations and similar electrical appliances
EN 61547	Installations for general lighting purposes – EMC immunity requirements

Descriptions of VS electronic ballasts (EBs)

ELXc ballasts (warm start)

In contrast to the ELXs series, ELXc ballasts have a power factor of better than 0.95 and cover the complete capacity range.

ELXc ballasts ensure the lamp is started following a defined lamp electrode preheating period of approx. 1–2.5 seconds using a fixed ignition voltage. This particularly gentle lamp start makes over 20,000 lamp starts possible. ELXc ballasts should be used for applications with high switching frequencies (e.g. hotels or offices) where energy savings as well as low maintenance costs are desired. The average service life of these ballasts totals 50,000 hours with a failure rate of $\leq 0.2\%$ per 1,000 operating hours. The average life of the series ECO-Effectline: 30.000 hours and New T5 Effectline: 50.000 hours with a failure rate of $\leq 0.2\%$ per 1,000 operating hours.

ELXd ballasts (dimmable)

These are warm start ballasts with an additional dimming function that is controlled via an interface fitted to the ballast. The interface of these ballasts can be either analogue (1–10 Volt) or digital (DALI; PUSH); the interface enables lighting to be ideally adjusted to suit the given need. Control components can also be used as long as they comply with the respective standard (Annex to IEC/EN 60929). The power factor for these ballasts is > 0.95 at 100% lamp operation. When using ELXd ballasts in a lighting system, an energy saving of 75% can be achieved if, for instance, the control inputs of the ballasts are coupled with movement detectors and light sensors. The average service life of these ballasts totals 50,000 hours with a failure rate of $\leq 0.2\%$ per 1,000 operating hours.

To guarantee trouble-free operation and a long service life of the various types of electronic ballast, attention should be paid to the regulations and mounting instructions (page 228–235). In addition, the installation instructions for lighting systems must be observed when installing luminaires with electronic ballasts.

Mounting and installation instructions can be obtained from Vossloh-Schwabe on request or can be found online at www.vossloh-schwabe.com.

1

2

3

4

5

6

7

8

9

10

Mechanical mounting

Surface	Solid, flat surface for good heat dissipation required. Avoid mounting on protruding surfaces.
Mounting location	Electronic ballasts must be protected against moisture and heat. Installation in external luminaires: water protection rate of ≥ 4 (e.g. IP54 required)
Fastening	With M4 screws in the designated holes
Heat transfer	If the ballast is destined for installation in a luminaire, sufficient heat transfer must be ensured between the ballast and the luminaire casing. Electronic ballasts should be mounted with the greatest possible clearance to heat sources or lamps. During operation, the temperature measured at the t_c point of the ballast must not exceed the specified maximum value.

Supplement for independent electronic ballasts

Mounting position	Any
Clearance	Min. of 0.10 m from walls, ceilings, insulation Min. of 0.10 m from other electronic ballasts Min. of 0.25 m from sources of heat (lamp)
Surface	Solid; device must not be allowed to sink into insulation materials

Technical specifications

Operating voltage range	AC: 220 to 240 V ($\pm 10\%$) DC: please observe the specifications on the individual product pages
Ignition time	ELXe ballasts $t < 0.5$ seconds (instant start)
Preheat time	ELXc and ELXd ballasts $t = 0.5$ or 1.5 to 2.5 seconds (warm start)
Leak current	≤ 0.5 mA per electronic ballast

Product features

Overheating VS EBs for fluorescent lamps are not protected against overheating

Overvoltage protection

- AC:** up to 48 hours at $U_{NAC} = 320$ V
- DC:** no disorders occur with input voltages of up to $U_{NDC} 285$ V.
 U_{NDC} voltages in excess of 288 V destroy the ballast.

Shutdown of defective lamps

During starting operation, the electronic ballast will detect whether a lamp is connected. If no lamp is present, the ballast will cancel the starting operation. Deactivated lamps or interrupted electrodes are detected and lead to the high-frequency supply being switched off after an unsuccessful ignition attempt. Changing a lamp during operation will lead to the high-frequency supply being switched off.

EOL effect Up to now, it has not been possible to conclusively reproduce the end-of-life effect under laboratory conditions. However, it can be qualitatively described for fluorescent lamps as follows: when the emitter material of the cathode (i.e. the filament in conventional bi-pin lamps) has been fully consumed or has otherwise lost its emitting power, the emission of electrons is hampered, which leads to a voltage drop at the cathode. Frequent cold starts accelerate active emitter loss.

Operating a lamp with a constant current (an electronic ballasts (EB) provides a near-constant current) results in high dissipation losses that also cause the lamp base and lampholder to heat up and can even cause damage to both. This is often referred to as the EOL effect; from an electrical point of view, this is manifested in the so-called "partial rectifier effect".

The EOL cut-out ensures that a ballast is safely switched off and the lamp base does not overheat at the end of a lamp's service life.

EN 61347-2-3:2011 + AC:2011 describes three possible tests.

The first are now in widespread use and are described in more detail here.

The third test is not conducted at VS.

1. EOL Test 1 (61347-2-3:2011 + AC:2011 17.2)
Asymmetric pulse test
2. EOL Test 2 (61347-2-3:2011 + AC:2011 17.3)
Asymmetric power test
3. EOL Test 3 (61347-2-3:2011 + AC:2011 17.4)
Exposed filament test

The first two tests attempt to simulate the rectifier effect:

- Test 1 pulse switching of rectifying effect
- Test 2 by applying a DC voltage that is constantly higher than required by the lamp.

VS EBs are capable of suitably assessing the altered voltage signal in comparison to normal operation so as to meet EOL requirements.

Protection against transient mains peaks

Values are in compliance with EN 61547 (interference immunity)
(1 kV for AC and 0.5 kV for DC and control conductors).

Electrical installation

Wiring

The wiring between the mains, electronic ballast and lamp must comply with the respective circuit diagram. Note: with ELXe models, one side of the lamp electrode is never connected to the electronic ballast.

The electronic ballast must be earthed using a toothed washer or similar (protection class I, ignition help, compliance with RFI/BCI standards).

To ensure compliance with RFI-suppression limits, mains conductors should not be wired in parallel to high-frequency carrying lamp conductors; maximum clearance should be ensured and all conductors marked with an * must be kept short. As a general rule, a maximum conductor length should not be exceeded when using conventional conductors (see table on page 221–223 for precise details). Luminaire must be tested for compliance with the RFI suppression limits stipulated by EN 55015.

Conductors must not exceed 3 m in length in the event of master-slave operation.

Dimmable electronic ballasts are unsuitable for master/slave operation.

1

2

3

4

5

6

7

8

9

10

Technical Details – Components for Fluorescent Lamps

Cord grip EBs with cord grip can be used with the following conductors, for instance:

Designation	Lead type
Mains lead	H03VV-F 3X0.75 mm ² or NYM 3X1.5 mm ²
Control lead	H03VV-F 2X0.5 mm ²
Mains and control lead in one lead	H03VV-F 5X0.75 mm ²
Lamp lead	H05VV-F 4X1 mm ² or 5X1 mm ²

Connection terminals for automatic luminaire wiring (ALF connections)

- Use copper (not stranded) wire
- Required diameter for push-in connection 0.5–1 mm²
- Stripped lead length 8–9 mm
- Required diameter for IDC 0.5 mm², max. Ø 2 mm including insulation, no wire stripping required; mounting requires a special tool

Push-in terminals The integrated terminals can be used with flexible or rigid leads with a crosssection of 0.5–1.5 mm². The stripped lead length ranges between 8.5–9.5 mm for a 3.5 mm terminal grid.

Error current Impulse-resistant leak-current protection must be installed. Distribute the luminaires to phases L1, L2 and L3; install tri-phase FI switches. If permissible, install FI switches with 30 mA leak current; connect no more than 15 luminaires as FI switches can be triggered at half the leak current value.

Tri-phase connection of luminaires with EB

- Prior to operating newly installed lighting systems: check the mains voltage is appropriate to the electronic ballast's mains voltage range (AC, DC).
- The N-type conductor must be properly connected to all luminaires or ballasts.
- Conductors can only be connected or disconnected if the ballast is disconnected from the mains. Attention: N-type conductors must never be disconnected individually or as the first element.
- Insulation resistance test: from L to PE (L and N must not be connected)
- The neutral conductor must be reconnected after completion of the test.

Power factor/compensation

Luminaires with electronic ballasts do not require compensation: power factor ≥ 0.95.

Selection of automatic cut-outs

Dimensioning automatic cut-outs

High transient currents occur when an EB is switched on because the capacitors have to load. Lamp ignition occurs almost simultaneously. This also causes a simultaneous high demand for power. These high currents when the system is switched on put a strain on the automatic conductor cut-outs, which must be selected and dimensioned to suit.

Release reaction The release reaction of the automatic conductor cut-outs comply with VDE 0641, part 11, for B and C characteristics.

No. of electronic ballasts (see the table on pages 229–231)

The maximum number of VS ballasts applies to cases where the devices are switched on simultaneously. Specifications apply to single-pole fuses. The number of permissible ballasts must be reduced by 20% for multi-pole fuses. The considered circuit impedance equals 400 mΩ (approx. 20 m of conductor [2.5 mm²] from the power supply to the distributor and a further 15 m to the luminaire). Doubling circuit impedance to 800 mΩ increases the possible number of ballasts by 10%.

EB output voltage Electronic ballasts bear the information "U_{OUT}" on their type plates. All subsequently connected components must be designed for this EB output voltage. When using T5 lamps, any components connected to the output side of the EB must be approved for a voltage of ≥ 430 V (especially lampholders). This also applies to dimmable T5 EBs.

Lamps and dimmed operation

For lighting systems with dimmable electronic ballasts, Vossloh-Schwabe recommends that fluorescent lamps always be replaced as a **full complement** to maintain uniform lighting levels and colour impressions. New lamps must be burnt in at maximum brightness for approx. 100 hours.

Without restrictions, VS electronic ballasts can be used to operate ECO T5 fluorescent lamps (except for with types ELXc 135.856 and ELXc 235.857) and T8 fluorescent lamps. A two-lamp dimmable electronic ballast can only be used with lamps of a single lamp manufacturer. The following EBs are restricted in their suitability for dimmer operation of amalgam lamps: ELXd 118.802, 218.803, 142.806, 242.807.

Dimming interface

DC 1–10 V according to EN 60929 with power source 0.5 mA (protected in the event of mains voltage connection); designed to enable connection of control and regulation units. Dimming range: 3–100% of lamp power

DAI (Digital Addressable Lighting Interface) dimming interface

Polarity reversible dimmer interface – protected in accordance with EN 60929 given mains voltage supply – for connecting control devices that work according to the standard digital protocol. Dimming range: 1–100% of the lamp's rating

Potential interference with IR systems

Operating lamps at frequencies of 20 to 50 kHz can cause interference with infrared systems (remote controls, sound transmission, personal pager systems).
Countermeasures: optical filters, switching to infrared systems with higher carrier frequencies (over 400 kHz).

1

2

3

4

5

6

7

8

9

10

Electromagnetic Compatibility (EMC)

Vossloh-Schwabe's electronic ballast range was developed in accordance with valid EMC standards (interference, interference immunity and mains harmonics) and specially designed to ensure safe compliance with the limiting values.

It is assumed that that any remarks regarding conductor wiring and conductor length in the instructions for installing electronic ballasts in luminaires or for independent ballasts will be observed.

Vossloh-Schwabe electronic ballasts are also tested in commercially available luminaires in addition to the CISPR 30 sample luminaires.

Mains harmonics: the maximum values laid down in EN 61547 (Interference Immunity) are satisfied.

Additional information

Information on the installation of electronic ballasts for optimising EMC

To ensure good radio interference suppression and the greatest possible operating safety, the following points should be observed when installing electronic ballasts:

- Conductors between the EB and the lamp (HF conductors) must be kept short (reduction of electromagnetic interference). High-potential lamp conductors must be kept as short as possible, in particular with tubular lamps. Lamp conductors of this kind are labelled with an * in the wiring diagram on the type plate (see page 221–223).
- Mains and lamp conductors must be kept separate and if possible should not be laid in parallel to one another. The distance between HF and mains conductors should be as large as possible, ideally > 5 cm. (This prevents the induction of interference between the mains and lamp conductors.)
- The mains conductor within the luminaire must be kept short (to reduce the induction of interference).
- Devices must be properly earthed. EBs require secure contacts to the luminaire casing or must be earthed using a PE connection. This PE connection should be effected using an independent conductor to achieve better dissipation of the leak current. EMC improves at frequencies greater than 30 MHz.
- The mains conductor must not be laid too close to the EB or the lamp (this is especially important in the event of through-wiring).
- Mains and lamp conductors must not be crossed. Should this be impossible to avoid, conductors should be crossed at right angles to one another to avoid inducing interference between mains and HF conductors.
- Should conductors be wired through metal parts, such conductors must always be additionally shielded (e.g. with an insulating sleeve or grommet).

Temperature

Reference point temperature t_c

The safe operation of electronic ballasts is dependent on the maximum permissible temperature not being exceeded at the measuring point. Vossloh-Schwabe has determined a casing temperature measuring point – $t_{c \text{ max.}}$ – on all EB casings. To avoid shortening the service life or diminishing operating safety, the stipulated maximum temperature must not be exceeded at this t_c point. This point is determined by testing the converter during normal, IEC-standardised operation at the specified ambient temperature (t_a), which is also indicated on the type plate. As both the design-related ambient temperature and the ballast's inherent heat, as determined by the installed load, are subject to great variation, the casing temperature should be tested at the t_c point under real installation conditions.

Ambient temperature t_a

The ambient temperature – as specified on every EB – denotes the permissible temperature range within the luminaire.

Reliability and service life

If the max. temperature at the t_c reference point (as specified on the type plate and the technical documentation of the ballast) is not exceeded, the defined service life can be expected to be achieved, assuming a switching cycle of 165 minutes on and 15 minutes off. See page 211 for service life details regarding the various electronic ballast families.

Emergency lighting

All Vossloh-Schwabe EBs that are suitable for DC voltage operation can be used in emergency lighting systems. Consideration must, however, be taken of system requirements.

VS Dimmable Electronic Ballasts

Vossloh-Schwabe's range of electronic ballasts is rounded off by dimmable ballasts for fluorescent lamps. The standardised interfaces "1-10 V" and "DALI" are used for this purpose. Coupled with sensors, electronic ballasts fitted with a "1-10 V" interface make it easy to create intelligent luminaires and room lighting systems, whereby the luminaires are "programmed" via the wiring to the control units, i.e. via the hardware.

The digital interface "DALI" (Digital Addressable Lighting Interface) constitutes a further development of the "1-10 V" analogue interface. This digital interface was jointly developed by leading manufacturers of electronic ballasts in order to create a uniform standard for the lighting industry. The uniform interface and telegram definition dictates the function of a DALI operating device or DALI consumer and ensures exchangeability of operating devices made by various manufacturers.

Each VS DALI ballast is additionally fitted with the so-called PUSH function. The data input DA (DALI & PUSH) is used as a control input for both signal structures, with the exception of devices featuring separate inputs. When used as a DALI ballast, control is effected via the DALI protocol; when used as a PUSH ballast, control is effected via a push key and is achieved via current flow times of differing duration.

Due to the working principle involved, dimming compact fluorescent lamps causes a negligible drop in colour temperature. However, sudden larger changes in the dimmer setting can temporarily cause greater variation in colour temperature. The dimmer function is optimised to minimise this subjective visual change in colour temperature when the dimmer setting is suddenly subjected to larger change.

VS DALI electronic ballasts are characterised by the following performance feature

- Two-strand, potential-free, polarity-independent control input
- Dimmer curve analogue to the light sensitivity of the human eye
- Addressing options: total system, group-wise or individually
- Scene memory
- Feedback in the event of defective lamps

These features ensure a number of advantages for lighting systems

- No group wiring needed
- Each DALI ballast can be individually addressed
- No need for scene memory modules
- Synchronised scene transitions
- Operating devices provide reports on lamp status
- Simple integration into facility management systems



VS DALI electronic ballasts provide the convenience of a bus system that is both easy to install and operate.

DALI and PUSH must not be used at the same time!

Switching mains voltage to the DALI conductors within a DALI system will lead to the destruction of both the DALI power supply and the DALI master!

1

2

3

4

5

6

7

8

9

10

PUSH function characteristic

- Just one key for dimming and ON/OFF
- Polarity- and phase-independent control
- Control input with large working voltage range
- Suitable for multi-layer control
- Fully DC-compatible – no functional restrictions during DC operation
- After disconnection from the primary voltage the ballast will reproduce the last stored lighting level
- Soft start
- Automatic recognition of DALI and PUSH signals

PUSH operating voltage ranges during control signal input

EB type	ELXd 118.705, ELXd 218.707, ELXd 142.709, ELXd 242.711	All other DALI/PUSH ballasts
AC	220–240 V ±10%	10–230 V
DC	198–264 V	–
Failing to observe these working voltage ranges can lead to non-recognition of the signals; exceeding the maximum voltages can lead to the destruction of the data inputs.		

PUSH control signals (key activation)

Short push	(80 ms < t < 460 ms)	(0 ms < t < 500 ms)
	Is used to switch between ON/OFF lighting states. After the device is switched on, the last selected lighting level is restored and the next dimming direction will be upwards.	
Long push	(460 ms < t < 10 s)	(500 ms < t < ∞)
	Is used to dim upwards or downwards; a long push will change the dimming direction. Thus, a long push will reverse the dimming direction until the upper or lower limit is reached. If the light was off, a long push will switch it on and the dimmer will start at the lowest light intensity.	
Push to synchronise	(t > 10 s)	long – short – long
	Light is dimmed to the preset factory level and the next dimming direction will be upwards.	Starting situation: luminaires are switched off. The "long – short – long" combination first switches the lamp on, then off and finally on again, after which it gets gradually brighter. The EBs will be synchronised again after this procedure.
Synchronisation	Any 1-key dimmer that does not feature a central control module (as each ballast will have its own controls) can develop asynchronous behaviour (e.g. children might play with the key). The system will then be out of sync, i.e. some lamps will be on, others off or the dimming direction will differ from lamp to lamp.	
	Two methods of synchronisation can be used: <ul style="list-style-type: none"> • Push the key for more than 10 seconds, after which the light will be dimmed to a preset level and the next dimming direction will be upwards. • Start with a long push of the key so that all lamps are switched on. Follow with a short push to turn the system off. The system will now be resynchronised. 	

Wiring examples for PUSH function

Note **Not permissible:** N-type conductors must not be used as PUSH potentials for multi-phase systems. Example: if the PUSH key is not activated, the series connection of the internal resistors of the DA inputs will approach the delta voltage of 400 V (voltage between L2 and L3) (Fig. 1).

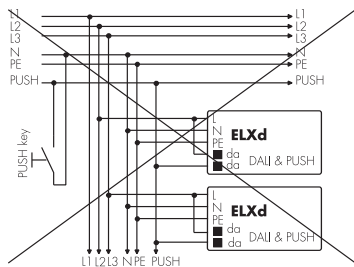

Fig. 1
N conductor must not be used as a PUSH potential

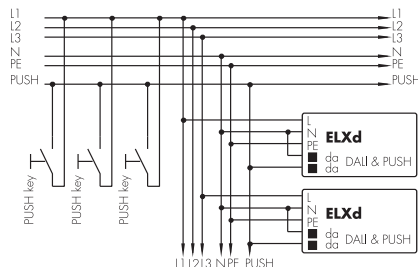

Fig. 2
Standard application for T5 and T8 lamps

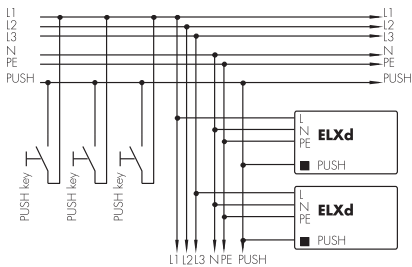

Fig. 3
Standard application for TC lamps

General information on PUSH and DALI

Mains voltage and interface conductors must not be wired in parallel to the lamp conductors so as to avoid capacitive bridging of the mains filter.

If more than one device is operated with a single key during PUSH operation, asynchronous behaviour can occur, which will require manual resynchronisation using the method described. Should this be unacceptable, a DALI control module will have to be used instead. It is recommended not to control more than four devices using a single key.

When using dimmable devices, new lamps should generally be burnt in for at least 100 hours at full brightness before they are dimmed. This process can become necessary again should the lamps be physically relocated (e.g. transport).

After initial operation of a DALI system (address assignment, luminaire allocation, group formation, scene settings) it is recommended to disconnect the primary voltage of the DALI control units at the circuit breaker for at least 3 seconds and then to reconnect it. The devices will detect this disconnection from the mains and store the settings.

DALI devices with a PUSH function must be operated with a control module (DALI control module or key pad with PUSH function). DALI devices with a PUSH function must not be operated with an open or bridged DALI/PUSH input.

To ensure the ballast does not distort and misinterpret signals when operated in PUSH mode, connected PUSH buttons must not feature a control lamp.

1

2

3

4

5

6

7

8

9

10

Circuit diagrams for Vossloh-Schwabe electronic ballasts

The circuit diagrams shown here are wiring examples for Vossloh-Schwabe electronic ballasts, whereby the number and configuration of the contacts differ. See the table on page 221–223 for details.

EB	1 lamp	2 lamps	3 lamps	4 lamps
ELXd				
ELXc				

* ELXc devices can also be wired under observation of the circuit diagram on the ballast.

Explanation of circuit diagrams for Vossloh-Schwabe electronic ballasts (see page 220)

Electronic ballasts Ref. No.	Lamp Type	Quantity	Electronic ballasts Terminals															Max. lead length hot* cold	Operation frequency	Output voltage U _{OUT} V	THD %	Possible quantity of EB/automatic cut-outs				
			1	2	3	4	5	6	7	8	9	10	11	12	13	14	15					(m/pf)	(m/pf)	kHz	V	%
ELXc																										
183039	ELXc 424.223	3	x*	x*	-	x	x	x	x	x	-	-	x	x	-	-	-	1/100	2/200	44	400	< 10	9	14	14	22
		4	x*	x*	-	x	x	x	x	x	x	-	-	x	x	-	-	-	1/100	2/200	44	400	< 10	9	14	14
183040	ELXc 226.878	1	x	x	-	-	x*	x*	-	-	-	-	-	-	-	-	-	1/100	1.5/150	45	300	< 10	11	18	18	30
		2	x	x	x	x	x*	x*	-	-	-	-	-	-	-	-	-	1/100	1.5/150	45	300	< 10	11	18	18	30
183108	ELXc 226.878	1	x	x	-	-	x*	x*	-	-	-	-	-	-	-	-	-	1/100	1.5/150	45	300	< 10	11	18	18	30
		2	x	x	x	x	x*	x*	-	-	-	-	-	-	-	-	-	1/100	1.5/150	45	300	< 10	11	18	18	30
183109	ELXc 414.227	3	x*	x*	x	x	x	x	x	x	x	x	x*	x*	-	-	-	1/100	2/200	45	350	< 15	7	12	12	20
		4	x*	x*	x	x	x	x	x	x	x	x	x*	x*	-	-	-	1/100	2/200	45	350	< 15	7	12	12	20
183110	ELXc 424.228	3	x*	x*	x	x	x	x	x	x	x	x	x*	x*	-	-	-	1/100	2/200	47	350	< 15	7	12	12	20
		4	x*	x*	x	x	x	x	x	x	x	x	x*	x*	-	-	-	1/100	2/200	47	350	< 15	7	12	12	20
183111	ELXc 228.229	1	x*	x*	x	x	x	x	-	-	-	-	-	-	-	-	-	1/100	2/200	47	350	< 15	9	15	15	25
		2	x*	x*	x	x	x	x	-	-	-	-	-	-	-	-	-	1/100	2/200	47	350	< 20	9	15	15	25
183112	ELXc 328.230	2	x*	x*	x	x	x	x	x	x	x	x*	x*	-	-	-	-	1/100	2/200	45	350	< 15	7	12	12	20
		3	x*	x*	x	x	x	x	x	x	x	x*	x*	-	-	-	-	1/100	2/200	45	350	< 15	7	12	12	20
183113	ELXc 135.231	1	x*	x*	x	x	-	-	-	-	-	-	-	-	-	-	-	1/100	2/200	47	400	< 15	11	18	18	30
183114	ELXc 235.232	2	x	x	x*	x*	x*	x*	-	-	-	-	-	-	-	-	-	1/100	2/200	46	400	< 15	9	15	15	25
183115	ELXc 239.233	1	x*	x*	x	x	x	x	-	-	-	-	-	-	-	-	-	1/100	2/200	47	350	< 15	7	12	12	20
		2	x*	x*	x	x	x	x	-	-	-	-	-	-	-	-	-	1/100	2/200	47	350	< 15	7	12	12	20
183116	ELXc 149.234	1	x*	x*	x	x	-	-	-	-	-	-	-	-	-	-	-	1/100	2/200	47	250	< 15	9	15	15	25
183117	ELXc 249.235	2	x	x	x*	x*	x*	x*	-	-	-	-	-	-	-	-	-	1/100	2/200	47	350	< 15	7	12	12	20
183118	ELXc 254.236	1	x*	x*	x	x	x	x	-	-	-	-	-	-	-	-	-	1/100	2/200	48	350	< 15	7	12	12	20
		2	x*	x*	x	x	x	x	-	-	-	-	-	-	-	-	-	1/100	2/200	48	350	< 15	7	12	12	20
183119	ELXc 180.237	1	x*	x*	x	x	-	-	-	-	-	-	-	-	-	-	-	1/100	2/200	46	350	< 15	9	15	15	25
183122	ELXc 114.238	1	x*	x*	x	x	-	-	-	-	-	-	-	-	-	-	-	1/100	2/200	45	380	< 20	8	17	17	28
183123	ELXc 128.239	1	x*	x*	x	x	-	-	-	-	-	-	-	-	-	-	-	1/100	2/200	45	380	< 20	8	17	17	28
183124	ELXc 214.240	2	x	x	x	x	x*	x*	x*	-	-	-	-	-	-	-	-	1/100	2/200	45	380	< 20	8	17	17	28
183125	ELXc 228.241	2	x	x	x	x	x*	x*	x*	-	-	-	-	-	-	-	-	1/100	2/200	45	380	< 20	4	7	7	12
183126	ELXc 414.242	4	x*	x*	x	x	x	x	x	x	x*	x*	-	-	-	-	-	1/100	2/200	45	430	< 20	4	7	7	12
183127	ELXc 118.243	1	x*	x*	x	x	-	-	-	-	-	-	-	-	-	-	-	1/100	2/200	45	390	< 20	8	17	17	28
183128	ELXc 136.244	1	x*	x*	x	x	-	-	-	-	-	-	-	-	-	-	-	1/100	2/200	45	390	< 20	8	17	17	28
183129	ELXc 158.245	1	x*	x*	x	x	-	-	-	-	-	-	-	-	-	-	-	1/100	2/200	45	390	< 20	4	7	7	12
183130	ELXc 218.246	2	x*	x*	x	x	x	-	-	-	-	-	-	-	-	-	-	1/100	2/200	45	390	< 20	8	17	17	28
183131	ELXc 236.247	2	x*	x*	x	x	x	-	-	-	-	-	-	-	-	-	-	1/100	2/200	45	390	< 20	4	7	7	12
183132	ELXc 258.248	2	x*	x*	x	x	x*	x*	x	-	-	-	-	-	-	-	-	1/100	2/200	45	390	< 20	2	5	5	8
183133	ELXc 418.249	4	x*	x*	x	x	x	x	x	x	x*	x*	-	-	-	-	-	1/100	2/200	45	390	< 20	4	7	7	12
183134	ELXc 118.879	1	x*	x*	x	x	-	-	-	-	-	-	-	-	-	-	-	1/100	2/200	45	380	< 20	8	17	17	28
183135	ELXc 126.880	1	x*	x*	x	x	-	-	-	-	-	-	-	-	-	-	-	1/100	2/200	45	380	< 20	8	17	17	28
183136	ELXc 218.881	2	x*	x*	x	x	x*	x*	-	-	-	-	-	-	-	-	-	1/100	2/200	45	380	< 20	4	7	7	12
183137	ELXc 226.882	2	x*	x*	x	x	x*	x*	-	-	-	-	-	-	-	-	-	1/100	2/200	45	380	< 20	4	7	7	12
188093	ELXc 135.856	1	x*	x*	x	x	-	-	-	-	-	-	-	-	-	-	-	1/100	2/200	44	330	< 10	11	18	18	30
188094	ELXc 235.857	2	x*	x*	x	x	x	x*	x*	-	-	-	-	-	-	-	-	1/100	2/200	45	330	< 10	9	15	15	25
188095	ELXc 149.858	1	x*	x*	x	x	-	-	-	-	-	-	-	-	-	-	-	1/100	2/200	28	330	< 10	11	18	18	30
188140	ELXc 140.862	1	x*	x*	x	x	-	-	-	-	-	-	-	-	-	-	-	1/100	2/200	45	250	< 10	11	18	18	30
188142	ELXc 154.864	1	x*	x*	x	x	-	-	-	-	-	-	-	-	-	-	-	1/100	2/200	34	300	< 10	9	15	15	25
188144	ELXc 180.866	1	x*	x*	x	x	-	-	-	-	-	-	-	-	-	-	-	1/100	2/200	45	300	< 10	9	15	15	25
188438	ELXc 414.868	3	x*	x*	-	x	x	x	x	-	-	x	x	-	-	-	-	1/100	2/200	45	400	< 10	7	12	12	20
		4	x*	x*	-	x	x	x	x	x	x	x	x	-	-	-	-	1/100	2/200	45	400	< 10	7	12	12	20
188589	ELXc 128.869	1	x*	x*	x	x	-	-	-	-	-	-	-	-	-	-	-	1/100	1.5/150	54	450	< 10	11	18	18	30
188590	ELXc 128.869	1	x*	x*	x	x	-	-	-	-	-	-	-	-	-	-	-	1/100	1.5/150	54	450	< 10	11	18	18	30
188595	ELXc 336.214	3	x	x	x	x	x	x	x*	x*	-	-	-	-	-	-	-	1/100	2/200	70	370	< 10	6	11	11	18
188616	ELXc 240.863	2	x*	x*	x	-	x	x	-	-	-	-	-	-	-	-	-	1/100	2/200	46	360	< 15	7	12	12	20
188617	ELXc 249.859	2	x*	x*	x	x	x	x*	x*	-	-	-	-	-	-	-	-	1/100	2/200	43	480	< 10	7	12	12	20
188618	ELXc 254.865	2	x*	x*	x	-	x	x	x	-	-	-	-	-	-	-	-	1/100	2/200	43	390	< 10	7	12	12	20
188619	ELXc 280.538	2	x*	x*	x	x	x	x*	x*	-	-	-	-	-	-	-	-	1/100	2/200	50	420	< 10	-	10	-	10
188643	ELXc 242.837	2	x	x	x	x	x*	x*	-	-	-	-	-	-	-	-	-	1/100	1.5/150	43	440	< 15	7	12	12	20
188680	ELXc 155.378	1	x	x	x*	x*	-	-	-	-	-	-	-	-	-	-	-	1/100	1.5/150	47	250	< 15	7	12	12	20
188681	ELXc 155.378	1	x	x	x*	x*	-	-	-	-	-	-	-	-	-	-	-	1/100	1.5/150	47	250	< 15	7	12	12	20

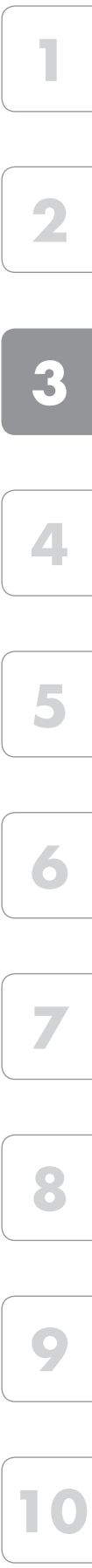

Technical Details – Components for Fluorescent Lamps

Electronic ballasts		Lamp	Electronic ballasts													Max. lead length		Operation	Output	THD	Possible quantity of EB/automatic cut-outs						
Ref. No.	Type	Quantity	Terminals													hot*	cold	frequency	voltage	%	EB/automatic cut-outs						
			1	2	3	4	5	6	7	8	9	10	11	12	13	14	15	(m/pt)	(m/pt)	kHz	U _{OUT}		B	B	C	C	
																					V		(10A)	(16A)	(10A)	(16A)	
ELXc																											
188698	ELXc 213.870	1	x	x	—	—	x*	x*	—	—	—	—	—	—	—	—	—	1/100	1.5/150	42	250	< 20	11	18	18	30	
		2	x	x	x	x	x*	x*	—	—	—	—	—	—	—	—	—	1/100	1.5/150	42	250	< 20	11	18	18	30	
188699	ELXc 218.871	1	x	x	—	—	x*	x*	—	—	—	—	—	—	—	—	—	1/100	1.5/150	35	350	< 12	11	18	18	30	
		2	x	x	x	x	x*	x*	—	—	—	—	—	—	—	—	—	1/100	1.5/150	35	350	< 12	11	18	18	30	
188700	ELXc 142.872	1	x	x	—	—	x*	x*	—	—	—	—	—	—	—	—	—	1/100	1.5/150	44	480	< 15	11	18	18	30	
		2	x	x	x	x	x*	x*	—	—	—	—	—	—	—	—	—	1/100	1.5/150	44	480	< 15	11	18	18	30	
188704	ELXc 136.207	1	x	x	—	—	x*	x*	—	—	—	—	—	—	—	—	—	—	—	48	350	< 20	11	18	18	30	
188705	ELXc 236.208	2	x	x	x	x	x*	x*	—	—	—	—	—	—	—	—	—	—	—	45	250	< 20	11	18	18	30	
188706	ELXc 158.209	1	x	x	—	—	x*	x*	—	—	—	—	—	—	—	—	—	—	—	33	250	< 20	9	15	15	25	
188707	ELXc 258.210	2	x	x	x	x	x*	x*	—	—	—	—	—	—	—	—	—	—	—	48	350	< 20	7	12	12	19	
188712	ELXc 213.870	1	x	x	—	—	x*	x*	—	—	—	—	—	—	—	—	—	1/100	1.5/150	42	250	< 20	11	18	18	30	
		2	x	x	x	x	x*	x*	—	—	—	—	—	—	—	—	—	1/100	1.5/150	42	250	< 20	11	18	18	30	
188713	ELXc 218.871	1	x	x	—	—	x*	x*	—	—	—	—	—	—	—	—	—	1/100	1.5/150	35	350	< 12	11	18	18	30	
		2	x	x	x	x	x*	x*	—	—	—	—	—	—	—	—	—	1/100	1.5/150	35	350	< 12	11	18	18	30	
188714	ELXc 142.872	1	x	x	—	—	x*	x*	—	—	—	—	—	—	—	—	—	1/100	1.5/150	44	480	< 15	11	18	18	30	
		2	x	x	x	x	x*	x*	—	—	—	—	—	—	—	—	—	1/100	1.5/150	44	480	< 15	11	18	18	30	
188744	ELXc 418.204	3	x*	x*	—	x	x	x	x	—	x	x	—	—	—	—	—	1/100	2/200	44	480	< 10	7	12	12	20	
		4	x*	x*	—	x	x	x	x	x	x	x	—	—	—	—	—	1/100	2/200	44	480	< 10	7	12	12	20	
188912	ELXc 136.216	1	x	x	—	—	x*	x*	—	—	—	—	—	—	—	—	—	1/75	1.5/100	47,5	430	< 20	17	28	28	46	
188913	ELXc 236.217	2	x*	x*	x	x	x*	x*	—	—	—	—	—	—	—	—	—	1/75	1.5/100	45	430	< 10	17	28	28	46	
188914	ELXc 158.218	1	x	x	—	—	x*	x*	—	—	—	—	—	—	—	—	—	1/75	1.5/100	34	430	< 10	17	28	28	46	
188915	ELXc 258.219	2	x*	x*	x	x	x*	x*	—	—	—	—	—	—	—	—	—	1/75	1.5/100	52	430	< 10	17	28	28	46	
188921	ELXc 135.220	1	x*	x*	x	x	—	—	—	—	—	—	—	—	—	—	—	1/100	2/150	41	300	< 10	11	18	18	30	
188922	ELXc 235.221	2	x	x	x	x	x	x*	x*	—	—	—	—	—	—	—	—	1/100	2/150	41	300	< 10	11	18	18	30	
ELXd																											
183059	ELXd 235.735	2	x*	x*	x	x	x	x*	x*	—	—	—	—	—	—	—	—	1/100	2/200	42	300	< 5	10	17	18	28	
188329	ELXd 124.600	1	x	x	—	—	x*	x*	—	—	—	—	—	—	—	—	—	1/100	1.5/150	76–120	430	< 10	17	28	28	46	
188330	ELXd 224.601	2	x	x	x	x*	x*	x*	x*	—	—	—	—	—	—	—	—	1/100	1.5/150	53–120	430	< 10	17	28	28	46	
188331	ELXd 139.602	1	x	x	—	—	x*	x*	—	—	—	—	—	—	—	—	—	1/100	1.5/150	85–120	430	< 10	17	28	28	46	
188332	ELXd 154.603	1	x	x	—	—	x*	x*	—	—	—	—	—	—	—	—	—	1/100	1.5/150	83–120	430	< 10	17	28	28	46	
188333	ELXd 254.604	2	x	x	x	x*	x*	x*	x*	—	—	—	—	—	—	—	—	1/100	1.5/150	44–120	430	< 10	8	13	13	21	
188334	ELXd 180.605	1	x	x	—	—	x*	x*	—	—	—	—	—	—	—	—	—	1/100	1.5/150	91–120	430	< 10	12	19	19	31	
188335	ELXd 249.606	2	x	x	x	x*	x*	x*	x*	—	—	—	—	—	—	—	—	1/100	1.5/150	44–120	430	< 10	8	13	13	21	
188336	ELXd 124.607	1	x	x	—	—	x*	x*	—	—	—	—	—	—	—	—	—	1/100	1.5/150	76–120	430	< 10	17	28	28	46	
188337	ELXd 224.608	2	x	x	x	x*	x*	x*	x*	—	—	—	—	—	—	—	—	1/100	1.5/150	53–120	430	< 10	17	28	28	46	
188338	ELXd 139.609	1	x	x	—	—	x*	x*	—	—	—	—	—	—	—	—	—	1/100	1.5/150	85–120	430	< 10	17	28	28	46	
188339	ELXd 239.610	2	x	x	x	x*	x*	x*	x*	—	—	—	—	—	—	—	—	1/100	1.5/150	53–120	430	< 10	17	28	28	46	
188340	ELXd 154.611	1	x	x	—	—	x*	x*	—	—	—	—	—	—	—	—	—	1/100	1.5/150	83–120	430	< 10	17	28	28	46	
188341	ELXd 254.612	2	x	x	x	x*	x*	x*	x*	—	—	—	—	—	—	—	—	1/100	1.5/150	44–120	430	< 10	8	13	13	21	
188342	ELXd 180.613	1	x	x	—	—	x*	x*	—	—	—	—	—	—	—	—	—	1/100	1.5/150	91–120	430	< 10	12	19	19	31	
188343	ELXd 249.614	2	x	x	x	x*	x*	x*	x*	—	—	—	—	—	—	—	—	1/100	1.5/150	44–120	430	< 10	8	13	13	21	
188350	ELXd 239.621	2	x	x	x	x*	x*	x*	x*	—	—	—	—	—	—	—	—	1/100	1.5/150	53–120	430	< 10	17	28	28	46	
188431	ELXd 226.801	2	x	x	x	x	x*	x*	—	—	—	—	—	—	—	—	—	0.5/50	0.75/75	50–90	470	< 10	7	12	12	20	
188490	ELXd 226.801	2	x	x	x	x	x*	x*	—	—	—	—	—	—	—	—	—	0.5/50	0.75/75	50–90	470	< 10	7	12	12	20	
188549	ELXd 218.803	2	x*	x*	x	x	x	x*	x*	—	—	—	—	—	—	—	—	0.5/50	0.75/75	60–99	300	< 10	11	18	18	30	
188550	ELXd 242.807	2	x*	x*	x	x	x	x*	x*	—	—	—	—	—	—	—	—	0.5/50	0.75/75	45–95	400	< 10	7	12	12	20	
188564	ELXd 118.802	1	x	x	—	—	x*	x*	—	—	—	—	—	—	—	—	—	0.5/50	0.75/75	60–105	400	< 10	11	18	18	30	
188565	ELXd 142.806	1	x	x	—	—	x*	x*	—	—	—	—	—	—	—	—	—	0.5/50	0.75/75	40–95	400	< 10	11	18	18	30	
188597	ELXd 324.623	3	—	x*	x*	x*	x*	x*	x*	—	—	—	x*	x*	x*	x*	—	0.5/50	—	67–120	430	< 10	8	13	13	21	
188598	ELXd 424.624	4	—	x*	x*	x*	x*	x*	x*	x*	—	—	x*	x*	x*	x*	—	0.5/50	—	45–120	430	< 10	8	13	13	21	
188600	ELXd 324.626	3	—	x*	x*	x*	x*	x*	x*	—	—	—	x*	x*	x*	x*	—	0.5/50	—	67–120	430	< 10	8	13	13	21	
188602	ELXd 424.628	4	—	x*	x*	x*	x*	x*	x*	x*	—	—	x*	x*	x*	x*	—	0.5/50	—	45–120	430	< 10	8	13	13	21	
188604	ELXd 280.630	2	x	x	x	x*	x*	x*	x*	—	—	—	—	—	—	—	—	1/100	1.5/150	44–120	430	< 10	5	9	9	15	
188605	ELXd 280.631	2	x	x	x	x*	x*	x*	x*	—	—	—	—	—	—	—	—	1/100	1.5/150	44–120	430	< 10	5	9	9	15	
188694	ELXd 118.802	1	x	x	—	—	x*	x*	—	—	—	—	—	—	—	—	—	0.5/50	0.75/75	60–105	400	< 10	11	18	18	30	
188695	ELXd 142.806	1	x	x	—	—	x*	x*	—	—	—	—	—	—	—	—	—	0.5/50	0.75/75	40–95	400	< 10	11	18	18	30	
188696	ELXd 218.803	2	x*	x*	x	x	x	x*	x*	—	—	—	—	—	—	—	—	0.5/50	0.75/75	60–99	300	< 10	11	18	18	3	

Electronic ballasts		Lamp	Electronic ballasts													Max. lead length	Operation	Output	THD	Possible quantity of EB/automatic cut-outs							
Ref. No.	Type	Quantity	Terminals													hot*	cold	frequency	U _{OUT}	%	B		C				
			1	2	3	4	5	6	7	8	9	10	11	12	13	14	15	(m/pt)	(m/pt)	kHz	V		(10A)	(16A)	(10A)	(16A)	
ELXd																											
188873	ELXd 118.718	1	x*	x*	x	x	—	—	—	—	—	—	—	—	—	—	—	1.5/150	2,0/200	55–113	300	< 5	15	24	25	40	
188874	ELXd 218.719	2	x*	x*	x	x	x	x*	x*	—	—	—	—	—	—	—	—	1.5/150	2,0/200	42–114	400	< 5	17	27	28	46	
188875	ELXd 136.720	1	x*	x*	x	x	—	—	—	—	—	—	—	—	—	—	—	1.5/100	2,0/200	47–105	300	< 5	15	24	25	40	
188876	ELXd 236.721	2	x*	x*	x	x	x	x*	x*	—	—	—	—	—	—	—	—	1.5/100	2,0/200	42–107	400	< 5	17	27	27	44	
188877	ELXd 158.722	1	x*	x*	x	x	—	—	—	—	—	—	—	—	—	—	—	1.5/100	2,0/200	47–105	300	< 8	15	24	25	40	
188878	ELXd 258.723	2	x*	x*	x	x	x	x*	x*	—	—	—	—	—	—	—	—	1.5/150	2,0/200	45–110	400	< 10	11	18	19	31	
188923	ELXd 142.709	1	—	—	x*	x*	x*	x*	—	—	—	—	—	—	—	—	—	0.5/50	0.5/50	41–104	400	< 10	8	12	12	20	
188924	ELXd 142.709	1	—	—	x*	x*	x*	x*	—	—	—	—	—	—	—	—	—	0.5/50	0.5/50	41–104	400	< 10	8	12	12	20	
188932	ELXd 135.724	1	x*	x*	x	x	—	—	—	—	—	—	—	—	—	—	—	1/100	2/200	43	330	< 10	11	17	18	29	
188933	ELXd 235.725	2	x*	x*	x	x	x	x*	x*	—	—	—	—	—	—	—	—	1/100	2/200	43	330	< 5	10	17	18	28	
188953	ELXd 118.705	1	—	—	x*	x*	x*	x*	—	—	—	—	—	—	—	—	—	0.5/50	0.5/50	47	250	< 10	13	20	21	34	
188954	ELXd 218.707	2	x*	x*	x*	x*	x*	x*	x*	—	—	—	—	—	—	—	—	0.5/50	0.5/50	41	250	< 10	12	20	21	33	
188955	ELXd 218.707	2	x*	x*	x*	x*	x*	x*	x*	—	—	—	—	—	—	—	—	0.5/50	0.5/50	41	250	< 10	12	20	21	33	
188974	ELXd 242.711	2	x*	x*	x*	x*	x*	x*	x*	—	—	—	—	—	—	—	—	0.5/50	0.5/50	40	250	< 10	12	20	21	33	
188975	ELXd 242.711	2	x*	x*	x	x*	x*	x*	—	—	—	—	—	—	—	—	—	0.5/50	0.5/50	40	250	< 10	12	20	21	33	

Electromagnetic ballasts

Electromagnetic (inductive) ballasts are active components that in conjunction with starters preheat the lamp electrodes, supply the ignition voltage and stabilise lamp currents during operation. Series or parallel capacitors are required to compensate blind current.

For installation in luminaires, consideration must be taken of the mains voltage and mains frequency, the dimensions and maximum thermal values as well as any potential noise generation. To fulfil these special requirements, Vossloh-Schwabe provides a large variety of different ballasts.

VS magnetic ballasts have been optimised with regard to their magnetic fields and loads so that usually so that noise cannot usually be perceived. However, the luminaire design can cause magnetic vibrations to affect large areas. When designing luminaires, it might therefore be necessary to fit a concertina section or grooves to prevent vibrations from spreading and thus from noise being generated.

The service life of an inductive ballast is mainly determined by the material chosen for the winding insulation. The maximum winding temperature denotes the temperature (tw) that the insulation will withstand for a period of 10 years given continuous operation under rated conditions. This maximum winding temperature must not be exceeded in real conditions to ensure the ballast can achieve its full service life. The winding temperature of the ballast that is measured in the luminaire is made up of the ambient temperature of the luminaire, the thermal conditions within the luminaire and the power loss of the ballast. The Δt marking on the ballast type plate provides a measure of the power loss of the ballast. In addition to this, the power loss of ballast-lamp circuits is measured in accordance with EN 50294. This test method forms the basis for the CELMA energy classification of ballasts and is also applied in European Regulation 245/2009/EG "Definition of eco-design requirements regarding fluorescent lamps without an integrated ballast, high-pressure discharge lamps as well as ballasts and luminaires in their operation and the invalidation of Directive 2000/55/EC" (see pages 233–235 for further details).

As a result of their design features, inductive ballasts cause leak current that is discharged via the earth conductor of the luminaire. The maximum permissible leak current for protection class I luminaires is 1 mA, a value of which all Vossloh-Schwabe electronic ballasts fall clearly short. Values of max. 0.1 mA are measured per electromagnetic ballast. However, as these values accumulate with the number of installed ballasts, this should be taken into account when dimensioning the F1 protective switch.

Starters for fluorescent lamps

As mentioned above, the operation of fluorescent lamps also requires starters in addition to ballasts. A distinction is made between glow starters, which are also available with automatic cut-outs, and electronic starters. The correct choice of voltage and power range is crucial. Starters are available for 220–240 V and for 110–127 V mains voltage. The latter are also required for twin-lamp operation (e.g. 2x18 W at 230 V).

Operating SL-series VS ballasts (100–127 V) depends on the use of a 220–240 V starter as these operating devices are high-reactance transformers that supply higher voltages to the lamp. Starters should only be used with starter contacts with a hardness value of at least HB 100.

Assembly Instructions for Electromagnetic Ballasts

For mounting and installing of electromagnetic ballasts for fluorescent lamps

Mandatory regulations

DIN VDE 0100	Erection of low voltage installations
EN 60598-1	Luminaires – part 1: general requirements and tests
EN 61347-1	Operating devices for lamps – part 1: general and safety requirements
EN 61347-2-8	Operating devices for lamps – part 2-8: special requirements for ballasts for fluorescent lamps
EN 60921	Ballasts for fluorescent tube lamps – performance requirements
EN 50294	Methods for measuring the total input power of ballast-lamp circuits
EN 55015	Maximum values and methods of measurement for RFI suppression in electrical lighting installations and similar electrical appliances
EN 61000-3-2	Electromagnetic Compatibility (EMC) – part 3: maximum values – main section part 2: maximum values for mains harmonics (device input current up to and including 16 A per conductor)
EN 61547	Installations for general lighting purposes – EMC immunity requirements

Technical specifications

Operating voltage range	VS ballasts can be operated at the specified mains voltage within a tolerance range of $\pm 10\%$
Leak current	≤ 0.1 mA per ballast
Error current	Impulse-resistant leak-current protection must be installed. Distribute the luminaires to phases L1, L2 and L3; install tri-phase FI switches. If permissible, install FI switches with 30 mA leak current; connect no more than 15 luminaires as FI switches can be triggered at half the leak current value.
Power factor	Inductive ballasts: $\lambda \geq 0.5$ Parallel-compensated ballasts: $\lambda \geq 0.85$

Compensation VS recommends the use of parallel capacitors owing to their technical advantages and power balance.

Possible interference with IR systems
Are not known to occur

Mechanical mounting

Mounting position
Any

Mounting location
Ballasts are designed for installation in luminaires or comparable devices.
Independent ballasts do not need to be installed in a casing.

Fastening Preferably using screws \varnothing 4 mm

Maximum temperatures
The stipulated winding temperature (tw 130, tw 140 and tw 150, respectively) must not be exceeded during normal operation. The corresponding maximum values (232 °C, 248 °C and 264 °C, respectively) must be observed during anomalous operation. These values must be checked by measuring resistance during operation.

Temperature increase
The lamp current flowing through the ballast generates a power loss that leads to an increase in winding temperature. The Δt values for normal and abnormal operation provide a measure of this temperature increase. The Δt values are ascertained using standardised connections for measurement and are provided on the ballast type plate in Kelvin.

Example: $\Delta t = 55 \text{ K}/140 \text{ K}$:

The first Δt value indicates the temperature increase for normal operation at the lamp's operating current. The second value, 140 K in this case, denotes the temperature increase of the winding that results from the current that flows when the lamp's discharge path is short-circuited. The current that flows in this state is the preheat current through the lamp's electrodes.

Electromagnetic compatibility (EMC)

Interference Interference voltage measurements have to be taken at the connection terminals for luminaires with magnetic ballasts as these are systems that operate with lamp voltages of under 100 Hz. These low-frequency interference voltages are generally not critical with magnetic ballasts.

Interference immunity
Thanks to the robust design and choice of materials, magnetic ballasts provide a high degree of interference immunity and are not impaired by admissible mains power interference.

Mains Harmonics
After every zero crossing of the lamp current, fluorescent lamps experience a re-ignition peak as the lamps go out for a brief (imperceptible) moment. These re-ignition peaks generate mains harmonics that are smoothed by the ballast's impedance. The right design, i.e. determining the operating point of the magnetic ballast, ensures mains harmonics are limited to the maximum values permitted by EN 61000-3-2. VS electromagnetic ballasts all comply with the stipulated maximum values.

1

2

3

4

5

6

7

8

9

10

Selection of automatic cut-outs for VS electromagnetic ballasts

Dimensioning automatic cut-outs

When a ballast is switched on, high transient current peaks occur due to parasite capacitances that can accumulate with the number of luminaires. These high system switch-on currents put a strain on the automatic conductor cut-outs. For this reason, only surge-current-proof automatic cut-outs should be used for lighting systems.

Release reaction The release reaction of the automatic conductor cut-outs comply with VDE 0641, part 11, for B and C characteristics.

No. of ballasts The following values are meant as guidelines only and may vary depending on the respective lighting system. The maximum number of VS ballasts applies to cases where the devices are switched on simultaneously. Specifications apply to single-pole fuses. The number of permissible ballasts must be reduced by 20% for multi-pole fuses. The considered circuit impedance equals 400 mΩ (approx. 20 m of [2.5 m²] conductor from the power supply to the distributor and a further 15 m to the luminaire). Doubling circuit impedance to 800 mΩ increases the possible number of ballasts by 10%. The values quoted in the following tables are guidelines and can be affected by systemspecific factors.

Possible number of ballasts connected to automatic cut-outs for compact fluorescent lamps (single lamp operation)

Lamp output W	10 A (B)		16 A (B)	
	Inductive	Parallel compensation	Inductive	Parallel compensation
5/7/8/9/10/11/13	50	90	80	130
18 (TC-L)	27	32	43	51
18 (TC-D)	40	65	65	110
24	25	32	40	51
26	27	32	43	51
36	23	32	37	51

Possible number of ballasts connected to automatic cut-outs for tubular and U-shaped fluorescent lamps (single lamp operation)

Lamp output W	10 A (B)		16 A (B)	
	Inductive	Parallel compensation	Inductive	Parallel compensation
4/6/8/10	50	90	80	130
13	45	80	70	115
15/18/20	27	32	43	51
30/36/38/40	23	32	37	51
58/65	15	20	22	32
70	13	18	20	30

Reliability and service life

Provided the specified maximum values for the winding temperature are complied with, a service life of 10 years can be expected. Failure rate: $\leq 0.025\%/1,000$ hours.

Electrical installation

Connection terminals (combination terminals)

- Use copper (not stranded) wire
- Required diameter for push-in connection 0.5–1 mm²
- Stripped lead length 8 mm
- Required cross-section for IDC zone 0.5 mm²; max. \varnothing 2 mm including insulation, no wire stripping required; mounting requires a special tool

Push-in terminals The integrated terminals can only be used with rigid leads.
Rigid leads: 0.5–1.5 mm². The stripped lead length totals 8 mm.

Wiring The wiring between the mains, ballasts and lamps must comply with the respective circuit diagram.

Circuit diagrams for the operation of fluorescent lamps with Vossloh-Schwabe electromagnetic ballasts

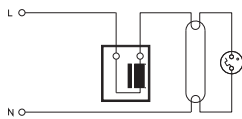

Inductive single circuit

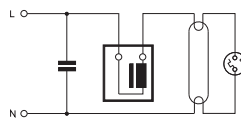

Parallel-compensated single circuit

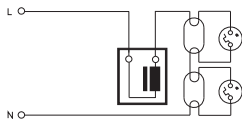

Inductive tandem circuit

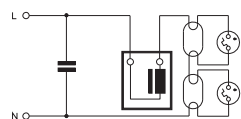

Parallel-compensated tandem circuit

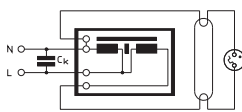

Parallel-compensated single circuit with high-reactance transformer

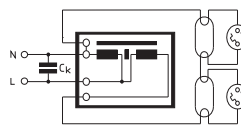

Parallel-compensated tandem circuit with high-reactance transformer

1

2

3

4

5

6

7

8

9

10

Connection terminals

In the interest of ensuring firm contacts and long component service life, Vossloh-Schwabe uses only top-quality materials for plastic or metal parts during the production of connection terminals. These quality features apply to both Vossloh-Schwabe's luminaire connection terminals as well as to the terminals fitted to ballasts and lampholders.

Notes on connection terminals on electronic ballasts

Vossloh-Schwabe electronic ballasts are fitted with installation-friendly push-in connectors. In addition, many models for linear fluorescent lamps are also available with IDC terminals (for solid conductors 0.5 mm²) and supplementary push-in terminals (for solid conductors 0.5–1 mm²), stripped length 8–9 mm. IDC terminals permit automated luminaire wiring and testing using the ALF system and are thus particularly efficient.

Notes on connection terminals on electromagnetic ballasts

Standard issue Vossloh-Schwabe electromagnetic ballasts are fitted with installation-friendly IDC/push-in terminals (combination terminals) or push-in terminals. The terminals are designed for use with solid conductors with cross-sections of 0.5–1 mm² (combination terminals) or up to 1.5 mm² (push-in terminals) and are approved for current loads of up to 6 A (combination terminal) and 16 A (push-in terminal). The lead stripping length totals 7–9 mm for push-in terminals; leads do not need to be stripped for IDC terminals. On request, many ballasts can also be provided with screw terminals (current load up to 16 A) for conductor cross-sections of 0.5 to 2.5 mm².

Notes on connection terminals on lampholders

Vossloh-Schwabe usually equips lampholders for T and TC lamps as well as starter lampholders with installation-friendly push-in terminals for solid conductors of 0.5–1 mm². Most lampholders are fitted with twin push-in terminals and thus permit through-wiring. The required lead stripping length amounts to 8–9 mm for all types.

IDC terminals

In order to fully exploit the vast potential for rationalisation offered by automated wiring and testing with the ALF system, a totally new component family was developed that is equipped with the VDE-tested IDC terminal technology. This technology has already been used very successfully on a large scale in other branches of industry. This connection technology dispenses with the stripping of conductors that is required for the push-in, screw or crimping methods. The tried-and-tested IDC terminal technology has created the foundation for efficient automation as it ensures both high connection quality and rapid contacting. Components equipped in this fashion make it possible to through-wire several terminals with a single conductor. This constitutes a further economic advantage as it significantly reduces the required conductor lengths. Furthermore, this design principle makes it possible to use adapters to simply and reliably make electrical contact from above for a VDE-compatible final luminaire inspection.

ALF connection

Height: 12 mm

Release by twisting and pulling the conductor at the same time

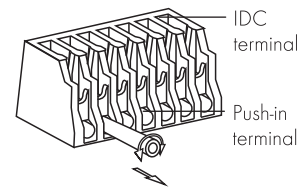

1. Insert release tool above the conductor
2. Pull out the conductor

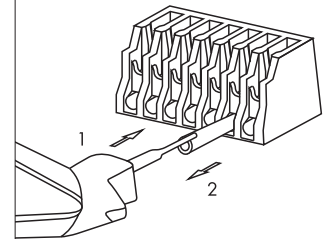

Stripping the conductor for push-in terminal 0.5–1 mm²: 8–9 mm

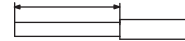

IDC/Push-in terminal for electromagnetic ballasts

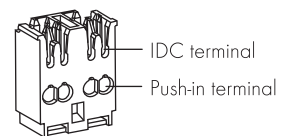

Stripping the conductor for push-in terminal 0.5–1 mm²: 7–9 mm

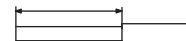

Lampholders for Fluorescent Lamps

Lampholders for compact fluorescent lamps

Vossloh-Schwabe produces the majority of lampholders for TC lamps using PBT, a thermoplastic material. This highly heat-resistant material is responsible for the T140 temperature rating. Leading lamp manufacturers also use PBT for the lamp bases they produce. This material harmonisation in conjunction with fatigue-free, stainless steel lamp mounting springs ensures a permanently secure lamp fit.

Lampholders for double-ended fluorescent lamps

VS lampholders for T lamps are characterised by a number of technical features that guarantee a high degree of reliability and safety. The heat-resistant PBT rotor with which most VS lampholders are fitted is a recognised trademark. In addition to the lampholders with the field-tested large rotor, VS also provides a new generation of lampholders featuring innovative "Rotoclic" rotor technology. This new VS technology constitutes a further milestone in the development of highly heat-resistant rotor systems.

Among the special features of this new technology is a T140 temperature rating thanks to a front plate made entirely of PBT as well as a clearly audible click when the lamp is inserted or replaced. As a result, the motion of turning the lamp from "replacement" to "operating" position is aided acoustically.

In addition to this, VS produces a further series of lampholders with a rotor-like function, whose front plates are also made of highly heat-resistant PBT and have similarly been given a T140 temperature rating.

The maximum permissible temperature at the back of all lampholders is T_m 110 °C. Another key feature common to all VS lampholders is a highly effective support for the lamp pin that reliably prevents any base pin deflection, even with older lamps, and guarantees a durable and firm contact.

Push-through lampholders

Push-through lampholders are inserted from below through a cut-out in the luminaire casing and are secured by lateral catches. This type of lampholder is frequently used in luminaires on which the lampholder remains visible from the outside, e.g. in so-called strip lighting. The electrical leads are laid beneath the sheet metal level. Luminaire directive EN 60598-1 Para. 8.2 must be observed with regard to the luminaire.

Push-fit lampholders

This lampholder type, which is frequently found in surface-mounted ceiling and built-in luminaires, is pushed into the luminaire casing from above. The lampholder foot should protrude by no more than 4 mm to match the usual height of the spacing cams in the luminaire casing. These lampholders are mostly wired above the luminaire casing to the side of the lampholder. However, there are also lampholders on which the wiring runs through the lampholder foot, with the leads laid beneath the luminaire casing.

Built-in lampholders

This design is also predominantly used for recessed ceiling and surface-mounted luminaires. However, unlike push-fit lampholders, built-in lampholders are usually fitted at the ends of the luminaire boxes. In addition to the usual fixing with split pins attached to the rear, there are also countless versions with fixing clips, push-fit studs or screw-in holes, which are also available with spring-loaded length compensation. Built-in lampholders offer luminaire designers a wealth of scope regarding the choice of lamp position in relation to the reflector. This enables great variation in light distribution as the lampholder does not dictate the distance of the centre of the lamp from the metal casing.







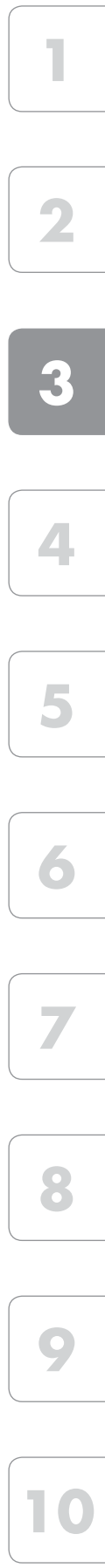
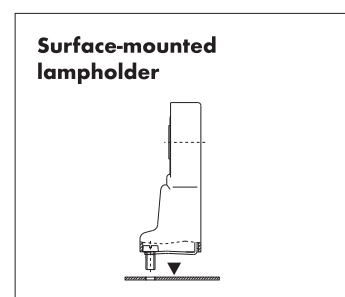
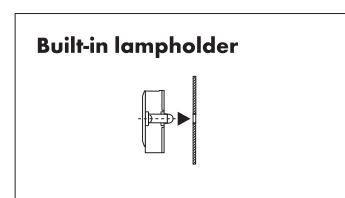
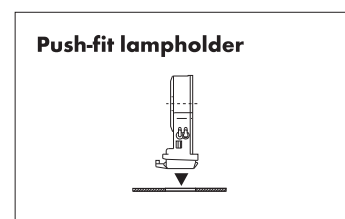
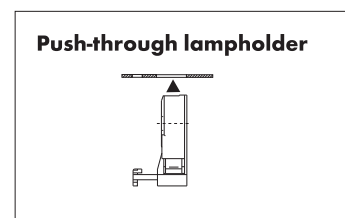
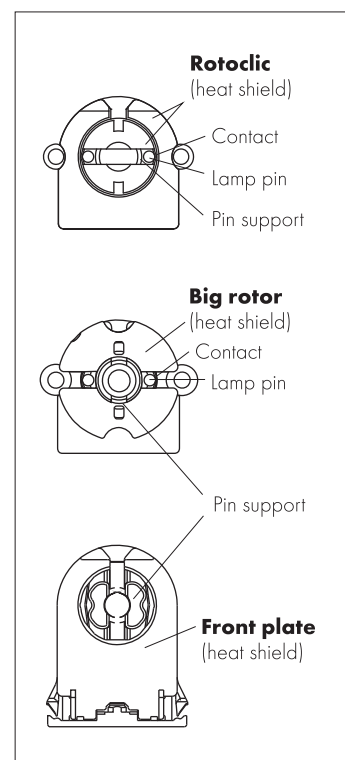



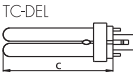



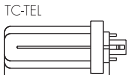





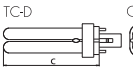



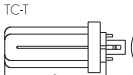



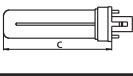

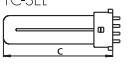



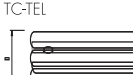

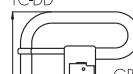
Surface-mounted lampholders

The fastening system of surface-mounted lampholders usually consists of screws or rivets above a fixing level, along which the wiring is also laid. As this type of installation is usually too costly nowadays for large unit numbers, these lampholders are used almost exclusively for special applications, e.g. displays or illuminated advertisements.

VS lampholders for the UL market and UL approved leads are available for all common lamp types. Further information can be found at www.unvlt.com.

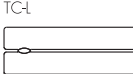

Lamp Table – Fluorescent Lamps

Lamp type/lamp base	Base	Output (W)	Max. length (C) acc. to IEC					
TC-DEL  G24q-1  -2  -3 	G24q-1	10 13	95 130					
	G24q-2	18	140					
	G24q-3	26	160					
TC-TEL  GX24q-1  -2  -3  -4  -5  -6 	GX24q-1	13	90					
	GX24q-2	18	110					
	GX24q-3	26	130					
		32	145					
	GX24q-4	42	155					
	GX24q-5	57	191					
GX24q-6	70	219						
TC-D  G24d-1  -2  -3 	G24d-1	8 10 13	73* 95 130					
		G24d-2	18	140				
		G24d-3	26	160				
TC-T  GX24d-1  -2  -3 	GX24d-1	13	90					
	GX24d-2	18	110					
	GX24d-3	26	130					
TC-S  G23 	G23	5 7 9 11	85 115 145 215					
TC-SEL  2G7 		5 7 9 11	85 115 145 215					
		TC-TEL  2G8-1 	60 85 120	167 208 285				
			TC-TEL  GR14q-1 	14 17	A	B	C	D
	GR14q-1			14 17	99.7 121.7	120 142	126.6 148.6	41* 41*
TC-DD  GR8  GR10q  GRY10q-3  GRZ10d  GRZ10t 	GR8	16 28	138 205					
		GR10q	10 16 21 28 38	92 138 141 205 207				
			GRY10q-3	55	205 205*			
			GRZ10d	18	137 141*			
			GRZ10t	30	202 206*			
			TC-F  2G10 	2G10	18 24 36	122 165 217		
TC-L  2G11 	2G11	18 24 34 36 40 55 80			225 320 533* 415 535 535 565			

*not included in IEC standard (non-committal specifications)

Lamp Table – Fluorescent Lamps

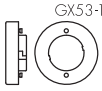
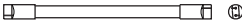
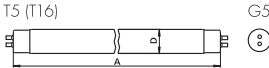
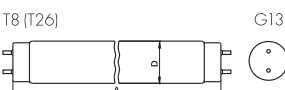
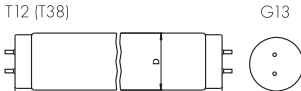
Lamp type/lamp base	Base	Output (W)	Ø D (mm)	Length A/C (mm) acc. to IEC 60081/ 60901 (for circular lamps B)
	GX53-1	7 9		
	W4.3x8.5d	6 8 11 13	7 7 7 7	219.3 320.9 422.5 524.1
	G5	4 6 8 13 14 20 21 24 25 28 32 34 35 39 45 49 50 54 73 80	16 16	135.9 212.1 288.3 516.9 549.0 549.0 849.0 549.0 1149.0 1149.0 1449.0 849.0 1449.0 849.0 1449.0 1449.0 1449.0 1449.0 1149.0 1449.0 1449.0
	G13	10 14 15 16 16 18 20*1 23 30 32 33 34 36 36 38 50 51 58 70	26 26	470.0*2 360.0*2 437.4 589.8 720.0*2 589.8 438.0*2 970.0*2 894.6 1199.4 1149.0 1047.0*2 1199.4 970.0*2 1047.0 1500.0 1500.0 1500.0 1763.8
	G13	20 25 30 40 65 75 80*1 85 85*1 100 100*1 115 125 140 140*1 160*1	38 38 38 38 38 38 38 38 38 38 38 38 38 38 38 38 38 38	589.8 970.0 894.6 1199.4 1500.0 1763.8 1500.0 2374.3 1763.8 2374.3 1800.0*2 1200.0*2 2374.3 1500.0*2 1800.0*2 1800.0*2

*1 UV solarium lamps

*2 Not included in IEC standard
(non-committal specifications)

- 1
- 2
- 3
- 4
- 5
- 6
- 7
- 8
- 9
- 10

Lamp Table – Fluorescent Lamps

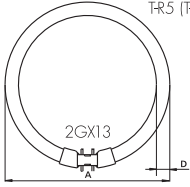
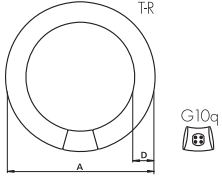
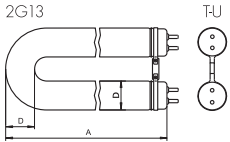
Lamp type/lamp base	Base	Output (W)	Ø D (mm)	A (mm)
 <p>TR5 (TR16) 2GX13</p>	2GX13	22 40 55 60	16 16 16 16	230.0 305.0 305.0 379.0
 <p>TR G10q</p>	G10q	22 32 40 60	29 29 29 30	215.9 304.8 406.4 408.8*
 <p>2G13 TU</p>	2G13-92	18 36 58	26 26 26	304* 566, 601* 566, 759*

* Not yet included in IEC standard (non-committal specifications)

Tube lengths of plastic and glass protective tube

Ø D (mm)	Length L (mm)
38±0.5	L = A-20±1
50±0.8	L = A-30±1

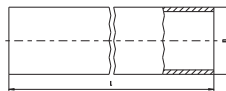

Key to lamp designations

TC-S	Tube CompactSingle
TC-SEL	Tube CompactSingle Electronic
TC-D	Tube CompactDouble
TC-DEL	Tube CompactDouble Electronic
TC-T	Tube CompactTriple
TC-TEL	Tube CompactTriple Electronic
TC-Q	Tube CompactQuad
TC-QEL	Tube CompactQuad Electronic
TC-DD	Tube CompactDouble D-Shape
TC-L	Tube CompactLong
TC-F	Tube CompactFlat
T2 (T7)	Tube Ø 2/8" (7 mm)
T5 (T16)	Tube Ø 5/8" (16 mm)
T8 (T26)	Tube Ø 8/8" (26 mm)
T12 (T38)	Tube Ø 12/8" (38 mm)
T-U	Tube, U-Shape
T-R	Tube, Ring-Shape
T-R5 (T-R16)	Tube, Ring-Shape Ø 5/8" (16 mm)

Energy efficiency classification

Together with the amendments in Commission Regulation (EU) 2015/1428 dated 25. August 2015, Commission Regulation (EU) 245/2009 dated 18. March 2009 implementing Directive 2005/32/EC of the European Parliament and of the Council with regard to defining ecodesign requirements for fluorescent lamps without integrated ballast, high-pressure discharge lamps and for ballasts and luminaires needed for their operation, and repealing Directive 2000/55/EC of the European Parliament and of the Council (official title), has created a legal framework in the EU that defines fundamental requirements for operating efficient lighting technology products.

Although the Regulation predominantly applies to general lighting, it is also product-orientated and thus independent of any specific application. The efficiency and performance requirements (specifications governing performance features) apply to fluorescent lamps without integrated ballast, high-pressure discharge lamps as well as ballasts and luminaires needed to operate these lamps.

1

2

3

4

5

6

7

8

9

10

Energy efficiency classification

The following table taken from Regulation 245/2009/EC provides an overview of (1st- and 2nd-stage) ballast requirements, ordered according to efficiency values:

Lamp data					Ballast efficiency (P _{lamp} /P _{input})				
Type	Nominal output W	ILCOS-Code	Typical rating		(non-dimmable ballasts)				
			50 Hz W	HF W	A2 BAT %	A2 %	A3 %	B1 %	B2 %
T8	15	FD-15-E-G13-26/450	15	13.5	87.8	84.4	75.0	67.9	62.0
	18	FD-18-E-G13-26/600	18	16	87.7	84.2	76.2	71.3	65.8
	30	FD-30-E-G13-26/900	30	24	82.1	77.4	72.7	79.2	75.0
	36	FD-36-E-G13-26/1200	36	32	91.4	88.9	84.2	83.4	79.5
	38	FD-38-E-G13-26/1050	38.5	32	87.7	84.2	80.0	84.1	80.4
	58	FD-58-E-G13-26/1500	58	50	93.0	90.9	84.7	86.1	82.2
	70	FD-70-E-G13-26/1800	69.5	60	90.9	88.2	83.3	86.3	83.1
TC-L	18	FSD-18-E-2G11	18	16	87.7	84.2	76.2	71.3	65.8
	24	FSD-24-E-2G11	24	22	90.7	88.0	81.5	76.0	71.3
	36	FSD-36-E-2G11	36	32	91.4	88.9	84.2	83.4	79.5
TC-F	18	FSS-18-E-2G10	18	16	87.7	84.2	76.2	71.3	65.8
	24	FSS-24-E-2G10	24	22	90.7	88.0	81.5	76.0	71.3
	36	FSS-36-E-2G10	36	32	91.4	88.9	84.2	83.4	79.5
TC-D/	10	FSQ-10-E-G24q=1 FSQ-10+G24d=1	10	9.5	89.4	86.4	73.1	67.9	59.4
TC-DE	13	FSQ-13-E-G24q=1 FSQ-13+G24d=1	13	12.5	91.7	89.3	78.1	72.6	65.0
	18	FSQ-18-E-G24q=2 FSQ-18+G24d=2	18	16.5	89.8	86.8	78.6	71.3	65.8
	26	FSQ-26-E-G24q=3 FSQ-26+G24d=3	26	24	91.4	88.9	82.8	77.2	72.6
TC-T/	13	FSM-13-E-GX24q=1 FSM-13+GX24d=1	13	12.5	91.7	89.3	78.1	72.6	65.0
TC-TE	18	FSM-18-E-GX24q=2 FSM-18+GX24d=2	18	16.5	89.8	86.8	78.6	71.3	65.8
	26	FSM-26-E-GX24q=3 FSM-26+GX24d=3	26.5	24	91.4	88.9	82.8	77.5	73.0
TC-DD/	10	FSS-10-E-GR10q FSS-10L/P/H-GR10q	10.5	9.5	86.4	82.6	70.4	68.8	60.5
TC-DDE	16	FSS-16-E-GR10q FSS-16+GR10q FSS-10L/P/H-GR10q	16	15	87.0	83.3	75.0	72.4	66.1
	21	FSS-21-E-GR10q FSS-21+GR10q FSS-21-L/P/H-GR10q	21	19	89.4	86.4	79.2	73.9	68.8
	28	FSS-28-E-GR10q FSS-28+GR10q FSS-28-L/P/L-GR10q	28	26	89.7	86.7	81.3	78.2	73.9
	38	FSS-38-E-GR10q FSS-38-L/P/L-GR10q	38.5	36	92.3	90.0	85.7	84.1	80.4
TC	5	FSD-5+G23 FSD-5-E-2G7	5.4	5	72.7	66.7	58.8	49.3	41.4
	7	FSD-7+G23 FSD-7-E-2G7	7.1	6.5	77.6	72.2	65.0	55.7	47.8
	9	FSD-9+G23 FSD-9-E-2G7	8.7	8	78.0	72.7	66.7	60.3	52.6
	11	FSD-11+G23 FSD-11-E-2G7	11.8	11	83.0	78.6	73.3	66.7	59.6
T5	4	FD-4-E-G5-16/150	4.5	3.6	64.9	58.1	50.0	45.0	37.2
	6	FD-6-E-G5-16/225	6	5.4	71.3	65.1	58.1	51.8	43.8
	8	FD-8-E-G5-16/300	7.1	7.5	69.9	63.6	58.6	48.9	42.7
	13	FD-13-E-G5-16/525	13	12.8	84.2	80.0	75.3	72.6	65.0
T9-C	22	FSC-22-E-G10q-29/200	22	19	89.4	86.4	79.2	74.6	69.7
	32	FSC-32-E-G10q-29/300	32	30	88.9	85.7	81.1	80.0	76.0
	40	FSC-40-E-G10q-29/400	40	32	89.5	86.5	82.1	82.6	79.2

Lamp types

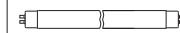

T8

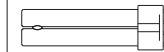

TC-L

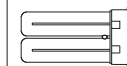

TC-F

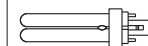

TC-D/TC-DE

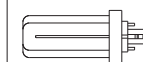

TC-T/TC-TE

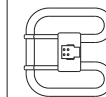

TC-DD/TC-DDE

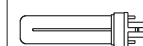

TC



T5

Technical Details – Components for Fluorescent Lamps

Lamp data				Ballast efficiency ($P_{\text{lamp}}/P_{\text{input}}$) (non-dimmable ballasts)					
Type	Nominal output W	ILCOS-Code	Typical rating						
			50 Hz W	HF W	A2 BAT %	A2 %	A3 %	B1 %	B2 %
T2	6	FDH-6L/P-W4.3x8.5d7/220		5	72.7	66.7	58.8	—	—
	8	FDH-8L/P-W4.3x8.5d7/320		7.8	76.5	70.9	65.0	—	—
	11	FDH-11L/P-W4.3x8.5d7/420		10.8	81.8	77.1	72.0	—	—
	13	FDH-13L/P-W4.3x8.5d7/520		13.3	84.7	80.6	76.0	—	—
	21	FDH-21L/P-W4.3x8.5d7		21	88.9	85.7	79.2	—	—
	23	FDH-23L/P-W4.3x8.5d7		23	89.8	86.8	80.7	—	—
T5-E	14	FDH-14L/P-G5-16/550		13.7	84.7	80.6	72.1	—	—
	21	FDH-21L/P-G5-16/850		20.7	89.3	86.3	79.6	—	—
	24	FDH-24L/P-G5-16/550		22.5	89.6	86.5	80.4	—	—
	28	FDH-28L/P-G5-16/1150		27.8	89.8	86.9	81.8	—	—
	35	FDH-35L/P-G5-16/1450		34.7	91.5	89.0	82.6	—	—
	39	FDH-39L/P-G5-16/850		38	91.0	88.4	82.6	—	—
	49	FDH-49L/P-G5-16/1450		49.3	91.6	89.2	84.6	—	—
	54	FDH-54L/P-G5-16/1150		53.8	92.0	89.7	85.4	—	—
	80	FDH-80L/P-G5-16/1150		80	93.0	90.9	87.0	—	—
	95	FDH-95L/P-G5-16/1150		95	92.7	90.5	84.1	—	—
	120	FDH-120L/P-G5-16/1450		120	92.5	90.2	84.5	—	—
T5-C	22	FSCH-22L/P-2GX13-16/225		22.3	88.1	84.8	78.8	—	—
	40	FSCH-40L/P-2GX13-16/300		39.9	91.4	88.9	83.3	—	—
	55	FSCH-55L/P-2GX13-16/300		55	92.4	90.2	84.6	—	—
	60	FSCH-60L/P-2GX13-16/375		60	93.0	90.9	85.7	—	—
TC-IE	40	FSDH-40L/P-2G11		40	91.4	88.9	83.3	—	—
	55	FSDH-55L/P-2G11		55	92.4	90.2	84.6	—	—
	80	FSDH-80L/P-2G11		80	93.0	90.9	87.0	—	—
TC-TE	32	FSMH-32L/P-GX24q=3		32	91.4	88.9	82.1	—	—
	42	FSMH-42L/P-GX24q=4		43	93.5	91.5	86.0	—	—
	57	FSM6H-57L/P-GX24q=5 FSM8H-57L/P-GX24q=5		56	91.4	88.9	83.6	—	—
	70	FSM6H-70L/P-GX24q=6 FSM8H-70L/P-GX24q=6		70	93.0	90.9	85.4	—	—
	60	FSM6H-60L/P-2G8=1		63	92.3	90.0	84.0	—	—
	62	FSM8H-62L/P-2G8=2		62	92.2	89.9	83.8	—	—
	82	FSM8H-82L/P-2G8=2		82	92.4	90.1	83.7	—	—
	85	FSM6H-85L/P-2G8=1		87	92.8	90.6	84.5	—	—
	120	FSM6H-120L/P-2G8=1 FSM8H-120L/P-2G8=1		122	92.6	90.4	84.7	—	—
	TC-DD	55	FSSH-55L/P-GR10q		55	92.4	90.2	84.6	—

At the very latest, the following energy efficiency formula for ballasts will be introduced to coincide with the 3rd stage:

$$\begin{aligned} \text{If } P_{\text{lamp}} \leq 5 \text{ W} & \quad E_{\text{BbFL}} = 0.71 \\ \text{If } 5 \text{ W} < P_{\text{lamp}} < 100 \text{ W} & \quad E_{\text{BbFL}} = P_{\text{lamp}} / (2 \cdot \sqrt{P_{\text{lamp}}/36} + 38/36 \cdot P_{\text{lamp}} + 1) \\ \text{If } P_{\text{lamp}} \geq 100 \text{ W} & \quad E_{\text{BbFL}} = 0.91 \end{aligned}$$

The following limiting values must be observed:

η_{Ballast}	Energy efficiency classes
$\geq E_{\text{BbFL}}$	A2 and A1 BAT
$\geq 1 - 0.75 \cdot (1 - E_{\text{BbFL}})$	A2 BAT

The graph illustrates the difference between Classes A2, A1 BAT and A2 BAT (BAT = best available technology).

Lamp types

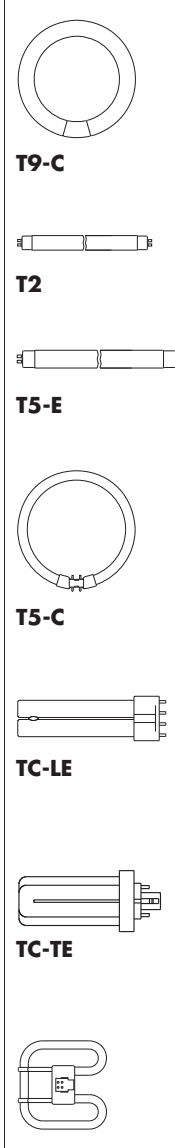

The diagrams show the following lamp types:

- T9-C**: Compact fluorescent lamp with a circular shape and a small base.
- T2**: Standard fluorescent lamp with a long, thin tube.
- T5-E**: Extra long fluorescent lamp with a long, thin tube.
- T5-C**: Compact fluorescent lamp with a circular shape and a larger base.
- TC-LE**: Linear fluorescent lamp with a long, thin tube and a single end connector.
- TC-TE**: Twin end fluorescent lamp with a long, thin tube and two end connectors.
- TC-DD**: Double end fluorescent lamp with a long, thin tube and two end connectors.

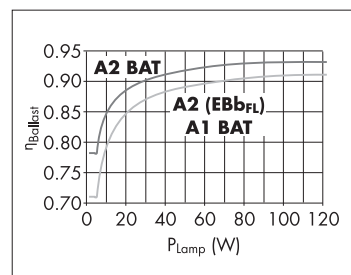

SYSTEM- OPTIMISING COMPENSATION



PARALLEL CAPACITORS

Capacitors are designed to compensate inductive reactive current of discharge lamps in 50/60 Hz networks when operated with electromagnetic ballasts. As required by utility companies, capacitors serve to compensate the reactive current generated by the respective ballast. A power factor of $\lambda \geq 0.9$ is achieved.

In addition, capacitors can also be used to compensate or generate phase displacements. Careful selection of the raw materials as well as special thermal treatment of the capacitor coil guarantee a long service life and stable capacitance.



4

Parallel Capacitors

Parallel capacitors

238–241

Technical details for parallel capacitors

242–251

General technical details

348–356

Glossary

357–359

1

2

3

4

5

6

7

8

9

10

Parallel Connected Capacitors with Break-action Mechanism

Capacitors type B

Casing: aluminium

Filling material: based on vegetable oil

Fastening: male nipple with nut and washer included

Discharge resistance

Overpressure protection

On request further capacities or connectors



A Push-in twin terminals 0.5–1 mm²

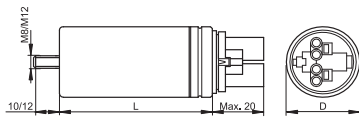

B Double spade connector 6.3x0.8 acc. to IEC 61210

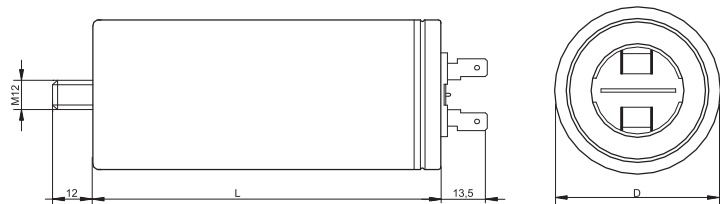

Parallel Connected Capacitors with Break-action Mechanism

Capacitors type B

Ref. No.	Capacity µF	Temperature range °C	Drawing	Ø (D) mm	Length (L) mm	Male nipple/ length (mm)	Weight g	Unit pcs.
250 V, 50/60 Hz								
536378	2.0	-40 to 100	A	25	63	M8x10	85	100
536379	4.0	-40 to 100	A	25	63	M8x10	80	100
536380	6.0	-40 to 100	A	25	63	M8x10	80	100
536381	8.0	-40 to 100	A	25	63	M8x10	85	100
551645	9.0	-40 to 100	A	30	78	M8x10	95	100
536382	10.0	-40 to 100	A	30	78	M8x10	90	100
536383	12.0	-40 to 100	A	30	78	M8x10	90	100
536384	13.0	-40 to 100	A	30	78	M8x10	90	100
536385	16.0	-40 to 100	A	35	78	M8x10	90	81
536386	18.0	-40 to 100	A	35	78	M8x10	90	81
536387	20.0	-40 to 100	A	35	78	M8x10	90	81
536388	25.0	-40 to 100	A	40	78	M8x10	100	64
536389	30.0	-40 to 100	A	35	103	M8x10	100	81
536390	32.0	-40 to 100	A	35	103	M8x10	120	81
536391	35.0	-40 to 100	A	40	103	M8x10	120	64
536392	40.0	-40 to 100	A	40	103	M8x10	120	64
536393	45.0	-40 to 100	A	40	103	M8x10	150	64
536394	50.0	-40 to 100	A	45	103	M8x10	150	49
536395	55.0	-40 to 100	A	45	103	M8x10	150	49
536396	60.0	-40 to 100	A	45	103	M8x10	200	49
380-450 V, 50/60 Hz								
536397	13.0	-40 to 85	A	35	103	M8x10	100	81
536398	18.0	-40 to 85	A	40	103	M8x10	120	64
536399	28.0	-40 to 85	A	45	103	M8x10	150	49
536400	32.0	-40 to 85	A	45	103	M8x10	200	49
536401	37.0	-40 to 85	A	50	103	M12x12	200	36
536402	50.0	-40 to 85	A	55	103	M12x12	250	36
536403	55.0	-40 to 85	B	50	128	M12x12	250	36
536404	60.0	-40 to 85	B	55	128	M12x12	250	36
536405	85.0	-40 to 85	B	60	138	M12x12	300	36

1

2

3

4

5

6

7

8

9

10

Parallel Connected Capacitors 250 V, 50/60 Hz

Capacitors type A

Casing: plastics, white or aluminium

Fastening: male nipple

with nut and washer included

Discharge resistance

Optional: thermal cut-out,

European wide patent

On request with alternative capacities, connection terminals, mounting options, casing materials or with a thermal fuse as well as versions with IDC terminal for the automatic luminaire wiring

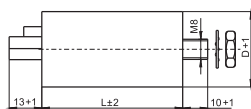

Ref. No.	Capacity µF	Temperature range °C	Ø (D) mm	Length (L) mm	Male nipple/ length (mm)	Push-in twin terminals	Weight g	Unit pcs.
Plastic casing								
500296	2.0	-40 to 85	30	53	M8x10	0.5-1 mm ²	22	530
500299	2.5	-40 to 85	30	53	M8x10	0.5-1 mm ²	22	530
500300	3.0	-40 to 85	25	57	M8x10	0.5-1 mm ²	22	530
500301	3.5	-40 to 85	30	53	M8x10	0.5-1 mm ²	22	530
500302	4.0	-40 to 85	30	53	M8x10	0.5-1 mm ²	22	450
500303	4.5	-40 to 85	30	53	M8x10	0.5-1 mm ²	22	450
500304	5.0	-40 to 85	30	53	M8x10	0.5-1 mm ²	22	450
500305	6.0	-40 to 85	30	53	M8x10	0.5-1 mm ²	22	450
506495	7.0	-40 to 85	30	53	M8x10	0.5-1 mm ²	22	320
502783	8.0	-40 to 85	30	69	M8x10	0.5-1 mm ²	24	320
504351	9.0	-40 to 85	30	69	M8x10	0.5-1 mm ²	32	320
508667	10.0	-40 to 85	30	69	M8x10	0.5-1 mm ²	32	320
506366	12.0	-40 to 85	30	78	M8x10	0.5-1 mm ²	32	260
508468	15.0	-40 to 85	30	93	M8x10	0.5-1 mm ²	36	260
508668	16.0	-40 to 85	30	93	M8x10	0.5-1 mm ²	32	260
500315	18.0	-40 to 85	35	93	M8x10	0.5-1.5 mm ²	36	190
500316	20.0	-40 to 85	35	93	M8x10	0.5-1.5 mm ²	55	190
500317	25.0	-40 to 85	35	93	M8x10	0.5-1.5 mm ²	66	80
500318	30.0	-40 to 85	40	93	M8x10	0.5-1.5 mm ²	72	100
Aluminium casing								
500319	32.0	-40 to 85	35	135	M8x10	0.5-1.5 mm ²	110	50
500320	35.0	-40 to 85	40	139	M8x10	0.5-1.5 mm ²	127	36
500321	40.0	-40 to 85	40	139	M8x10	0.5-1.5 mm ²	127	36
536406	45.0	-40 to 85	40	103	M8x10	0.5-1.5 mm ²	120	36
500322	50.0	-40 to 85	45	103	M8x10	0.5-1.5 mm ²	150	32
500323	55.0	-40 to 85	45	135	M8x10	0.5-1.5 mm ²	159	32

Parallel Connected Capacitors with Leads

250 V, 50/60 Hz

Capacitors type A

Casing: plastics, white

Fastening: male nipple with nut and washer included

Discharge resistance

Fixing centres: 20 mm

Optional: thermal cut-out,

European wide patent

On request with alternative capacities, connection terminals, mounting options, casing materials or with a thermal fuse as well as versions with IDC terminal for the automatic luminaire wiring

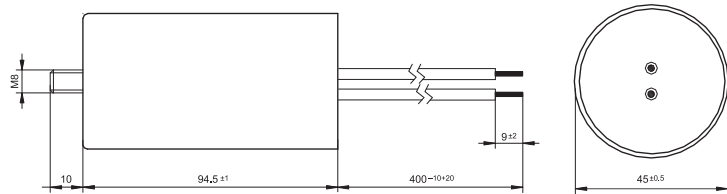

Ref. No.	Capacity μF	Temperature range °C	Ø (D) mm	Length (L) mm	Male nipple/ length (mm)	Lead length mm	Weight g	Unit pcs.
Plastic casing								
552774	2.0	-25 to 85	25	57	M8x10	150	22	400
526169	4.0	-25 to 85	25	63	M8x10	250	31	350
526170	6.0	-40 to 85	28	54	M8x10	250	22	320
526171	8.0	-40 to 85	32	67	M8x10	250	24	220
529665	10.0	-40 to 85	32	67	M8x10	200	32	280
536742	12.0	-25 to 85	30	78	M8x10	150	42	120
529666	16.0	-25 to 85	35	73	M8x10	200	52	120
536741	20.0	-40 to 85	36	92	M8x10	150	85	160
508484	25.0	-25 to 85	40	93	M8x10	250	89	80
536743	30.0	-25 to 85	40	93	M8x10	150	108	80
528554	35.0	-25 to 85	45	94	M8x10	250	173	60
536813	40.0	-25 to 85	45	94	M8x10	400	166	60
528555	45.0	-25 to 85	50	94	M8x10	250	167	50

4

Capacitors for Fluorescent and Discharge Lamps

Idle current compensation	243
Parallel compensation	244
MPP capacitor technology	244-246
Assembly instructions - Capacitors	247-248
Capacitor tables	249-250
General technical details	348-356
Glossary	357-359

Compensation of idle current

When using magnetic ballasts a phase shift occurs between the mains voltage and the current drawn. This phase shift is expressed by the power factor λ , which generally ranges between a value of 0.3 and 0.7 with inductive circuits.

As a result of this phase shift, idle current, which does not boost the efficiency of the lighting unit, is also taken up from the power supply network in addition to real power. Power utility companies therefore require an increase of the power factor to values of over 0.85 for systems exceeding a certain rating (usually upwards of 250 W per external conductor).

Compensation capacitors are used to counteract idle current (by increasing the power factor) and can be connected either in parallel or in series.

Thanks to a power factor of approx. 0.95, electronic ballasts do not need to be operated with compensation capacitors.

Compensation using series capacitors

Series compensation employs a so-called dual circuit (two fluorescent lamp circuits connected in parallel), whereby the capacitor, which is connected in a branch of the circuit, over compensates the inductive idle current to such an extent that it covers the idle current of both ballasts. This type of circuit is only used with fluorescent lamps. As series capacitors are dimensioned for nominal-voltage and ballast tolerances, the lamp in the capacitor branch of the dual circuit operates with a higher current and thus also with a higher rating. Apart from differences in lamp brightness, the power loss in the circuit branch with the capacitor will also be greater.

An advantage of the dual circuit is that it prevents the radiated light from flickering.

The higher current in the so-called capacitive lamp circuit causes an up to 14% increase in lamp rating and a reduction of the lamp service life by as much as 20%. This goes hand in hand with substantial technical, ecological and economic disadvantages.

Series capacitors have to meet very high technical requirements to suit various aspects like temperature, nominal voltage, tolerances of the capacitance values, etc.

As defined by EC directive 2000/55/EC (European Standard EN 50294 governing the measurement of total power consumption), a series capacitor is considered to be a part of the ballast. If the system rating of the capacitive circuit containing the lamps and ballasts is then determined in line with the above definition, rating increases of up to 14% will become apparent in comparison to operation without a series capacitor. Experience has shown that this increased power consumption often means devices fall in the directive's "banned" category. It is therefore strongly advised that due consideration be given to the elevated power consumption values common to using series capacitors for compensation purposes.

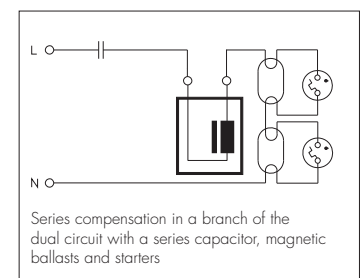

1

2

3

4

5

6

7

8

9

10

Parallel compensation

During parallel compensation, each lamp circuit is assigned to a capacitor connected in parallel to the mains. Only one capacitor providing sufficient capacitance is needed for luminaires with several lamps. Parallel compensation does not affect current flow through a discharge lamp. The requirements placed on parallel capacitors are clearly lower than those for series capacitors.

However, parallel compensation can be subject to limitations when using audio-frequency ripple control pulses if the system operates with a connected rating of over 5 kVA and ripple control frequencies of over 300 Hz are used. The respective power utility company should be consulted for advice in such cases.

Parallel compensation is used in fluorescent lamp and high-pressure discharge lamp circuits.

As parallel compensation offers substantial advantages, this has become the accepted method in the last few years.

Metallised polypropylene film capacitors

Metallised polypropylene film capacitors are designed to compensate the inductive idle current drawn by discharge lamps (fluorescent lamps, high-pressure mercury vapour lamps, high-pressure sodium vapour lamps and metal halide lamps with a ceramic discharge tube) in 50 Hz/60 Hz grids. All Vossloh-Schwabe compensation capacitors for luminaires feature a metallised polypropylene film dielectric. Compensation capacitors help to increase the power factor to values of over λ 0.85 as required by power utility companies.

Construction of metallised polypropylene film capacitors

VS MPP capacitors contain a low-loss metallised polypropylene film dielectric, which is produced by depositing a thin layer of zinc and aluminium or pure aluminium vapour onto one side of the polypropylene film. The contacts at either end of the capacitor coil are created by spraying on a layer of metal and thus guarantee a high current-carrying capacity as well as a low-inductive connection between the terminals and the coils.

All capacitors with a nominal voltage upwards of 280 V are filled with oil or resin after the coils have been inserted and then hermetically sealed. This protects the coils from environmental influences and reduces partial discharge, which contributes to a long service life and stable capacitance. The effects of partial discharge only play a minor role for capacitors with a nominal voltage of under 280 V so that these devices do not need to be filled.

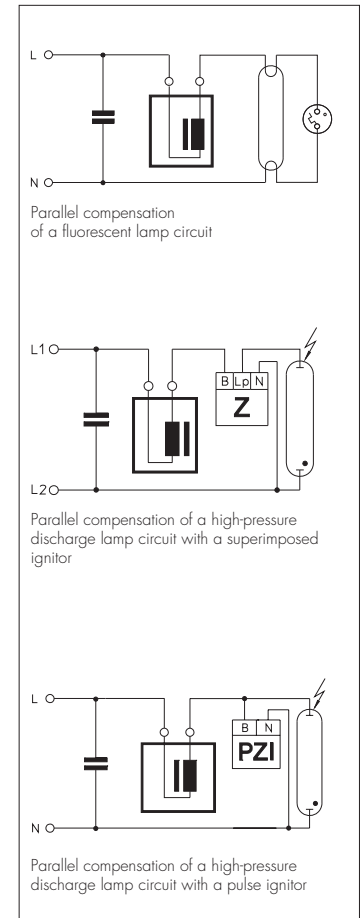

Hermetically sealed, filled capacitors with an overpressure contact breaker should always be used in critical ambient conditions (high humidity, aggressive atmospheres, high temperatures), if the workload and power supply conditions are unknown as well as in situations that demand increased attention to safety.

VS MPP capacitors feature a self-healing dielectric. In the event of a dielectric breakdown in the coil (short circuit), the metal coating vaporises around the breakdown site owing to the high temperature of the transient arc that is produced. Owing to the excess pressure generated during such a breakdown, the metal vapour is pushed outwards away from the centre of the site within the space of just a few microseconds. This creates a coating-free corona around the breakdown site that completely isolates it and means the capacitor remains fully functional during a dielectric breakdown.

The self-healing properties of a capacitor can decrease with time and with constant overloading. This bears the risk of a non-healing breakdown with a permanent short circuit. Therefore self-healing must not be confused with failsafe.

Compensation capacitors are divided into two type families (A and B) in accordance with IEC 61048 A2.

- Type A capacitors defined:
"Self-healing parallel capacitors; without an (overpressure) contact breaker in the event of failure".
They are referred to as unsecured capacitors.
- Type B capacitors defined:
"Self-healing capacitors for series connection in lighting circuits or self-healing parallel capacitors; with an (overpressure) contact breaker in the event of failure".
These are referred to as hermetically sealed, secured capacitors.

In accordance with the standard, the discharge resistor of both capacitor families must be capable of reducing capacitor voltage to a value of under 50 V in the space of 60 seconds after disconnection from the mains.

Capacitors without a contact breaker, unsecured, Type A capacitors in accordance with IEC 61048 A2

IEC 61048 A2-compliant Type A capacitors are self-healing and require no short-circuit protection for normal operation.

Type A capacitors are not fitted with a specific failsafe mechanism as prescribed by the standards for Type B capacitors. Nevertheless, the requirements laid down in the standard for Type A capacitors, especially with regard to temperature and service life tests, are designed to ensure a sufficient degree of device safety and availability **provided the device was correctly installed and operated under calculable and known ambient operating conditions.**

Even so, in very rare cases these capacitors can still develop erratic behaviour due to overloading or at the end of the device's service life.

For that reason, Type A capacitors should only be integrated into luminaires for operation in ambient conditions that are uncritical with regard to flammable materials. Luminaires should feature protection against secondary damage inside and outside the luminaire in the event of a defect.

1

2

3

4

5

6

7

8

9

10

Temperature-protected capacitors are a further development of Type A capacitors and are fitted with a thermal fuse that is triggered by overheating as a result of electrical or thermal overloading. They are tested in accordance with IEC 61048 A2 and comply with Type A requirements. Excess temperatures cause the two wire ends of the element inside the fuse to melt into bead shapes that are fully isolated from each other by special insulation.

In 99% of all the rare cases of critical capacitor failure, this failure is preceded by a gradual increase in the loss factor, which leads to an increase in the winding temperature and thus triggers the thermal fuse.

Vossloh-Schwabe recommends that preference be given to Type A capacitors with a thermal fuse as a matter of course for reasons of safety.

Type A capacitors predominantly feature a plastic casing.

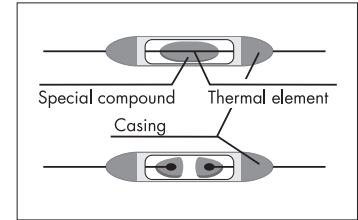

Capacitors with a contact breaker, secured Type B capacitors in accordance with IEC 61048 A2

Self-healing capacitors do not require short-circuit protection for normal operation as they automatically regenerate after a dielectric breakdown. However, as a result of frequent self-healing caused by overloading (voltage, current, temperature) or towards the end of the capacitor's service life, overpressure can build up inside the capacitor (due to the decomposition products of the vaporised polypropylene).

In order to prevent the capacitor casing from exploding in such cases, hermetically sealed capacitors in accordance with IEC 61048 A2 (Type B capacitors) are fitted with an overpressure contact breaker. If excess pressure builds up within these capacitors, e.g. due to undue thermal loading or excessive voltages or at the end of the capacitor's service life, a concertina section opens out that causes the casing to expand lengthways. As a result, the wire contacts rupture at a predetermined breaking point, which irreversibly interrupts the current (contact breaker).

This type of overpressure-protected capacitor with a contact breaker is also referred to as a flame- and explosion-proof capacitor with a break-action mechanism.

Type B capacitors with a contact breaker are available in an aluminium casing.

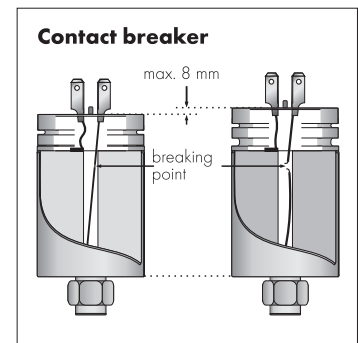

Assembly Instructions for Capacitors

For mounting and installing compensation capacitors

Mandatory regulations

DIN VDE 0100	Erection of low voltage installations
EN 60598	Luminaire – part 1: General requirements and tests
EN 55015	Maximum values and testing methods for radio disturbance of electrical lighting facilities and similar electrical equipment
EN 61000-3-2	Electromagnetic Compatibility (EMC) – part 3: maximum values – main section part 2: maximum values for mains harmonics (ballast input current up to and including 16 A per conductor)
EN 61048	Operating devices for lamps – capacitors for fluorescent lamp circuits and other discharge lamp circuits; general and safety requirements
EN 61049	Operating devices for lamps – capacitors for fluorescent lamp circuits and other discharge lamp circuits; performance requirements

Mechanical mounting

Fastening	Base screw (permissible torque): <ul style="list-style-type: none">• M8x10 – 5 Nm (aluminium casing)• M8x10 – 2.2 Nm (plastic casing)
Mounting location	Any Capacitors fitted with overpressure protection require clearance of at least 10 mm above the contacts so ensure the casing can expand unhindered if the contact breaker is triggered.
Heat transfer	Capacitors should be mounted with the greatest possible clearance to heat sources or lamps. During operation, the temperature measured at the t_c point must not exceed the specified maximum value.
t_c point	The t_c point is defined as an arbitrary point on the surface of the capacitor, which is not specifically marked.
UV Radiation	Capacitors should not be installed in an unprotected manner directly next to any sources of light, heat radiation or convection (ballasts, lamps, heating elements, etc.) as both high temperatures and constant exposure to UV radiation can lead to premature ageing. In combination with high temperatures, UV radiation or other substances and influencing factors, chemicals such as ozone and chlorine can lead to accelerated ageing and material embrittlement.
Thermal load	All capacitor casings are made of flame-retardant materials. However, the potting material, oils and the winding material are flammable and consideration must be taken of this fact during installation. The thermal load of an MKP capacitor is approx. 40 MJ/kg.

1

2

3

4

5

6

7

8

9

10

Safety functions

Type A capacitors

are not fitted with any special protective functions in case of defect.
Temperature-protected capacitors are a further development of Type A capacitors and feature a thermal fuse that is triggered by excess temperatures and disconnects the capacitor from the mains.

Type B capacitors

are fitted with an overpressure contact breaker in case of defects at the end of the capacitor's service life.

Connection

Parallel capacitors for fluorescent lamps:

- Casing diameter 25–30 mm: push-in terminals for 0.5–1 mm² conductors and IDC terminals for H05V-U 0.5 conductors
- Casing diameter > 30 mm: push-in terminals for 0.5–1 mm² conductors

Parallel capacitors for high-pressure lamps:

- Casing diameter 25–30 mm: push-in terminals for 0.5–1 mm² conductors and IDC terminals for H05V-U 0.5 conductors
- Casing diameter > 30 mm: push-in terminals for 0.5–1.5 mm² conductors

Reliability and service life

Provided the max. specified voltage and current loads, temperature, humidity and mains harmonics values are observed,

- approx. 50,000 hours for overpressure-protected parallel capacitors
- approx. 30,000 hours for parallel capacitors without overpressure protection in a plastic or aluminium casing

A 3–10% decrease in capacitance must be expected in the course of the capacitor's service life.

Failure rate: 1‰ per 1,000 operating hours when maximum voltage, current and temperature values are not exceeded.

Electrical installation

Nominal voltage 250 V, 50/60 Hz; 280 V, 50/60 Hz; 450 V, 50/60 Hz
(dependent on type)

Capacitance tolerance

±10% (±5% dependent on type)

Temperature range

–25/–40 °C to +85/+100 °C (dependent on type, details see product page)

Optional thermal fuse

Relative humidity Class F for Type B capacitors: 75% annual mean, 95% peak value on 30 days
Class G for Type A capacitors: 65% annual mean, 85% peak value on 30 days

Condensation Impermissible

Capacitors for fluorescent lamp circuits

Lamp Output W	Type	Parallel compensation capacitor ($\mu\text{F} \pm 10\%$ at 250 V)		Series compensation capacitor ($\mu\text{F} \pm 4\%$)		
		220–240 V/50 Hz μF	220–230 V/60 Hz μF	220 V/50 Hz μF	230 V/50 Hz μF	220 V/60 Hz μF
4	T	2**	2**	–	–	–
6	T	2**	2**	–	–	–
8	T	2**	2**	–	–	–
10	T	2	2	–	–	–
13	T	2	2	–	–	–
14	T	4.5	4.5	–	–	–
15	T	3.5 or 4*	3 or 4*	–	–	–
16	T	2	2	–	–	–
18	T	4.5 or 4*	4**	2.9/440 V	2.8/480 V	2.4/440 V
20	T	4.5 or 4*	4**	2.9/440 V	2.8/480 V	2.4/440 V
23	T	3.5	3	–	–	–
25	T	3.5	3	–	2.3/450 V	–
30	T	4.5	4	3/420 V	2.9/450 V	–
36	T	4.5	4	3.6/420 V	3.4/450 V	3/420 V
36-1m	T	6.5	–	–	–	–
38	T	4.5	4	–	–	–
40	T	4.5	4	3.6/420 V	3.4/450 V	3/420 V
42	T	6.5	–	–	–	–
58	T	7	6	5.7/450 V	5.3/450 V	4.8/420 V
65	T	7	6	5.7/450 V	5.3/450 V	4.8/420 V
70	T	6	–	–	–	–
75	T	6	–	–	–	–
80	T	9	8	–	7.2/420 V	–
85	T	8	6.5	–	8.4/420 V	–
100	T	10	9	–	–	–
115	T	18	16	–	–	–
140	T	14	14	–	–	–
160	T	14	14	–	–	–
16	T-U	2	2	–	–	–
18/20	T-U	4.5 or 4*	4**	2.9/440 V	2.8/480 V	2.4/440 V
36/40	T-U	4.5	4	3.6/420 V	3.4/450 V	3/420 V
58/65	T-U	7	6	–	–	–
22	T-R	5	4.5	–	3.2/440 V	–
32	T-R	5	4.5	–	3.4/450 V	–
40	T-R	4.5	4	3.6/420 V	3.4/450 V	3/420 V
5/7/9/11	TC-S	2**	2**	–	–	–
10	TC-D/TC-T	2	2	–	–	–
13	TC-D/TC-T	2	2	–	–	–
18	TC-D/TC-T	2	2	–	–	–
26	TC-D/TC-T	3.5	3	–	–	–
10	TC-DD	2	2	–	–	–
16	TC-DD	2	2	–	–	–
21	TC-DD	3	3	–	–	–
28	TC-DD	3.5	3	–	–	–
38	TC-DD	4.5	4	–	–	–
18	TC-L/TC-F	4.5 or 4*	4**	–	–	–
24	TC-L/TC-F	4.5	4	–	–	–
34	TC-L/TC-F	4.5	4	–	–	–
36	TC-L/TC-F	4.5	4	–	–	–

*) Two lamps connected to a ballast in series

**) Applies to one lamp connected to a ballast or two lamps connected in series

1

2

3

4

5

6

7

8

9

10

Capacitors for

Lamp		Compensation capacitor ($\mu\text{F} \pm 10\%$)			
Output W	Type	220/230/240/252 V 50 Hz (μF)	220 V 60 Hz (μF)	380/400/420 V, 50 Hz (μF)	380 V/60 Hz 60 Hz (μF)

high-pressure mercury vapour lamp circuits

50	HM	7	6		
80	HM	8	7		
125	HM	10	10		
250	HM	18	15		
400	HM	25	25		
700	HM	40	35		
1000	HM	60	50		

high-pressure sodium vapour lamp circuits

35	HS	6	5		
50	HS	8	8		
70	HS	12	10		
100	HS	12	10		
150	HS	20	16		
250	HS	32	25		
400	HS	45	40		
600	HS	65	55	25	20
750	HS	70	60	25	25
1000	HS	100	85		

metal halide lamp circuits

35	HI	6	5		
70	HI	12	10		
100	HI	12	10		
150	HI	20	16		
250	HI	32	25		
400	HI	35/45	35/45		
1000	HI	85	75		
2000	HI	125	125		
2000	HI			37	37
2000	HI			60	60
2000	HI			60	60
2000	HI			100	100

Capacitors for low-pressure discharge lamp circuits

Lamp		Compensation capacitor ($\mu\text{F} \pm 10\%$)
Output W	Type	230 V/50 Hz μF
35	LS	20
55	LS	20
90	LS	26
135	LS	40
180	LS	40

1

2

3

4

5

6

7

8

9

10

ELECTRONIC AND ELECTRO- MAGNETIC TRANSFORMERS



FOR LOW-VOLTAGE HALOGEN INCANDESCENT LAMPS

The operating voltage of low-voltage halogen lamps is normally 12 V (6 and 24 V are also used for special applications). As a result, transformers are required in order to connect such lamps to the normal mains supply within buildings, whereby international requirements governing building installations specify that safety transformers or converters (electronic transformers) be exclusively used for such purposes nowadays. These devices are designed in such a way as to prevent both personal injury and the outbreak of fire should the lighting system malfunction.

Electronic converters

The following chapter provides an overview of the VS range of electronic converters that feature a whole range of advantages: light and compact, superior efficiency (approx. 95%), short-circuit protection, integrated overheating and overload protection, soft start for longer lamp life, broad part-load range and dimmability.

Electromagnetic safety transformers

The following chapter also provides an overview of Vossloh-Schwabe's range of electromagnetic transformers. The range is split into protection class II transformers and protection class I built-in transformers whose ultra-flat design make them particularly user-friendly. Lamp brightness can be regulated using conventional phase dimmers for low-voltage halogen lamps.



5

Transformers for Low-voltage Halogen Incandescent Lamps

Independent electronic converters	254
Electromagnetic safety transformers	255-257
Technical details for incandescent lamps	314-327
General technical details	348-356
Glossary	357-359

1

2

3

4

5

6

7

8

9

10

Independent Electronic Converters – LiteLine

Electronic safety converters for low-voltage halogen incandescent lamps 12 V
 Casing: heat-resistant polyamide
 Mains frequency: 50–60 Hz
 Protection against "no load" operation
 Protection against short-circuit:
 electronic switch-off with automatic restart
 Electronically controlled overload and temperature protection
 Suitable for installation in furniture and on combustible surfaces
 Power factor: > 0.95
 Efficiency: ≥ 94%
 Dimming: optional with phase-cutting leading-edge or phase-cutting trailing-edge dimmer
 Screw terminals: 2.5 mm²
 (EST 60/12.635 primary: 4 mm²)
 Quantity of screw terminals:
 1x2-poles primary
 1x2-poles secondary
 With integrated cord grip
Protection class II
 SELV
 Degree of protection: IP20
 RFI-suppressed

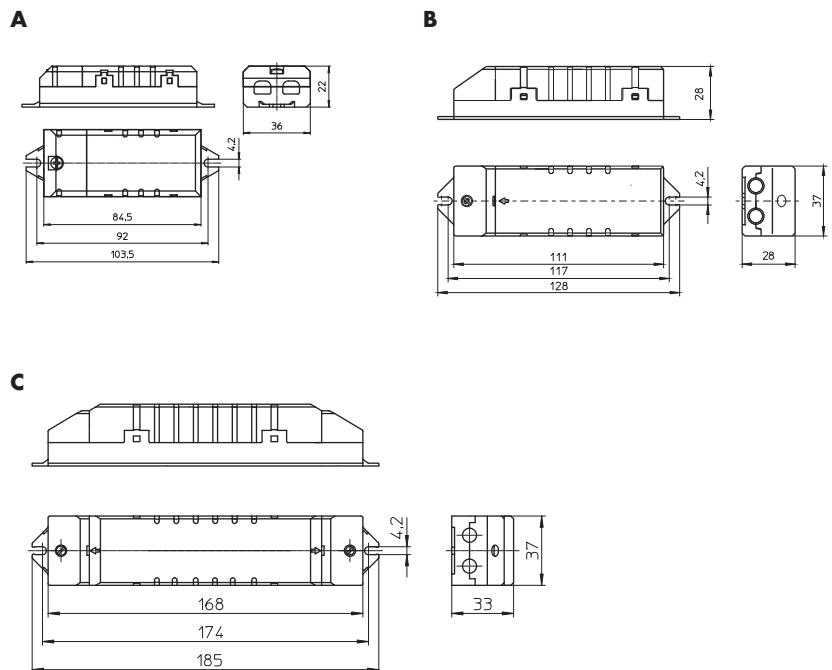
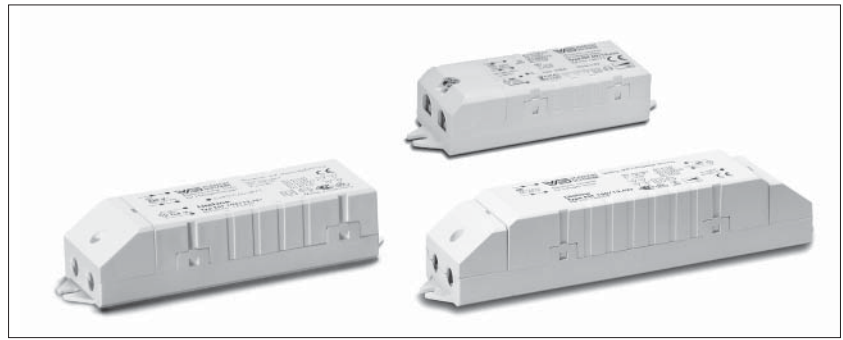

Type	Ref. No.	Capacity range (W)	Voltage (V)		Nominal current A	Ambient temperature t_a (°C)	Casing temperature t_c (°C)	Drawing	Weight g
			prim. (±10%)	sec.					
Dimensions: 22x36x103.5 mm									
EST 60/12.635	186173	10–60	220–240	10.2–12	0.258–0.260	–20 to 45	max. 85	A	70
Dimensions: 28x37x128 mm									
EST 70/12.380	186072	20–70	230–240	11.3–11.7	0.30–0.31	–20 to 45	max. 70	B	85
EST 105/12.381	186077	20–105	230–240	11.2–11.7	0.435–0.445	–20 to 40	max. 85	B	95
Dimensions: 33x37x185 mm									
EST 150/12.622	186098	50–150	230–240	11.2–11.6	0.595–0.605	–20 to 45	max. 85	C	175

Super-thin Electromagnetic Built-in Transformers 20–105 VA

Shape: 28x41 mm

Electromagnetic safety transformers
for low-voltage halogen incandescent lamps 12 V
Vacuum-impregnated with polyester resin
Screw terminals: 0.5–2.5 mm²
Protection class I
For these transformers without thermal cut-out,
a slow-acting fuse should be installed in the
wiring on site

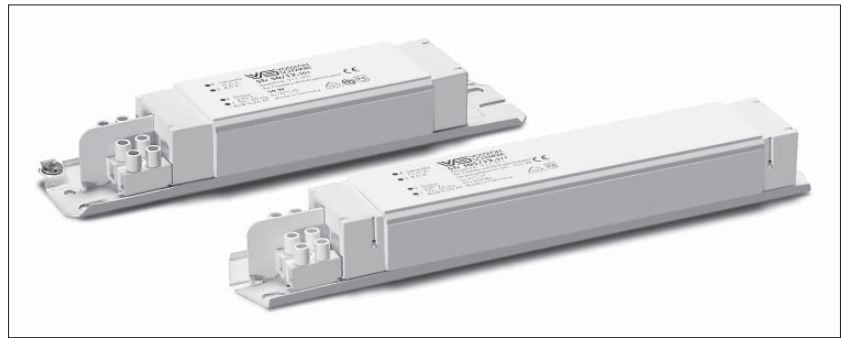

A

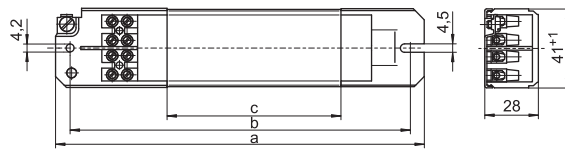

B

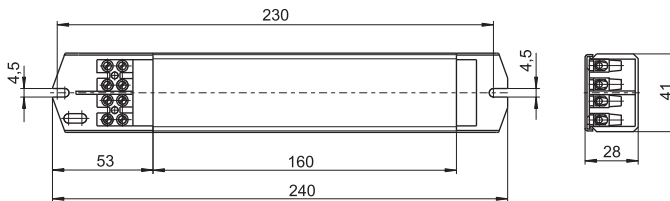

Safety transformers											Primary fuse
Type	Ref. No.	Capacity range W	50, 60 Hz V prim.	60 Hz V sec.	Ambient temperature t _a (°C)	Drawing	a mm	b mm	c mm	Weight kg	AT
220 V/50, 60 Hz											
STr 50/12.207	500843	35–50	220	11.5	40/B	A	175	165	83	0.73	0.250
230 V/50, 60 Hz											
STr 20/12.306	161781	15–20	230	11.5	60/B	A	155	140	63	0.55	0.125
STr 50/12.301	161757	35–50	230	11.5	50/B	A	195	180	92	0.80	0.250
STr 50/12.342	507181	35–50	230	11.5	40/B	A	175	165	83	0.73	0.250
STr 60/12.338	179604	40–60	230	11.5	50/F	A	195	180	92	0.80	0.315
STr 105/12.311	170002	60–105	230	11.5	30/F	B	240	230	160	1.33	0.500
240 V/50, 60 Hz											
STr 50/12.401	169830	35–50	240	11.5	45/B	A	195	180	92	0.80	0.250
STr 50/12.422	502592	35–50	240	11.5	40/B	A	175	165	83	0.73	0.250
STr 105/12.406	169125	60–105	240	11.5	50/H	B	240	230	160	1.33	0.500
127 V/60 Hz											
STr 50/12.109	525791	35–50	127	11.5	40/F	A	155	140	63	0.55	0.500

1

2

3

4

5

6

7

8

9

10

Super-thin Electromagnetic Built-in Transformers with Thermal Cut-out 20–105 VA

Shape: 28x41 mm

Electromagnetic safety transformers
for low-voltage halogen incandescent lamps 12 V
Vacuum-impregnated with polyester resin
Screw terminals: 0.5–2.5 mm²
Protection class I
Temperature switch with self-holding protection
against overheating,
no primary fuse necessary

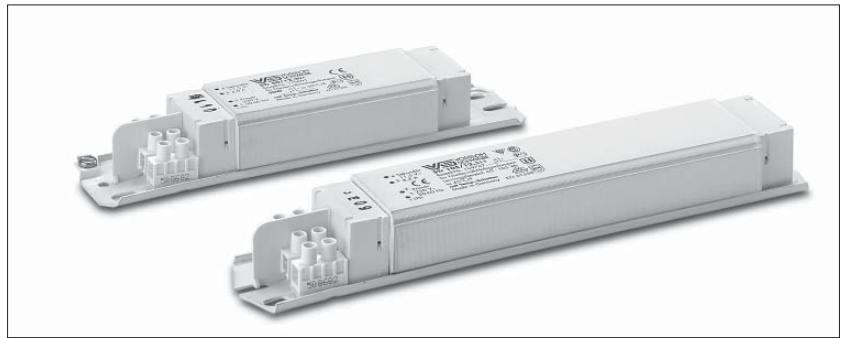

A

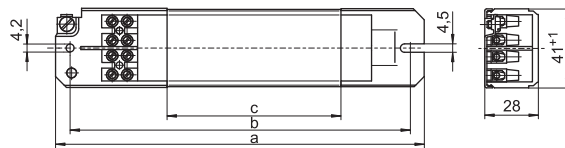

B

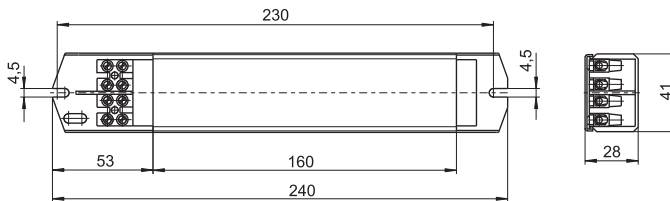

Type	Ref. No.	Capacity range W	50, 60 Hz		Ambient temperature t _a [°C]	Drawing	a mm	b mm	c mm	Weight kg
			V prim.	V sec.						
230 V/50, 60 Hz										
STr 20/12.306	161860	15–20	230	11.5	60/B	A	155	140	63	0.55
STr 50/12.337	179444	35–50	230	11.5	50/F	A	175	165	83	0.73
STr 50/12.301	170091	35–50	230	11.5	50/B	A	195	180	92	0.80
STr 60/12.338	179608	40–60	230	11.5	50/F	A	195	180	92	0.80
STr 105/12.311	169747	60–105	230	11.5	45/F	B	240	230	160	1.33
240 V/50, 60 Hz										
STr 50/12.401	169748	35–50	240	11.5	45/B	A	195	180	92	0.80
STr 105/12.406	161935	60–105	240	11.5	50/H	B	240	230	160	1.33
127 V/60 Hz										
STr 50/12.109	537403	35–50	127	11.5	40/F	A	155	140	63	0.55

Compact Electromagnetic Transformers 70–300 VA

Shape: 85x85 mm (200 VA)

Shape: 99x85 mm (300 VA)

Built-in electromagnetic safety transformers
for low-voltage halogen incandescent lamps 12 V
Fully encapsulated transformer in a plastic casing
Mains frequency: 50–60 Hz
Built-in primary fuse and temperature switch
Connections

primary: lead

secondary: screw terminals up to 6 mm²

Degree of protection: IP24

Protection class II

Suitable for installation in furniture
and on combustible surfaces

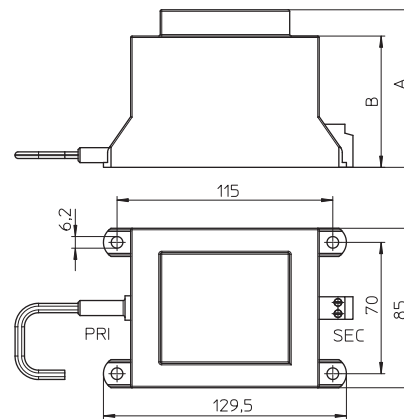
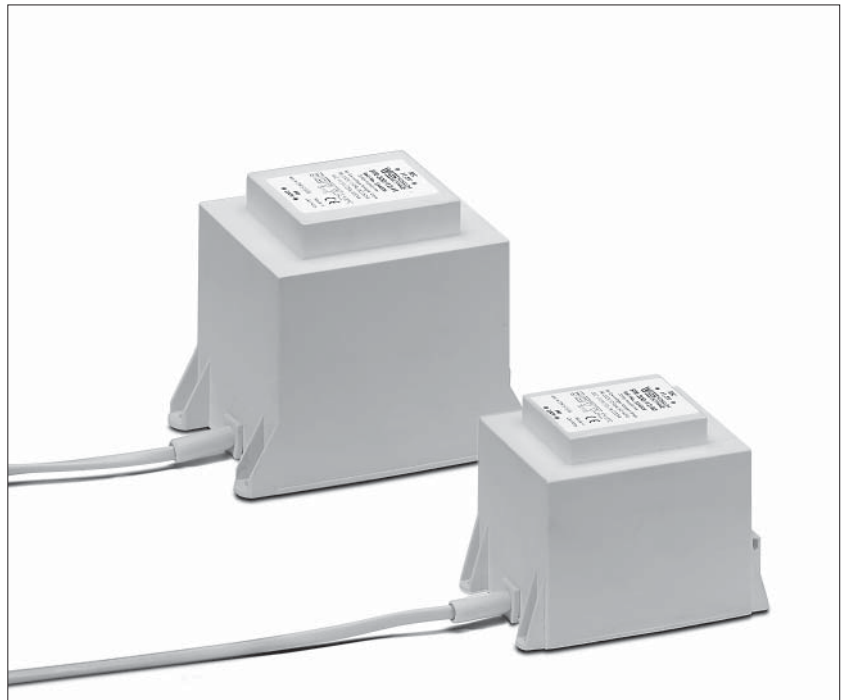

Type	Ref. No.	Capacity range W	Voltage AC V -10%+6%		Ambient temperature t_a °C	A mm	B mm	Weight kg
			prim.	sec.				
230 V/50, 60 Hz								
STr 200/12.40	554325	70–200	230	12	40	85	70	2.9
STr 300/12.41	554326	150–300	230	12	40	99	84	3.9

LOW- AND MAINS VOLTAGE LAMP HOLDERS

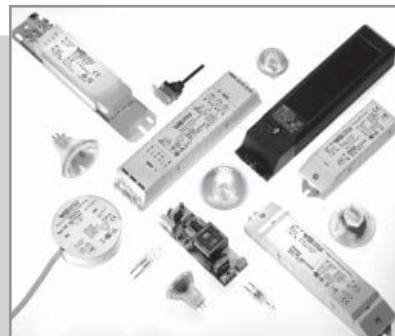

LAMP HOLDERS FOR HALOGEN INCANDESCENT LAMPS

As the tungsten-halogen cycle and the high lamp current can cause very high temperatures when operating low-voltage halogen lamps, close attention must be paid to the luminaire's thermal conditions and components must be made of high-grade materials.

VS lampholders for low-voltage halogen lamps

The following chapter contains Vossloh-Schwabe's comprehensive range of connection elements, lampholders and accessories for safe and reliable installation in accordance with the latest regulations and developments.

VS lampholders for mains voltage halogen lamps

The following chapter contains Vossloh-Schwabe's comprehensive range of lampholders for single-ended halogen lamps (GU/GZ10 and G9 bases), lampholders for bayonet lamps (B15d and B22d bases) as well as lampholders for double-ended tubular lamps (R7s base).



5

Lampholders for Halogen Incandescent Lamps

Lampholders for low-voltage halogen incandescent lamps

G4, GZ4, G5.3, GX5.3, G6.35, GY6.35 lampholders, accessories
G4 lampholders, GZ4 lamp connectors
Lampholders with separate mounting spring for GU4 lamps
GX5.3 lamp connectors
GU5.3 lampholders
Lampholders with separate mounting spring for GU5.3 lamps
G6.35, GY6.35 lampholders, GZ6.35 lamp connectors
G53 lamp connectors

260-267

260-261
261-263
264
265
265
266
267
267

Lampholders for mains voltage halogen incandescent lamps

B15d, BA15d lampholders
G9 lampholders, accessories
GU10, GZ10 lampholders, accessories
R7s ceramic lampholders
R7s metal lampholders
Connection boxes
Connectors

268-277

268
268-270
271-272
273-275
275
276
277

Technical details for incandescent lamps

General technical details
Glossary

314-327

348-356
357-359

1

2

3

4

5

6

7

8

9

10

G4, GZ4, G5.3, GX5.3, G6.35, GY6.35 Lampholders, Accessories

For low-voltage halogen incandescent lamps

The lampholders listed in this chapter permit the use of lamps with different bases. It is important to ensure that under no circumstances a lamp

with a smaller pin diameter is used if a lamp with a larger pin diameter has already been used.

G/GZ4, G/GX5.3, G/GY6.35 lampholder
 Casing: LCP, natural, T270
 Nominal rating: 8/24 (for G4/GZ4 lamps: 4/24)
 Multipoint contacts: CuNiZn
 Push-in terminals for stranded conductors with ferrule on bare end of core \varnothing 1.4–1.8 mm
 Fixing holes for screws M3
 Weight: 2.4 g, unit: 1000 pcs.
 Type: 33300
Ref. No.: 109547

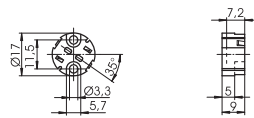

Cover caps
 For push-fit onto lampholders type 333
 External thread 20.8x2
 Material: LCP, natural
 Moulded thread: M10x1
 Weight: 3.8 g, unit: 1000 pcs.
 Type: 97255
Ref. No.: 109548

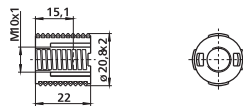

Screw rings
 For components with external thread 20.8x2
 Weight: 1.7/1.4 g, unit: 1000 pcs.
 Type: 97257
Ref. No.: 109550 PPS, black
Ref. No.: 507490 LCP, natural

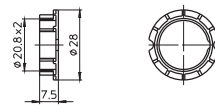

G/GZ4, G/GX5.3, G/GY6.35 lampholder
 Casing: LCP, natural, T270
 Nominal rating: 8/24 (for G4/GZ4 lamps: 4/24)
 Multipoint contacts: CuNiZn
 Push-in terminals for stranded conductors with ferrule on bare end of core \varnothing 1.4–1.8 mm
 Fixing holes for screws M3
 Weight: 2.6 g, unit: 1000 pcs.
 Type: 33400
Ref. No.: 109674

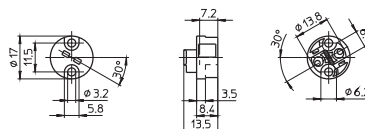

Lampholders for Halogen Incandescent Lamps

G/GZ4, G/GX5.3, G/GY6.35 lampholder

Casing: ceramic, cover plate: mica

T350

Nominal rating: 10/24

Contacts: Ni

Leads: Cu nickel-plated, stranded conductors

0.75 mm², PTFE-insulation, length: 140 mm

Fixing holes for screws M3

Weight: 6.8 g, unit: 500 pcs.

Type: 32400

Ref. No.: 100939

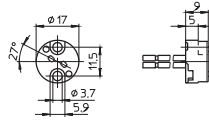

1

2

G/GZ4, G/GX5.3, G/GY6.35 lampholder

Casing: ceramic, cover plate: mica

T300

Nominal rating: 10/24

Multipoint contacts: CuNiZn

Leads: Cu nickel-plated, stranded conductors

0.75 mm², PTFE-insulation, length: 140 mm

Fixing holes for screws M3

Weight: 7.1 g, unit: 1000 pcs.

Type: 32700

Ref. No.: 101258

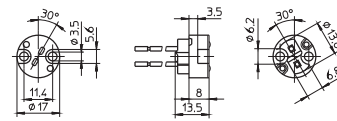

3

4

G/GZ4, G/GX5.3, G/GY6.35 lampholder

Casing: ceramic, cover plate: mica

T300, nominal rating: 10/24

Multipoint contacts: CuNiZn

Leads: Cu nickel-plated, stranded conductors

0.75 mm², PTFE-insulation, length: 140 mm

Fixing plate: zinc-coated polished steel

Fixing holes for screws M3

Weight: 8.8 g, unit: 1000 pcs.

Type: 32720

Ref. No.: 101274

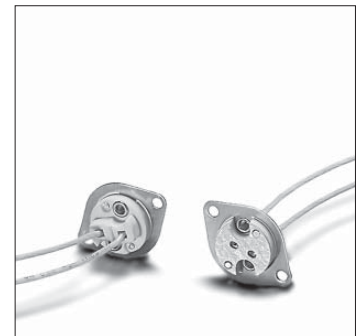
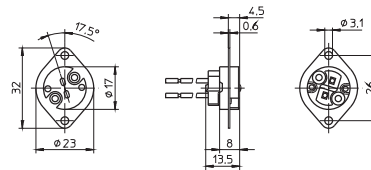

5

6

G4 Lampholders, GZ4 Lamp Connectors

For low-voltage halogen incandescent lamps

G4 lampholder, GZ4 lamp connector

Casing: PPS, black, T240

Nominal rating: 4/24, multipoint contacts: steel

Leads: Cu tinned, stranded conductors 0.75 mm²,

Si-insulation, length: 140 mm

Option for lateral wiring

Lampholder height: 16 mm

Fixing holes for screws M3

Weight: 5.7 g, unit: 1000 pcs.

Type: 30400

Ref. No.: 530024

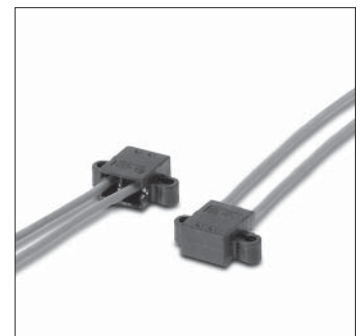
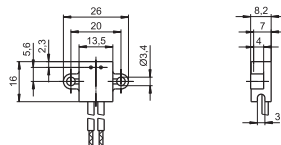

7

8

9

10

Lampholders for Halogen Incandescent Lamps

G4 lampholder

Casing: PPS, black, T200

Nominal rating: 2/24

Multipoint contacts: CuNiZn

Leads: Cu tinned, stranded conductors 0.75 mm²,
Si-insulation brown/blue, length: 140 mm

Push-in fixing

Weight: 4.4 g, unit: 1000 pcs.

Type: 30485

Ref. No.: 535988

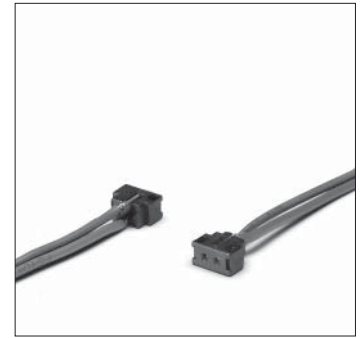

1

2

G4 clip-in tube lampholder

With earth contact

Casing: PPS, black, T200

Nominal rating: 2/24

Multipoint contacts: CuNiZn

Lead: Cu tinned, stranded conductors 0.75 mm²,
Si-insulation blue, length: 140 mm

Push-in fixing

Weight: 2.7 g, unit: 1000 pcs.

Type: 30471

Ref. No.: 108449

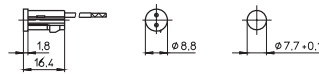

3

4

G4 clip-in tube lampholder

With integrated cable holder for Teflon conductor

Casing: PPS, black, T200

Nominal rating: 2/24

Multipoint contacts: CuNiZn

Leads: Cu tinned, stranded conductors 0.61 mm²,
FEP-insulation brown/blue, length: 140 mm

Push-in fixing

Weight: 8.1 g, unit: 1000 pcs.

Type: 30470

Ref. No.: 520865

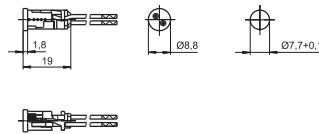

5

6

G4 lampholder

Casing: PPS, black, T240

Nominal rating: 4/24

Multipoint contacts: steel

Leads: Cu tinned, stranded conductors 0.75 mm²,
Si-insulation, length: 140 mm

For push-fit onto the lamp

Weight: 4.7 g, unit: 1000 pcs.

Type: 34000

Ref. No.: 507105

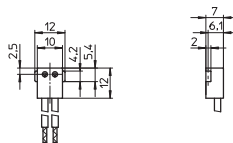

7

8

9

10

Lampholders with Separate Mounting Spring for GU4 Lamps

For low-voltage halogen incandescent lamps

G/GZ4, G/GX5.3, G/GY6.35 lampholder
 Casing: LCP, natural, T270
 Nominal rating: 8/24 (for G4/GZ4 lamps: 4/24)
 Multipoint contacts: CuNiZn
 Push-in terminals for stranded conductors
 with ferrule on bare end of core \varnothing 1.4–1.8 mm
 Fixing holes for screws M3
 For cover cap (see p. 268)
 Weight: 2.4 g, unit: 1000 pcs.
 Type: 33300

Ref. No.: 109547

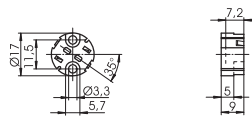

GU4 mounting spring for lamp
 Material: stainless steel
 For push-fit onto lampholders type 333 and 32210
 Weight: 0.8 g, unit: 1000 pcs.
 Type: 94095

Ref. No.: 109553

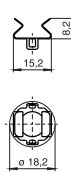

G/GZ4, G/GX5.3, G/GY6.35 lampholder
 Casing: ceramic, cover plate: mica
 T350
 Nominal rating: 10/24
 Contacts: Ni
 Leads: Cu nickel-plated, stranded conductors
 0.75 mm², PTFE-insulation, length: 140 mm
 Fixing holes for screws M3
 Weight: 6.8 g, unit: 500 pcs.
 Type: 32400

Ref. No.: 100939

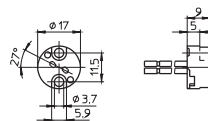

GU4 mounting spring for lamp
 Material: stainless steel
 The mounting spring has to be fastened
 to the lampholder 100939.
 The luminaire manufacturer is responsible
 for the attachment.
 Weight: 1.6 g, unit: 1000 pcs.
 Type: 94071

Ref. No.: 108678

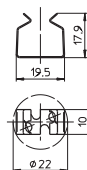

GX5.3 Lamp Connectors

For low-voltage halogen incandescent lamps

GX5.3 lamp connectors

Casing: ceramic, cover plate: mica
T300, nominal rating: 10/24

Multipoint contacts: Ni

Leads: Cu nickel-plated, stranded conductors
0.75 mm², PTFE-insulation, length: 140 mm

Weight: 7.8/8.5 g, unit: 500 pcs.

Type: 32600 holes for screws M3

Ref. No.: 101162

Type: 32620 threaded bushes M3

Ref. No.: 101207

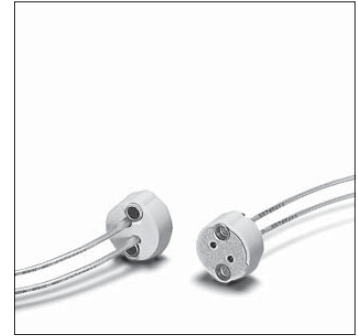
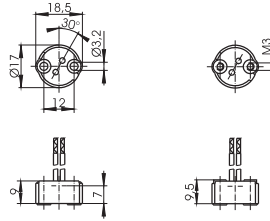

GU5.3 Lampholders

For low-voltage halogen incandescent lamps

GU5.3 lampholder

Casing: ceramic, cover plate: mica
T350, nominal rating: 10/24

Contacts: Ni

Leads: Cu nickel-plated, stranded conductors
0.75 mm², PTFE-insulation, length: 140 mm

Fixing holes for screws ST2.9

Mounting spring for lamp: stainless steel

Weight: 9.1 g, unit: 1000 pcs.

Type: 32480

Ref. No.: 106457

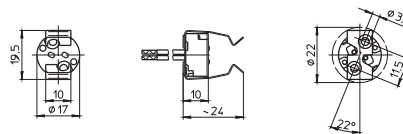

GU5.3 lampholders

Casing: ceramic, cover plate: mica
T300, nominal rating: 10/24, multipoint contacts: Ni

Leads: Cu nickel-plated, stranded conductors
0.75 mm², PTFE-insulation, length: 140 mm

Mounting spring for lamp: stainless steel

Weight: 11/12 g, unit: 500 pcs.

Type: 32680 holes for screws M3

Ref. No.: 101248

Type: 32690 threaded bushes M3

Ref. No.: 101253

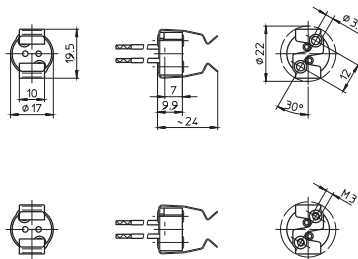

Lampholders with Separate Mounting Spring for GU5.3 Lamps

For low-voltage halogen incandescent lamps

G/GZ4, G/GX5.3, G/GY6.35 lampholder
 Casing: LCP, natural, T270
 Nominal rating: 8/24 (for G4/GZ4 lamps: 4/24)
 Multipoint contacts: CuNiZn
 Push-in terminals for stranded conductors
 with ferrule on bare end of core \varnothing 1.4–1.8 mm
 Fixing holes for screws M3
 For cover cap (see p. 260)
 Weight: 2.4 g, unit: 1000 pcs.
 Type: 33300

Ref. No.: 109547

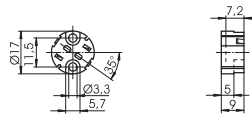

GU5.3 mounting spring for lamp
 Material: stainless steel
 For push-fit onto lampholders type 333
 Weight: 1.1 g, unit: 1000 pcs.
 Type: 94096

Ref. No.: 109554

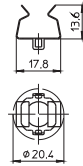

G/GZ4, G/GX5.3, G/GY6.35 lampholder
 Casing: ceramic, cover plate: mica
 T350
 Nominal rating: 10/24
 Contacts: Ni
 Leads: Cu nickel-plated, stranded conductors
 0.75 mm², PTFE-insulation, length: 140 mm
 Fixing holes for screws M3
 Weight: 6.8 g, unit: 500 pcs.
 Type: 32400

Ref. No.: 100939

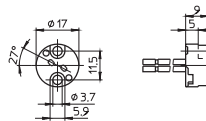

GU5.3 mounting spring for lamp
 Material: stainless steel
 The mounting spring has to be fastened
 to the lampholder 100939.
 The luminaire manufacturer is responsible
 for the attachment.
 Weight: 2 g, unit: 1000 pcs.
 Type: 94060

Ref. No.: 106256

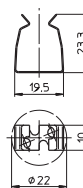

G6.35, GY6.35 Lampholders, GZ6.35 Lamp Connectors

For low-voltage halogen incandescent lamps

G/GY6.35 lampholder, GZ6.35 lamp connector

Casing: ceramic, cover plate: mica

T300, nominal rating: 10/24

Multipoint contacts: Ni

Leads: Cu nickel-plated, stranded conductors

0.75 mm², PTFE-insulation, length: 140 mm

Fixing holes for screws M3

Lamp fixing holes: diagonal

Weight: 11 g, unit: 500 pcs.

Type: 30300

Ref. No.: 100662

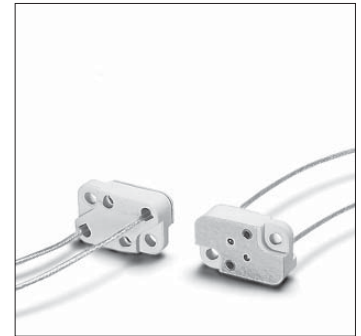
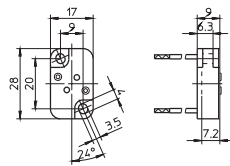

G53 Lamp Connectors

For low-voltage halogen incandescent lamps

G53 lamp connector

Casing: PPS, black

Nominal rating: 10/24

Contacts: CuNiZn

Lead: Cu tinned, stranded conductors 0.75 mm²,

Si-insulation, length: 140 mm

Fixing hole for screw M4

Lead exit: lateral

Weight: 4.4 g, unit: 1000 pcs.

Type: 33100

Ref. No.: 107694

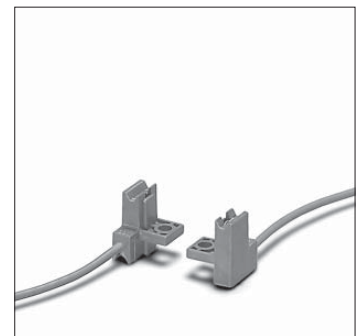
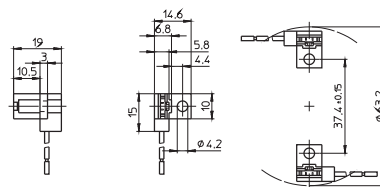

1

2

3

4

5

6

7

8

9

10

B15d, BA15d Lampholders

For low-voltage and mains voltage halogen incandescent lamps

One-piece contact pins with screw terminals to reduce voltage drop.

When using lampholders without cap it has to be ensured protection from electric shock as well as sufficient creepage distances and clearances from live parts on the back of lampholders.

B15d, BA15d lampholders

Casing with fixing flange: zinc-coated polished steel

Insert: ceramic, T230

Nominal rating: 8/250

Fixing holes for screws M3

Weight: 15/16 g, unit: 500 pcs.

Type: 78100

Ref. No.: 102923

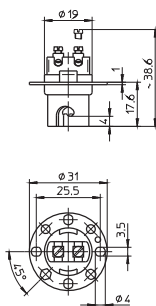

G9 Lampholders, Accessories

For mains voltage halogen incandescent lamps

For luminaires of protection class II

G9 lampholder

Casing: ceramic, cover plate: LCP, natural T300, nominal rating: 2/250

Push-in twin terminals for stranded conductors with ferrule on bare end of core \varnothing 1.4–1.8 mm

Weight: 7.5 g, unit: 1000 pcs.

Type: 33800

Ref. No.: 509357

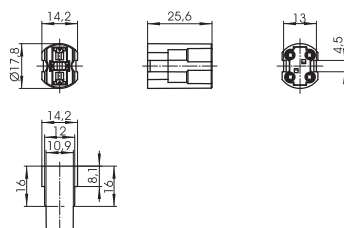

Lampholders for Halogen Incandescent Lamps

Metal screw rings

For components with external thread 20.8x2

Material: zinc-coated polished steel

Weight: 1.6/2 g, unit: 1000 pcs.

Type: 93034 Ø 27 mm, height: 7 mm

Ref. No.: 509110

Type: 93035 Ø 27 mm, height: 11 mm

Ref. No.: 509118

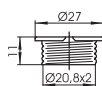
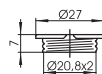

G9 lampholder

Casing: ceramic, cover plate: LCP, natural

T270, nominal rating: 2/250

Push-in twin terminals for stranded conductors with ferrule on bare end of core Ø 1.4–1.8 mm

Fixing holes for screws M3

Weight: 14.4 g, unit: 1000 pcs.

Type: 33500

Ref. No.: 502004

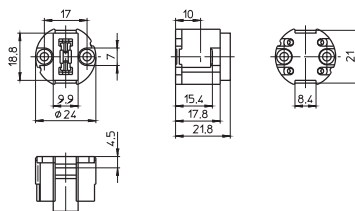

Cover caps for G9 lampholder 502004

Material: LCP, natural

External thread 28x2 IEC 60399

Fixing holes for screws M3

Weight: 8.7/4.6 g, unit: 1000 pcs.

Type: 83310 female nipple: M10x1

Ref. No.: 505951

Type: 97268 moulded thread: M10x1

Ref. No.: 501942

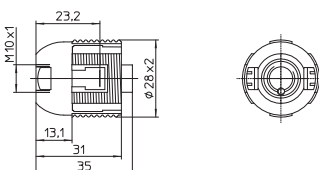

Screw ring

For components with external thread 28x2

Material: PPS, black

Ø 34 mm, height: 7.5 mm

Weight: 1.9 g, unit: 1000 pcs.

Type: 05202

Ref. No.: 502503

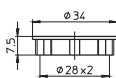

GU10, GZ10 Lampholders, Accessories

For mains voltage halogen incandescent lamps

GU10, GZ10 lampholders
 Casing: LCP, natural, T270, nominal rating: 2/250
 Push-in twin terminals for stranded conductors
 with ferrule on bare end of core \varnothing 1.4–1.8 mm
 Fixing holes for screws M3
 Weight: 7 g, unit: 1000 pcs.

Type: 31000/31010

Ref. No.: 108979 GU10, GZ10 lampholder

Ref. No.: 109007 GU10 lampholder

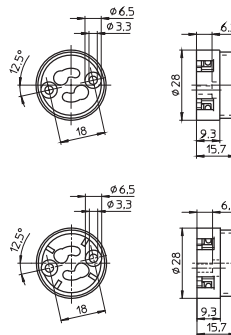

GU10, GZ10 lampholders
 For luminaires of protection class II
 Casing: LCP, natural, T270, nominal rating: 2/250
 Push-in twin terminals for stranded conductors
 with ferrule on bare end of core \varnothing 1.4–1.8 mm
 Fixing holes for screws M3
 Weight: 8 g, unit: 1000 pcs.

Type: 31020/31030

Ref. No.: 502111 GU10, GZ10 lampholder

Ref. No.: 502112 GU10 lampholder

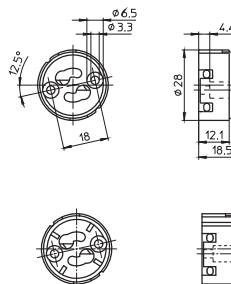

Cover cap for GU10, GZ10 lampholders type 310
 Material: PA GF, black
 Moulded thread: M10x1
 Fixing holes for screws M3
 Weight: 3.4 g, unit: 1000 pcs.
 Type: 97244

Ref. No.: 109411

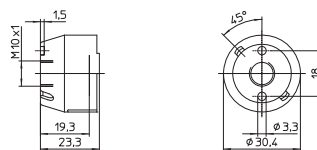

Cover cap for lampholders 502111/502112
 External thread 32x2
 Material: LCP, natural
 Moulded thread: M10x1
 Weight: 6 g, unit: 1000 pcs.
 Type: 97320

Ref. No.: 502064

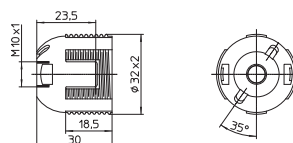

1

2

3

4

5

6

7

8

9

10

Lampholders for Halogen Incandescent Lamps

Screw ring

For components with external thread 32x2

Ø 38.9 mm, height: 7.5 mm

Material: PPS, black

Weight: 2.3 g, unit: 1000 pcs.

Type: 97282

Ref. No.: 502416

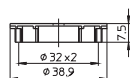

GU10, GZ10 lampholders

Casing: steatite, cover plate: PPS

T240, nominal rating: 2/250

Push-in terminals for stranded conductors with ferrule on bare end of core Ø 1.5–1.8 mm

Fixing holes for screws M3

Weight: 13.6/14 g, unit: 500 pcs.

Type: 31755/31705

Ref. No.: 535034 GU10, GZ10 lampholder

Ref. No.: 535032 GU10 lampholder

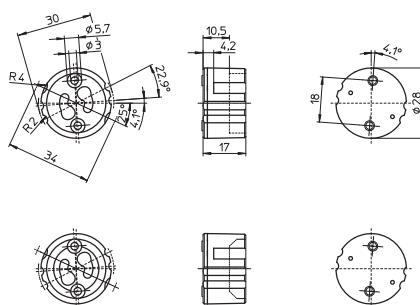

Cover caps for lampholders type 315/317

Material: PBT GF

Front fixing holes for self-tapping

screws acc. to ISO 1481/7049-ST2.9-C/F

Cord grip: twist and block (for single-core leads)

Rear lead exit: max. Ø 2.5 mm

Weight: 6.9 g, unit: 500 pcs.

Type: 97765

Ref. No.: 536164 black

Ref. No.: 543615 grey

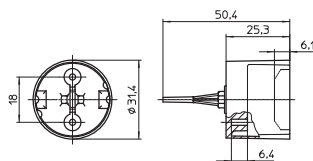

GU/GZ10 lampholder set

For luminaires of protection class II

Casing lampholder: steatite, cover plate: PPS

T240, nominal value: 2/250

Cover cap with cord grip: PBT GF

Leads: Cu, stranded conductors

0.5 mm², double FEP-insulation, length: 150 mm

Weight: 25 g, unit: 500 pcs.

Type: 31760

Ref. No. 554662

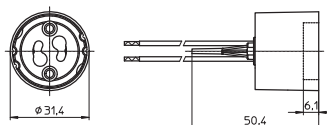

R7s Ceramic Lampholders

For mains voltage halogen incandescent lamps

The luminaire design must ensure protection from electric shock as well as sufficient creepage distances and clearances from live parts on the back of lampholder.

If the central hole on the bracket is used for fixing there must be a support within the luminaire to ensure that the bracket cannot be deformed.

Partly enclosed R7s lampholder

Casing: ceramic, T350

Contact pin: Cu, silver bulb

Nominal rating: 8/250

Leads: Cu nickel-plated, stranded conductors

0.75 mm², PTFE-insulation, length: 200 mm

With fixing screw M4

Weight: 25.4 g, unit: 400 pcs.

Type: 32300

Ref. No.: 100912

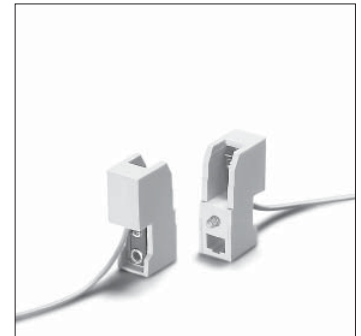
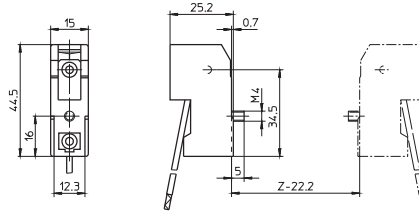

Partly enclosed R7s lampholder

Casing: ceramic, T350

Contact pin: Cu, silver bulb

Nominal rating: 8/250

Leads: Cu nickel-plated, stranded conductors

0.75 mm², PTFE-insulation, length: 200 mm

Oblong holes for screws M3/M4

Central hole for screw M4

Weight: 59.3 g, unit: 200 pcs.

Type: 32390 contact distance: 74.9 mm

Ref. No.: 107213

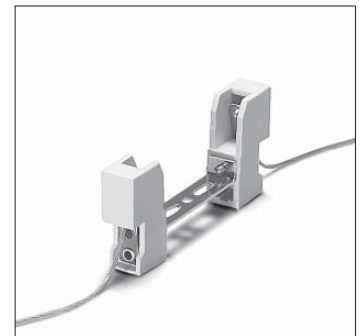
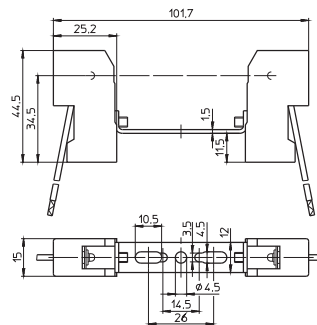

Partly enclosed R7s lampholder

Casing: ceramic, T350

Contact pin: Cu, silver bulb

Nominal rating: 8/250

Leads: Cu nickel-plated, stranded conductors

0.75 mm², PTFE-insulation, length: 200 mm

Oblong holes for screws M3/M4

Central hole for screw M4

Weight: 61 g, unit: 200 pcs.

Type: 32391 contact distance: 74.9 mm

Ref. No.: 107214

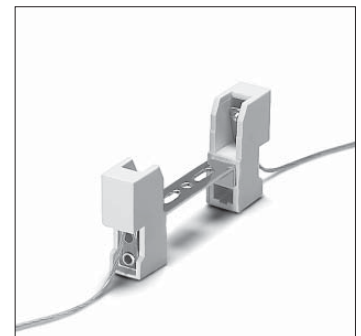
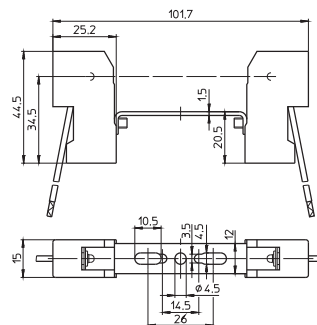

Partly enclosed R7s lampholder

Casing: ceramic, T350

Contact pin: Cu, silver bulb

Nominal rating: 8/250

Leads: Cu nickel-plated, stranded conductors

0.75 mm², PTFE-insulation, length: 200 mm

Oblong holes for screws M3/M4

Central hole for screw M4

Weight: 61.3 g, unit: 200 pcs.

Type: 32395 contact distance: 74.9 mm

Ref. No.: 107215

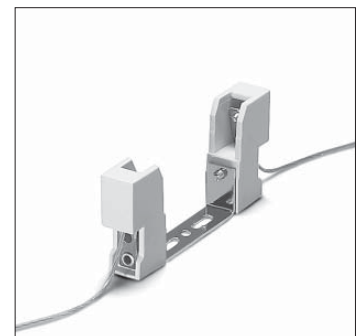
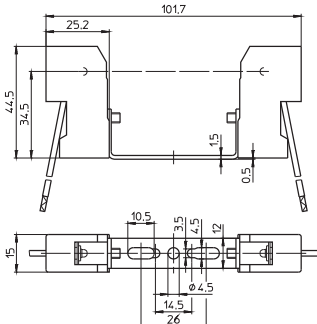

1

2

3

4

5

6

7

8

9

10

Lampholders for Halogen Incandescent Lamps

Partly enclosed R7s lampholder

Casing: ceramic, T350

Contact pin: Cu, silver bulb

Nominal rating: 8/250

Leads: Cu nickel-plated, stranded conductors

0.75 mm², PTFE-insulation, length: 200 mm

Oblong holes for screws M4

Central hole for screw M4

Weight: 64.9 g, unit: 200 pcs.

Type: 32310 contact distance: 114.2 mm

Ref. No.: 107195

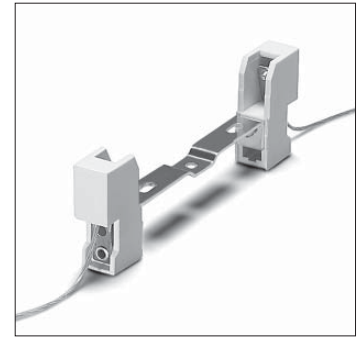
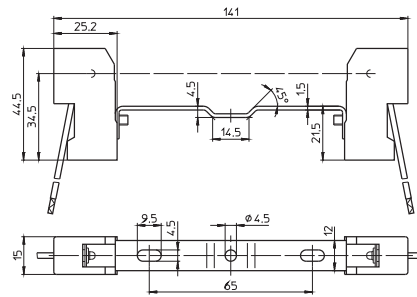

Partly enclosed R7s lampholder

Casing: ceramic, T350

Contact pin: Cu, silver bulb

Nominal rating: 8/250

Leads: Cu nickel-plated, stranded conductors

0.75 mm², PTFE-insulation, length: 200 mm

Oblong holes for screws M4

Central threaded bush M4

Weight: 66.5 g, unit: 200 pcs.

Type: 32320 contact distance: 114.2 mm

Ref. No.: 107194

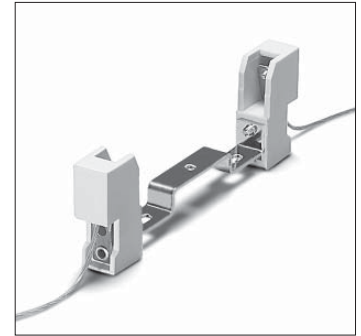
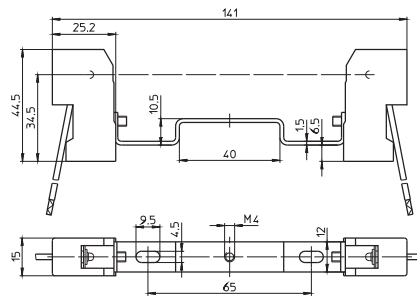

Partly enclosed R7s lampholder

Casing: ceramic, T350

Contact pin: Cu, silver bulb

Nominal rating: 8/250

Leads: Cu nickel-plated, stranded conductors

0.75 mm², PTFE-insulation, length: 200 mm

Oblong holes for screws M4

Central hole for screw M4

Weight: 65.4 g, unit: 200 pcs.

Type: 32340 contact distance: 114.2 mm

Ref. No.: 107193

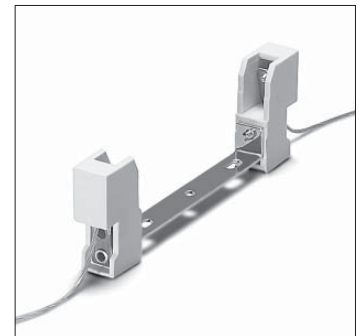
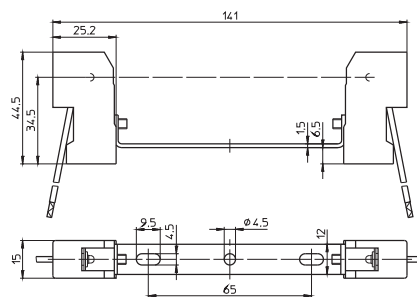

Partly enclosed R7s lampholder

Casing: ceramic, T350

Contact pin: Cu, silver bulb

Nominal rating: 8/250

Leads: Cu nickel-plated, stranded conductors

0.75 mm², PTFE-insulation, length: 200 mm

Oblong holes for screws M4

Central hole for screw M5

Weight: 66.7 g, unit: 200 pcs.

Type: 32360 contact distance: 114.2 mm

Ref. No.: 107192

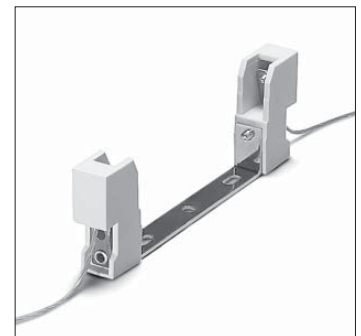
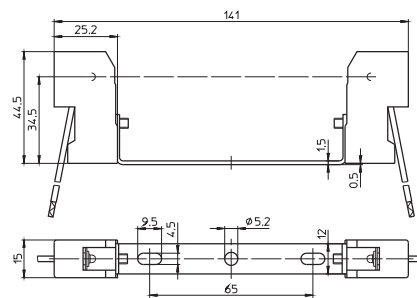

Partly enclosed R7s lampholder

Casing: ceramic, T350

Contact pin: Cu, silver bulb

Nominal rating: 8/250

Leads: Cu nickel-plated, stranded conductors

0.75 mm², PTFE-insulation, length: 200 mm

Oblong holes for screws M4

Central hole for screw M5

Weight: 71.3 g, unit: 200 pcs.

Type: 32380 contact distance: 114.2 mm

Ref. No.: 109497

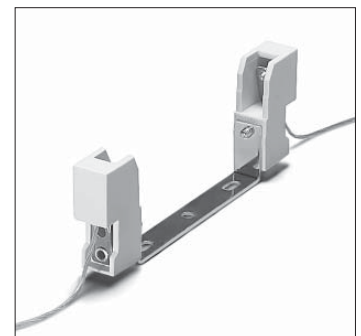
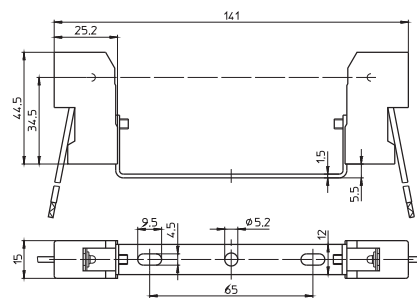

Lampholders for Halogen Incandescent Lamps

Protection cap for R7s lampholders
 For push-fit onto lampholders type 323
 Protection against electrical shock
 on the rear side of the lampholder
 Lampholder with assembled protection cap on request
 Material: LCP, natural
 Weight: 0.7 g, unit: 1000 pcs.
 Type: 97528
Ref. No.: 507592

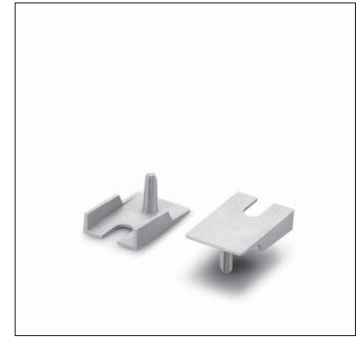
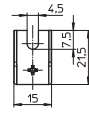

1

2

3

4

R7s Metal Lampholders

For mains voltage halogen incandescent lamps

R7s lampholder
 Casing: Al, T300, contact pin: Ni
 Nominal rating: 10/250
 Lead: Cu nickel-plated, stranded conductors
 0.75 mm², PTFE-insulation, length: 300 mm
 Fixing flange
 Fixing holes for screws M4
 Weight: 21 g, unit: 50 pcs.
 Type: 30023
Ref. No.: 100616

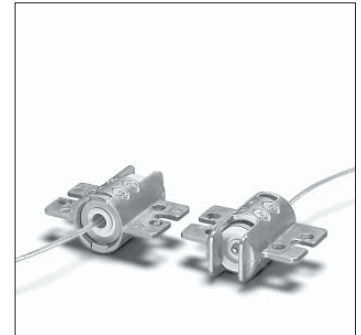
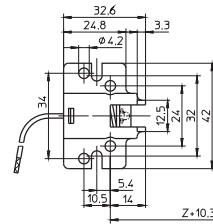
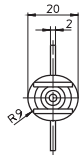

5

6

R7s lampholder
 Casing: Al, T300, contact pin: Cu, silver bulb
 Nominal rating: 10/250
 Lead: Cu nickel-plated, stranded conductors
 1 mm², PTFE-insulation, length: 300 mm
 Fixing flange
 Fixing holes for screws M3
 Weight: 15.7 g, unit: 1000 pcs.
 Type: 30523
Ref. No.: 100710

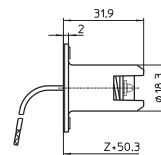
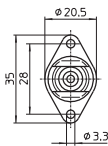

7

8

R7s lampholder
 Casing: Al, T300, contact pin: Cu, silver bulb
 Nominal rating: 10/250
 Lead: Cu nickel-plated, stranded conductors
 1 mm², PTFE-insulation, length: 350 mm
 Fixing bracket
 Fixing holes for screws M4
 Weight: 24.8 g, unit: 500 pcs.
 Type: 30550
Ref. No.: 100720

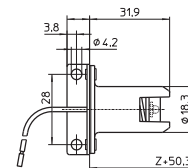
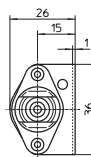

9

10

Connection Boxes

For connecting downlights in false ceilings according to standards
The luminaire manufacturer is responsible for the right choice of accessories.

Application examples for connection box

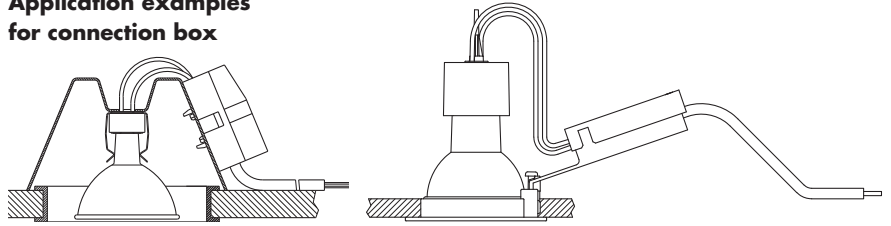

Connection box
Material: PC, black
Split pins for wall thickness 0.5–1.5 mm
With integrated 2-pole terminal block and contact bushings: 2.5 mm²
With cord grip
Weight: 18 g, unit: 500 pcs.
Type: 85007
Ref. No.: 108940

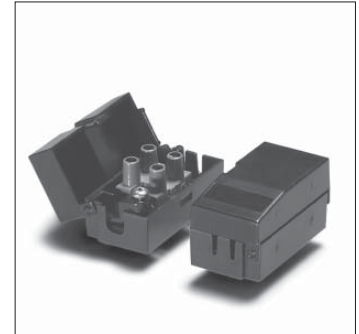
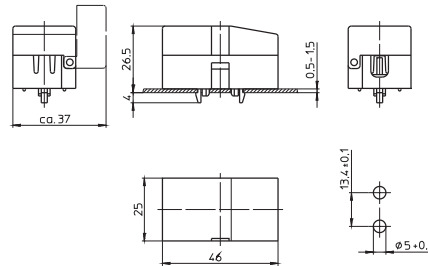

Connection boxes
Material: PA, black
With integrated 2-pole terminal block for leads with cross-section: 0.5–2.5 mm²
Cord grip on primary side for leads H03VV-F/H05VV-F (Ø 5–7 mm) and single-core Ø 3–7 mm
Cord grip on secondary side for single-core Teflon leads up to Ø 3 mm and single-core PVC leads up to Ø 2.2 mm
Weight: 21.8/20.1 g, unit: 500 pcs.
Type: 85011/85012 plastic bracket with locking screw
Ref. No.: 543048 12 V
Ref. No.: 543049 230 V
Type: 85013/85014 for fixing screw
Ref. No.: 543053 12 V
Ref. No.: 543054 230 V

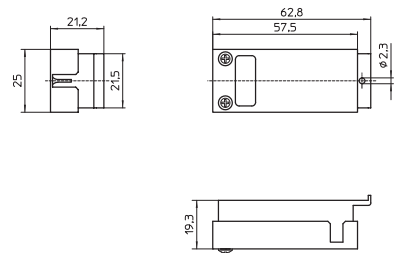
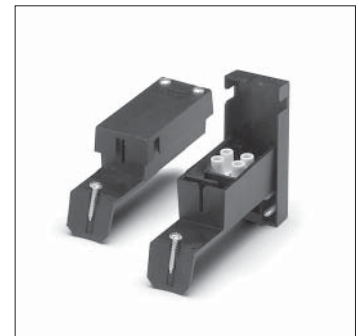
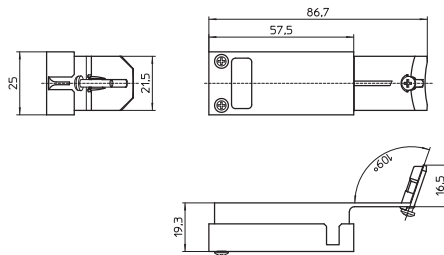

Connection boxes
With plastic bracket with locking screw
Material: PA, black
With integrated 3-pole terminal block for leads with cross-section: 0.75–4 mm²
Cord grip on primary side for leads Ø 2.5–11 mm
Cord grip on secondary side for single-core Teflon leads up to Ø 1.8 mm and single-core PVC leads up to Ø 2.2 mm
Weight: 28.7 g, unit: 500 pcs.
Type: 85015/85016
Ref. No.: 543058 12 V
Ref. No.: 543059 230 V

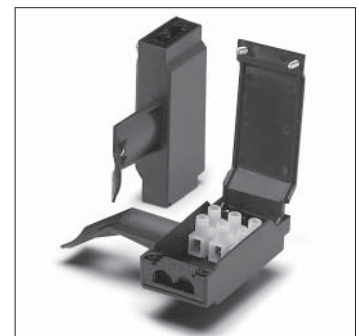
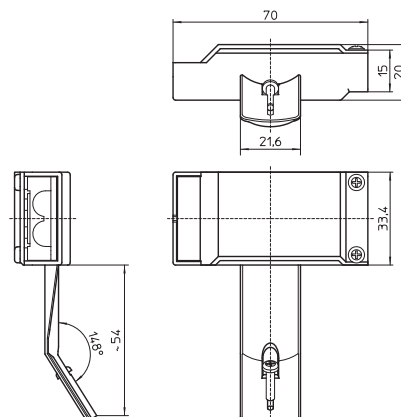

Connectors

Modular system for various assembly options
Connectors can be delivered pre-assembled
with lampholder and lead assemblies

Male and female plug
Nominal rating: 7/600
For cable: 0.3–0.9 mm²
For crimping on the end of lead
Material: brass, tinned
Weight: 0.1 g, unit: 5000 pcs.

Type: 93088 male plug

Ref. No.: 505251

Type: 93089 female plug

Ref. No.: 506807

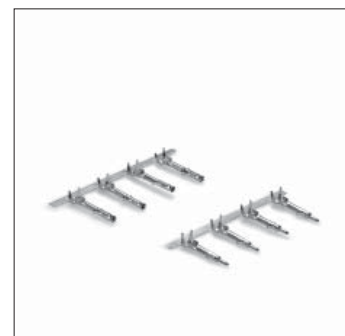
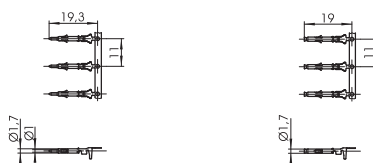

Male and female casing
For male and female plug
For push-fit assembly
Material: PA, natural
Weight: 0.8/1 g, unit: 2500 pcs.

Type: 97355 male casing

Ref. No.: 509295 UL94V-0

Ref. No.: 508562 UL94V-2

Type: 97356 female casing

Ref. No.: 509296 UL94V-0

Ref. No.: 508563 UL94V-2



1

2

3

4

5

6

7

8

9

10

LAMPHOLDERS MADE OF THERMO- PLASTICS, METAL AND PORCELAIN



LAMPHOLDERS FOR GENERAL-SERVICE INCANDESCENT

The general-service light bulb owes its name to its bulbous shape, which has remained almost unchanged to this day. The tungsten filament contained within the bulb's glass shell, in which there used to be a vacuum but which is nowadays more usually filled with an inert gas, begins to glow as electricity is passed through it. Despite the considerable technical progress that has been made, the typical disadvantages associated with light bulbs still remain. For instance, incandescent lamps mainly radiate heat with no more than 5–10% light output and have a service life of approx. 1000 operating hours.

As a result of energy-efficiency regulations in the various regions of the world, the use of all-purpose incandescent lamps has been limited or even banned. Nonetheless, thanks to the many different shapes and surfaces of lamp bulbs, all-purpose incandescent lamps still have a firm place in decorative residential lighting applications and are often an important feature of luminaire designs. Retrofit lamps that comply with energy-efficiency regulations are increasingly being used as a replacement for all-purpose incandescent lamps and use the same lampholder systems found with E12/E14, E26/E27, E39/E40, B15d and B22d bases.

VS lampholders for general-service incandescent and retrofit lamps

Depending on the operating conditions, lampholders can be made of thermoplastics, metal or porcelain. Metal lampholders are most often used for high-grade decorative luminaires. In accordance with protection class I, metal lampholders must be included in the measures taken to earth the luminaire.

Due to their heat resistance, Edison lampholders made of porcelain are frequently used for higher-output lamps. Classic lampholder materials like metal and porcelain are increasingly being displaced by modern thermoplastics.



E14 lampholders

- E14 thermoplastic lampholders, one-piece and cover caps
- E14 thermoplastic lampholders, three-piece
- E14 metal lampholders, three-piece
- E14 thermoplastic rocker switch lampholders

E27 lampholders

- E27 thermoplastic lampholders, one-piece and cover caps
- E27 renovation kit lampholders
- E27 thermoplastic lampholders, three-piece
- E27 porcelain lampholders
- E27 metal lampholders, three-piece
- E27 thermoplastic pull-switch lampholders
- E27 metal pull-switch lampholders
- E27 thermoplastic rocker switch lampholders
- E27 festoon lampholders

B22d lampholders, accessories**Accessories for E14, E27 and B22d lampholders****E40 porcelain lampholders****Technical details for incandescent lamps**

- General technical details
- Glossary

280–288

- 280–284
- 285–287
- 287–288
- 288

289–305

- 289–293
- 294
- 295–297
- 298–299
- 300
- 301–302
- 302–303
- 303–304
- 304–305

305–306**307–312****313****314–327**

- 348–356
- 357–359

1

2

3

4

5

6

7

8

9

10

E14 Thermoplastic Lampholders, One-piece

For incandescent lamps with base E14

E14 lampholders with temperature marking

T180 on request.

Brass-finished versions are available on request.

E14 lampholders, for cover caps

Plain casing

Casing: PET GF, T210, nominal rating: 2/250

Push-in twin terminals: 0.5–1.5 mm²

Rear fixing holes for self-tapping screws
acc. to ISO 1481/7049-ST2.9-C/F

Weight: 11.3/11.4 g, unit: 1000 pcs.

Type: 64001

Ref. No.: 109384 white

Ref. No.: 109383 black

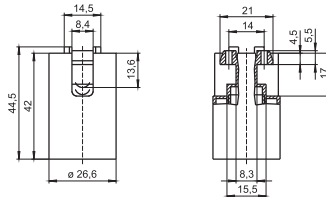

E14 lampholders, for cover caps

External thread 28x2 IEC 60399

Casing: PET GF, T210, nominal rating: 2/250

Push-in twin terminals: 0.5–1.5 mm²

Rear fixing holes for self-tapping screws
acc. to ISO 1481/7049-ST2.9-C/F

Weight: 12.5/12.2 g, unit: 1000 pcs.

Type: 64101

Ref. No.: 109387 white

Ref. No.: 109386 black

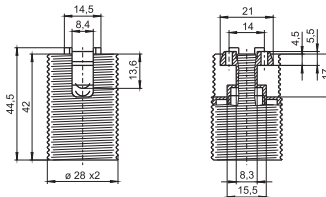

E14 lampholders, for cover caps

External thread 28x2 IEC 60399, with flange

Casing: PET GF, T210, nominal rating: 2/250

Push-in twin terminals: 0.5–1.5 mm²

Rear fixing holes for self-tapping screws
acc. to ISO 1481/7049-ST2.9-C/F

Weight: 12.7 g, unit: 1000 pcs.

Type: 64201

Ref. No.: 503924 white

Ref. No.: 503923 black

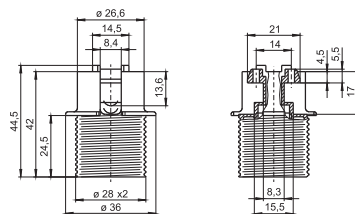

E14 lampholders, for cover caps

Profiled shape, short external thread 28x2 IEC 60399

Casing: PET GF, T210, Nominal rating: 2/250

Push-in twin terminals: 0.5–1.5 mm²

Rear fixing holes for self-tapping screws
acc. to ISO 1481/7049-ST2.9-C/F

Weight: 8.5/8.4 g, unit: 1000 pcs.

Type: 64370

Ref. No.: 546456 white

Ref. No.: 546454 black

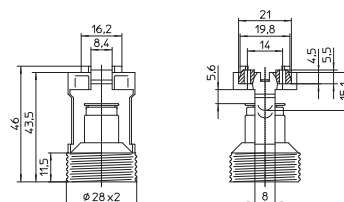

Lampholders for General-service Incandescent

E14 lampholders

Profiled shape, short external thread 28x2 IEC 60399

Casing: PET GF, T210, nominal rating: 2/250

Push-in twin terminals: 0.5–1.5 mm²

For clipping-in

Weight: 6.6/6.8 g, unit: 1000 pcs.

Type: 64360

Ref. No.: 506247 white

Ref. No.: 506249 black

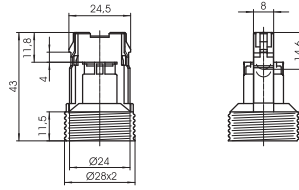

1

2

E14 lampholders

Profiled shape, nominal rating: 2/250

Push-in twin terminals: 0.5–1.5 mm²

Lateral push-fit foot for cut-out 10x20 mm for wall thickness 0.6–1.3 mm

Tilt of lamp axis: 6°

For cover cap 503579

Weight: 9.1/9.2 g, unit: 1000 pcs.

Type: 64307

Ref. No.: 108983 PBT GF, white, T180

Ref. No.: 509263 PET GF, natural, T210

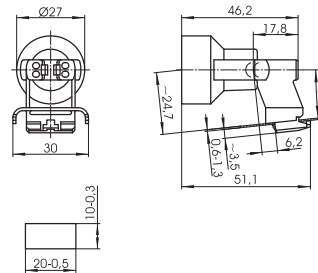

3

4

E14 lampholder

Profiled shape

Casing: PET GF, white, T210

Nominal rating: 2/250

Push-in twin terminals: 0.5–1.5 mm²

For insertion, clipping-in or bayonet fixing

for plastic cut-out: Ø 27.5 mm

with wall thickness: 2.5 mm

Weight: 7.1 g, unit: 1000 pcs.

Type: 64308

Ref. No.: 533820

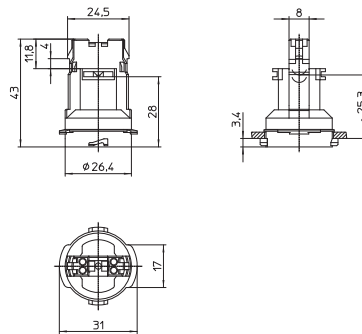

5

6

E14 lampholder

Profiled shape

Casing: PET GF, white, T250

Nominal rating: 2/250

Push-in twin terminals: 0.5–1.5 mm²

For insertion: clipping-in for

a profiled hole with wall thickness 0.6–0.7 mm

Weight: 9 g, packaging unit: 1000 pcs.

Type: 64314

Ref. No.: 564135

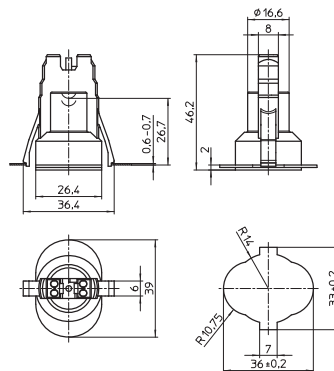

7

8

9

10

Cover Caps

For E14 thermoplastic lampholders, one-piece

Brass-finished versions are available on request.

Cover cap for lampholders type 64307

For luminaires of protection class II

Material: PP, white

Weight: 2.4 g, unit: 1000 pcs.

Type: 97322

Ref. No.: 503579

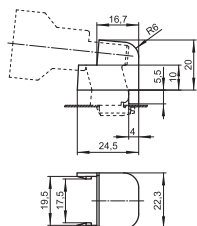

Cover caps

Material: PA GF

Female nipple: M10x1

Weight: 7.6/8.8 g, unit: 1000 pcs.

Type: 85075

Ref. No.: 109110 white

Ref. No.: 109112 black

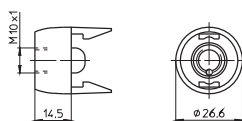

Cover caps

Material: PA GF

Moulded thread: M10x1

Rotation stop: external

Weight: 2.7 g, unit: 1000 pcs.

Type: 97636

Ref. No.: 109676 white

Ref. No.: 109677 black

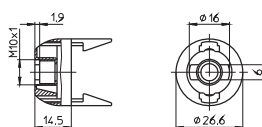

Cover caps

Material: PA GF

Moulded thread: M10x1

Rotation stop: external

With locking screw

Weight: 3 g, unit: 1000 pcs.

Type: 85076

Ref. No.: 400818 white

Ref. No.: 400817 black

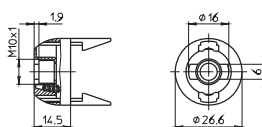

Cover caps

Height: 19 mm

Material: PA GF

Moulded thread: M10x1

Rotation stop: external

Weight: 3.2/3.1 g, unit: 1000 pcs.

Type: 97705

Ref. No.: 520733 white

Ref. No.: 520734 black

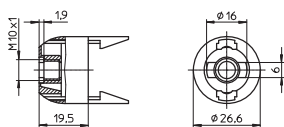

Lampholders for General-service Incandescent

Cover caps
 Height: 19 mm
 Material: PA GF
 Moulded thread: M10x1
 Rotation stop: external
 With locking screw
 Weight: 3.6/3.5 g, unit: 1000 pcs.
 Type: 85074

Ref. No.: 520735 white
Ref. No.: 520736 black

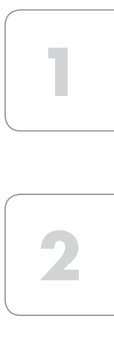
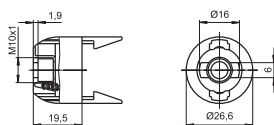

Cover caps
 Material: PA GF
 Round hole: Ø 10.5 mm
 Rotation stop: internal and external
 Weight: 4.3 g, unit: 1000 pcs.
 Type: 97666

Ref. No.: 109119 white
Ref. No.: 109120 black

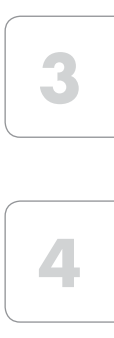
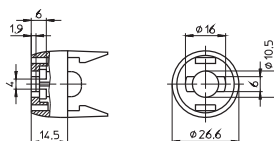

Cover caps
 Material: PA GF
 Profiled hole: Ø 10.5x8.6 mm
 Fixing holes for screws M3
 Weight: 4.4/4.3 g, unit: 1000 pcs.
 Type: 97635

Ref. No.: 109122 white
Ref. No.: 109123 black

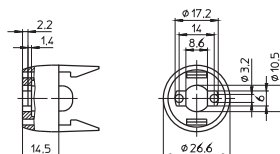

Cover cap
 Material: PA GF
 Profiled hole: Ø 10.4 mm
 Rotation stop: internal and external
 Weight: 4 g, unit: 1000 pcs.
 Type: 97697

Ref. No.: 109126 black

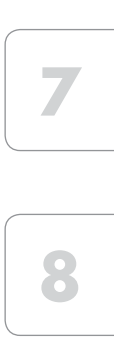
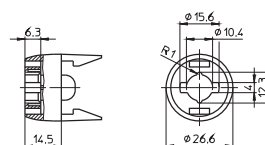

Cover caps
 Height: 19 mm
 Material: PA GF
 Profiled hole: Ø 10.4 mm
 Rotation stop: internal and external
 Weight: 2.7 g, unit: 1000 pcs.
 Type: 97708

Ref. No.: 520759 white
Ref. No.: 520760 black

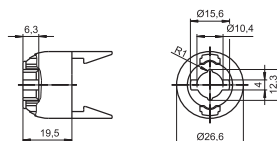

Lampholders for General-service Incandescent

Cover caps
 With peg
 With integrated cord grip
 For leads H03VVH2-F 2X0.75
 Material: PA GF
 Weight: 4.2/4.3 g, unit: 1000 pcs.
 Type: 97000

Ref. No.: 503457 white

Ref. No.: 503458 black

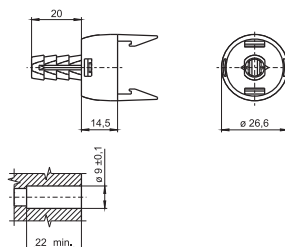

Cover cap
 With male nipple: M10x1
 With rotation stop
 With integrated cord grip
 For leads H03VVH2-F 2X0.75
 Material: PA GF, white
 Weight: 4.1 g, unit: 1000 pcs.
 Type: 97037

Ref. No.: 508067

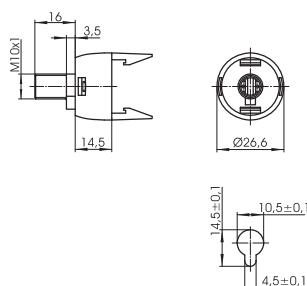

Cover cap
 External thread 28x2 IEC 60399
 With integrated cord grip
 For leads H03VVH2-F 2X0.75
 Material: PA GF, natural
 Weight: 5.5 g, unit: 1000 pcs.
 Type: 97427

Ref. No.: 509340

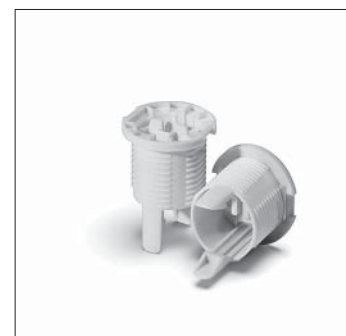
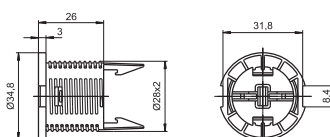

Cover cap
 Lateral push-fit foot for cut-out 10x20 mm
 For luminaires of protection class II
 Material: PA GF, white
 Weight: 4.3 g, unit: 1000 pcs.
 Type: 97745

Ref. No.: 546006

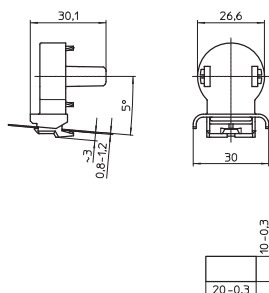

Cover cap
 With central positioning stud
 Material: PA GF
 Fixing holes for countersunk screws Ø 3 mm
 Weight: 3 g, unit: 1000 pcs.
 Type: 91522

Ref. No.: 535357

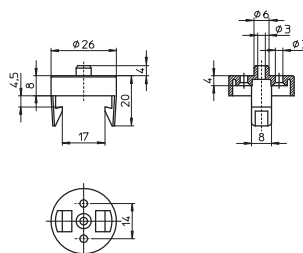

E14 Thermoplastic Lampholders, Three-piece

For incandescent lamps with base E14

Nominal rating: 2/250

Temperature marking: T190

Brass-finished versions are available on request.

Inserts

Material: PET GF, black

Casing lock

Weight: 3.9/3.2 g, unit: 1000 pcs.

Type: 81095 screw terminals: 0.5–2.5 mm²

Ref. No.: 103424

Type: 81096 push-in twin terminals: 0.5–1.5 mm²

Ref. No.: 107716



Plain casings

Material: PET GF

Weight: 9/8.5 g, unit: 1000 pcs.

Type: 81093

Ref. No.: 103415 white

Ref. No.: 103414 black

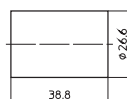

Threaded casings 28x2 IEC 60399

Material: PET GF

Weight: 9.8/9.6 g, unit: 1000 pcs.

Type: 81109

Ref. No.: 103431 white

Ref. No.: 103430 black

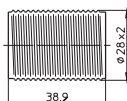

Threaded casings 28x2 IEC 60399

With flange

Material: PET GF

Weight: 10.6/10.4 g, unit: 1000 pcs.

Type: 81120

Ref. No.: 103443 white

Ref. No.: 103442 black

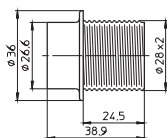

1



2

3



4

5



6

7



8

9

10

Lampholders for General-service Incandescent

Caps

Material: PA GF

Female nipple: M10x1

Height: 13.7 mm

Weight: 6.9/7.2 g, unit: 1000 pcs.

Type: 81002

Ref. No.: 109102 white

Ref. No.: 109103 black

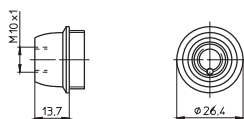

Caps

Material: PA GF

Female nipple: M10x1

Height: 18.7 mm

Weight: 7/7.3 g, unit: 1000 pcs.

Type: 81024

Ref. No.: 109805 white

Ref. No.: 109145 black

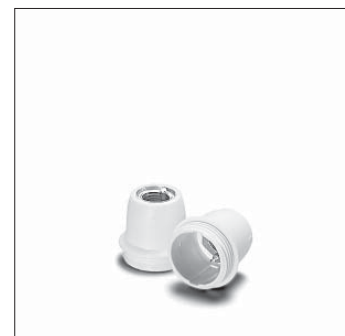
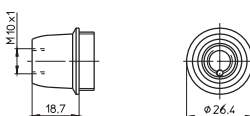

Caps

Material: PA GF

Moulded thread: M10x1

Rotation stop: external

Height: 13.7 mm

Weight: 3.3/3.7 g, unit: 1000 pcs.

Type: 96159

Ref. No.: 109095 white

Ref. No.: 109084 black

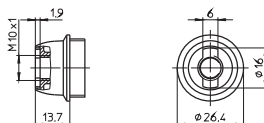

Caps

Material: PA GF

Moulded thread: M10x1

Rotation stop: external

Height: 18.7 mm

Weight: 3.6/3.9 g, unit: 1000 pcs.

Type: 96211

Ref. No.: 109149 white

Ref. No.: 109150 black

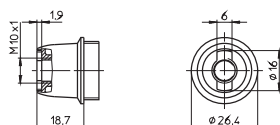

Caps

Material: PA GF

Moulded thread: M10x1

Rotation stop: external

With locking screw

Height: 13.7 mm

Weight: 3.7/4 g, unit: 1000 pcs.

Type: 81130

Ref. No.: 109041 white

Ref. No.: 109054 black

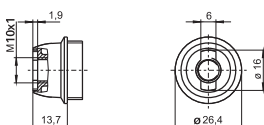

Lampholders for General-service Incandescent

Caps

Material: PA GF

Moulded thread: M10x1

Rotation stop: external

With locking screw

Height: 18.7 mm

Weight: 3.9/4.3 g, unit: 1000 pcs.

Type: 81132

Ref. No.: 109152 white

Ref. No.: 109153 black

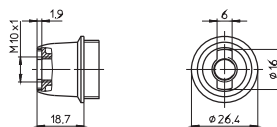

1

2

Caps

Material: PA GF

Round hole: Ø 10.5 mm

Rotation stop: internal

Height: 13.7 mm

Weight: 3.3 g, unit: 1000 pcs.

Type: 96004

Ref. No.: 508352 white

Ref. No.: 508353 black

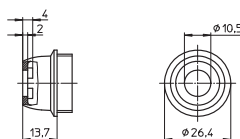

3

4

E14 Metal Lampholders, Three-piece

For incandescent lamps with base E14

Nominal rating: 2/250

Temperature marking: T190/T240

Type: 513 plain casing

Type: 514 threaded casing 28x2

Insert

Material: porcelain, white

Casing lock

Screw terminals: 0.5–2.5 mm²

Weight: 10.3 g, unit: 500 pcs.

Type: 83142

Ref. No.: 550375



5

6

Plain casings

Material: zinc-coated polished steel

Weight: 14.3/14.2/18.3/18.2 g

Unit: 500 pcs.

Type: 81019 insulating threaded ring: duroplastic, T190

Ref. No.: 103359 chrome-finish

Ref. No.: 103360 brass-finish

Type: 81018 insulating threaded ring: steatite, T240

Ref. No.: 507049 chrome-finish

Ref. No.: 507050 brass-finish

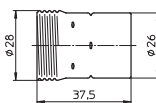

7

8



9

10

Lampholders for General-service Incandescent

Threaded casings 28x2 IEC 60399

Material: zinc-coated polished steel

Weight: 14.4/14.4/18.9/18.9 g

Unit: 500 pcs.

Type: 81022 insulating threaded ring: duroplastic, T190

Ref. No.: 103365 chrome-finish

Ref. No.: 103366 brass-finish

Type: 81017 insulating threaded ring: steatite, T240

Ref. No.: 507052 chrome-finish

Ref. No.: 507053 brass-finish

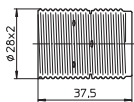

Caps

Material: zinc-coated polished steel

Female nipple: M10x1

Weight: 7.2/7.1/7.9/7.8 g

Unit: 500 pcs.

Type: 80006

Ref. No.: 102946 chrome-finish

Ref. No.: 102947 brass-finish

Type: 80003 with earth terminal

Ref. No.: 102938 chrome-finish

Ref. No.: 102939 brass-finish

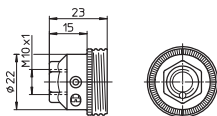
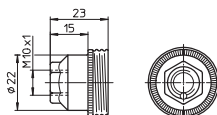

E14 Thermoplastic Rocker Switch Lampholders

For incandescent lamps with base E14

Nominal rating: 2/250

Temperature marking: T160

Suitable casings see page 293:

Type: 81093 plain casing

Type: 81109 threaded casing 28x2

Type: 81120 threaded casing 28x2, with flange

Inserts with switch

Material: PET GF

Screw terminals: 0.5–2.5 mm²

Weight: 7.9 g, unit: 1000 pcs.

Type: 83141

Ref. No.: 537087 switch, white

Ref. No.: 537088 switch, black

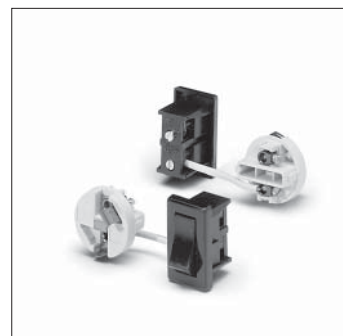
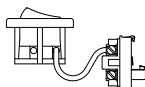

Caps

Material: PET GF

Moulded thread: M10x1

with locking screw

Weight: 9.9 g, unit: 1000 pcs.

Type: 81100

Ref. No.: 537079 white

Ref. No.: 537080 black

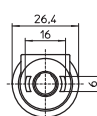
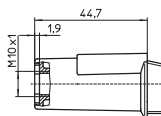

E27 Thermoplastic Lampholders, One-piece

For incandescent lamps with base E27

E27 lampholders with temperature marking
T180 on request.
Brass-finished versions are available on request.

E27 lampholders, for cover caps
Plain casing
Casing: PET GF, T210
Nominal rating: 4/250
Push-in twin terminals: 0.5–2.5 mm²
Fixing holes for screws M4
Weight: 17.4 g, unit: 500 pcs.
Type: 64401
Ref. No.: 108936 white
Ref. No.: 500810 black

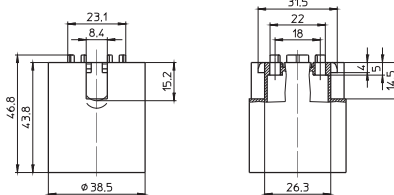

E27 lampholders, for cover caps
External thread 40x2.5 IEC 60399
Casing: PET GF, T210
Nominal rating: 4/250
Push-in twin terminals: 0.5–2.5 mm²
Fixing holes for screws M4
Weight: 19.1/18.8 g, unit: 500 pcs.
Type: 64501
Ref. No.: 108965 white
Ref. No.: 109429 black

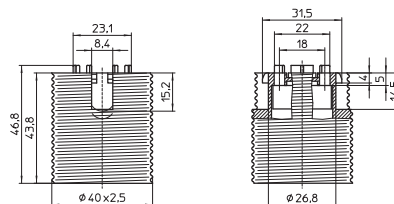

E27 lampholders, for cover caps
External thread 40x2.5 IEC 60399, with flange
Casing: PET GF, T210
Nominal rating: 4/250
Push-in twin terminals: 0.5–2.5 mm²
Fixing holes for screws M4
Weight: 21.4 g, unit: 500 pcs.
Type: 64601
Ref. No.: 501358 white
Ref. No.: 501356 black

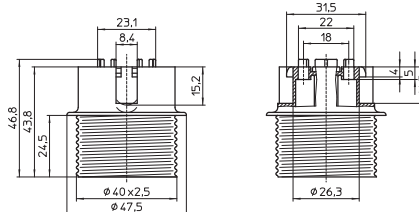

E27 lampholders, for cover caps
Profiled shape, external thread 40x2.5 IEC 60399
Casing: PET GF, T210, nominal rating: 4/250
Push-in twin terminals: 0.5–2.5 mm²
Fixing holes for screws M3
Rear fixing holes for self-tapping screws
acc. to ISO 1481/7049-ST3.9-C/F
Weight: 14.8/14.9 g, unit: 500 pcs.
Type: 64719
Ref. No.: 504303 white
Ref. No.: 504302 black

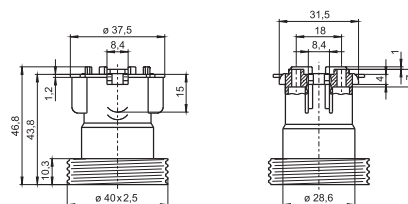

1

2

3

4

5

6

7

8

9

10

Lampholders for General-service Incandescent

E27 lampholders, for cover caps
 Profiled shape, external thread 40x2.5 IEC 60399
 Casing: PET GF, T210, nominal rating: 4/250
 Push-in twin terminals: 0.5–2.5 mm²
 Fixing holes for screws M3
 Rear fixing holes for self-tapping screws
 acc. to ISO 1481/7049-ST3.9-C/F
 Weight: 11.4/11.3 g, unit: 500 pcs.
 Type: 64775

Ref. No.: 506255 white
Ref. No.: 506257 black

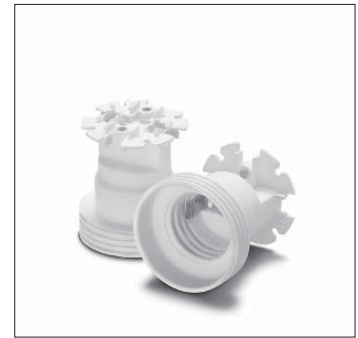
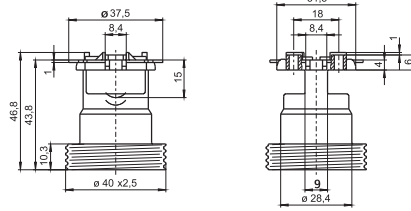

E27 lampholders
 Profiled shape, plain, nominal rating: 4/250
 Screw terminals: 0.5–2.5 mm²
 Fixing holes for screws M3
 Rear fixing holes for self-tapping screws
 acc. to ISO 1481/7049-ST3.9-C/F
 Weight: 11.7/11.5/13 g, unit: 500 pcs.
 Type: 64785

Ref. No.: 506263 PET GF, white, T210
Ref. No.: 506265 PET GF, black, T210
Ref. No.: 506267 LCP, natural, T270

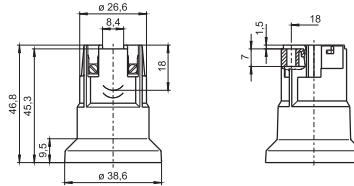

E27 lampholders
 For cover caps type 97545/80023 (see p. 292)
 Profiled shape, plain, nominal rating: 4/250
 Push-in twin terminals: 0.5–2.5 mm²
 Fixing holes for screws M3
 Rear fixing holes for self-tapping screws
 acc. to ISO 1481/7049-ST3.9-C/F
 Weight: 11.5/14.9 g, unit: 500 pcs.
 Type: 64770

Ref. No.: 108953 PET GF, natural, T210
Ref. No.: 109838 LCP, natural, T270

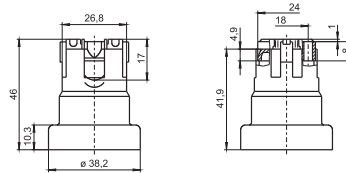

E27 lampholder
 For luminaires of protection class II
 Profiled shape, plain
 Casing: PET GF, white, T210
 Nominal rating: 4/250
 Screw terminals: 0.5–2.5 mm²
 Lateral fixing hole for screw M4
 Tilt of lamp axis: 3°
 Weight: 15.2 g, unit: 500 pcs.
 Type: 64781

Ref. No.: 503041

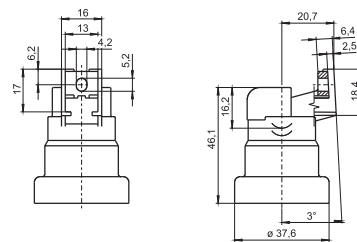

E27 lampholders
 Profiled shape, plain
 Casing: PET GF, T210
 Nominal rating: 4/250
 Push-in twin terminals: 0.5–2.5 mm²
 Lateral fixing hole for screw M4
 Tilt of lamp axis: 3°
 Weight: 13.3 g, unit: 500 pcs.
 Type: 64740

Ref. No.: 108747 white
Ref. No.: 529599 natural

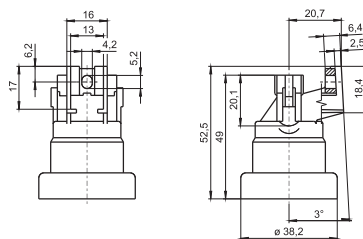

Lampholders for General-service Incandescent

E27 lampholder

Profiled shape, external thread 40x2.5 IEC 60399

Casing: PET GF, natural, T210, nominal rating: 4/250

Push-in twin terminals: 0.5–2.5 mm²

Lateral push-fit foot for cut-out 10x20 mm

Fixing clips for wall thickness 0.4–1 mm

Tilt of lamp axis: 12°

For cover cap 504615 (see below)

Weight: 14.7 g, unit: 500 pcs.

Type: 64741

Ref. No.: 108758

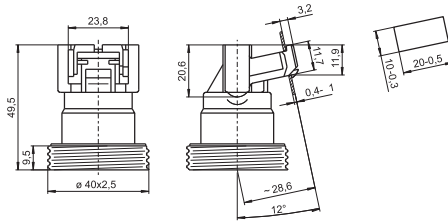

1

2

3

4

Cover Caps

For E27 thermoplastic lampholders, one-piece and for B22d thermoplastic lampholders

Cover cap for lampholder 108758 (see above)

For luminaires of protection class II

Material: PA GF, white

Weight: 2.7 g, unit: 500 pcs.

Type: 97321

Ref. No.: 504615

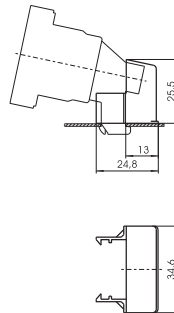

5

6

Protection caps for E27 lampholders with bracket with earth connection 400772 (s. p. 309)

For lampholder type 64770/64785 (s. p. 290)

For luminaires of protection class II

Material: PA GF, natural

Weight: 4.8 g, unit: 500 pcs.

Type: 97497

Ref. No.: 526886

Type: 97498 fixing hole: Ø 10 mm

Ref. No.: 529464

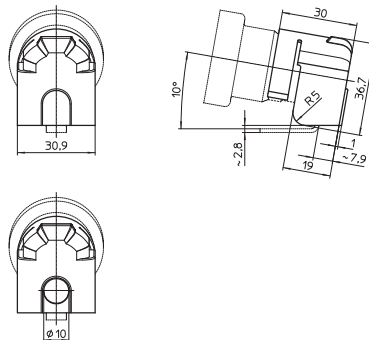

7

8

Cover caps

Material: PA GF

Female nipple: M10x1

Weight: 9.6/9.9 g, unit: 500 pcs.

Type: 85070

Ref. No.: 109077 white

Ref. No.: 109092 black

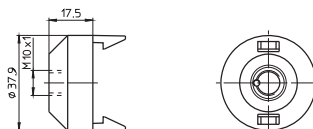

9

10

Lampholders for General-service Incandescent

Cover caps

Material: PA GF

Moulded thread: M10x1

Cross groove for rotation stop: external

Weight: 4.4/4.6 g, unit: 500 pcs.

Type: 97665

Ref. No.: 109679 white

Ref. No.: 109680 black

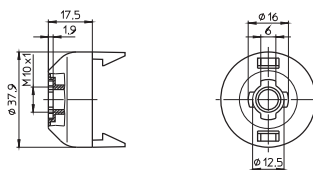

Cover caps

Material: PA GF

Moulded thread: M10x1

Cross groove for rotation stop: external

With lateral hole

Weight: 4.4/4.6 g, unit: 500 pcs.

Type: 97664

Ref. No.: 109795 white

Ref. No.: 109794 black

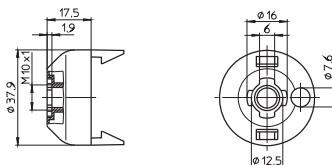

Cover caps

Material: PA GF

Moulded thread: M10x1

Cross groove for rotation stop: external

With locking screw

Weight: 4.7/4.9 g, unit: 500 pcs.

Type: 85077

Ref. No.: 400819 white

Ref. No.: 400820 black

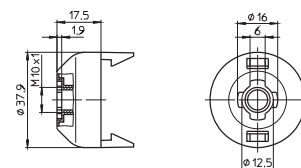

Cover caps

For E27 lampholders type 64770

Material: PA GF, black

Moulded thread: M10x1

Cross groove for rotation stop: external

Weight: 3.1/3.4 g, unit: 500 pcs.

Type: 97545

Ref. No.: 532390

Type: 80023 with locking screw

Ref. No.: 532391

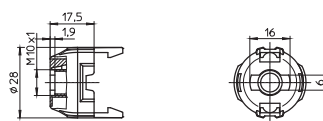

Cover caps

Material: PA GF

Profiled hole: Ø 10.4 mm

Rotation stop: internal and external

Weight: 5.7/5.9 g, unit: 500 pcs.

Type: 97698

Ref. No.: 109560 white

Ref. No.: 109184 black

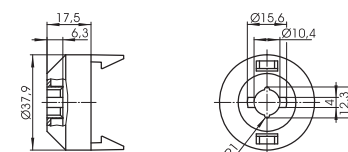

Lampholders for General-service Incandescent

Cover caps

Material: PA GF

Round hole: \varnothing 10.5 mm

Rotation stop: external

Fixing holes for screws M4

Weight: 5.4/5.5 g, unit: 500 pcs.

Type: 97511

Ref. No.: 109045 white

Ref. No.: 109062 black

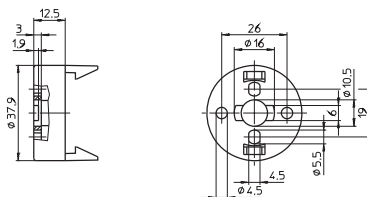

1

2

Cover caps

Conical shape

Material: PA GF

Moulded thread: M10x1

Cross groove for rotation stop: external

Weight: 8.9/8.8 g, unit: 500 pcs.

Type: 97260

Ref. No.: 109555 white

Ref. No.: 109556 black

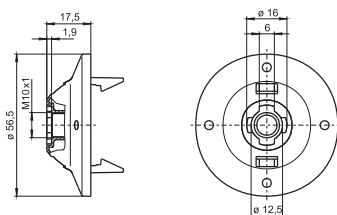

3

4

Cover caps

Conical shape

Material: PA GF

With integrated cord grip

For leads H03VV-F 2X0.5 or

H03VV-F 2X0.75

Weight: 10.6/10.5 g, unit: 500 pcs.

Type: 83282

Ref. No.: 109159 white

Ref. No.: 109462 black

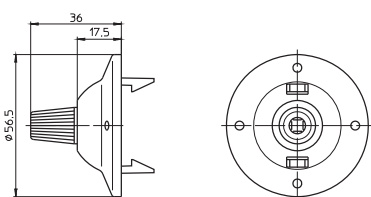

5

6

Cover cap for lampholder 102624 (see p. 299)

With cord grip for self-tapping screws

acc. to ISO 1481/7049-ST2.9-C/F

Cord grip for luminaires of protection class II

Material: PA GF, black

Weight: 12.5/2.2 g, unit: 500 pcs.

Type: 96206 cover cap

Ref. No.: 107178

Type: 96242 cord grip

Ref. No.: 107177

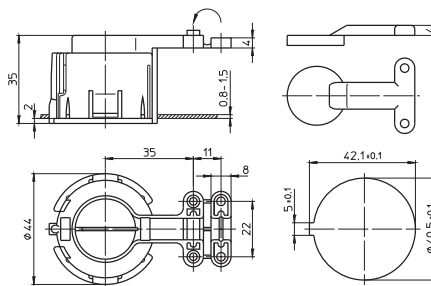

7

8

Cover caps

Material: PA GF

With integrated cord grip

For leads H03VV-F 2X0.5 or

H03VV-F 2X0.75

Weight: 6.6/5.8 g, unit: 500 pcs.

Type: 83283

Ref. No.: 504769 white

Ref. No.: 507075 black

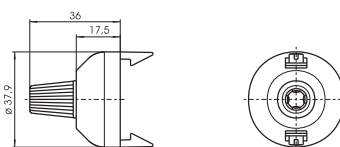

9

10

E27 Renovation Kit Lampholders

For incandescent lamps with base E27

E27 renovation kit lampholders with suspension
Profiled shaped lampholder 64770 – T180
Cover cap with cord grip 532394
Nominal rating: 4/250
Lead: Cu, stranded conductors 0.75 mm²,
double PVC-insulation, length: 150 mm
Weight: 25.8/26.2 g, unit: 150 pcs.
Type: 64770

Ref. No.: 564680 black, with screw terminal
Ref. No.: 564681 black, with push-in terminal

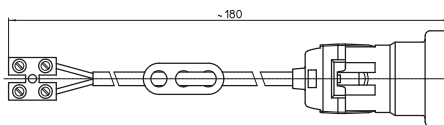

E27 Thermoplastic Lampholders, Three-piece

For incandescent lamps with base E27

Nominal rating: 4/250
 Temperature marking: T190
 Brass-finished versions are available on request.

Inserts

Material: PET GF, black
 Casing lock
 Weight: 5.7/6.1 g, unit: 500 pcs.
 Type: 83285 push-in terminals: 0.5–1.5 mm²
Ref. No.: 103643
 Type: 83011 screw terminals: 0.5–2.5 mm²
Ref. No.: 103520



Plain casings

Material: PET GF
 Weight: 14.5/14.3 g, unit: 500 pcs.
 Type: 83000
Ref. No.: 103468 white
Ref. No.: 103467 black

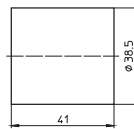

Threaded casings 40x2.5 IEC 60399

Material: PET GF
 Weight: 17/16.1 g, unit: 500 pcs.
 Type: 83002
Ref. No.: 103484 white
Ref. No.: 103483 black

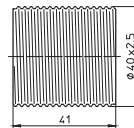

Threaded casings 40x2.5 IEC 60399

With flange
 Material: PET GF
 Weight: 16.7/17 g, unit: 500 pcs.
 Type: 83173
Ref. No.: 103570 white
Ref. No.: 103569 black

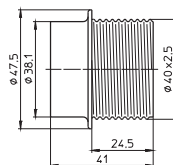

1



2

3



4

5



6

7



8

9

10

Lampholders for General-service Incandescent

Caps

Material: PA GF

Profiled hole: \varnothing 10,5x8,6 mm

Fixing holes for screws M4

Height: 13,8 mm

Weight: 5,6/6 g, unit: 500 pcs.

Type: 96148

Ref. No.: 109188 white

Ref. No.: 109187 black

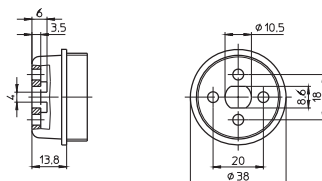

Caps

Material: PA GF

Female nipple: M10x1

Height: 17 mm

Weight: 9,8/10,1 g, unit: 500 pcs.

Type: 83007

Ref. No.: 109052 white

Ref. No.: 109039 black

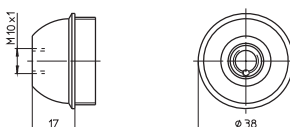

Caps with earth terminal

Material: PA GF

Female nipple: M10x1

Height: 17 mm

Weight: 10,7/11 g, unit: 500 pcs.

Type: 83035

Ref. No.: 109098 white

Ref. No.: 109099 black

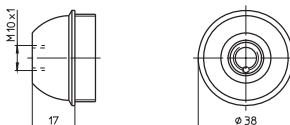

Caps

Material: PA GF

Moulded thread: M10x1

Rotation stop: external

Height: 17 mm

Weight: 6,7/7 g, unit: 500 pcs.

Type: 96147

Ref. No.: 109195 white

Ref. No.: 109196 black

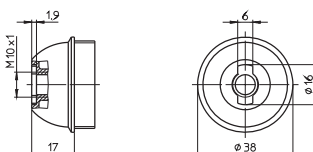

Caps

Material: PA GF

Moulded thread: M10x1

Rotation stop: external

With locking screw

Height: 17 mm

Weight: 7,1/7,3 g, unit: 500 pcs.

Type: 83293

Ref. No.: 109087 white

Ref. No.: 109074 black

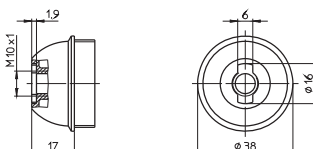

Lampholders for General-service Incandescent

Caps

Material: PA GF

Round hole: \varnothing 10.5 mm

Rotation stop: internal and external

Height: 17 mm

Weight: 5.9/6.6 g, unit: 500 pcs.

Type: 96154

Ref. No.: 109190 white

Ref. No.: 109191 black

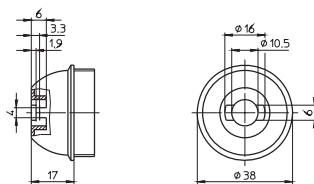

1

2

Caps

Material: PA GF

Profiled hole: \varnothing 10.3 mm

Rotation stop: internal and external

Height: 17 mm

Weight: 5.9/6.6 g, unit: 500 pcs.

Type: 96124

Ref. No.: 109559 white

Ref. No.: 109512 black

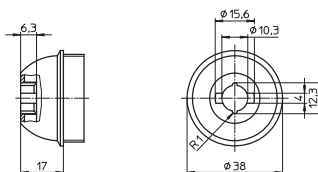

3

4

Caps

Conical shape

Material: PA GF

Female nipple: M10x1

Height: 19.2 mm

Weight: 14.2/15.2 g, unit: 500 pcs.

Type: 83274

Ref. No.: 109081 white

Ref. No.: 109093 black

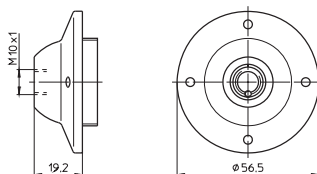

5

6

Caps

Conical shape

Material: PA GF

Round hole: \varnothing 10.5 mm

Rotation stop: internal

Height: 19.2 mm

Weight: 10.4/10.6 g, unit: 500 pcs.

Type: 96172

Ref. No.: 109060 white

Ref. No.: 109044 black

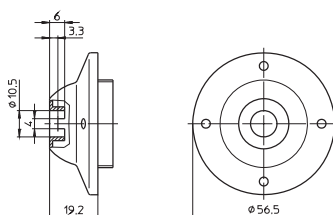

7

8

9

10

E27 Porcelain Lampholders

For incandescent lamps with base E27

E27 lampholders, one-piece
 Material: porcelain, white, T270
 Nominal rating: 4/250/5 kV
 Screw terminals: 0.5–2.5 mm²
 Spring loaded central contact
 Fixing oblong holes for screws M4
 Weight: 60.6 g, unit: 250 pcs.
 Type: 62050

Ref. No.: 102599

Type: 62010 with lamp safety catch (with spring)

Ref. No.: 102577

Type: 62009 with lamp safety catch (with crushing)

Ref. No.: 544605

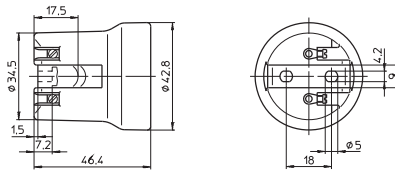

E27 lampholder, one-piece
 Material: porcelain, white, T270
 Nominal rating: 4/250/5 kV
 Screw terminals: 0.5–2.5 mm²
 Spring loaded central contact
 Fixing pillars for screws M3
 Weight: 66.3 g, unit: 250 pcs.
 Type: 62015

Ref. No.: 102582

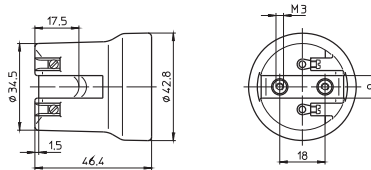

E27 lampholder, one-piece
 Material: porcelain, white, T270
 Nominal rating: 4/250/5 kV
 Screw terminals: 0.5–2.5 mm²
 Spring loaded central contact
 Fixing oblong holes for screws M4
 Weight: 60.5 g, unit: 200 pcs.
 Type: 62070

Ref. No.: 543304

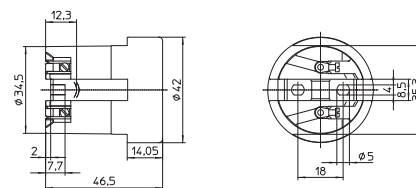

E27 lampholder, one-piece
 Material: porcelain, white, T270
 Nominal rating: 4/250/5 kV
 Screw terminals: 0.5–2.5 mm²
 With lateral fixing flange,
 tilt angle: 15°
 Spring loaded central contact
 Fixing hole for screw M4
 Weight: 67.6 g, unit: 200 pcs.
 Type: 62415

Ref. No.: 543414

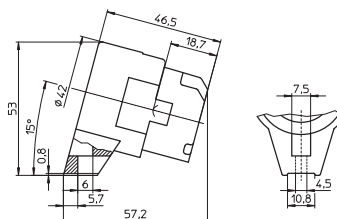

Lampholders for General-service Incandescent

E27 lampholder, one-piece, for cover caps (see p. 291–293)

Material: porcelain, white, T270
 Nominal rating: 4/250/5 kV
 Screw terminals: 0.5–2.5 mm²
 Spring loaded central contact
 Fixing oblong holes for screws M4
 Weight: 66.5 g, unit: 250 pcs.

Type: 62310
Ref. No.: 102624

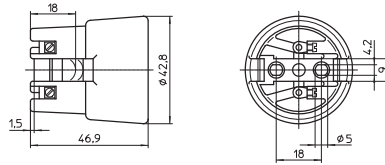

1

2

E27 lampholder

For cover caps type 80010, 97735 and 97742 (see below)

Material: porcelain, white, T270
 Nominal rating: 4/250/5 kV
 Screw terminals: 0.5–2.5 mm²
 Spring loaded central contact
 Fixing holes for screw M4
 Weight: 66.5 g, unit: 250 pcs.

Type: 62370
Ref. No.: 543303

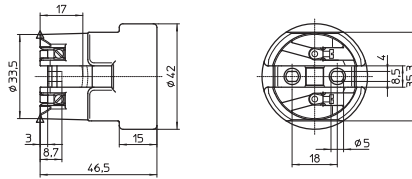

3

4

Cover caps for lampholder 543303

Material: PA GF
 Weight: 12.5/12.5/10/10 g, unit: 500 pcs.
 Type: 97735 moulded thread: M10x1, without locking screw

Ref. No.: 536445 black

Ref. No.: 536446 white

Type: 97742 moulded thread: M10x1, with lateral hole, without locking screw

Ref. No.: 535247 black

Type: 80010 female nipple: G3/8A

Ref. No.: 535694 white

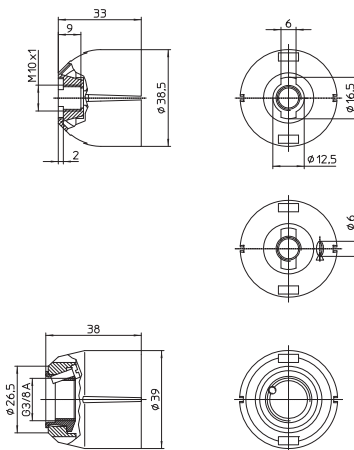

5

6

7

E27 lampholder, three-piece

Material: porcelain, white, T240, nominal rating: 4/250, screw terminals: 0.5–2.5 mm²
 Weight: 116/125/116/125/121.7/130.7 g
 Unit: 25 pcs.

Type: 62061 female nipple: M10x1

Ref. No.: 535684

Ref. No.: 535685 with earth screw

Type: 62062 female nipple: M13x1

Ref. No.: 536451

Ref. No.: 536452 with earth screw

Type: 62063 female nipple: G3/8A

Ref. No.: 534832

Ref. No.: 534833 with earth screw

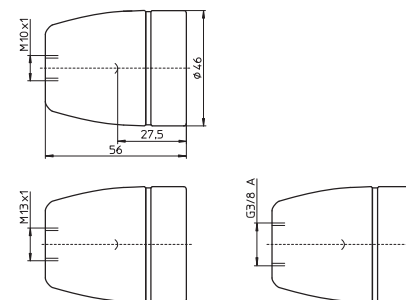

8

9

10

E27 Metal Lampholders, Three-piece

For incandescent lamps with base E27

Nominal rating: 4/250
 Type: 670 plain casing
 Type: 671 threaded casing 40x2.5
 Temperature marking: T240

Inserts

Material: porcelain, white
 Screw terminals: 0.5–2.5 mm²
 Spring loaded central contact, casing lock
 Weight: 22.8/23.3 g, unit: 500 pcs.
 Type: 83221

Ref. No.: 103595

Type: 83223 with earth terminal

Ref. No.: 103597



Plain casings

Material: zinc-coated polished steel
 Weight: 23.5/22.9/27.1/27.1g
 Unit: 500 pcs.
 Type: 83218 insulating threaded ring: PPS
Ref. No.: 103582 chrome-finish
Ref. No.: 103583 brass-finish
 Type: 83226 insulating threaded ring: steatite
Ref. No.: 504640 chrome-finish
Ref. No.: 504641 brass-finish

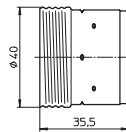

Threaded casings 40x2.5 IEC 60399

Material: zinc-coated polished steel
 Weight: 24/23.1/27.3/27.6 g
 Unit: 500 pcs.
 Type: 83219 insulating threaded ring: PPS
Ref. No.: 103590 chrome-finish
Ref. No.: 103591 brass-finish
 Type: 83227 insulating threaded ring: steatite
Ref. No.: 504643 chrome-finish
Ref. No.: 504644 brass-finish

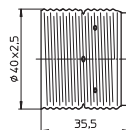

Caps

Material: zinc-coated polished steel
 Female nipple: M10x1
 Weight: 10.6/10.8/11.4/11.3 g
 Unit: 500 pcs.
 Type: 80342
Ref. No.: 103020 chrome-finish
Ref. No.: 103021 brass-finish
 Type: 80343 with earth terminal
Ref. No.: 103026 chrome-finish
Ref. No.: 103027 brass-finish

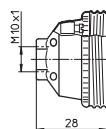
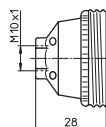

E27 Thermoplastic Pull-switch Lampholders

For incandescent lamps with base E27

Nominal rating: 2/250

Type: 65300 plain casing, with pull cord

Type: 65308 plain casing, with draw chain

Type: 65400 threaded casing 40x2.5, with pull cord

Type: 65408 threaded casing 40x2.5, with draw chain

Insert with pull cord

Material: PET GF, black

Screw terminals: 0.5–2.5 mm²

Length of cord: 250 mm

Weight: 12.3 g, unit: 500 pcs.

Type: 83146

Ref. No.: 507802

End button for pull cord, material: PS, white

Weight: 0.8 g, unit: 500 pcs.

Type: 96010

Ref. No.: 105144

Insert for brass chain

Material: PET GF, black

Screw terminals: 0.5–2.5 mm²

Weight: 11.7 g, unit: 500 pcs.

Type: 83147

Ref. No.: 507803

Draw chain with end button

Material: brass, length of chain: 85 mm

Weight: 3.9 g, unit: 500 pcs.

Type: 94304

Ref. No.: 104928

Plain casings

Material: PET GF

Weight: 11.7 g, unit: 500 pcs.

Type: 96033

Ref. No.: 105179 white

Ref. No.: 109280 black

Threaded casings 40x2.5 IEC 60399

Material: PET GF

Weight: 9.3 g, unit: 500 pcs.

Type: 96034

Ref. No.: 105185 white

Ref. No.: 109281 black

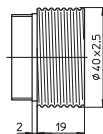
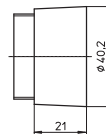
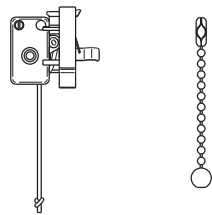
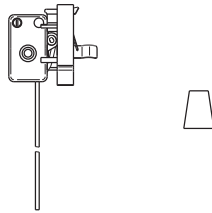

1



2

3



4

5



6

7



8

9

10

Lampholders for General-service Incandescent

Caps

Material: PET GF

Female nipple: M10x1

Weight: 19.8/19.4 g, unit: 500 pcs.

Type: 83258

Ref. No.: 109282 white

Ref. No.: 109283 black

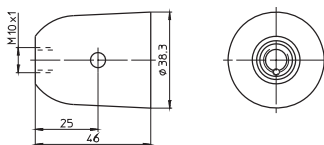

Flange rings

For pull-switch lampholders type 654

Material: PA GF

Ø 60 mm, height: 6.5 mm

Weight: 3/3.1 g, unit: 500 pcs.

Type: 08400

Ref. No.: 501351 white

Ref. No.: 501352 black

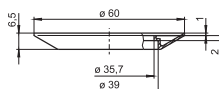

E27 Metal Pull-switch Lampholders

For incandescent lamps with base E27

Nominal rating: 2/250

Type: 55204 plain casing, with pull cord

Type: 55203 plain casing, with draw chain

Type: 55304 threaded casing 40x2.5, with pull cord

Type: 55303 threaded casing 40x2.5, with draw chain



Insert with pull cord

Material: porcelain, white

Screw terminals: 0.5–2.5 mm²

Length of cord: 250 mm, casing lock

Weight: 28 g, unit: 500 pcs.

Type: 83006

Ref. No.: 103504

End button for pull cord, material: PS, white

Weight: 0.8 g, unit: 500 pcs.

Type: 96010

Ref. No.: 105144

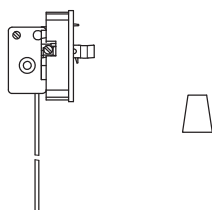

Insert for brass chain

Material: porcelain, white

Screw terminals: 0.5–2.5 mm²

Weight: 29.4 g, unit: 500 pcs.

Type: 83008

Ref. No.: 103515

Draw chain with end button

Material: brass, length of chain: 85 mm

Weight: 3.9 g, unit: 500 pcs.

Type: 94304

Ref. No.: 104928

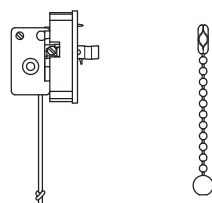

Lampholders for General-service Incandescent

Casings

Material: brass, passivated
 Insulating threaded ring: PPS
 Weight: 21.5/22.7 g, unit: 500 pcs.

Type: 83218 plain casing

Ref. No.: 103587

Type: 83219 threaded casing 40x2.5

Ref. No.: 103594

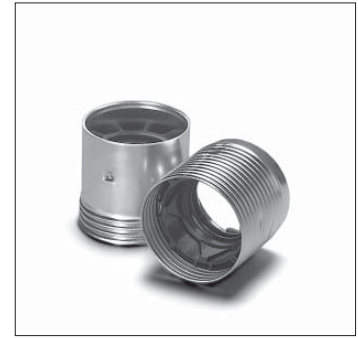
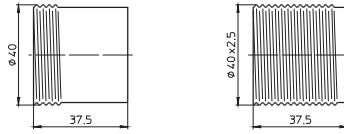

1

Cap with earth terminal

Material: brass, passivated

Female nipple: M10x1

With insulating insert

Weight: 20 g, unit: 500 pcs.

Type: 80014

Ref. No.: 102956

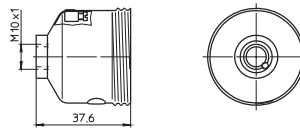

3

4

E27 Thermoplastic Rocker Switch Lampholders

For incandescent lamps with base E27

Nominal rating: 2/250

Temperature marking: T180

Suitable casings see page 295:

Type: 83000 plain casing

Type: 83002 threaded casing 40x2.5

Type: 83173 threaded casing 40x2.5, with flange

Inserts with switch

Material: PET GF, white

Screw terminals: 0.5–2.5 mm²

Weight: 11/11.1 g, unit: 500 pcs.

Type: 83015

Ref. No.: 107331 switch, white

Ref. No.: 107096 switch, black

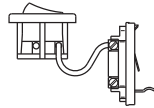

5

6



7

8

Caps

Material: PA GF

Female nipple: M10x1

Weight: 14.2/14.7 g, unit: 500 pcs.

Type: 83260

Ref. No.: 109198 white

Ref. No.: 109199 black

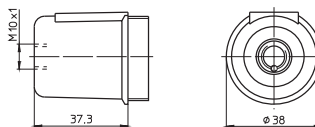

9

10

Lampholders for General-service Incandescent

Caps

Material: PA GF

Profiled hole: \varnothing 10.4 mm

Rotation stop: internal and external

Weight: 8.2/10.4 g, unit: 500 pcs.

Type: 96229

Ref. No.: 109200 white

Ref. No.: 109201 black

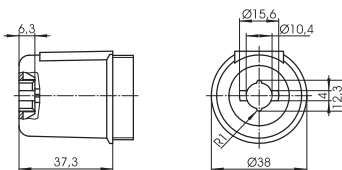

E27 Festoon Lampholders

For lighting chains of protection class II

Degree of protection: IP44

Type: 64710/11

The lampholders may only be operated with the lamp pointing downwards and with a gasket.

E27 festoon lampholder

For lamps max. 40 W

Material: PBT GF, black

Nominal rating: 4/250

Blade contacts

for festoon lead H05RN H2-F 2X1.5

To be used only with protection cap

Weight: 13.8 g, unit: 500 pcs.

Type: 83297

Ref. No.: 109158

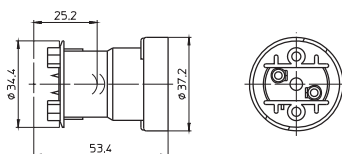

Protection cap

For E27 festoon lampholders

Material: PA GF, black

With ready-fitted stainless screws

Weight: 6.3 g, unit: 500 pcs.

Type: 83300 with non-removable screws

Ref. No.: 109243

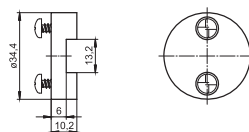

Lampholders for General-service Incandescent

Protection cap

For E27 festoon lampholders

Material: PA GF, black

With ready-fitted stainless screws

Fixing holes for screws M4

Weight: 7.2 g, unit: 500 pcs.

Type: 83301 with non-removable screws

Ref. No.: 502515

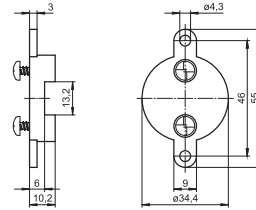

1

2

Gasket

For E27 festoon lampholders

Material: silicone

Weight: 4 g, unit: 500 pcs.

Type: 98006

Ref. No.: 106817

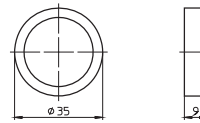

3

4

B22d Lampholders, Accessories

For mains voltage halogen incandescent lamps

B22d lampholders

For cover caps (see p. 291–293)

Nominal rating: 2/250

Push-in twin terminals: 0.5–1.5 mm²

Fixing holes for self-tapping screws

acc. to ISO 1481/7049-ST3.9-C/F

Weight: 12.7/12.3 g, unit: 500 pcs.

Type: 64800

Ref. No.: 108748 PET GF, T180, white

Ref. No.: 544621 PET GF, T210, white

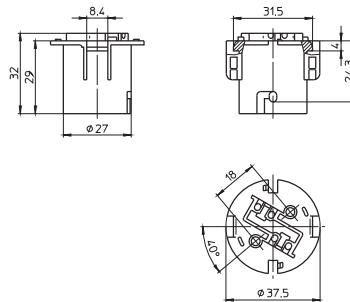

6

7

8

Plain casing

For B22d lampholders type 64800

For cover caps (see p. 291–293)

Threaded casing on request

Material: PA GF, white

Weight: 14.5 g, unit: 500 pcs.

Type: 96021

Ref. No.: 504749

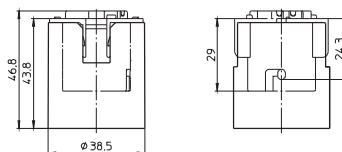

9

10

Lampholders for General-service Incandescent

B22d lampholder

With protection flange

For cover caps type 80010, 97735 and 97742 (see below)

Casing: porcelain, white, T240

Nominal rating: 2/250

Screw terminals: 0.5–2.5 mm²

Fixing holes for screws M3

Weight: 84.7 g, unit: 150 pcs.

Type: 64900

Ref. No.: 535673

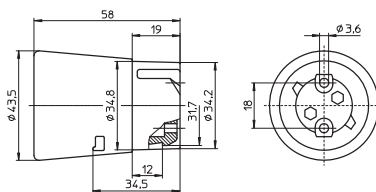

B22d lampholder

Casing: porcelain, white, T240

Nominal rating: 2/250

Screw terminals: 0.5–2.5 mm²

Lateral fixing bracket

Tilt angle: 15°

Fixing hole for screws M4

Weight: 70 g, unit: 150 pcs.

Type: 64940

Ref. No.: 535674

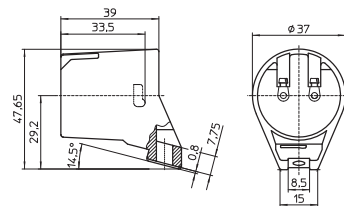

Cover caps for lampholder 535673

Material: PA GF

Weight: 12.5/12.5/10/10 g, unit: 500 pcs.

Type: 97735 moulded thread: M10x1, without locking screw

Ref. No.: 536445 black

Ref. No.: 536446 white

Type: 97742 moulded thread: M10x1, with lateral hole, without locking screw

Ref. No.: 535247 black

Type: 80010 female nipple: G3/8A

Ref. No.: 535694 white

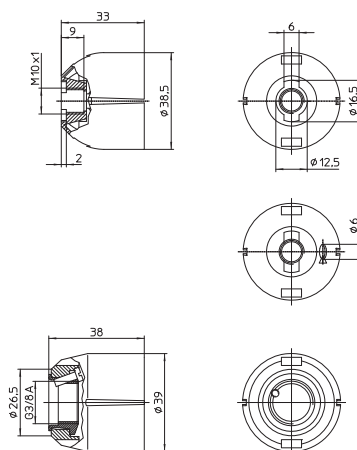

Accessories

For E14, E27 lampholders, one-piece and three-piece and B22d lampholders

The luminaire manufacturer is responsible for the right choice of accessories.
Brass-finished versions are available on request.

Plastic screw rings

For E14 lampholders

with external thread 28x2 IEC 60399

Weight: 3.6/3.2/1.8/1.6 g, unit: 1000 pcs.

Type: 03210 Ø 43 mm, height: 15 mm

Ref. No.: 100125 PET GF, white

Ref. No.: 109162 PA GF, black

Type: 05202 Ø 34 mm, height: 7.5 mm

Ref. No.: 107154 PET GF, white

Ref. No.: 109166 PA GF, black

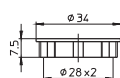
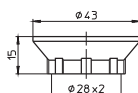

Metal screw ring

For E14 lampholders

with external thread 28x2 IEC 60399

Material: zinc-coated polished steel, chrome-finish

Ø 40 mm, height: 12 mm

Weight: 4.3 g, unit: 500 pcs.

Type: 06700

Ref. No.: 100194

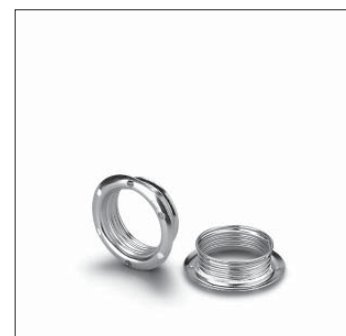
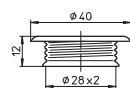

Front gasket

For E14 lampholders type 64305, 64306, 64308, 64313, 64316, 64360, 64380 and 64381

As lamp safety catch and for protection against moisture acc. to IEC 60079-15

Material: elastomer

Weight: 1.1 g, unit: 2000 pcs.

Type: 98013

Ref. No.: 534689



Plastic screw rings

For E27 and B22d lampholders

Weight: 4.9/4.4/3.3/3 g, unit: 500 pcs.

Type: 08610 Ø 55 mm, height: 15 mm

Ref. No.: 100270 PET GF, white

Ref. No.: 109285 PA GF, black

Type: 08701 Ø 47.8 mm, height: 9 mm

Ref. No.: 100273 PET GF, white

Ref. No.: 109291 PA GF, black

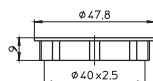
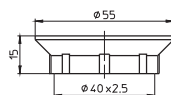

1

2

3

4

5

6

7

8

9

10

Lampholders for General-service Incandescent

Metal screw ring

For E27 and B22d lampholders

Material: zinc-coated polished steel, chrome-finish

Ø 56.5 mm, height: 13 mm

Weight: 7 g, unit: 500 pcs.

Type: 07400

Ref. No.: 100217

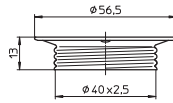

Brackets for E14 lampholders

For fastening with nipples 109249, 109247

Material: zinc-coated polished steel

Fixing holes for screws M3

Weight: 5.5/5.3/5.3 g, unit: 1000 pcs.

Type: 94068 internal bracket 90°

Ref. No.: 106767

Type: 94066 external bracket 90°

Ref. No.: 400671

Type: 94069 internal bracket 110°

Ref. No.: 106768

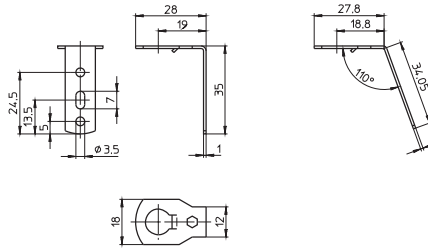

Bracket 90° for E14 lampholders

For fastening with nipples 109249, 109247

Material: zinc-coated polished steel

Fixing holes for screws M3

Weight: 6.2/8.5/8.5 g, unit: 1000 pcs.

Type: 94074 external bracket 18.5x33 mm

Ref. No.: 106802 holes diagonal

Type: 94067 external bracket 24x41.5 mm

Ref. No.: 106766 holes vertical

Type: 94079 internal bracket 24x41.5 mm

Ref. No.: 506211 holes vertical

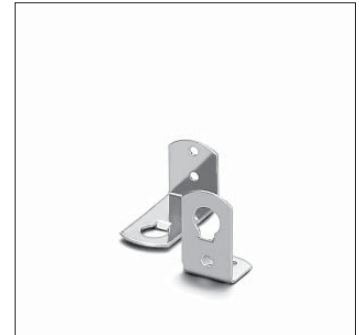
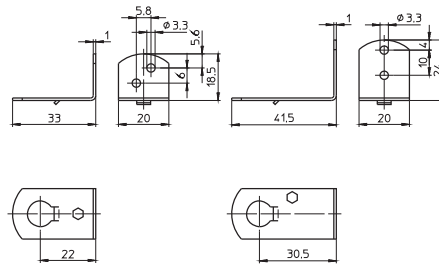

U-shaped clips

For E27 lampholders, one-piece

Material: zinc-coated polished steel, chrome-finish

For wall thickness: 0.5–2 mm

Weight: 3.7/4.3 g, unit: 2500 pcs.

Type: 94435

Ref. No.: 109621

Type: 80433 with earth terminal

Ref. No.: 103087

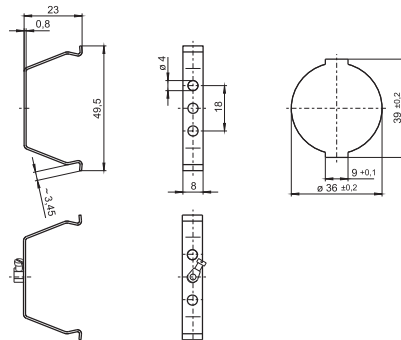

Base clips

For E14 and E27 lampholders, one-piece

Material: zinc-coated polished steel, chrome-finish

For wall thickness: 0.8–1.5 mm

Weight: 3.3/4 g, unit: 2500 pcs.

Type: 94436

Ref. No.: 109622

Type: 80474 with earth terminal

(without drawing)

Ref. No.: 400699

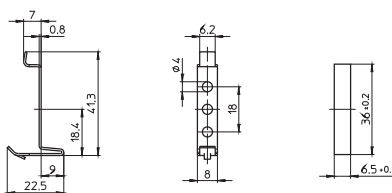

Lampholders for General-service Incandescent

Fixing brackets: 8°, 14.4x39 mm
 For E27 thermoplastic lampholders, one-piece
 Material: PET GF, white
 Oblong hole for screw M4
 Weight: 1.9/4.3 g, unit: 1000 pcs.
 Type: 97159 fixing holes: Ø 4 mm

Ref. No.: 108304

Type: 97755 fixing holes for self-tapping screws acc. to ISO 1481/7049-ST3.9-C/F

Ref. No.: 400732

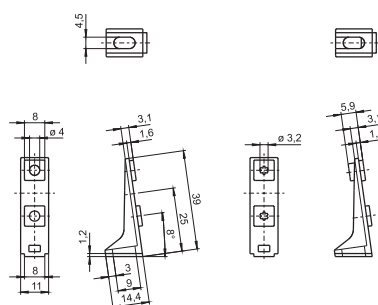

Fixing bracket: 8°, 20x44.4 mm
 For E27 thermoplastic lampholders, one-piece
 Material: PET GF, white
 Fixing holes: Ø 4 mm
 With cable holder
 Oblong hole for screw M4
 Weight: 3.7 g, unit: 1000 pcs.
 Type: 97754

Ref. No.: 401970

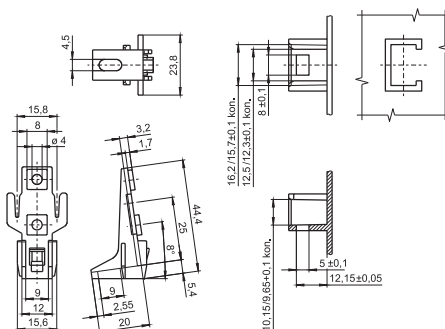

Nipples

For E14 cover caps with moulded thread: M10x1
 Cross groove for rotation stop: external
 For E27 caps (see p. 296–297), for fastening of brackets 106766 and 106802 (see p. 308)

Material: PA, white

Male nipple: M10x1, with hexagon flange

Weight: 0.5 g, unit: 1000 pcs.

Type: 09700/09703/09708

Ref. No.: 538089 length: 15 mm

Ref. No.: 109249 length: 10 mm

Ref. No.: 109247 length: 7 mm

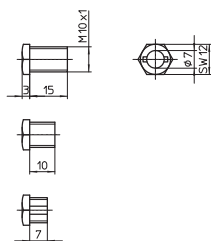

Locking nut for thread M10x1

Material: PA GF

Weight: 0.9 g, unit: 1000 pcs.

Type: 97267

Ref. No.: 507797 white

Ref. No.: 507798 black



Cord grip with insulating socket

For E14 and E27 lampholders

Material: PA, natural

For luminaires of protection class II

For leads H03VVH2-F 2X0.75

Weight: 0.6 g, unit: 1000 pcs.

Type: 97632

Ref. No.: 534097

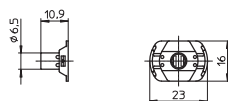

Lampholders for General-service Incandescent

Cable grips

For leads H03VV-F and H03VVH2-F 2X0.5 or 2X0.75

Material: PA

Male nipple: M10x1, length: 11 mm

With locking screw

Weight: 1.6/1.5 g, unit: 1000 pcs.

Type: 09701

Ref. No.: 109248 white

Ref. No.: 109253 black

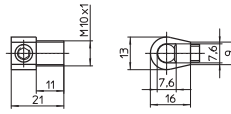

1

2

Cord grip

For E14 lampholders, three-piece, with cap height: 19 mm

For leads H03VVH2-F

Material: PA, black

Weight: 0.6 g, unit: 1000 pcs.

Type: 09501

Ref. No.: 106948



3

4

Cord grip

For E27 lampholders, three-piece (without switch)

For leads H03VVH2-F

Weight: 0.9 g, unit: 1000 pcs.

Type: 09502

Ref. No.: 106949 PA, black

Insulating socket

Material: PA, transparent

Weight: 0.5 g, unit: 1000 pcs.

Type: 09705

Ref. No.: 109592

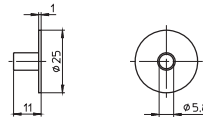

5

6

Cord grips

For leads H03VV-F 2X0.5 or H03VV-F 2X0.75

Material: PA

Weight: 0.9/0.8/1.7/1.6 g, unit: 1000 pcs.

Type: 09606 cord grips

Ref. No.: 506026 white

Ref. No.: 506027 black

Type: 96160 screw caps

Ref. No.: 109318 white

Ref. No.: 109317 black



7

8

Cord grips

For leads H03VV-F 2X0.5 or H03VV-F 2X0.75

Material: PA, male nipple: M10x1

Weight: 1/0.9/1.7/1.6 g, unit: 1000 pcs.

Type: 09607 cord grips

Ref. No.: 506024 white

Ref. No.: 506020 black

Type: 96160 screw caps

Ref. No.: 109318 white

Ref. No.: 109317 black



9

10

Lampholders for General-service Incandescent

Insulating socket for E14 lampholders

Material: PA, transparent

Weight: 1 g, unit: 1000 pcs.

Type: 09704

Ref. No.: 109600

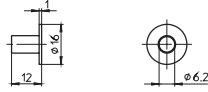

E40 Porcelain Lampholders

For incandescent lamps with base E40

Nominal rating: 18/500/5 kV
 Screw terminals: 1.5–4 mm²
 Spring loaded central contact

E40 lampholders

Material: porcelain, white, T270
 Oblong holes for screws M5
 Weight: 224/229.3/224/229.3 g
 Unit: 48 pcs.
 Type: 12800/12801

Ref. No.: 108208

Ref. No.: 107780 with lamp safety catch

With steel thread

Ref. No.: 532602

Ref. No.: 532603 with lamp safety catch

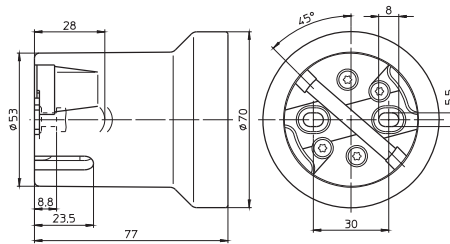

E40 lampholders

Material: porcelain, white, T270
 Fixing bracket with slots for screws M5
 Weight: 252.3/243/252.3/243 g
 Unit: 48 pcs.
 Type: 12810/12811

Ref. No.: 108374

Ref. No.: 108375 with lamp safety catch

With steel thread

Ref. No.: 532604

Ref. No.: 532605 with lamp safety catch

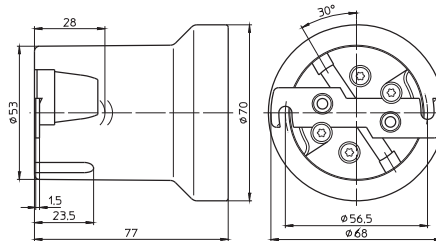

E40 lampholders

Material: porcelain, white, T270
 Fixing bracket with tapped holes for screws M5
 With lamp safety catch
 Weight: 252.8 g, unit: 48 pcs.
 Type: 12812

Ref. No.: 108373

With steel thread

Ref. No.: 532606

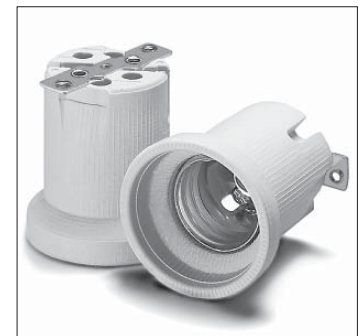
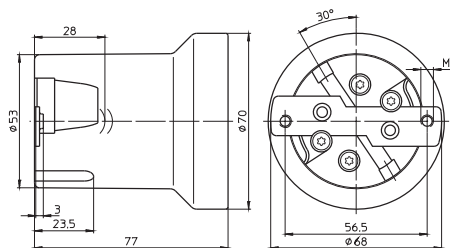

1

2

3

4

5

6

7

8

9

10

5

Components for Incandescent Lamps

Transformers and converters for low-voltage halogen lamps	315
Dimmability of VS transformers and VS converters	316
Electronic converters	316–320
Assembly instructions – Electronic converters	317–320
Electromagnetic transformers	321–325
Assembly instructions – Electromagnetic transformers	322–325
Conductors for low-voltage halogen installations	324–325
Lampholders for incandescent lamps	325–326
Retrofit Lamps	327
General technical details	348–356
Glossary	357–359

Transformers and converters for low-voltage halogen lamps

Operating low-voltage halogen lamps depends on operating devices that transform the usual mains voltage of 230 V to under 24 V. Safety transformers, of either electromagnetic or electronic (converter) design, have been in almost exclusive use for several years now. The type plate of electromagnetic transformers bears the symbol for safety transformers in accordance with VDE 0570, corresponding to EN 61558. Electronic converters are marked with the sign for Safety Extra-Low Voltage (SELV), which indicates that the product is an isolating converter whose secondary output is safe to touch even during no-load operation.

All Vossloh-Schwabe transformers are safety transformers, i.e. isolation transformers for supplying SELV (safety extra-low voltage) and PELV (protection extra-low voltage) circuits. With such systems, the voltage must not exceed a value of 50 V AC or 120 V DC (smoothed) between the conductors or a conductor and the earth conductor of a circuit that is separated from the mains by a safety transformer. The specified values apply for protected (non-touchable) voltages; 25 V AC and 60 V DC (smoothed) apply for exposed (touchable) voltages.

Depending on their design features to protect against touchable live parts, transformers and converters fall into one of two protection classes. Operating devices of protection class I are base-insulated and have a protective earth conductor connection terminal that must be connected to the protective earth conductor for safety reasons. Isolating transformers and converters of protection class II are equipped with double or reinforced insulation that protects against dangerous casing currents; these operating devices are solely available as independent operating devices (also see page 353; Protection Classes of Luminaires and Operating Devices).

Electronic converters can also be fitted with a functional earth terminal that must be connected to a functional earth to ensure compliance with EMC requirements. In addition, some electronic converters are designed in such a way that neither a protective earth conductor nor a functional earth needs to be connected.

Operating devices can also be differentiated according to the way they are used. Built-in transformers have to be installed in a permanent casing, e.g. a luminaire. In contrast, so-called independent transformers and converters can be operated independently of a luminaire. These are often found in ceiling installations; in order to prevent possible noise development, isolation transformers must be mounted in such a way as to avoid vibration transmission.

Transformers or converters bearing the MM mark can be mounted on surfaces of unknown flammability, which can be the case when mounting these devices on wooden furniture elements. Such devices comply with the temperature requirements of VDE 0710, part 14, of < 95 °C during normal and < 115 °C during abnormal operation.

Converters are labelled with a t_c point. The stipulated temperature (e.g. 75 °C) must not be exceeded when installed so that the service life of the converter is not shortened. The temperature quoted in the triangle (e.g. 110) denotes that the surface of the converter must never (even in the event of a defect) exceed this temperature.

Protection symbols



Safety transformer

SELV

Safety Extra Low Voltage



Protection class II



Independent operating device



Furniture installation
Normal operation < 95 °C
Abnormal operation < 115 °C

If the maximum value of 130 °C is not exceeded, the luminaire does not have to be tested in accordance with ∇ conditions.



$t_c = 75 \text{ °C}$
Measuring point for maximum permissible casing temperature



Temperature-protected converter
(in this case < 110 °C)

1

2

3

4

5

6

7

8

9

10

Dimmability of VS transformers and VS converters

Electromagnetic VS transformers can be controlled using phase-cutting leading-edge dimmers. These dimmers "cut" the sinusoidal mains voltage in the negative and positive half wave at an angle in the ascending portion of this sinusoidal half wave. The higher the angle is set at the dimmer controls, the lower the effective value of the voltage and hence the lamp's output.

Electronic VS converters can be controlled using phase-cutting trailing-edge dimmers. In this case, a semiconductor ensures the predefined descending portion of the sinusoidal half wave is clipped, i.e. the voltage is reduced in reverse mode. Again, higher the angle is set at the dimmer controls, the lower the effective value of the voltage and hence the lamp's output.

Converters of the LiteLine (EST 70/12.380, EST 105/12.381, EST 150/12.622 and EST 60/12.635) families can be operated using conventional phase-cutting trailing-edge and phase-cutting leading-edge dimmers.

Electronic Converters

The safe operation of electronic converters is dependent on the maximum permissible temperature not being exceeded at the measuring point. Vossloh-Schwabe has determined a casing temperature measuring point – $t_{c \text{ max.}}$ – on all converter casings. To avoid shortening the service life or diminishing operating safety, the stipulated maximum temperature must not be exceeded at this t_c point. This point is determined by testing the converter during normal, IEC-standardised operation at the specified max. ambient temperature (t_a), which is also indicated on the type plate. As both the design-related ambient temperature and the converter's inherent heat generation, as determined by the installed load, are subject to great variation, the casing temperature should be tested at the converter's t_c point under real installation conditions.

Temperature-protected converters feature a further protection symbol, namely a triangle containing the maximum temperature. This symbol certifies that the stipulated surface temperature of the device casing will not be exceeded during any operating state or in the event of a defect.

Vossloh-Schwabe electronic converters are tested in accordance with EN 61347. Function tests are carried out in accordance with EN 61047. VS converters can be operated without causing any inadmissible system reactions as all devices comply with EN 61000-3-2 on the limitation of mains harmonics. They also meet the EMC requirements of EN 61547. These devices are thus also protected against mains surges (as defined in the standard) that can be caused by, for instance, inductive ballasts during combined operation of fluorescent and low-voltage halogen lamps.

In addition, all devices comply with the RFI requirements of EN 55015. As the highly effective integrated filter can only limit the unit's own interference, the secondary conductor should be kept to under 2 metres in length so as to avoid RFI interference in the lighting system.

Dimmable using phase-cutting leading-edge or trailing-edge dimmers



Dimmable using phase-cutting leading-edge dimmers



Dimmable using phase-cutting trailing-edge dimmers



Working principle of a phase-cutting leading-edge dimmer

α = Ignition angle
 λ = Operating angle
 U = Voltage
 I = Current

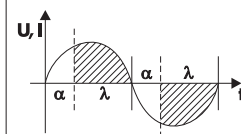

Working principle of a phase-cutting trailing-edge dimmer

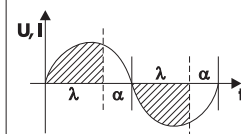

Assembly Instruction for Electronic Converters

For mounting and installing electronic converters for low-voltage halogen lamps

Mandatory regulations

DIN VDE 0100	Erection of low voltage installations
EN 60598-1	Luminaires – part 1: general requirements and tests
EN 61000-3-2	Electromagnetic compatibility (EMC) – part 3: maximum values – main section part 2: maximum values for mains harmonics (device input current up to and including 16 A per conductor)
EN 55015	Maximum values and methods of measurement for RFI suppression in electrical lighting installations and similar electrical appliances
EN 61547	Installations for general lighting purposes – EMC immunity requirements
EN 61347-1	Operating devices for lamps – part 1: general and safety requirements
EN 61347-2-2	Operating devices for lamps – part 2-2: special requirements for DC- or AC-powered electronic converters for incandescent lamps
EN 61047	DC- or AC-powered electronic converters for incandescent lamps – performance requirements

Designations for VS converters

Designations for electronic converters are first listed by the name of the product family, which in each case reflects the visible product properties. The type designation should be read as follows:

EST	60	/12	.388
Electronic safety transformer	Max. wattage	Lamp voltage	Serial number

Mechanical mounting

Mounting position Any

Clearance Min. of 0.1 m from walls, ceilings, insulation; min. of 0.1 m from other electronic converters; min. of 0.25 m from sources of heat (lamp)

Surface Solid; device must not be allowed to sink into insulation materials

Mounting location In dry rooms or in luminaires, cases, casings or similar in the instance of built-in converters

Fastening Independent converters: using screws, Ø 4 mm

Heat transfer If the electronic converter is destined for installation in a luminaire, sufficient heat transfer must be ensured between the converter and the luminaire casing. During operation, the t_c point must not exceed the specified value.

1

2

3

4

5

6

7

8

9

10

Technical specifications

Type		Operating voltage range AC	Dimmability		Temperature protection	Through-wiring ³	Type of automatic cut-out and number of possible VS devices			
			Unsuitable for DC operation	Phasecutting trailing edge ¹			Phasecutting leading edge ¹	Electronic control ²	Converter quantity	B (10A)
LiteLine	EST 70/12.380	230–240	x	x	x	—	28	45	28	45
	EST 105/12.381	230–240	x	x	x	—	20	32	20	32
	EST 150/12.622	230–240	x	x	x	—	14	23	14	23
...Mini	EST 60/12.635	220–240	x	x	x	—	35	56	35	56

- ¹ The dimmer is connected to the primary side between mains and converter.
It is possible to connect several converters to one dimmer (whereby the dimmer's minimum and maximum load must be observed).
The dimmer-converter system should be subjected to function and noise development tests prior to installation.
- ² The rating is decreased electronically in the event of overheating.
- ³ Distributed secondary leads are only permitted on non-metallic surfaces (RFI suppression)

Properties of electronic converters

- Overheating** Protection against overheating is provided by an electronic controller (see table above).
- Short-circuit** The converter will be electronically disconnected in the event of a short-circuit at the output; once the short-circuit has been eliminated, the converter will switch on again automatically.
- Overload** Minor overloads (< 50%) will trigger the temperature switch against overheating; major overloads (> 50%) will trigger the same reaction as for short-circuit.

Should any of the above-mentioned safety functions be triggered, disconnect the converter from the power supply, then find and eliminate the cause of the problem.

Protection against transient mains peaks
Values compliant with EN 61547 (immunity)

Electrical installation

Conductors Primary conductor cross-section: min. 0.75 mm²
 Secondary conductor cross-section: min. 0,75 mm² for 50 W output and min. 1 mm² for 100 W output

Stripping

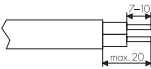
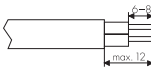
Converter	60/12.635	70/12.380, 105/12.381, 150/12.622
Type of lead	All usual types of lead up to 4 mm ²	H03-VH2-F 2X0.75 H05-VH2-F 2X0.75 H03-W-F 2X0.75 H05-W-F 2X0.75
Lead preparation		

Connections Screw terminals: max. initial torque of 0.4 Nm must not be exceeded

Secondary length Min. 0.25 m (clearance to lamp), max. 2 m (RFI protection)

Secondary wiring Min. 0.1 m clearance from the mains (RFI protection)

Star wiring Twist single-wire or lead wires narrowly; silicone-insulated leads are recommended

Parallel connection Secondary-side parallel connection is inadmissible

Feed-through of the mains voltage See table on page 318
 Distributed secondary leads are only permitted on non-metallic surfaces (RFI suppression)

Selection of automatic cut-outs for VS converters

Dimensioning automatic cut-outs

High transient mains current pulses occur when a converter is switched on because the capacitor has to load. As the lamps ignite almost simultaneously, this also creates a high power drain. The high currents that occur when the system is switched on put a strain on the automatic conductor cut-outs, which must be selected and dimensioned to suit.

Release reaction Release reaction of automatic cut-outs in accordance with VDE 0641, Part 11; for B and C characteristics. The values provided in the table on page 318 are meant as guidelines only and may vary depending on the respective lighting system.

No. of converters The maximum number of VS converters (see table on page 318) applies to cases where the devices are switched on simultaneously. Specifications apply to single-pole fuses. The number of permissible ballasts must be reduced by 20% for multi-pole fuses. The considered circuit impedance equals 400 mΩ (approx. 20 m [2.5 mm²] of conductor from the power supply to the distributor and a further 15 m to the luminaire).

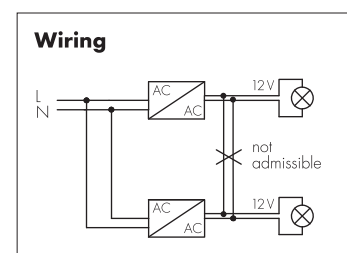
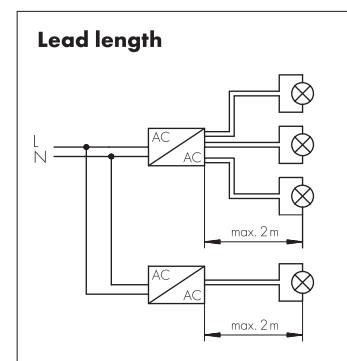
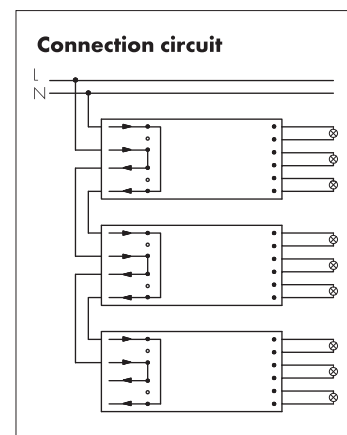

Dimmability of electronic converters

Dimmed operation

VS converters can be operated with phase-cutting trailing-edge dimmers. Some converters can additionally be operated with phase-cutting leading-edge dimmers (see table on page 326). The dimmer is connected to the primary side between mains and converter. It is possible to connect several converters to one dimmer (whereby the dimmer's minimum and maximum load must be observed). The dimmer-converter system should be subjected to function and noise development tests prior to installation.

Electromagnetic compatibility (EMC)

Mains Harmonics

Maximum values are observed in accordance with EN 61000-3-2.

Interference

The requirements of EN 55015 must be met for luminaires with converters for operating low-voltage halogen lamps. Vossloh-Schwabe converters are designed and manufactured to ensure these requirements are satisfied provided the installation instructions regarding the interference voltage at the connection terminals and electromagnetic interference fields up to 300 MHz are observed.

Additional information

Wiring

To ensure good radio interference suppression and the greatest possible operating safety, the following points should be observed when installing electronic converters:

- Conductors between the EST and the lamp (HF conductors) must be kept short (reduction of electromagnetic interference).
- Mains and lamp conductors must be kept separate and if possible should not be laid in parallel to one another. The distance between HF conductors and mains conductors should be as large as possible, ideally > 5 cm. (This prevents the induction of interference between the mains and lamp conductors).
- The mains conductor within the luminaire must be kept short (to reduce the induction of interference).
- The mains conductor must not be laid too close to the EST (this is especially important in the event of through-wiring).
- Mains and lamp conductors must not be crossed. Should this be impossible to avoid, conductors should be crossed at right angles to one another (to avoid inducing interference between mains and HF conductors).
- Should conductors be wired through metal parts, such conductors must always be additionally shielded (e.g. with an insulating sleeve or grommet).

Temperature

Reference point temperature t_c

The safe operation of electronic converters is dependent on the maximum permissible temperature not being exceeded at the measuring point. Vossloh-Schwabe has determined a casing temperature measuring point – $t_{c \max}$ – on all converter casings. To avoid shortening the service life or diminishing operating safety, the stipulated maximum temperature must not be exceeded at this t_c point. This point is determined by testing the converter during normal, IEC-standardised operation at the specified ambient temperature (t_a), which is also indicated on the type plate. As both the design-related ambient temperature and the converter's inherent heat, as determined by the installed load, are subject to great variation, the casing temperature should be tested at the t_c point under real installation conditions.

Ambient temperature t_a

The ambient temperature – as specified on every converter – denotes the permissible temperature range within the luminaire or at the place of installation.

Reliability Service life of 50,000 hrs at reference point temperature t_c , whereby a switching cycle of 165 minutes on and 15 minutes off is assumed. Failure rate: $\leq 0.2\%/1,000$ hrs
In order to achieve the average service life, the maximum temperature (t_c max.) must not be exceeded at the t_c point.

Emergency lighting VS electronic converters cannot be used for emergency lighting purposes as they are unsuitable for DC voltage operation.

Electromagnetic Transformers

Owing to the low internal impedance of electromagnetic transformers, high currents can occur in the event of a short-circuit on the secondary side, which can lead to the transformer being destroyed. For this reason, IEC 61558-1 differentiates between three types of transformer:

Transformers without short-circuit resistance

These transformers require external protection to prevent excessive temperatures being generated.

At Vossloh-Schwabe, these transformers are marked with the symbol "not short-circuit proof safety transformer". To protect against current overload during overload or short-circuit operation, Vossloh-Schwabe recommends installing a fuse on the primary side. As an aid to the user, the rating of this fuse is stated on the type plate in accordance with IEC 60127. The installed primary-side fuse should be easily accessible so that it can be readily replaced at any time.

Transformers with (limited) short-circuit resistance

These transformers feature a safety device that prevents excessive temperatures being generated.

Electromagnetic transformers with thermal cut-outs afford a limited degree of short-circuit resistance and do not need to be additionally fused. VS safety transformers of limited short-circuit resistance are designed to safely cut out in the event of overload or short-circuit, but not to restart automatically after cooling off. The transformer must first be disconnected from the mains (i.e. switched off and on) before it can be restarted. The thermal cut-outs are dimensioned to ensure that the maximum permissible winding temperature of 225 °C (transformers of thermal class B) or 240 °C (F) or 260 °C (H) is not exceeded in the event of overload or short-circuit.

Transformers with (unlimited) short-circuit resistance

These transformers are designed to ensure that fixed maximum temperatures are not exceeded in the event of overload or short-circuit.

This type of safety transformer is not in common use within the lighting industry due to the relatively large dimensions it needs to meet the overload and short-circuit requirements.

All transformers will function perfectly and meet the requirements of the standard after the overload or shortcircuit has been eliminated.

In addition to the above, there are also so-called **failsafe transformers** that are rendered permanently inoperative in the event of improper use, but do not pose a threat to the user or the surroundings. Vossloh-Schwabe does not provide this type of isolation transformer.

All Vossloh-Schwabe transformers are tested for compliance with the safety requirements of European standard EN 61558 regarding creepage and air clearance distances, the winding temperature and the maximum permissible ambient temperature (t_a).

Protection symbols



Non short-circuit proof safety transformer



Limited short-circuit proof safety transformer



Rated fuse value

t_a 65

Transformer's maximum permissible ambient temperature



Thermal cut-out (reset after disconnection from the mains)

1

2

3

4

5

6

7

8

9

10

EN 61558 specifies five insulation classes for electromagnetic transformers; respective testing temperatures and times are assigned to these classes. Due to the quality of the insulation materials used by Vossloh-Schwabe, VS transformers are only available in the three highest insulation classes B (120°C), F (140°C) and H (165°C). In this case, the quoted temperature refers to the maximum permissible winding temperature during permanent operation.

As luminaire casings made of plastic or sheet metal will discharge heat to varying degrees and because transformer installation conditions can differ, a transformer's winding temperature must be tested within the luminaire. The measured values will show whether the maximum temperature corresponds to the transformer's insulation class.

On request, Vossloh-Schwabe can carry out such luminaire tests to assess built-in components.

Assembly Instruction for Electromagnetic Transformers

For mounting and installing electromagnetic transformers for low-voltage halogen lamps

Mandatory regulations

DIN VDE 0100	Erection of low voltage installations
EN 60598-1	Luminaires – part 1: general requirements and tests
EN 61558-1	Safety of transformers, power supply units and similar – part 1: general requirements and tests
EN 61558-2-6	Safety of transformers, power supply units and similar – part 2-6: special requirements for safety transformers for general use
EN 61000-3-2	Electromagnetic compatibility (EMC) – part 3: maximum values – main section part 2: maximum values for mains harmonics (device input current up to and including 16 A per conductor)
EN 55015	Maximum values and testing methods for radio disturbance of electrical lighting facilities and similar electrical equipment
EN 61547	Installations for general lighting purposes – EMC immunity requirements

Technical specifications

Mains voltage range	VS safety transformers can be operated at the specified mains voltage within a tolerance range of $\pm 10\%$
Leak current	≤ 0.1 mA per safety transformer
Power factor	$\lambda \geq 0.85$
Compensation	Not required

Mechanical mounting

Mounting position

Any

Mounting location

Safety transformers are designed for installation in luminaires or comparable devices. Independent safety transformers do not need to be built into a casing.

Fastening

Preferably using screws, Ø 4 mm

Insulation classes and maximum temperatures

In accordance with EN 61558, safety transformers are assigned to insulation classes on the basis of the insulation materials used (also called insulation material classes for this reason) in the transformers. These insulation classes also prescribe respective maximum winding temperatures that must not be exceeded during normal operation or in the event of overload or short-circuit.

Compliance with the maximum winding temperatures is tested by measuring the resistance of the transformer's copper winding.

Insulation classes for safety transformers in accordance with EN 61558-1

	A	E	B	F	H
Max. winding temperature (1.06 U _N) during normal operation	100 °C	115 °C	120 °C	140 °C	165 °C
Max. winding temperature in the event of overload or shortcircuit	200 °C	215 °C	225 °C	240 °C	260 °C

Electromagnetic compatibility (EMC)

Interference

Interference voltage measurements do not have to be taken for luminaires with magnetic safety transformers for operating low-voltage halogen lamps as these are systems with lamp voltages of under 100 Hz and it is assumed that such systems do not cause interference.

Interference immunity

Thanks to the robust design and choice of materials, magnetic safety transformers provide a high degree of interference immunity and are not impaired by admissible mains power interference.

Mains harmonics

Owing to the Ohmic resistance characteristics of low-voltage halogen lamps and the low degree of distortion caused by magnetic transformers, mains harmonics remain low.

Safety functions of VS transformers

Load	Transformer features	
	Unprotected (OS)	With self-locking temperature protection (TS)
Overheating	Is not recorded	Protection is provided by the built-in thermal switch
Short-circuit	Protection must be provided	
Overload	by devices fitted in the luminaire (fuse or thermal switch)	

Should one of the safety functions be triggered, the transformer must be disconnected from the mains, the cause of the fault found and then eliminated.

1

2

3

4

5

6

7

8

9

10

Dimmer operation

VS safety transformers can be controlled using progressively adjustable phase-cutting leading-edge dimmers for low-voltage halogen lamps.

Reliability and service life

VS safety transformers are designed for a long service life. Provided the specified maximum values for the winding temperature are complied with during operation, a service life of 10 years can be expected. Failure rate: < 0.025%/1,000 hrs

Electrical installation

Conductors Primary conductor cross-section: min. 0.75 mm²,
secondary conductor cross-section: min. 0.75 mm² for 50 W output
and a min. of 1 mm² for 100 W output

Connections Terminal screws: max. torque of 0.5 Nm must not be exceeded

Parallel connection
Parallel connection is admissible on the primary side, but is inadmissible on the secondary side

Conductors for low-voltage halogen installations

As the high temperatures associated with the operation of low-voltage halogen lamps place severe demands on lampholder conductors, a skilful combination of conductor and insulation is essential. Tin-plated copper conductors with silicone insulation are recommended for temperatures of up to 180 °C at the cable's conductor; nickel-plated copper cables with polytetrafluoroethylene (PTFE) sheathing are recommended for temperatures of up to 250 °C. Welded connections ensure the most effective heat discharge. Control measurements should be carried out if other connection types are used, e.g. crimping or plug connectors. To prevent the risk of additional heat generation, the maximum permissible current load must be observed when dimensioning the conductor cross-section. When using electromagnetic transformers, the conductor resistance causes a relatively large voltage drop. This drop in voltage is always associated with a reduction of luminous flux. For instance, an 11% drop in voltage will lead to a 30% drop in luminous flux. For this reason, care should be taken to ensure secondary conductors are kept as short as possible and conductor cross-sections are adequately dimensioned when wiring luminaires. Nevertheless, transformers should not be mounted too near the light source (> 25 cm clearance if possible) to prevent the heat generated by the lamp from raising the ambient temperature above the critical level for a transformer.

As electronic converters operate at high frequencies, consideration must be taken of the skin effect, i.e. the displacement of the electrons from the middle of the conductor to its surface. As a result, the full cross-section of the conductor is no longer used, resistance increases and thus leads to a greater drop in voltage. In addition, AC resistance, which is caused by feed line inductance, can result in an even greater voltage drop. It is therefore recommended that lamp conductors be laid closely parallel or twisted together.

Voltage losses (V) with a two-metre secondary conductor

Working frequency	Load W	Cross-section/Voltage drop		
		0.75 mm ²	1 mm ²	1.5 mm ²
50 Hz (electromagnetic transformers) any wiring layout	50	0.38 V	0.29 V	0.2 V
	100	0.74 V	0.56 V	0.39 V
40 kHz (electronic converters) any wiring layout (loops)	50	1.4 V	1.25 V	1.2 V
	100	3.3 V	3.1 V	3 V
40 kHz (electronic converters) wires twisted together or closely parallel	50	0.5 V	0.45 V	0.35 V
	100	1.2 V	1 V	0.85 V

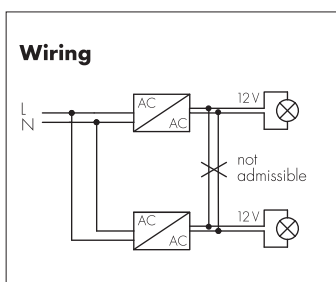

Conductor Contacts

Pin contact Ø 1

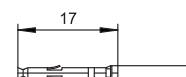

Socket connector

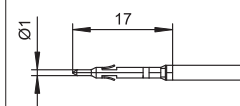

Flat connector 6.3x0.8

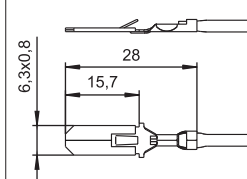

Cable with ferrules

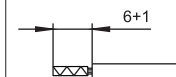

Cable, notched at 6 mm

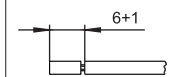

Cable, bared at 6 mm

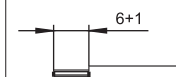

Ultrasonically welded cable end

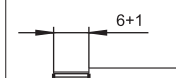

Conductors for installations with halogen lamps

All conductors must be selected to suit the luminaire conditions (see table) in terms of material, cross-section and insulation. Testing these conductors under worst case conditions is essential as the commonly occurring high temperatures considerably reduce the conductivity of the conductor and hence its current-carrying capacity.

Insulation	Conductor Material	Cross-section mm ²	Mains voltage V	Max. temperature °C
SI	Cu tin-plated (Cu vz)	0.75	300	180
FEP	Cu tin-plated (Cu vz)	0.75	300	180
PTFE	Cu nickel-plated (Cu vn)	0.75	500	250
PTFE	Cu nickel-plated (Cu vn)	1	500	250
PTFE	Ni	1	500	250
PTFE	Ni	1.5	500	250

Lampholders

For low-voltage halogen lamps

With the exception of B15d bases, the low-voltage sector is dominated by pin bases, which are fitted with a variety of different pin distances and diameters. Apart from classic lampholders that ensure both the electrical contact and the correct positioning of the lamp, connection elements are also available. These components are solely responsible for establishing electrical contact and are used in cases where, for instance, the regulations demand that the lamp be attached to its reflector (e.g. cold-light reflector lamps with GZ4 and GX5.3 bases). Extremely high temperatures are also generated when operating low-voltage halogen lamps as a result of the tungsten-halogen cycle and high lamp currents. In addition, the respective luminaires are often of very compact design, which leads to heat accumulation and thus to high internal temperatures. The materials the lampholder is made of thus play a vital role for the luminaire's operating safety and the lamp's service life. In addition to tried-and-tested materials – ceramics for casings and mica for covers – ever more frequent use is being made of highly heat-resistant plastics like LCP (liquid crystal polymer for e.g. G4, GU4, GX5.3, GU5.3 and GY6.35 lampholders) and PPS (polyphenylene sulphide for G4 lampholders). Plastic lampholders provide clear advantages: narrow dimensional tolerances, no material fractures, low weight and clip-attachment options.

The type of contact also plays an important role. Conventional contacts are only attached to one side of the lamp pin. In contrast, additional contact points – known as multipoint contacts – lead to a reduction of current density at the point of transition from the lamp pins to the lampholder contact and with that to a decrease in temperature. These contacts provide the further advantage of ensuring superior heat dissipation from the lamp pins to the conductor. The temperature advantage of multipoint contacts in defined conditions (including welded-on conductors) can amount to as much as 100 °C. In extremely rare cases, due to the high internal pressure in the bulb, it is possible for the lamp to shatter. For reasons of fire prevention (high temperature of the glass bulb), the lamp's components must be prevented from falling out. Enclosed luminaires meet these requirements. Open luminaires, however, may only be operated using lamps with enclosed bulbs or low-pressure lamps. Lamps of this kind are suitably marked with pictograms on the lamp's packaging and in the lamp manufacturer's documentation. Lamps marked with pictogram No. 1 are suitable for use with open luminaires, whereas those marked with pictogram No. 2 may only be used in enclosed luminaires.

Lampholders for low-voltage halogen lamps are equipped with mounted cables or with plug-type connectors. In addition to the various lampholders contained in the catalogue, further lampholder models with various cable lengths and of various qualities as well as lampholders with plug-connected cables can be made available on request.

VS lampholders for the UL market and UL approved leads are available for all common lamp types.

Further information can be found at www.unvlt.com.



1



2

Bases of the most widely used low-voltage halogen lamps

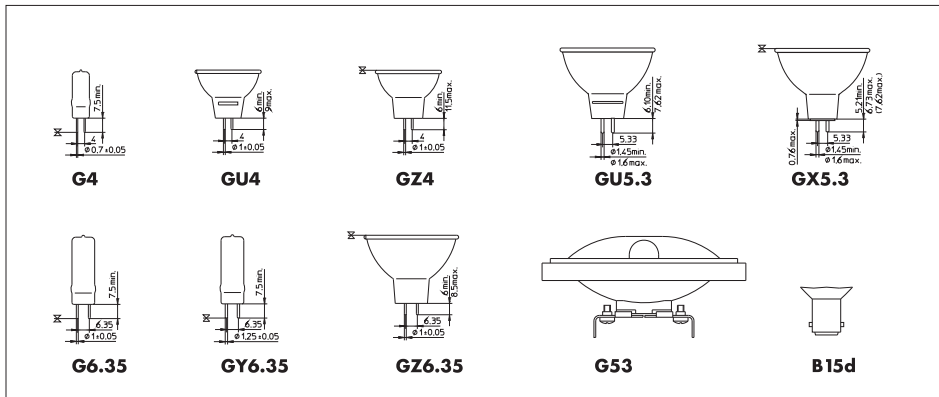

Lampholders for mains voltage halogen lamps

A major factor in lampholder design is the lamp temperature, which is determined by the tungsten-halogen cycle, high lamp current and high wattages. Lampholder casings can be made of ceramics, metal or the ever more popular highly heat-resistant thermoplastics like PET (polyethyleneterephthalate), PPS (polyphenylene sulphide) and LCP (liquid crystal polymer). The most suitable contact materials for these temperatures are nickel, copper-nickel alloys or copper materials with sufficiently thick nickel coatings. For tubular lamps (R7s base), the standard IEC 60061-2 7005-53 prescribes the respective contact pressure of lampholder contact materials.

Although halogen lamps offer twice the service life of general-purpose light bulbs, this can only be fully realised if luminaire manufacturers observe the recommended maximum temperatures at the lamp's pinch point. There is usually a welded-on molybdenum plate at the pinch point where the lamp base pins join the lamp filament. Lamp manufacturers ascertain the pinch temperature at this point, which is generally located within the lamp's quartz glass, using specially prepared measuring lamps. The pinch temperature is a critical thermal reference point which must not be exceeded within the luminaire.

VS lampholders for the UL market and UL approved leads are available for all common lamp types.

Further information can be found at www.unvlt.com.

The bases of the most widely used mains voltage incandescent lamps

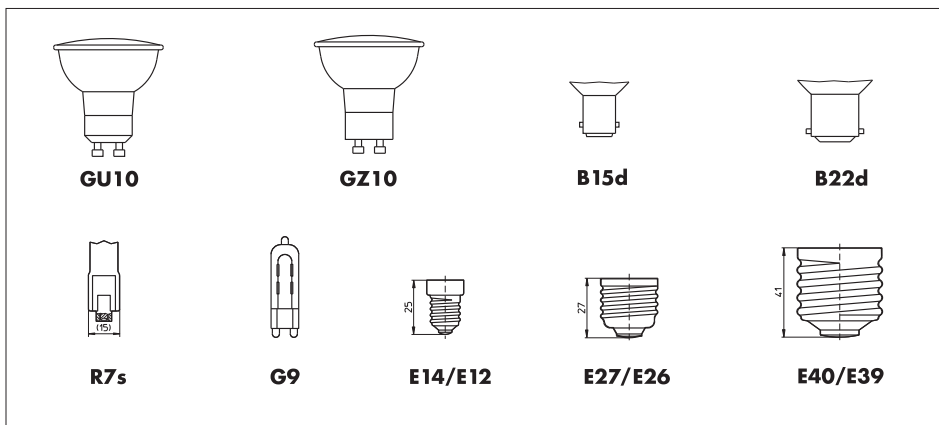

Retrofit Lamps

So-called retrofit lamps have been introduced to the market thanks to LED technology. Some of these can significantly exceed the weight of the original lamp.

When using such lamps in luminaires already introduced to the market (with conventional lampholders), but also for new luminaire designs (with conventional lampholders), this can cause a greater risk with regard to disconnecting the power supply and, in addition, can lead to greater mechanical damage.

1

2

3

4

5

6

7

8

9

10

6–80 W EMERGENCY LIGHTING MODULES



EMERGENCY LIGHTING

Emergency lighting systems spring to life any time normal artificial lighting systems fail. Emergency lighting is designed to ensure that work can continue without risk, that staff can safely leave any workplaces involving special hazards and that there is sufficient lighting to illuminate rescue paths/routes as well as to avoid panic situations.

As power cuts result in a risk to safety, legislation has been enacted in the form of the Health and Safety at Work Directive (Europe) and the Health and Safety at Work Acts of the individual European countries (e.g. Germany), all of which stipulate that emergency lighting must be provided. The requirements placed on emergency lighting installed in places of public assembly and public buildings are governed by supplementary directives and laws.

Vossloh-Schwabe's emergency lighting units are designed for use with T5, T8 and compact fluorescent lamps and can be operated with electromagnetic or electronic ballasts.

VS emergency lighting units are suitable for both continuous and standby circuits with a nominal operating period of 1 or 3 hours.

6

Emergency Lighting Modules for TC and T Lamps

Emergency lighting modules with self-diagnosis function

330-331

Technical details for emergency lighting modules

332-339

General technical details

348-356

Glossary

357-359

1

2

3

4

5

6

7

8

9

10

Emergency Lighting Modules 6 to 80 W with Self-Diagnosis Function

EMXs – Emergency lighting modules

For one-, two-, three- or four-lamp operation with standard and dimmable electronic or magnetic ballasts

EB phase is switched off during emergency operation

Short circuit protection

RoHS-compliant (excluding rechargeable batteries)

5-pin technology and therefore EMC-compliant even during emergency operation

Suitable for protection class I

EN 61347-1, EN 61347-2-7

Suitable for systems in accordance with VDE 0108 or EN 50172

Not suitable for lamps with an integrated starter

Dimensions (LxWxH): 210x31.4x21.5 mm

Fixing hole distance: 205.5 mm

Nominal voltage: 230 V \pm 10%, 50–60 Hz

Ambient temperature t_a : 0 to 50 °C

Unit: 25 pcs.

These VS emergency lighting modules include an automatic self-diagnosis feature that performs a two-minute function test of the device, the lamp and the battery every seven days.

In addition, the operating period is tested every 12 months with subsequent battery reactivation.

Optical status display

- Red LED, flashing intermittently: defective lamp. The status display will be reset approx. one minute after the fault has been rectified.
- White LED, not illuminated: if connected to the power supply, the LED must turn green after a maximum of five minutes. If not, the device either has no voltage supply or the emergency lighting module is defective.
- Red LED, permanently flashing: battery capacity is too low or the battery supply line has been interrupted.
- Green LED: fully functional.



Emergency lighting module

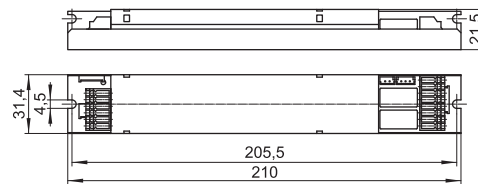

LED

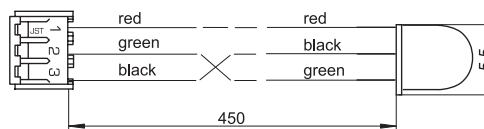

Rechargeable battery

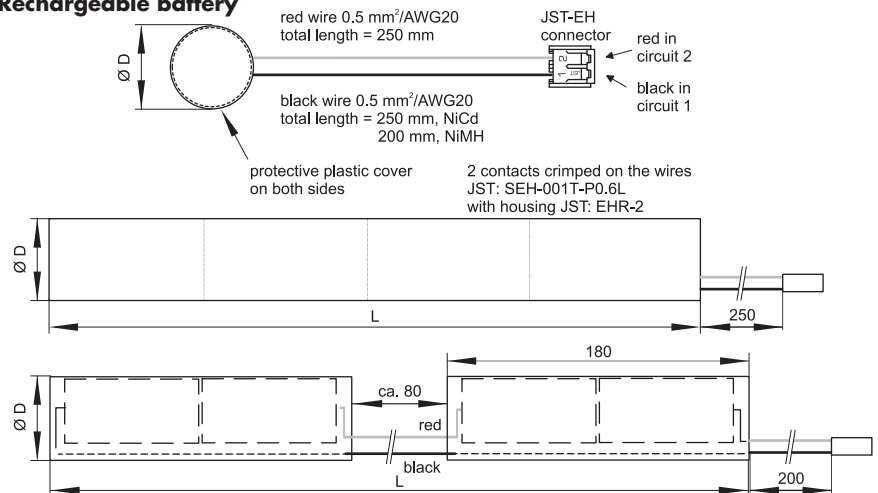

Emergency Lighting Modules 6 to 80 W with Self-Diagnosis Function

EMXs – Emergency lighting modules

Type	Ref. No. Module	Ref. No. Battery	Nominal operating period hrs.	Rechargeable battery type	Dimensions LxD (Ø) of battery mm	Test function	Weight module g	Weight battery g
EMXs 180.000	188792	188823	1	4.8V 1.8Ah NiCd	1 / 190 x 23	automatic	160	200
EMXs 180.001	188793	188824	3	4.8V 4.5Ah NiCd	1 / 240 x 33	automatic	160	490
EMXs 180.002	188794	188825	1	4.8V 1.8Ah NiMH	1 / 200 x 17	automatic	160	140
EMXs 180.003	188795	188826	3	4.8V 4.5Ah NiMH	2 / 450 x 19	automatic	160	320

Circuit diagrams see page 336–338

HOLDERS for Rechargeable Batteries for Emergency Lighting Modules

Material: PC (188828: PBT)

Type: Rechargeable Battery Holder

Ref. No.	For rechargeable battery type	Dimensions (mm)					
		a	b	c	d	e	f
188827	4.8V 1.8Ah NiCd	35.0	18.0	26.3	26.7	13.0	5.5
188828	4.8V 4.5Ah NiCd	39.0	23.2	36.2	37.3	12.4	6.0
188829	4.8V 1.8Ah NiMH	22.5	15.0	22.8	22.5	8.0	4.0
188829	4.8V 4.5Ah NiMH	22.5	15.0	22.8	22.5	8.0	4.0

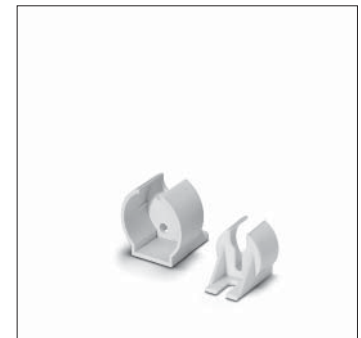
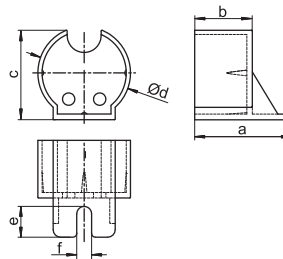

It is recommended to use two holders per rechargeable battery to ensure optimum hold.

Table of suitable lamp types

Lamp type	Lamp nominal output W
T8	15, 18, 32, 36, 58, 70
T5 HE	14, 21, 28, 35
T5 HO	24, 39, 49, 54, 80
T5	6, 8, 13
TR5 (TR16)	22, 40, 55, 60
TR (T29-R)	22, 32, 40
TC-L/TC-F	18, 24, 36, 40, 55, 80
TC-DEL	10, 13, 18, 26
TC-TEL	13, 18, 26, 32, 42, 57, 70
TC-SEL	7, 9, 11
TC-DD (2D)	10, 16, 21, 28, 38, 55

Luminous flux factor of lamps during emergency operation

Lamp nominal output W	Luminous flux factor* %
6	43.0
8	32.0
18	13.0
28	9.0
32	7.0
35	7.0
36	7.0
49	4.7
54	4.3
55	4.7
58	5.2
70	4.3
80	3.7

* Theoretically defined reference values at 25 °C ambient temperature

6

Emergency Lighting Modules for TC and T Lamps

Assembly instructions for emergency lighting modules

333-338

Electrical installation

333-334

Emergency lighting module display

335

Circuit diagrams

336-338

General technical details

348-356

Glossary

357-359

Emergency lighting modules are designed for operation with 6 to 80 W, 4-pin fluorescent lamps. Luminaires with integrated emergency lighting modules can be operated using a continuous or standby circuit.

Technical specifications	EMXs emergency lighting modules
Permissible mains voltage	230 V ±10%
Permissible mains frequency	50–60 Hz
Power consumption with standby circuit	3 W
Nominal period of operation	1 to 3 hours, depending on the type of rechargeable battery
Batteries	NiCd or NiMH
Ambient temperature	0* to 50°C
Charging time	24 hrs
Protection class	1
Degree of protection	IP20
Certification	CENELEC
Tested in accordance with	EN 61347-2-7
Suitable for systems compliant with	VDE 0108 / EN 50172
Casing	Metal (zinc-plated)
Installation outside the luminaire	Permissible lead length between the emergency lighting module and the lamp must not exceed two metres.
Luminous flux factors during emergency operation	See the table on page 331, values apply to 25 °C ambient temperature.

* Ignition in progress; the values of the colour rendering index and the luminous flux factor may deviate.

Assembly Instructions for Emergency Lighting Modules

For mounting and installing of emergency lighting modules

If the emergency lighting module is integrated in the luminaire, the LED and battery have to be wired separately, i.e. not in parallel with the mains or lamp. Emergency lighting modules must be fixed in a suitable spot within the luminaire (4-mm bore holes for mounting).

In the interest of maximising battery capacity and service life, care must be taken to ensure the battery is positioned at the coolest part of the luminaire. The ambient temperature of the battery must not exceed 50 °C. Emergency lighting modules must not be mounted on surfaces that ignite, melt or undergo some other thermal change at a temperature of 60 °C. Moreover, emergency lighting modules must not be operated in explosionendangered enclosed spaces.

Electrical installation

The respective ordinances and standards valid at the place of operation must be observed for installation purposes. Emergency lighting modules and luminaires must only be installed by trained staff. Operating voltages exceed 50 V. Caution: potentially fatal hazard!

Prior to first operation of emergency luminaires, all covers must be attached. Furthermore, care must be taken to ensure that the supply voltage complies with the specifications on the type plate and the protective conductor is connected.

1. Fuse
2. Light switch
3. Room lighting
4. Emergency luminaires

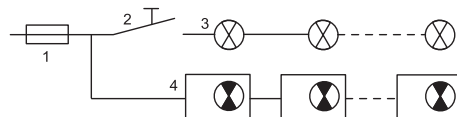

Emergency luminaires must be connected to a direct phase to enable mains monitoring and ensure constant charge retention. This phase must be connected to the group fuse of the regular room luminaire. Emergency luminaires are generally delivered with uncharged batteries and must be connected to the mains for at least 48 hours to be fully functional or for approx. 10 minutes for mains operation in the case of a continuous circuit.

Additional information for optimising EMC

Information on the installation of electronic ballasts for optimising EMC

To ensure good radio interference suppression and the greatest possible operating safety, the following points should be observed when installing electronic ballasts:

- Conductors between the EB and the lamp (HF conductors) must be kept short (reduction of electromagnetic interference). High-potential lamp conductors must be kept as short as possible, in particular with tubular lamps.
Lamp conductors of this kind are labelled with an * in the wiring diagram on the type plate.
- Mains and lamp conductors must be kept separate and if possible should not be laid in parallel to one another. The distance between HF and mains conductors should be as large as possible, ideally > 5 cm.
(This prevents the induction of interference between the mains and lamp conductors.)
- The mains conductor within the luminaire must be kept short (to reduce the induction of interference).
- Devices must be properly earthed. EBs require secure contacts to the luminaire casing or must be earthed using a PE connection. This PE connection should be effected using an independent conductor to achieve better dissipation of the leak current. EMC improves at frequencies greater than 30 MHz.
- The mains conductor must not be laid too close to the EB or the lamp (this is especially important in the event of through-wiring).
- Mains and lamp conductors must not be crossed. Should this be impossible to avoid, conductors should be crossed at right angles to one another to avoid inducing interference between mains and HF conductors.
- Should conductors be wired through metal parts, such conductors must always be additionally shielded (e.g. with an insulating sleeve or grommet).

Maintenance With regard to system maintenance and control, care must be taken to ensure compliance with any ordinances and standards governing emergency lighting at the place of installation. Prior to opening lamp covers, the following procedure must be observed:

1. Disconnect luminaires from the mains voltage.
2. Remove cover.
3. Disconnect battery from the emergency lighting module (disconnect the plug).

VS recommends connecting control LEDs to be visible on the outside of emergency luminaires to enable simple and regular control of emergency luminaires and emergency lighting modules.

Changing batteries

Batteries need to be replaced if the operating period of luminaires falls short of 60 minutes in the case of 1-hour operation and 180 minutes for 3-hour operation, respectively.

Emergency lighting modules have a status display for this purpose.

Spent batteries must be replaced with the manufacturer's original batteries only. Furthermore, the polarity of the batteries must be strictly observed. The battery supply lines of the emergency lighting module are marked as follows:

red = +; black = -

Emergency lighting module display

Normal operation is indicated by a green LED. During emergency operation or for as long as the battery remains fully discharged, the LED is off (i.e. does not glow). The LED will flash red if the battery is missing or not properly connected.

Automatic test of emergency lighting modules

In the case of emergency luminaires with emergency lighting modules, the operational readiness of the device, the lamp and the battery is tested automatically every seven days. In addition, battery capacity is measured during a simulated loss of mains power every 12 months.

The first capacity test will be carried out seven days following initial installation or any repair work. The LED must be checked after the first self-test. A green LED indicates all is in working order, any other display indicates a problem.

The device features a two-colour LED display to indicate that the emergency luminaire is ready for use.

Optical status display

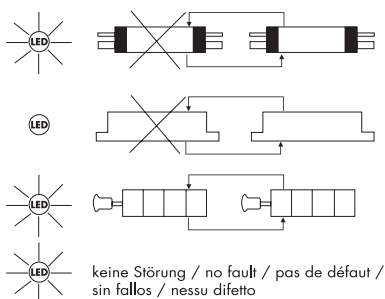

Emergency luminaires merely require regular visual inspection of the status display (LED) and the luminaire itself.

Red LED, flashing intermittently	During initial operation, a lamp recognition test is first carried out. Prior to and during this test, the LED will be red and flash intermittently.
White LED, not illuminated	If connected to mains power, the LED must turn green after a maximum of five minutes. If not, the device has no mains voltage or the emergency lighting module is defective.
Red LED, continuous flashing	Battery capacity is too low or the battery supply line has been interrupted. The warning light will go off again as soon as the problem has been rectified.
Green LED	Fully functional.

Notes

Vossloh-Schwabe accepts no liability for any direct, indirect or incidental damage caused by putting a device to any improper use, i.e. any use not expressly permitted by VS. Similarly, Vossloh-Schwabe accepts no liability for third-party claims arising from putting a device to any improper use, i.e. any use not expressly permitted by VS. Emergency lighting modules must not be opened or modified in any way. The components of emergency lighting modules must be replaced with original parts only.

Should emergency lighting modules be damaged in a way that suggests it cannot be operated safely, the luminaires or emergency lighting modules, respectively, must not be operated. VS reserves the right to make changes to diagrams, weights, tables of dimensions or other such details included in the catalogue or instructions for use without prior notice if such changes prove to be necessary or are made as a result of technological progress. VS emergency lighting modules are patent protected.

Any act of producing counterfeit VS products will be prosecuted according to criminal and civil law.

Caution!

Emergency lighting modules from VS must not be operated with amalgam lamps.

1

2

3

4

5

6

7

8

9

10

Circuit Diagrams

For VS emergency lighting modules

Notes for wiring:

- The distance between mains lead and lead 8 should be as large as possible
- Leads 2/4/6/8 must be kept short

Circuit diagrams – 1-lamp operation

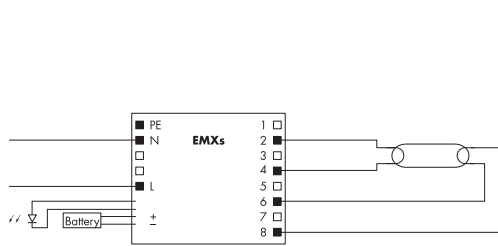

1-lamp operation without electronic or electromagnetic ballast (continuous circuits)

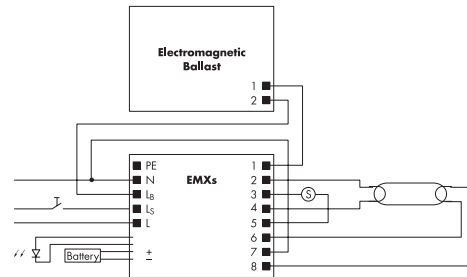

1-lamp operation with electromagnetic ballast

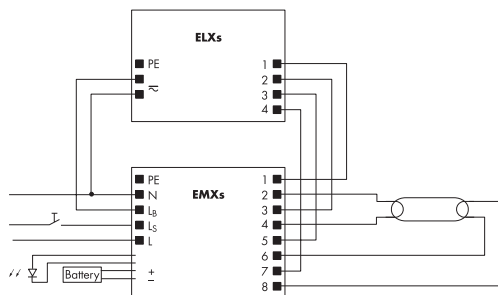

1-lamp operation – Warm start with electronic ballast ELXs

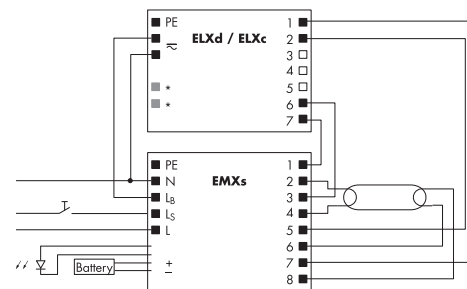

*nur bei dimmbaren Vorschaltgeräten/only with dimmable ballasts/juste avec ballasts graduables/solo con alimentatori dimmerabili/solo con reattanza regolabile

1-lamp operation – Dimming / Warm start with electronic ballast ELXd / ELXc

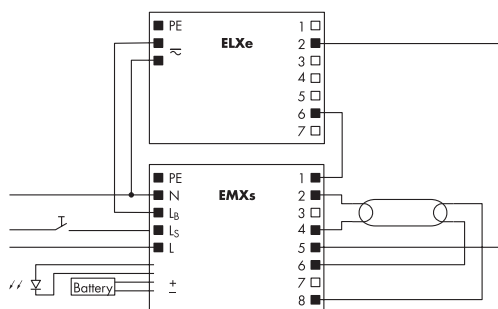

1-lamp operation – Instant start with electronic ballast ELXe

Circuit diagrams – 2-lamp operation

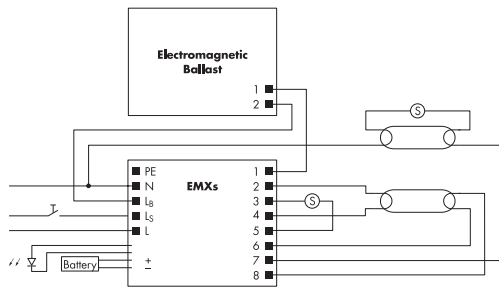

2-lamp operation with electromagnetic ballast

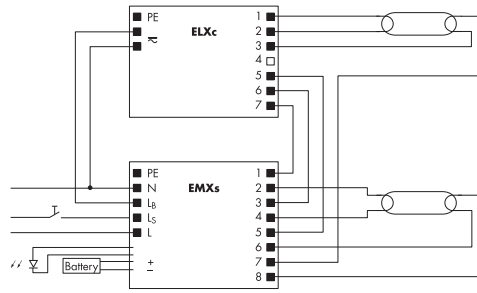

2-lamp operation – Warm start with electronic ballast ELXc

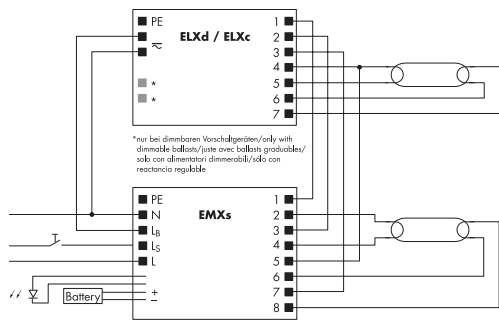

2-lamp operation – Dimming / Warm start with electronic ballast ELXd / ELXc

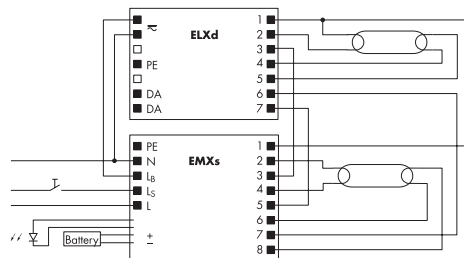

2-lamp operation – Dimming with electronic ballast ELXd

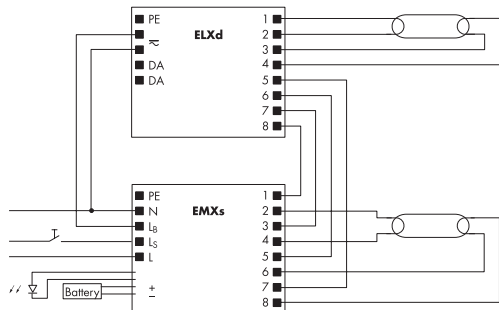

2-lamp operation – Dimming with electronic ballast ELXd

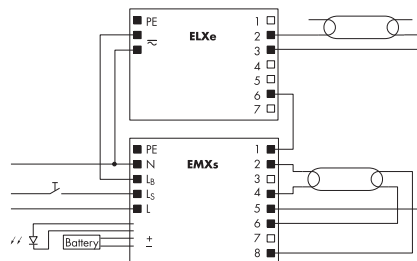

2-lamp operation – Instant start with electronic ballast ELXe

Circuit diagrams – 3-lamp operation

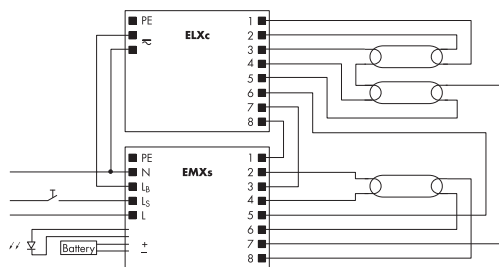

3-lamp operation – Warm start with electronic ballast ELXc

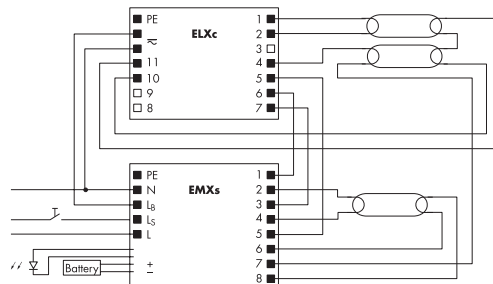

3-lamp operation – Warm start with electronic ballast ELXc

1

2

3

4

5

6

7

8

9

10

Circuit diagrams – 3-lamp operation

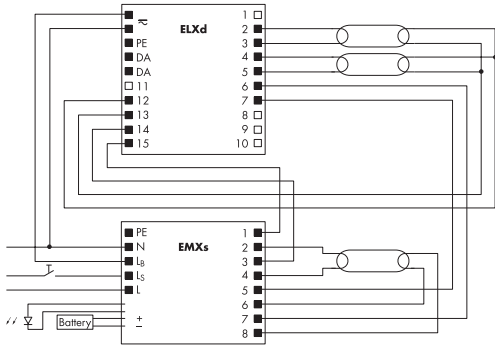

3-lamp operation – Dimming with electronic ballast ELXd

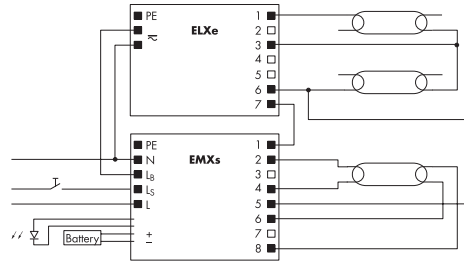

3-lamp operation – Instant start with electronic ballast ELXe

Circuit diagrams – 4-lamp operation

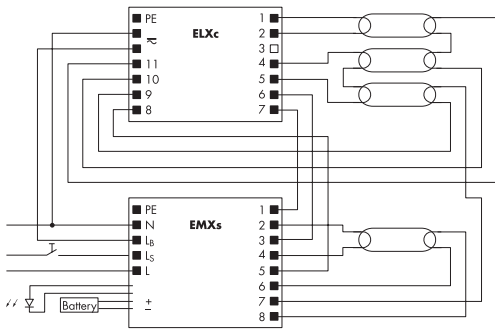

4-lamp operation – Warm start with electronic ballast ELXc

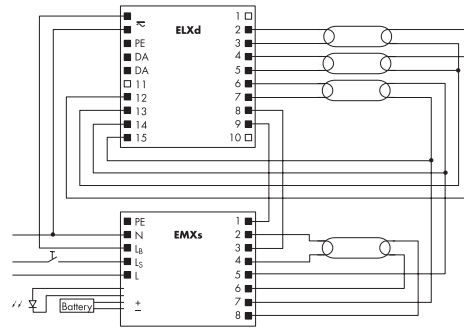

4-lamp operation – Dimming with electronic ballast ELXd

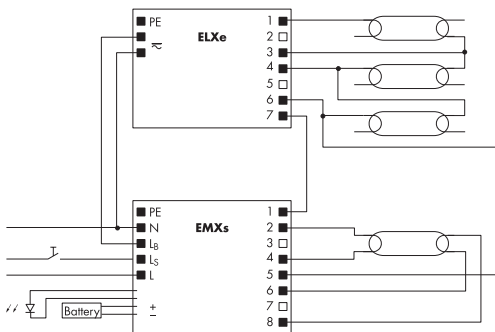

4-lamp operation – Instant start with electronic ballast ELXe

1

2

3

4

5

6

7

8

9

10

LIGHTING TECHNOLOGY COMPONENTS FOR THE UL MARKET

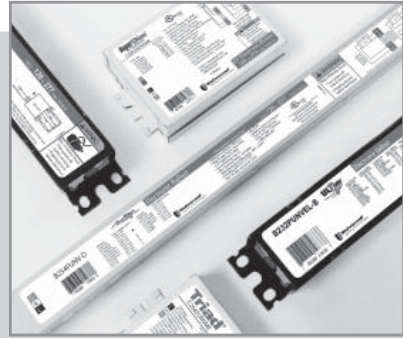

At the beginning of 2010, the US American sales office, Vossloh-Schwabe Inc., was merged with Universal Lighting Technologies, Inc., a further Panasonic subsidiary.

Universal Lighting Technologies, Inc., produces some of the world's most advanced linear fluorescent, compact fluorescent, HID, eHID, and LED solutions for commercial lighting applications.

The following pages serve to give you some idea of the highly extensive product range of VS lampholders for the UL market.

A global leader in research and development since 1947, Universal proudly features recognized and trusted brands like Universal® and Triad®, with a reputation for innovations that can significantly reduce energy costs with high efficiency solutions, installer-friendly options, and greater flexibility for fixture designs.

Advanced lighting technologies such as step-dimming, 0–10 V analog dimming, DALI dimming and energy management systems help meet specific application and user requirements.

The EVERLINE® brand of LED products leads the industry on performance, flexibility and quality. Whether developed individually or to be part of a system, EVERLINE makes it easy to configure a full featured, high efficiency LED system.

Further information can be found at www.unvlt.com.



Nashville, TN 37214
Phone: 615-316-5100
www.unvlt.com

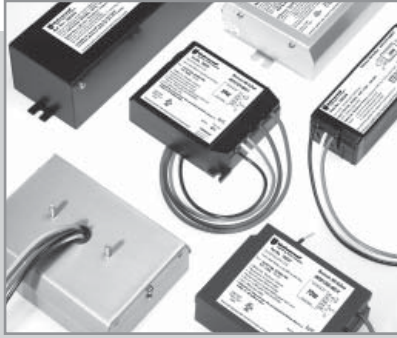

1

2

3

4

5

6

7

8

9

10



Energy Management & Controllable Lighting



Linear Fluorescent Ballasts



Electronic & Magnetic HID Ballasts

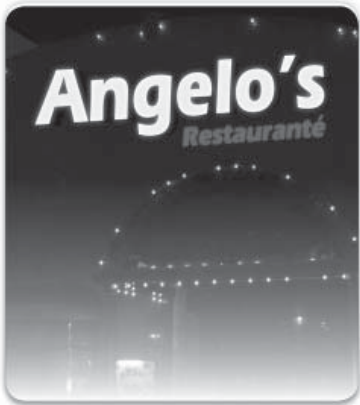

Sign Ballasts



Compact Fluorescent Ballasts



LED Systems

E39 Porcelain Lampholders

For discharge lamps with base E39 / Mogul base

Screw terminals: max. 16-12 AWG, solid conductor

E39 lampholders

Casing: porcelain, white

Nominal rating: 2000 W/600 V/6 kV pulse rating

Cylindric shape

Screw shell: brass, nickel-plated

Central contact: brass, nickel-plated

Spring loaded central contact

Screw terminals: 18-14 AWG

Fixing distance: 35 mm (1.378")

Thread measured in inches No. 8-32 UNC (ISO)

Weight: 190 g, unit: 50 pcs.

Type: 12870/12876

Ref. No.: 109014

Ref. No.: 109518 with lamp safety catch

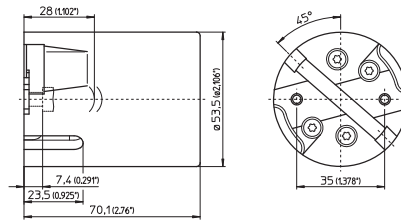

GU6.5 Lampholders

For single-ended discharge lamps

Additional lead lengths and types on request

GU6.5 lampholders

Casing: ceramic, cover plate: PPS

Nominal rating: 2 A/250 V/5 kV pulse rating

Leads: Cu nickel-plated, stranded conductors 18 AWG,
PTFE-insulation, length: 305 mm (12")

Weight: 20 g, unit: 100 pcs.

Type: 34515 fixing holes for screws M3 (#4)

Ref. No.: 534218

Type: 34516 threaded bushes for screws M3 (#4)

Ref. No.: 534219

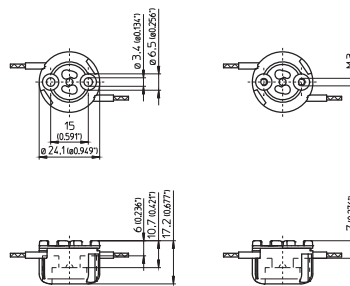

GU6.5 lampholders

Casing: ceramic, cover plate: PPS

Nominal rating: 2 A/250 V/5 kV pulse rating

Leads: Cu nickel-plated, stranded conductors 18 AWG,
PTFE-insulation, length: 305 mm (12")

Weight: 20 g, unit: 100 pcs.

Type: 34525 dia. 22 mm

Ref. No.: 535783

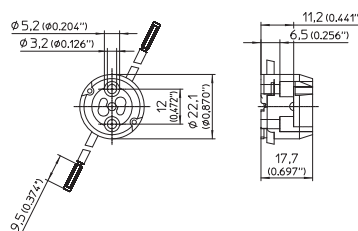

GX10 Lampholders

For single-ended discharge lamps

GX10 lampholder

Casing: steatite, cover plate: PPS

Nominal rating: 2/500/5 kV

Leads: Cu nickel-plated, stranded conductors

18AWG, PTFE insulation, length: 305 mm (12")

Weight: 25 g, unit: 100 pcs.

Type: 31550

Ref. No.: 543153

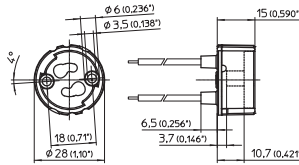

1

2

3

4

2G11 Lampholders for Twin-tube 4-pin Lamps

For Single-ended Compact Fluorescent Twin-tube 4-pin Lamps

Nominal rating: 660W/600V

Degree of protection: IP20

2G11 back panel or bracket mount lampholders

Casing: PBT GF, white

Lateral pivots for bracket

Rear mounting holes for self-tapping #8 screws

Front mounting holes for #4 screws (M3)

Weight: 12.7 g, unit: 500 pcs.

Type: 36051

Ref. No.: 101489

Quick-connect twin terminals: 18AWG solid or stranded solder-dipped (lamp circuit)
Quick-connect terminals: 18AWG solid or stranded solder-dipped (starter circuit)

All products in this chapter carry a T rating of T120 acc. to UL standards (shunted versions correspond to Circle-I requirements).

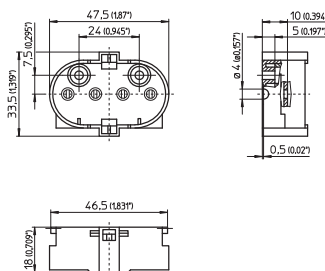

5

6

7

8

9

10

G24 Lampholders for Quad-tube Lamps, GX24 Lampholders for Triple-tube Lamps

For Single-ended Compact Fluorescent Bi-pin and 4-pin Lamps

The drawings and photos contained in this chapter only show lampholders for lamps with base G24d-1.
All T ratings in this chapter refer to IEC standards

When mounting lampholder remember triple-tube GX24d/GX24q lamps are wider than lampholder.
When using central-mounting hole provisions must be made to prevent lampholder rotation.

All lampholders with quick-connect terminals (UL File No. E110363): 18AWG solid or stranded solder-dipped

G24, GX24 snap-in lampholders
Casing: PBT GF, white, T140 (acc. to IEC)
Nominal rating: 660 W/600 V
Quick-connect twin terminals: 18AWG (lamp circuit)
For G24q, GX24q lampholders:
quick-connect terminals: 18AWG (starter circuit)
Rear split pins for wall thickness
0.8–1.7 mm (0.031–0.067")
Width of split pin: 4.5 mm (0.177")

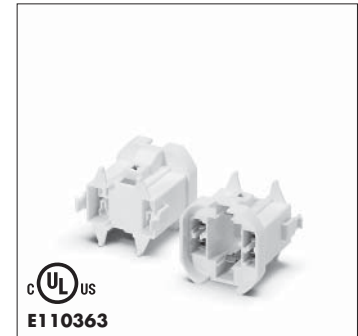
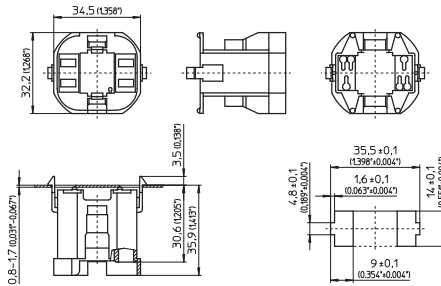

Type	Ref. No.	Base	Output (W)	Weight (g)	Unit (pcs.)
72101	528116	G24d-1/GX24d-1	8, 10, 13 / 13	10.4	500
72102	528117	G24d-2/GX24d-2	18 / 18	10.4	500
72103	528118	G24d-3/GX24d-3	26 / 26	10.4	500
72111	528120	G24q-1/GX24q-1	10, 13 / 13	12.3	500
72112	528121	G24q-2/GX24q-2	18 / 18	12.3	500
72113	528122	G24q-3/GX24q-3	26 / 26, 32	12.3	500
72119	528126	GX24q-3/-4*	26, 32 / 42	12.3	500
72114	528123	GX24q-4	42	12.3	500
72115	528124	GX24q-5	57	12.9	500
72116	528125	GX24q-6	70	12.9	500

Shunted Version

72111	528128	G24q-1/GX24q-1	10, 13 / 13	12.3	500
72112	528129	G24q-2/GX24q-2	18 / 18	12.3	500
72113	528130	G24q-3/GX24q-3	26 / 26, 32	12.3	500
72119	528134	GX24q-3/-4*	26, 32 / 42	12.3	500
72114	528131	GX24q-4	42	12.3	500
72115	528132	GX24q-5	57	12.9	500
72116	528133	GX24q-6	70	12.9	500

* Lampholders 528126 and 528134 may only be used in luminaires that are operated with electronic ballasts that have been certified according to the applicable standards and that cover the luminaire performance range of 26, 32 and 42W.

G13 Push-through Lampholders for T8, T12 Lamps

Lampholders for fluorescent lamps T8 and T12 / Medium Bi-Pin

Nominal rating: 660 W/600 V
 Push-in twin terminals: 18 AWG, solid or stranded conductors, tinned
 Lateral fixing clips for wall thickness 0.4–2 mm (0.016"–0.079")

Casing: PC, white
 (shunted versions: PBT, white)
 Front plate: PBT GF, white

All products in this chapter carry a T rating of T120 acc. to UL standards (shunted versions correspond to Circle-I requirements).

G13 push-through lampholders for lamps T8, T12

Pin support for reliable contact

Lamp axis: 17 mm (0.67")

Weight: 5,4 g, unit: 1000 pcs.

Type: 26300/26302 with stop

Ref. No.: 551271

Ref. No.: 551275 internally shunted

Type: 26310/26312 without stop

Ref. No.: 551272

Ref. No.: 551277 internally shunted

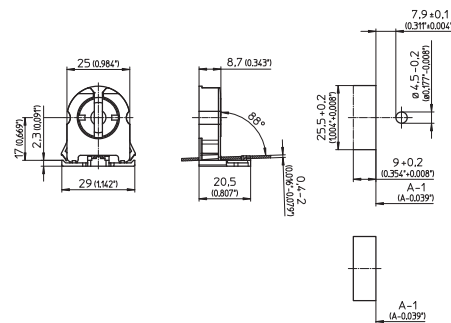

G13 push-through lampholders for lamps T8, T12

Pin support for reliable contact

Lamp axis: 23 mm (0.906")

Weight: 6.6 g, unit: 1000 pcs.

Type: 29100/29125 with stop

Ref. No.: 545845

Ref. No.: 545840 internally shunted

Type: 29101/29126 without stop

Ref. No.: 545849

Ref. No.: 545842 internally shunted

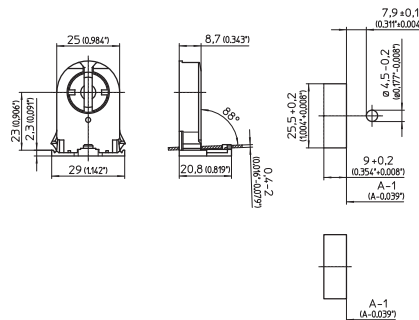

G13 push-through lampholders for lamps T8, T12

Pin support for reliable contact

Lamp axis: 31 mm (1.220")

Weight: 7.8 g, unit: 1000 pcs.

Type: 28700/28725 with stop

Ref. No.: 109342

Ref. No.: 109376 internally shunted

Type: 28701/28726 without stop

Ref. No.: 109343

Ref. No.: 109377 internally shunted

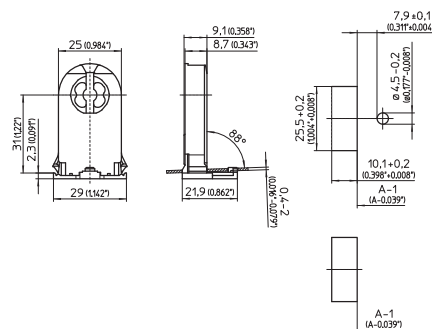

1

2

3

4

5

6

7

8

9

10

G5 Lampholders

Lampholders for fluorescent lamps with base G5

Nominal rating: 120 W/600 V
 Push-in twin terminals: 18 AWG, solid or stranded conductors, tinned
 Lateral fixing clips for wall thickness 0.5–1.5 mm (0.020"–0.059")

All products in this chapter carry a T rating of T120 acc. to UL standards (shunted versions correspond to Circle-I requirements).

G5 push-through lampholders
 Lamp axis: 20 mm (0.787")
 Casing: PBT GF/PC, white, rotor: PBT GF, white
 Weight: 4.1 g, unit: 1000 pcs.
 Type: 09432/09433
Ref. No.: 545933 with stop
Ref. No.: 545935 without stop

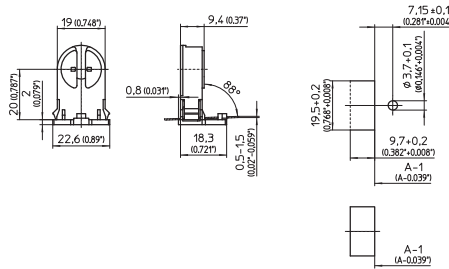

G5 push-through lampholders
 Lamp axis: 25 mm (0.984")
 Casing: PBT GF/PC, white, rotor: PBT GF, white
 T140, nominal rating: 2/500
 Weight: 4.5 g, unit: 1000 pcs.
 Type: 09434/09435
Ref. No.: 545937 with stop
Ref. No.: 545939 without stop

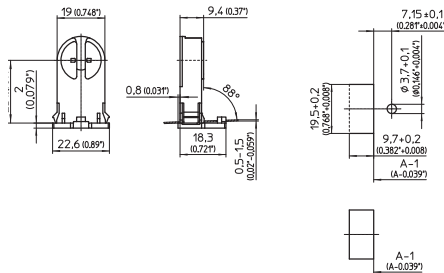

G5 push-through lampholders
 Lamp axis: 15 mm (0.591")
 Casing: PBT GF/PC, white, rotor: PBT GF, white
 Weight: 3.5 g, unit: 1000 pcs.
 Type: 09420/09421
Ref. No.: 505737 with stop
Ref. No.: 505739 without stop

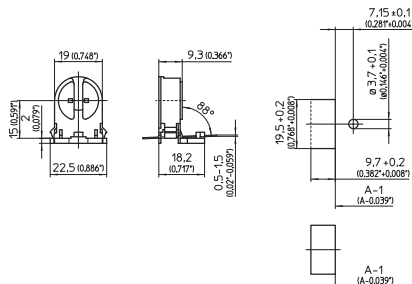

1

2

3

4

5

6

7

8

9

10

8

General Technical Details

General technical details	349–356
Product development and product certification	349–350
CE mark	350
Climate and environmental protection	352
Protection classes of luminaires and operating devices	353
Operating devices with double or reinforced insulation for installation in protection class II luminaires	353–354
Protection classes of luminaires and operating devices	355
Selection of components, materials and dimensions	356
Impulse voltage categories for lampholders	356
Torque to be applied to screws	356
Glossary	357–359

Product development and product certification

The increasingly converging world and the global markets that are being created are both placing new design demands on the sector and its technologies. Against this background, standardisation – both on a regional and international scale – is becoming more and more important in positioning new technologies and innovations on the market. Standardisation ensures the necessary degree of safety, reliability, exchangeability and cost-effectiveness.

Vossloh-Schwabe products have been developed and produced on the basis of technical innovations, internationally and regionally applicable standards and valid environmental regulations for more than 90 years. In this respect, we already take account of integrated components and materials, production methods and technologies, comprehensive environmental aspects as well as a product's energy efficiency during the development phase. An important entrepreneurial goal in all these years has been and continues to be to create lighting components that satisfy the requirements of our customers with regard to safety, function, longevity and cost-effectiveness.

In addition to observing valid, state-of-the-art standards, we also take consideration of the recommendations of industrial associations when developing new products.

Our cooperation in national and international committees ensures we receive early information about new or changed regulations and thus helps to guarantee future-orientated products.

In addition to undergoing internal production approval tests, mass-produced devices are also submitted to national and international testing institutes for certification. The applicable testing and assessment regulations of the testing institutes are subject to international variation. The marks of conformity shown here are therefore not valid for all the products featured in the catalogue. You will find an overview of the approval marks for the products presented in the catalogue from page 360 on. On request, we will gladly provide information about all of the existing approvals. You can also find test certificates in our online catalogue at www.vossloh-schwabe.com.

As the international IEC (International Electrotechnical Commission) standards for lighting technology are also adopted by the European Institute for Standardisation CENELEC (Comité Européen de Normalisation Electrotechnique), the European standards (EN) therefore contain the same requirements. In rare cases, national deviations are permitted. The certification (third-party testing) of VS catalogue products in accordance with EN standards is documented by the ENEC mark.

The ENEC mark (European Norms of Electrical Certification) was created in Europe as a uniform certification mark for electrotechnical products. The ENEC Agreement currently governs the following product groups:

- luminaires
- luminaire components
- energy-saving lamps
- IT equipment
- connection terminals, clips
- capacitors
- couplers
- switches for household appliances
- noise filters
- safety transformers
- tools
- consumer electronic
- batteries
- domestic appliance
- mobile tools
- IT products

There are plans to include further electrical equipment in the ENEC Agreement.

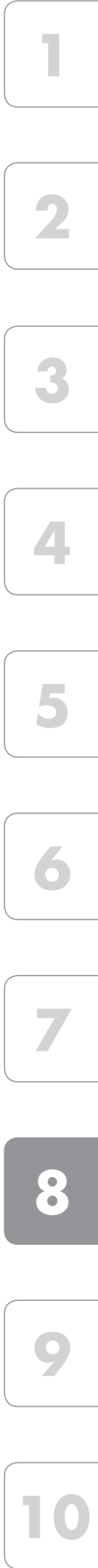

General Technical Details

The certification of products is also expanded to include non-European manufacturers. However, certification testing for lighting equipment must be carried out by an ENEC testing institute in Europe.

At present, a total of 24 testing houses in 20 countries are signatories of the ENEC agreement (see table). Obtaining an ENEC mark for luminaire components like ballasts and ignitors also includes having the product assessed in accordance with the standards governing safety and function. Certification must be based on the EN standards listed in the Agreement. The mark documents that the product not only complies with the applicable standards, but also that ongoing production is monitored by inspectors from a testing institute and that the manufacturer operates an effective quality assurance system in accordance with the ISO 9000 standard suite (International Standards Organisation). ISO deals with the standardisation of non-electrotechnical products.

The ENEC mark is displayed with the identification number and often the logo of the testing institute, as follows:

Identification No.	Testing Institute	Identification No.	Testing Institute
01	AENOR – Spain	16	SGS Fimko – Finland
02	SGS – Belgium	17	NEMKO – Norway
03	IMQ – Italy	18	TRI MEEI – Hungary
04	CERTIF – Portugal	19	ITCL – United Kingdom
05	DEKRA – Netherlands	21	EZÚ – Czech Republic
08	LCIE – France	22	SIQ – Slovenia
09	MIR-TEC – Greece	23	TSE – Turkey
10	VDE – Germany	24	TRLPTÜV – Germany
11	ÖVE – Austria	25	TÜV SÜD PS – Germany
12	BSI – United Kingdom	28	SEP – BBJ – Poland
13	Electrosuisse – Switzerland	30	PREDOM – OBR – Poland
14	Intertek SEMKO – Sweden		EVPU – Slovakia
15	UL Int'l DEMKO – Denmark		

Apart from a product's safety and performance certification, a further useful selection aid is to have a product's electromagnetic compatibility (EMC) tested by an independent test institute, particularly in the case of electronic ballasts. If the product passes the EMC test, an additional test mark is awarded, for instance the VDE EMC mark of the VDE test and certification institute in Offenbach. The EMC certifications for control gears are helpful for the EMC luminaire certification and could reduce time and cost for the luminaire certification.

CE mark

EC Directives form the basis for a common European domestic market without any trade restrictions. Any products that are destined for the European market have to meet the requirements of all directives that apply to the product in question. Compliance with the directives is documented by the CE mark on the product or in the technical documents.

This CE mark is therefore not a mark of compliance with standards (test certificate) of a testing institute, like the ENEC mark is, and can therefore not be issued by a testing institute. The CE mark must be printed on the product, the packaging or both and is not directed at the consumer, but at supervisory authorities.



The following table contains a list of key EC Directives governing lighting:

2015/1428/EC	Directive dated 25 August 2015 that amends Directive (EC) No. 244/2009 of the Commission with regard to laying down requirements for the eco-friendly design of households lamps with unbundled light and Directive (EC) No. 245/2009 of the Commission with regard to laying down requirements for the eco-friendly design of fluorescent lamps without a built-in ballast, high-pressure discharge lamps as well as ballasts and luminaires for their operation and for annulling Directive 2000/55/EC of the European Parliament and the Committee and Directive (EU) No. 1194/2012 of the Commission with regard to the eco-friendly design of lamps with bundled light, LED lamps and associated devices.
2014/53/EC	Requirements for radio equipment (luminaires with built-in transmitters) dated 16 April 2014 governing the harmonisation of legal regulations on retailing radio equipment on the market and to render Directive 1999/5/EC invalid.
2014/35/EC	Electrical equipment designed for use within certain voltage limits (Low Voltage Directive); valid from 20.04.2016
2014/30/EC	Directive on the harmonisation of the laws of the Member States relating to electromagnetic compatibility; national laws had to take effect by 20.01.2007. Applicable to new products since 20.07.2007. (EMC Directive); valid from 20.04.2016
2012/19/EU	Directive governing the recycling of used electric and electronic devices (WEEE Directive)
2012/27/EU	Energy efficiency directive that amends Directives 2009/125/EC as well as 2010/30/EU and renders Directives 2004/8/EC and 2006/32/EC invalid
1194/2012/EC	Ecodesign requirements for directional lamps, light emitting diode lamps and related equipment
874/2012/EC	Energy labelling of electrical lamps and luminaires
2011/65/EC	Restrictions governing the use of certain hazardous substances in electrical and electronic devices. On 3 January 2015, the 2011/65/EU (RoHS 2) Directive superseded the previous 2002/95/EC (RoHS 1) Directive. Both directives are unofficially shortened to RoHS (Restriction of Hazardous Substances).
347/2010/EC	Ecodesign requirements for fluorescent lamps without an integrated ballast, for high intensity discharge lamps, and for ballasts and luminaires able to operate such lamps
2010/31/EC	Directive governing the total energy efficiency of buildings
2010/30/EC	Indication by labelling and standard product information of the consumption of energy and other resources by energy-related products (this directive supersedes directive 98/11/EC)
859/2009/EC	Ecodesign requirements on ultraviolet radiation of non-directional household lamps
245/2009/EC	Definition of eco-design requirements regarding fluorescent lamps without an integrated ballast, high-pressure discharge lamps as well as ballasts and luminaires in their operation and the invalidation of Directive 2000/55/EC of the European Parliament and Council.
244/2009/EC	Definition of eco-design requirements regarding household lamps with non-directional light.
2009/125/EC	Setting of eco-design requirements for energy-related products (ErP). This directive supersedes directive 2005/32/EC. The new directive was extended and now includes all energy-consuming products. Regulations 244 and 245 remain unaffected by this change.
1907/2006/EC	Specifications governing the registration, evaluation, authorisation and description of chemicals: REACH (Registration, Evaluation, Authorisation and Restriction of Chemical Substances) plus amending regulations; e.g. 348/2013/EC, latest amendment of the REACH regulation
2006/95/EC	Electrical equipment designed for use within certain voltage limits (Low Voltage Directive); valid till 19.04.2016
2006/32/EC	Energy end-use efficiency and energy services â " ES Directive (Energy Service); national laws must take effect by 17.05.2008.
2006/25/EC	Directive on the minimum health and safety requirements regarding the exposure of workers arising from physical agents (artificial optical radiation)
2005/32/EC	Eco-design requirements for energy-using products â " EuP directive (Energy using Products).
2005/20/EC	Directive regarding packaging
2004/108/EC	Directive on the approximation of the laws of the Member States relating to electromagnetic compatibility; national laws had to take effect by 20.01.2007. Applicable to new products since 20.07.2007. (EMC Directive); valid till 19.04.2016
2004/40/EC	Directive on the minimum health and safety requirements regarding the exposure to the risks arising from physical agents (electromagnetic fields)
2004/12/EC	Directive on packaging
2003/66/EC	Directive on energy labelling of household electrical refrigerators, freezers and lamps
2002/96/EC	Old electrical and electronic devices; effective since 13.08.2005; does not fall under the CE mark directive
2002/91/EC	Total energy efficiency of buildings; effective since 04.01.2006; does not fall under the CE mark directive
2001/95/EC	Directive on general product safety
1999/05/EC	Requirements for radio-controlled systems and telecommunications equipment as well as reciprocal acknowledgement of their conformity (R&TTE = Radio Equipment and Telecommunications Terminal Equipment) dated 9 March 1999. Also applies to luminaires with built-in transmitters.
1998/11/EC	Energy rating of household lamps; effective since 14.06.1999
1994/62/EC	Directive on packaging
93/68/EWC	CE marking directive

1

2

3

4

5

6

7

8

9

10

Manufacturers are obliged to keep conformity declarations as well as test and production documentation ready for presentation.

The documents must be retained for a period of 10 years after the product was last marketed.

Vossloh-Schwabe operating devices all bear the CE mark; the respective conformity declaration and production documentation are available for inspection. As a consequence, all luminaires that are equipped with properly installed VS components and for which the assembly instructions were observed meet the legal requirements.

Climate and environmental protection

The European Union adopted a number of EU Directives that are designed to reduce the CO₂ output. Essentially, these objectives can be grouped into three categories:

- requirements placed on new products,
- requirements placed on buildings and
- revision of existing installations.

The requirements placed on new products are governed by the **ErP framework directive** (**E**nergy-related **P**roducts) together with the so-called implementation directives, which envisage the setting of special energy requirements for lamps (minimum lm/W requirements), operating devices (minimum efficiency ratings) and luminaires (minimum energy efficiency requirements) for all lighting technologies.

The directive on energy efficiency requirements regarding ballasts for fluorescent lamps is integrated into the implementation directives.

The requirements for buildings (**EPBD: E**nergy **P**erformance of **B**uildings) specify targets for the maximum permissible primary output of lighting. In so doing, a calculation method is employed that will stipulate the permissible maximum electrical output values of the lighting system using a reference procedure.

With regard to the revision of existing installations the EU member states are called upon to set up national action plans (**Energy Service Directive**) that show which measures can be used to achieve the targeted CO₂ reductions.

In addition to the climate protection requirements, a number of directives were also produced to cover waste reduction and recycling, specifically the **WEEE** (**W**aste of **E**lectrical and **E**lectronic **E**quipment) and **RoHS** (**R**estriction of the use of certain **H**azardous **S**ubstances) directives. These directives regulate the disposal and reduction of waste and the use of hazardous substances.

As a result of the REACH system (**R**egistration, **E**valuation, **A**uthorisation and Restriction of **C**hemical Substances) only registered chemical substances can now be brought onto the market. The principle is: no data, no market.

As operating devices and lampholders are constituent parts of luminaires, these components are to be disposed of along with the luminaire; separate disposal is not provided for.

Protection classes of luminaires and operating devices

The electric shock protection that luminaires and control gears are fitted with provides dual protection, which prevents any danger in the event of a technical defect. With regard to safety, the simultaneous occurrence of two errors can be taken into account in certain circumstances, e.g. given a street luminaire with two lamp casings, one of which is used to house the ballast that operates the lamp. This also applies to low-voltage LED lighting systems.

Luminaires and operating devices of **protection class I** provide protection against electrical shock solely using the base insulation and the safe connection of all exposed conductive parts to an earth conductor. Thus, should the base insulation fail, no exposed conductive parts can become live.

Luminaires and operating devices of **protection class II** provide protection against electrical shock using both the base insulation and an additional or reinforced insulation. Protection class II products do not feature a connection to a protective earth conductor. The mounting conditions do not ensure any additional degree of protection, either.

In special cases with Protection Class II luminaires, it can be permissible to connect a protective conductor or a function protection conductor, as follows:

- **for EMC reasons** – in such cases, it can be necessary to connect a function protection conductor to remain within EMC limiting values. The component manufacturer's specifications regarding the individual operating devices must be observed during the construction of the luminaire. If an operating device is marked as containing a function protection conductor, the creepage and air clearance distances of the operating device connection must comply with the requirements of protection class II (reinforced or additional insulation);
- **as an ignition aid for lamps** – connecting a function protection conductor can be necessary as a capacitive ignition aid for lamps. In such cases the creepage and air clearance distances around the ignition aid within the luminaire and the function protection conductor connection terminal have to comply with the requirements of protection class II (reinforced or additional insulation). The ignition behaviour of a lamp should be agreed with the manufacturer in these cases;
- **when wiring the protective conductor** from the luminaire to another device. This is an installation point of the protective conductor and creepage and air clearances must comply with the respective requirements laid down in the luminaire standard as well as any requirements regarding reinforced or additional insulation.
Functional earth connections of control gear or Protection Class II luminaires must always feature double or reinforced insulation since no technical safety requirements exist for functional earth.

Operating devices with double or reinforced insulation for installation in protection class II luminaires

Protection class II specifications have to be met by the luminaire along with its installed operating device. Both protection class I and class II ballasts can be installed. The design of the luminaire must be adapted to suit. This means that if a protection class I ballast is installed in a protection class II luminaire, the design of the luminaire has to be correspondingly sophisticated to ensure the creepage and air clearance distances can be met. On the other hand, using a protection class II ballast, only available as an independent ballast nowadays, will in most cases result in a need for too much technical effort and thus in high costs. Against this background, the standards contain special requirements for ballasts destined for installation in protection class II luminaires.

These "**double or reinforced insulation ballasts**" and respective protection class II lampholders permit technically and cost-effective construction of protection class II luminaires.



Connection terminal for the protective earth conductor
Protection class I



Connection of the function protection conductor
(will drop in future)



General symbol for an earth connection



Protection class II



Ballasts with double or reinforced insulation



Protection class III

1

2

3

4

5

6

7

8

9

10

Protection class III luminaires provide protection against electrical shock by using Safety Extra Low Voltage (SELV). Luminaires of protection class III are not permitted to generate higher voltages than the Safety Extra Low Voltage (SELV).

The following table (X1), which has been taken from the luminaire standard EN 60598-1, provides an overview of the insulation coordination between the various types of built-in electronic ballasts and the types of insulation found in luminaires.

Operating gear		Necessary insulation between active parts and exposed conductive parts		
Insulation between LV supply and the secondary circuit	Output voltage	Protection class I Insulation of exposed, earthed and conductive parts	Protection class II Insulation of an exposed, conductive part or more as one with potential equalisation	Protection class II Insulation of more than one exposed, conductive part without potential equalisation
None	$U_{OUT} > LV_{Supply}$	Basic insulation suitable for U_{OUT}	Double or reinforced insulation suitable for U_{OUT}	Double or reinforced insulation suitable for U_{OUT}
	$U_{OUT} \leq LV_{Supply}$	Basic insulation suitable for U_{OUT}	Double or reinforced insulation suitable for U_{OUT}	Double or reinforced insulation suitable for LV_{Supply}
Basic	Voltage > ELV	Basic insulation suitable for U_{OUT}	Additional insulation suitable for U_{OUT} plus LV_{Supply}	Insulation must satisfy the higher requirement of a) or b) a) Additional insulation suitable for U_{OUT} plus LV_{Supply} b) Double or reinforced insulation suitable for U_{OUT}
	ELV (FELV)	Basic insulation suitable for U_{OUT}	Additional insulation suitable for U_{OUT} plus LV_{Supply}	Additional insulation suitable for U_{OUT} plus LV_{Supply}
Double or reinforced	Voltage > ELV	Basic insulation suitable for U_{OUT}	Basic insulation suitable for U_{OUT}	Double or reinforced insulation suitable for U_{OUT}
	ELV (SELV)	Basic insulation suitable for U_{OUT}	Basic insulation suitable for U_{OUT}	Basic insulation suitable for U_{OUT}
also see requirement of IEC 60598-1, sections 8, 10 and 11				

Protection classes of luminaires and operating devices

IEC 60529 (EN 60529) defines protection classes for enclosures of casings. The IP Code (International Protection Code) describes the level of protection provided against accidental contact and penetration by foreign bodies as well as protection against water. The first number stands for protection against foreign bodies, the second stands for protection against water. These specifications are important with particular regard to built-in or mounted luminaires as the provisions governing protection against accidental contact provide the basis for the insulation system for components and conductors (also see luminaire standard EN 60598-1).

To comply with the IP requirements, the installation instructions supplied by the luminaire and/or operating device manufacturer(s) must be observed.

Number	1st Number		2nd Number
	Protection against contact	Protection against foreign bodies	Protection against water
0	No protection	No protection	No protection
1	Protected against contact with the back of the hand	Protected against solid foreign bodies $\varnothing \geq 50$ mm	Protected against vertically dripping water
2	Protected against finger contact	Protected against solid foreign bodies $\varnothing \geq 12$ mm	Protected against diagonally dripping water (angle of 15° from above)
3	Protected against contact with tools	Protected against solid foreign bodies $\varnothing \geq 2.5$ mm	Protected against diagonal water spray up to an angle of 60° from above
4	Protected against contact with wire	Protected against solid foreign bodies $\varnothing \geq 1$ mm	Protected against water splashes from any direction
5	Protected against contact with wire	Protected against dust	Protected against jets of water
6	Protected against contact with wire	Dust-tight	Protected against strong jets of water
7	–	–	Protected against temporary immersion in water
8	–	–	Protected against permanent submersion in water. Specific testing conditions must be agreed, especially with regard to high-pressure cleaning equipment.
9	–	–	For high-pressure cleaning IPx9 in accordance with DIN 4005

If any components like ballasts or conductors of built-in or mounted luminaires (e.g. wall-mounted luminaires) are accessible to accidental contact, they must comply with the requirements of the two safety levels stipulated for these components. Luminaire construction must be in line with these conditions, which can mean that, for instance, conductors have to feature additional or reinforced insulation.

For lampholders the compliance with the two safety levels is proved by conducting a special voltage test.

European standard EN 50102 "Degrees of protection provided by enclosures for electrical equipment against external mechanical impacts (IK code)" introduces an IK code, analogous to the IP degree of protection of electrical control gear, that was also adopted as a national standard in France, e.g. with the French standard NF EN 50102. Testing is carried out using a pendulum hammer that, in accordance with the IK code, must be dropped from a certain height with respective weights attached to exert the specified impact energy. The table details impact energy values for luminaires (IK00 to IK10).

IK Code	Energy Nm or Joule	IK Code	Energy Nm or Joule
IK00	0.0	IK06	1
IK01	0.14	IK07	2
IK02	0.2	IK08	5
IK03	0.35	IK09	10
IK04	0.5	IK10	20
IK05	0.7		

1

2

3

4

5

6

7

8

9

10

Selection of components, materials and dimensions

The documentation provided by Vossloh-Schwabe is carefully researched. Technical advice is given to the best of our knowledge. The details on the product or the type plate are binding in every case.

Any manipulation of VS products or product packaging is illegal and violates registered trademark rights. Manipulations can negatively influence or destroy technical properties and can possibly result in secondary damage. Vossloh-Schwabe does not accept any liability for manipulated products and cannot be held responsible for any secondary damage.

Manufacturers of luminaires and lighting systems remain responsible for the selection of suitable luminaire components, e.g. operating devices and lampholders, and component materials just as for their safe and correct installation in line with luminaire and system set-up regulations.

Particular attention should be paid to the following:

- temperature measurements and temperature limits
- compliance with creepage and air clearance distances and insulation thicknesses
- selection of components to suit their operating conditions and degree of strain (e.g. voltage, current, mechanical loading, UV radiation)
- protection against contact and safe protective earth conductor connections
- resistance to corrosion

The product drawings without tolerances are contained in this catalogue only feature nominal dimensions. For space and simplicity reasons, the full dimensions and particularly the associated tolerances cannot be shown. For detailed information resp. details of luminaire design, please request our in-depth dimensional assembly drawings.

All VS products comply with the relevant standards and are developed and produced using the latest technological expertise.

To ensure safe luminaire production we do not recommend reusing dismantled lampholders.

Impulse voltage categories for lampholders

Lampholder	Standard	Impulse voltage category
E14: 250 V / 2 A	IEC 60238 / VDE 0616-1	2
E27: 250/500 V / 4 A		2
E40		2
Starters: 250 V / 2 A	IEC 60400 / VDE 0616-3	2
Fluorescent lamps 250 V / 500 V / 2 A	IEC 60400 / VDE 0616-3	2
Halogen lamps and other lamps	IEC 60838-1 / VDE 0616-5	2
Bayonet fitting	IEC 61184 / VDE 0616-2	2

Torques for screws

With regard to lampholders secured with screws, we recommend using a torque of around 80% of the value stipulated in DIN EN 60598-1

Nominal diameter of the screw's outside thread mm	Torque (Nm) for screws with a head in acc. with DIN EN 60598-1
to 2.8	0.40
< 2.8 to 3.0	0.50
< 3.0 to 3.2	0.60
< 3.2 to 3.5	0.80
< 3.6 to 4.1	1.20
< 4.1 to 4.7	1.80
< 4.7 to 5.3	2.00
< 5.3 to 6.0	2.50

A	A type, B type capacitors	The requirements of the safety standard for capacitors differentiates between capacitor types; A type capacitors stand for plastic can capacitors; B type capacitors stand for aluminium can capacitors.
	AG DALI	International working group under the umbrella of ZVEI (the German Electrical and Electronic Manufacturers' Association) in support of DALI (Digital Addressable Lighting Interface).
	Analogue interface 1–10 V	Bipolar interface of dimmable operating devices with a built-in constant current source.
	Average service life	Specified service life of electronic operating devices with a failure rate per unit of time.
B	Ballast	Device that is connected in between the voltage supply and one or more discharge lamps and serves the purpose of igniting the lamps and limiting lamp current during operation.
	Ballast-Lumen Factor (luminous flux factor of a ballast)	The ratio of luminous flux emitted by a reference lamp when operated with a particular production ballast to the luminous flux emitted by the same lamp when operated with its reference ballast.
C	Capacitive circuit (series compensation)	Circuit of an inductive ballast with a capacitor connected in series.
	CE Mark	European regulation governing all products that are introduced to the market. Products must comply with the respective EC directives.
	CELMA	Association of European component and luminaire manufacturers (Committee of E.E.C. Luminaires Components Manufacturers Associations).
	CENELEC	European committee for electronic standardisation (Comité Européen de Normalisation Electrotechnique).
	CISPR	International special commission for radio interference (Comité International Spécial des Perturbations Radioélectriques).
	Colour rendering index (CRI) R_a	Index to determine the degree of deviation from a viewed body colour (with 8 standardised test colours) under a given type of lighting. $R_a = 100$ denotes a light source that causes no distortion of any colour. Lower R_a values denote light sources with less positive colour rendition properties.
	Compensated circuit (parallel compensation)	Circuit of an inductive ballast with a capacitor between phase and neutral conductor.
	Compensation capacitors	The power factor can be increased to a value of 0.9–0.98 by using compensation capacitors.
	Conformity declaration	Documentation for an operating device or a luminaire regarding compliance with European directives; this documentation is for submission to national supervisory authorities (e.g. regulation authority for telecommunications and post (Reg. TP) or trade supervisory authorities).
	Convertors	Electronic convertor (electronic conversion of mains voltage in extra-low voltage) to generate operating voltage for low-voltage halogen lamps.
	Creepage and air clearance distances	Regulation minimum distances between voltage-carrying components of different polarity or between voltage-carrying components and the accessible casing surfaces (air clearance: shortest distance through air; creepage distance: shortest distance across a surface).
	Cross discharge	Discharge in the lamp electrode region during preheating.
D	DALI	Digital interface for controlling dimmable electronic operating devices (Digital Addressable Lighting Interface).
	Δt	Increase in the winding temperature during the operation of a ballast (the ballast is mounted on 75 mm high wooden blocks and its temperature is measured at an ambient temperature of 25 °C).
	Δt_{an}	Temperature increase during short-circuit operation (e.g. defective starter, defective lamp).
	DIAL	German institute for applied lighting technology (Deutsches Institut für Angewandte Lichttechnik), Lüdenscheid, Germany.
	DKE	German electrotechnical commission of the DIN and VDE.
	Driver	Name commonly given to ballasts used for operating LED modules.
E	EC directives	Regulations (laws) of the European Community that have to be transposed into national laws within a prescribed period of time.
	Efficiency	Ratio of power output in relation to power input.
	ELC	European Lamp Companies Federation
	EMC	Electromagnetic compatibility
	EMF	Electromagnetic fields
	ENEC agreement	Agreement between the European testing institutes for issuing the European test mark.
	ENEC mark	Marking for a device that complies with the European standards and that was tested by a testing institute that is a part of the ENEC agreement (European Norms of Electrical Certification).
	Energy classification EEI	CELMA system to determine energy classes for ballasts for fluorescent lamps (Energy Efficiency Index).
	Error current	Current that is caused by a fault in the insulation of a device or via creepage or air clearance distances.
	Error current protection switch	Evaluates the magnitude of the error current and switches the circuit off if a predefined maximum value is reached.
F	Feed-through of mains voltage	The possibility of connecting two lamps to a single terminal so that an electrical connection can be made to another device.
	FELV	Functional extra-low voltage without adequate protection from accidental contact with higher voltages in other parts of the same circuit.
	FEP capacitors	Flame- and explosion-proof capacitors with a contact breaker.
	FGL	Promotion Society for Good Lighting (Fördergemeinschaft Gutes Licht – ZVEI).
	Function protection conductor	It may be necessary to connect a "function protection conductor" to ensure compliance with the EMC requirements or as a starting aid for lamps; VS operating devices are suitably marked.

1

2

3

4

5

6

7

8

9

10

I IDC terminal (ALF terminal)	IDC-type connection terminal (Insulation Displacement Connection) for automatic luminaire fabrication (ALF terminal).
IEC	International Electrotechnical Commission
ILCOS lamp designation system	International IEC marking system for lamps.
Illuminance E_v	Illuminance (E _v) is the total luminous flux (Φ) incident on a horizontal, vertical or angled illuminated surface (per unit area). The unit is lux [lx=lm/m ²], with luminous flux in [lm] and area in [m ²]. Illuminance E _v forms the basis for all lighting calculations and designs.
Impedance	Impedance is a conductor's apparent resistance to an alternating current.
IMQ	Italian institute for quality marking; at the same time, the mark of conformity with standards (Istituto Italiano del Marchio di Qualità).
Independent lamp operation	Possibility of operating a single lamp with a multi-lamp operating device after the other lamps have failed.
Independent operating device	Operating device that does not have to be installed in a casing; the safety regulations are fulfilled by the operating device itself.
Inductance	Inductance establishes the connection between the current and the magnetic flux caused by it in a conductor arrangement after taking account of all design and material fluctuations.
Inductive circuit	Operation of a fluorescent lamp with a ballast without a capacitor.
Interference	Interference signals emitted by operating devices via the mains voltage or the air.
Interference immunity	Property of an operating device to remain fully functional despite interference emitted by other operating devices.
IP numbers	Code system for marking the protection level of an operating device or a luminaire against moisture or foreign bodies entering (the first figure stands for foreign bodies and the second for moisture).
IPP technology	Generating the ignition voltage required for high-pressure lamps using the special intelligent pulse pause technology.
L LBS lamp designation System	Marking system for lamps, established for Europe.
Leak current	Current of an operating device or a luminaire that is discharged via the potential compensation conductor (earth conductor).
LED (light emitting diode)	Solid state device embodying a p-n junction, emitting optical radiation when excited by an electric current.
LED light engine	Functional unit consisting of an LED module and control gear. The LED light module and the control gear can be used separately in two different casings or combined as a single unit.
LED module	Unit supplied as a light source. In addition to one or more LEDs it may contain other components, e.g. optical, electrical, mechanical and/or electronic.
Light colour	Perceived colour of the light radiated by a lamp.
LightingEurope	An industry association consisting of European lamp, component and luminaire manufacturers as well as national lighting associations in Europe. LightingEurope is the successor organisation of CEI/MA and ELC (European Lamp Companies). LightingEurope represents the interests of the European lighting industry.
Light intensity distribution curve	Represents the spatial distribution of the light intensity of light sources.
LiTG	German Association for Lighting Technology (Deutsche Lichttechnische Gesellschaft)
Luminance L	Luminance L is the luminous intensity density of an area that emits or reflects light with a certain emission angle. The unit of luminance L is [cd/m ²] and is the photo-technical measure that corresponds to the subjective perception of the level of brightness of a light source or an object, while luminous flux Φ, luminous intensity I and illuminance E are not visible, i.e. not sensed by the human eye. Light only becomes visible when it hits an object that it is either reflected by or penetrates in a diffused manner. Objects of different levels of brightness therefore only seem to be darker or brighter at same illuminance because they reflect the light differently.
Luminous efficiency / efficiency	Ratio of luminous flux to power input (lm/W).
Luminous flux Φ (photon radiation)	Luminous flux Φ is the radiated/emitted light power in lumen [lm] of a light source, a unit of measurement for the number of light photons emitted in all directions. Luminous flux is the photometrical light output perceived by the human eye.
Luminous intensity I	Luminous intensity I in [cd] is decisive for characterising of a source of light and is defined as a quotient of the emitted luminous flux Φ and the radiated area of the solid angle Ω. Luminous intensity I is thus the focused luminous flux Φ within the radiated solid angle Ω. Today's LEDs can reach a luminous intensity of more than I=10 cd. The luminous intensity value depends on the viewing angle, i.e. the luminous intensity of an LED chip in a 30° reflector will be higher than that of an identical LED chip in a 60° reflector. This is because a 60° reflector results in the same luminous flux Φ having to illuminate a larger area.
M Mains harmonics	Mains current distortions by higher-frequency currents.
Master/slave circuit	Operating several lamps in different luminaires with one ballast.
µF	Unit of capacitance (microfarad)
MPP capacitors	Metallised polypropylene film dielectric capacitors.
P Parallel-compensated circuits	Circuit of an inductive ballast with a capacitor between phase and neutral conductor (connected in parallel to the lamp circuit).
Part load range	Variable load range up to the maximum rated load.
PELV	Protective extra-low voltage with adequate protection from accidental contact with higher voltages in other parts of the same circuit.
Phase-cutting leading-edge control	In accordance with the defined angle, voltage regions are suppressed of the positive and negative sinusoidal oscillations of the mains voltage in an upwards direction starting with the voltage zero crossing.
Pinch temperature	This is measured at a defined point of the lamp base; the permissible maximum values are internationally determined.
Polyester resin impregnation	High-grade vacuum impregnation with polyester resin.
Power factor	Ratio of true power to apparent power (total power). Lambda (λ) expresses the power factor for non-sinusoidal currents and voltages. In contrast, cos φ (phi) expresses the power factor for sinusoidal currents or voltages.
Pulse Ignition	Generation of the ignition voltage for high-pressure lamps with the help of ballasts (ballast insulation must match the ignition voltage).
PUSH	Key-operated bipolar interface of VS electronic ballasts for controlling the brightness of connected lamps.

R Reference ballast	Special ballast that is either inductive for lamps operated with mains voltage or ohmic for lamps operated at high frequencies. Reference ballasts are designed to deliver comparable values for testing ballasts, selecting reference lamps and testing mass-produced lamps under standardised conditions.
Reference lamp	When used in combination with a suitable reference ballast, reference lamps provide key electrical data that are close to the target values laid down in the lamp standards.
S Safety transformer	Isolation transformer for supplying circuits with safety extra-low voltages.
SELV	Safety extra-low voltage.
Short-circuit-proof	Short-circuit-proof operating devices do not pose a safety risk if a short-circuit occurs at the output of the operating device; a difference is made between operating devices offering limited and unlimited protection against short-circuit; in the case of operating devices with limited short-circuit protection, an additional mechanism has to be installed.
Solid angle Ω	Solid angle Ω is the area within a sphere that is pervaded by the light emitted by a light source. The steradian (sr) is the unit of measure for solid angle, whereby $1 \text{ sr} = 65.5^\circ$. This describes a cone with its peak in the light source and a beam spread angle of 65.5° . A whole solid angle is expressed as $4\pi \text{ sr} = 12.56 \text{ sr}$.
Standards	VS products comply with the regulations of the following European standards: <ul style="list-style-type: none"> • Electronic ballasts for fluorescent lamps: EN 61347-1, EN 61347-2-3, EN 60929, EN 55015, EN 61547, EN 61000-3-2, IEC 62493 • Electronic ballasts for high-pressure discharge lamps: EN 61347-1, EN 61347-2-12, EN 55015, EN 61547, EN 61000-3-2, IEC 62493 • Electronic converters: EN 61347-1, EN 61347-2-2, EN 61047, EN 55015, EN 61547, EN 61000-3-2, IEC 62493 • Electromagnetic ballasts: EN 61347-1, EN 61347-2-8, EN 61347-2-9, EN 60921, EN 60923, EN 50294, EN 55015, EN 61547, EN 61000-3-2, IEC 62493 • Electromagnetic transformers: EN 61558-1, EN 61558-2-6, EN 55015, EN 61547, EN 61000-3-2, IEC 62493 • Ignitors: EN 61347-1, EN 61347-2, EN 60927, EN 55015, EN 61547, EN 61000-3-2 • Capacitors: EN 61048, EN 61049 • Lampholders: EN 60238, EN 60400, EN 60838-1, EN 61184, EN 60399 • Digital control inputs of operating devices: IEC 62386 • LED: IEC 62031, IEC 61347-1, IEC 61347-2-13, IEC 62384, IEC 61231, IEC TR 61341, IEC 60838-2-2, IEC 62471(-1), IEC 62471-2 • EMC/EMF: EN 55015, EN 61547, EN 61000-3-2, IEC 62493
Stroboscopic effect	Optical illusion whereby objects appear either to be moving or stationary in contrast to their actual state when illuminated by periodically alternating light.
Superimposed ignition	Generation of the ignition voltage required for high-pressure lamps by the ignitor independent of the ballast (superimposed over the mains voltage).
System power consumption	Total power input of lamp and operating device (in watt).
T t_a	Ambient temperature
TALQ	Industrial consortium for the globally recognised standardisation of a management software interface for outdoor lighting networks. The aim is to enable the interoperability of central management systems and outdoor lighting networks made by different manufacturers.
Tandem circuit	Series connection of two fluorescent lamps using a single ballast.
t_c	Maximum operating temperature of the casing at the marked measuring point.
Temperature details	The temperature details on our VS ballasts are always maximum values; these are based on the maximum voltage values given on the type plate.
The Connected Lighting Alliance	Industrial consortium that was founded by GE Lighting, Lutron, OSRAM, Panasonic, Philips, Toshiba in August 2012 for the purpose of supporting global use and distribution of wireless connectivity in lighting applications.
Thermal classes	Classification of transformers according to the degree of heat resistance offered by the insulation materials.
Thermal cut-out	Protection from overheating due to abnormal lamp conditions (rectifier effect, short-circuit and overload), with automatic restart after cooling.
Transient mains overvoltages	Voltage peaks that briefly occur and are superimposed over the mains voltage.
T rating	Rated value of the lampholder's maximum operating temperature (e.g. T130).
Tungsten-halogen cycle	In the outer, cooler part of the lamp, the halogen combines with the tungsten vapour released by the filament to form a tungsten-halogen molecule which then decomposes and deposits the tungsten on the filament.
t_w	Maximum permissible winding temperature.
U UL, UL approval	Underwriters' Laboratories Inc., USA; US conformity mark for safety.
V VDE mark	Safety mark on the basis of the German safety standard for electrical equipment; tested by the VDE-PZI (Verband Deutscher Elektrotechniker – Prüf- und Zertifizierungsinstitut).
W Winding temperature	Temperature of the copper winding in a magnetic ballast; the change in winding temperature is measured using the change of the resistance of the copper winding.
Z Zhaga	Global industrial consortium that has taken on the task of standardising the interfaces needed for LED light engines.
ZVEI	Central association of the electrotechnical and electronics industry in Germany (Zentralverband Elektrotechnik- und Elektronikindustrie e.V.).

1

2

3

4

5

6

7

8





















9

10

Reference Numbers

Ref. No.	Type	Page	Approval
100064	02120	200	1,3
100069	02150	200	1,3,33
100082	02525	76	1
100086	02543	76	1
100096	02574	75	1
100098	02575	76	1
100125	03210	307	—
100194	06700	307	—
100217	07400	308	—
100270	08610	307	—
100273	08701	307	—
100305	09105	174	1,3
100310	09205	174	1,3
100437	20200	207	1
100442	20400	192	—
100448	20501	192	—
100484	22600	186	1,3,33
100486	22601	186	1,3,33
100487	22602	186	1,3,33
100551	27356	191	1,3
100557	27450	184	1,3,33
100559	27460	184	1,3
100572	27722	191	1,3
100579	27820	182	1,3,33
100581	27821	182	1,3
100583	27822	191	1,3
100585	28100	184	1,3,33
100588	28200	184	1,3,33
100591	28500	183	1,3,33
100593	28501	183	1,3,33
100616	30023	275	1
100662	30300	267	1
100710	30523	275	1
100720	30550	275	1
100723	30602	75	1
100741	30620	75	1
100912	32300	273	1
100913	32301	73	1
100921	32311	73	1
100922	32321	73	1
100925	32326	74	1
100928	32330	74	1
100931	32336	74	1
100932	32341	73	1
100934	32361	73	1
100937	32381	74	1
100939	32400	261, 264, 266	1
101162	32600	265	1
101207	32620	265	1
101248	32680	265	—
101253	32690	265	—
101258	32700	261	1
101274	32720	261	1
101298	35004	164	1,3,33
101306	35006	164	1,3,33
101310	35007	164	1,3,33
101314	35008	164	1,3
101320	35010	165	1,3,33





















Ref. No.	Type	Page	Approval
101324	35011	165	1,3,33
101344	35051	165	1,3,33
101346	35052	165	1,3
101364	35201	166	1,3,33
101485	36050	168	1,3,33
101489	36051	168, 343	1,3,33
101491	36052	168	1,3,33
101493	36053	168	1,3,33
101497	36061	171	—
101521	36300	167	1,3
101627	43000	201	1,3,33
101629	43010	201	1,3
101631	43100	201	1,3
101636	43300	202	1,3,33
101643	46100	190	1,3
101647	46101	190	1,3
101681	47102	188	1,3
101706	47200	188	1,3
101712	47205	189	1,3
101716	47206	189	1,3
101740	47502	188	1,3
101745	47504	189	1,3,33
101765	47600	188	1,3
101769	47605	189	1,3,33
101773	47606	189	1,3
101781	47700	189	1,3
101784	47900	189	1,3,33
101785	47920	190	1,3,33
101787	48500	190	1,3
101789	48501	190	1,3
101791	48502	192	1,3
101793	48503	192	1,3
102577	62010	65, 298	1
102582	62015	65, 298	1
102599	62050	65, 298	1
102615	62104	65	1
102617	62105	65	1
102624	62310	66, 299	1
102635	62600	64	1
102637	62601	64	1
102923	78100	268	1,3
102938	80003	288	—
102939	80003	288	—
102946	80006	288	—
102947	80006	288	—
102956	80014	303	—
103020	80342	300	—
103021	80342	300	—
103026	80343	300	—
103027	80343	300	—
103087	80433	308	—
103359	81019	287	—
103360	81019	287	—
103365	81022	288	—
103366	81022	288	—
103414	81093	285	—
103415	81093	285	—
103424	81095	285	1,33

- 1  ENEC
1a applied
- 2 
- 3  UL US
- 5 
- 7 
- 13 
- 13a 
- 14  VDE
14a applied
- 15 
- 16 
- 17 
- 19 
- 25 
- 28 
- 31 
- 32 
- 33 
- 34  UL US
- 35 
- 36  DEKRA

Reference Numbers

Ref. No.	Type	Page	Approval
103430	81109	285	—
103431	81109	285	—
103442	81120	285	—
103443	81120	285	—
103467	83000	295	—
103468	83000	295	—
103483	83002	295	—
103484	83002	295	—
103504	83006	302	1
103515	83008	302	1
103520	83011	295	1,33
103569	83173	295	—
103570	83173	295	—
103582	83218	300	—
103583	83218	300	—
103587	83218	303	—
103590	83219	300	—
103591	83219	300	—
103594	83219	303	—
103595	83221	300	1
103597	83223	300	1
103643	83285	295	1,33
103709	84122	197	—
103710	84122	197	—
103711	84123	197	—
103712	84123	197	—
103743	84154	197	—
103744	84154	197	—
103818	86037	76	—
104928	94304	301,302	—
105144	96010	301,302	—
105179	96033	301	—
105185	96034	301	—
105448	97031	169	—
105482	97064	203	—
105483	97065	203	—
105775	35060	170	—
105776	35060	169	—
105777	35760	169	—
105843	97532	192	—
105931	35061	169	—
105981	97638	170	—
106094	98085	196	—
106095	98086	203	—
106256	94060	267	—
106416	35060	169	—
106417	35760	169	—
106455	9210	174	1,3
106457	32480	265	1
106585	62110	65	1
106766	94067	308	—
106767	94068	308	—
106768	94069	308	—
106802	94074	308	—
106817	98006	305	—
106818	02170	201	1,3
106829	94450	309	—
106948	09501	311	—

Ref. No.	Type	Page	Approval
106949	09502	311	—
107065	31662	72	1
107066	31672	72	1
107096	83015	303	1
107154	05202	307	—
107177	96242	293	—
107178	96206	293	—
107192	32360	274	1
107193	32340	274	1
107194	32320	274	1
107195	32310	274	1
107213	32390	273	1
107214	32391	273	1
107215	32395	273	1
107331	83015	303	1
107445	43410	203	1
107677	21100	77	34
107694	33100	267	—
107716	81096	285	1,33
107780	12801	67,313	1
107957	84171	194	1
107958	84172	195	1,3
107959	84173	194	1
107960	84174	195	1,3
108208	12800	67,313	1
108266	98003	180,193,194	—
108267	98004	179,195	—
108304	97159	310	—
108373	12812	68,313	1
108374	12810	68,313	1
108375	12811	68,313	1
108416	62622	65	1
108437	28920	185	1,3
108438	28921	185	1,3
108449	30471	263	1
108454	43500	202	1
108608	84175	195	1,3
108614	84175	195	1,3
108666	84172	195	1,3
108669	84174	195	1,3
108671	43020	201	1,3
108678	94071	264	—
108718	62150	64	1
108719	62151	64	1
108747	64740	290	1,3,33
108748	64800	305	1
108758	64741	291	1,3,33
108773	22800	186	1
108775	22801	186	1
108777	22850	186	1
108778	22851	186	1
108780	97044	192	—
108816	22604	186	1,3,33
108845	97117	193	—
108878	36060	170	—
108898	35012	165	1,3,33
108927	35500	166	1,3
108928	35510	166	1,3





















1	
	ENEC 1a applied
2	
3	
5	
7	
13	
13a	
14	
	VDE 14a applied
15	
16	
17	
19	
25	
28	
31	
32	
33	
34	
35	
36	

1
2
3
4
5
6
7
8
9
10

Reference Numbers

Ref. No.	Type	Page	Approval
108932	35530	166	1,3
108933	35540	167	1,3
108934	35550	167	1,3
108936	64401	289	1,33
108937	02500	75	1
108940	85007	276	—
108947	98002	179	—
108953	64770	290	1,33
108956	97194	309	—
108965	64501	289	1,33
108979	31000	271	1,34
108983	64307	281	1,33
108984	22900	186	1
109007	31010	271	1,34
109014	12870	342	34
109039	83007	296	—
109041	81130	286	—
109044	96172	297	—
109045	97511	293	—
109052	83007	296	—
109054	81130	286	—
109060	96172	297	—
109062	97511	293	—
109074	83293	296	—
109077	85070	291	—
109081	83274	297	—
109084	96159	286	—
109086	97147	193	—
109087	83293	296	—
109092	85070	291	—
109093	83274	297	—
109095	96159	286	—
109098	83035	296	—
109099	83035	296	—
109102	81002	286	—
109103	81002	286	—
109110	85075	282	—
109112	85075	282	—
109119	97666	283	—
109120	97666	283	—
109122	97635	283	—
109123	97635	283	—
109126	97697	283	—
109145	81024	286	—
109149	96211	286	—
109150	96211	286	—
109152	81132	287	—
109153	81132	287	—
109158	83297	304	1
109159	83282	293	—
109162	03210	307	—
109166	05202	307	—
109184	97698	292	—
109187	96148	296	—
109188	96148	296	—
109190	96154	297	—
109191	96154	297	—
109195	96147	296	—





















Ref. No.	Type	Page	Approval
109196	96147	296	—
109198	83260	303	—
109199	83260	303	—
109200	96229	304	—
109201	96229	304	—
109235	35610	163	1,3
109238	35611	163	1,3
109240	35612	163	1,3
109243	83300	304	—
109247	09708	310	—
109248	09701	311	—
109249	09703	310	—
109253	09701	311	—
109280	96033	301	—
109281	96034	301	—
109282	83258	302	—
109283	83258	302	—
109285	08610	307	—
109291	08701	307	—
109317	96160	311,312	17
109318	96160	311,312	17
109330	27700	181	1,3,33
109331	27701	181	1,3,33
109332	27800	181	1,3
109335	27801	181	1,3
109338	28500	182	1,3,33
109339	28501	182	1,3,33
109340	28600	182	1,3,33
109341	28601	182	1,3,33
109342	28700	345	—
109343	28701	345	—
109376	28725	345	—
109377	28726	345	—
109383	64001	280	1,33
109384	64001	280	1,33
109386	64101	280	1,33
109387	64101	280	1,33
109411	97244	271	—
109429	64501	289	1,33
109462	83282	293	—
109497	32380	274	1
109512	96124	297	—
109518	12876	342	34
109532	84000	180	—
109547	33300	260,264,266	1,34
109548	97255	260	—
109550	97257	260,269	—
109553	94095	264	—
109554	94096	266	—
109555	97260	293	—
109556	97260	293	—
109559	96124	297	—
109560	97698	292	—
109568	62111	65	1
109575	97065	203	—
109592	09705	311	—
109600	09704	312	—
109621	94435	308	—

- 1  ENEC
1a applied
- 2 
- 3  UL US
- 5 
- 7 
- 13 
- 13a 
- 14  VDE
14a applied
- 15 
- 16  TUV
Type Approved
Energy
Efficient
Products
Certification
Institution
- 17 
- 19 
- 25 
- 28  VDE
EMC
- 31  RAM 
- 32 
- 33 
- 34  RU US
- 35  ETL
RECOGNIZED
COMPONENT
US
- 36  DEKRA

Reference Numbers

Ref. No.	Type	Page	Approval
109622	94436	308	—
109674	33400	260	1,34
109676	97636	282	—
109677	97636	282	—
109679	97665	292	—
109680	97665	292	—
109685	94088	178	—
109686	09170	177	1,3
109725	97750	309	—
109728	97752	309	—
109784	02110	200	1,3,33
109790	43200	202	1,3
109792	43210	202	1,3,33
109794	97664	292	—
109795	97664	292	—
109805	81024	286	—
109838	64770	290	1,33
140413	Z 70 S	42	1,14
140425	Z 250 S	43	1,14
140427	Z 400 S	44	1,14
140430	Z 1000 S	47	1,14
140432	Z 2000 S	50	—
140471	Z 1000 L	48	—
140481	Z 70 K	42	1,14
140489	Z 250 K	43	1,14
140496	Z 1000 S/400 V	48	14
140497	Z 2000 S/400 V	50	14
140499	Z 3500 S/400 V	50	—
140537	CE 50	60	—
140594	Z 400 M	45	1,14
140597	Z 400 M K	45	1,14
140607	Z 1000 TOP	47	14
140608	Z 1200/2,5	49	—
140609	Z 1200/9	49	—
140613	PZS 1000 K	52	14
140617	PZI 1000/1 K	52	14
140621	PU 12 K	55	14
140622	PU 120 K	55	14
140623	PU 121 K	55	—
140627	AS 1000 K	58	1,14
140693	Z 400 M S	45	1,14
141193	AS 1000 K A10	59	—
141580	Z 70 K D20	42	1,14
141581	Z 250 K D20	43	1,14
141582	Z 400 M K D20	45	1,14
141583	Z 400 S D20	44	1,14
141584	Z 1000 S D20	47	1,14
142098	ZPU 70 K D20	56	14
142099	ZPU 250 K D20	56	14
142150	PR 12 K D	55	14
142170	PR 12 K LC	55	14
142330	Z 70 K D20	42	1,14
142350	Z 250 K D20	43	1,14
142370	Z 400 M K D20	45	1,14
142783	PZ 1000/400 V A5	51	14
142784	PZ 1000 K D20	51	14
142897	Z 400 M K VS-Power	45	14
146990	Z 750 S	46	14

Ref. No.	Type	Page	Approval
147230	SP 230/10 K	12	14
147707	Z 400 M VS-Power	45	14
147790	HZ 600 K	53	—
147791	HZ 1000 K	54	—
147793	HZ 2000 K/400 V	54	—
149992	SU 1-10 V K	57	14
149993	PR 1-10 V K LC	57	14
159968	O607	193	—
160597	NaHJ 250.160	21	1,19,31
160604	NaHJ 250.163	21	—
160613	NaHJ 70/50.157	20	1
161158	NaHJ 100/70.519	21	1
161367	NaHJ 35.485	20	1
161371	NaHJ 35.638	20	—
161379	NaH 50.486	20	1
161392	NaHJ 70.653	20	—
161399	NaH 50.654	20	—
161460	UNaH 70/40%.691	36	—
161469	NaHJ 100/70.703	21	1
161471	NaHJ 100/70.709	21, 36	—
161475	UNaH 150/40%.717	36	—
161662	NaHJ 70.158	20	1
161686	NaHJ 250.915	21	1,31,32
161707	NaHJ 100.941	21	1
161757	STr 50/12.301	255	15,19
161781	STr 20/12.306	255	19
161860	STr 20/12.306	256	19
161935	STr 105/12.406	256	—
163305	L7/9/11.207	149	—
163683	L4/6/8.304	153	1,19,25
163694	L7/9/11.307	148	1,19,25,31
163711	LN 13.313	148,153	1,19,25,31
163730	LN 16.316	148,154	1,25
163763	LN 181.319	149	1,19,25,31
163861	LN 15.329	154	1,25
164013	L 25.346	154	1
164033	L 30.347	154	19,25,31
164326	L4/6/8.404	153	1
164335	L7/9/11.411	148	1
164342	LN 13.413	148,153	1
164353	LN 181.418	150	1
164358	LN 16.417	148,155	1
164438	L 36/40.443	150,155	1
164555	LN 36.505	150,155	1
164560	LN 58.506	150,155	1
164566	LN 18.507	150,155	1
164572	LN 18.510	149,150,154	1
164590	LN 36.511	150,154	1
164680	LN 30.530	149	—
164779	L 181.602	151	—
164828	L 58.625	151,155	—
164870	L 58.657	151,155	—
167100	Q 50.501	31	1
167125	Q 50.508	31	1
167132	Q 80.510	31	1
167136	Q 125/80.511	31	1
167140	Q 125.512	31	1
167144	Q 250.513	31	1,19,31





















1	
	ENEC
1a	applied
2	
3	
5	
7	
13	
13a	
14	
	VDE
14a	applied
15	
16	
17	
19	
25	
28	
31	
32	
33	
34	
35	
36	

1
2
3
4
5
6
7
8
9
10

Reference Numbers

Ref. No.	Type	Page	Approval
167185	Q 50.535	31	—
167213	Q 50.550	31	1,32
167250	Q 400.561	31	1,19,31
167263	Q 125.568	31	1,19,31,32
167299	Q 80.584	31	—
167302	Q 80.587	31	19
167304	Q 80.588	31	1,19,31,32
167306	Q 80/50.592	31	—
167311	Q 80/50.596	31	1
167326	Q 125/80.611	31	1
167330	Q 400.612	31	1,19,31,32
167335	Q 400.613	31	—
167367	Q 250.528	31	1,19,31,32
167374	Q 400.669	31	1
169125	STr 105/12.406	255	—
169389	LN 58.568	150,154	1
169645	LN 30.801	154	1
169647	LN 13.805	148	1
169721	NaHJ 150.995	23	1,32
169722	NaHJ 70.158	23	1,32
169747	STr 105/12.311	256	19,31
169748	STr 50/12.401	256	—
169779	LN 36.570	150,154	1
169830	STr 50/12.401	255	—
169892	UNaH 250/40%.983	36	—
169947	Q 125.549	31	1,19
170002	STr 105/12.311	255	15,19,31
170091	STr 50/12.301	256	14,19
172775	Cover plate	144	—
172776	Light sensor	144	—
172777	Multi sensor	144	—
172778	Manual controller	144	—
174961	NaHJ 70.300	20	1,31
178177	NaHJ 250.340	21	1
178771	NaHJ 250.727	28	1,19,32
178790	NaHJ 400.006	28	1,31,32
179424	NaHJ 400.737	28	1,19,31,32
179444	STr 50/12.337	256	—
179454	NaH 600.005	28	1,19
179604	STr 60/12.338	255	—
179608	STr 60/12.338	256	—
179740	NaHJ 400.006	28	1,31,19
179742	NaH 600.010	28	1
179743	NaHJ 250.003	28	1
183033	EHXc 35.325	9	1,14,28
183034	EHXc 35.325	9	1,14,28
183035	EHXc 35.325	9	1,14,28
183036	EHXc 70.326	9	1,14,28
183038	EHXc 70.326	9	1,14,28
183039	ELXc 424.223	137	1,14,28
183040	ELXc 226.878	129	1,14,28
183046	EHXc 150G.334	10	1,14,28
183047	EHXc 150G.334	10	1,14,28
183059	ELXd 235.735	142	1,14,28
183108	ELXc 226.878	129	1,14,28
183109	ELXc 414.227	139	16
183110	ELXc 424.228	139	16
183111	ELXc 228.229	139	16





















Ref. No.	Type	Page	Approval
183112	ELXc 328.230	139	16
183113	ELXc 135.231	139	16
183114	ELXc 235.232	139	16
183115	ELXc 239.233	139	16
183116	ELXc 149.234	139	16
183117	ELXc 249.235	139	16
183118	ELXc 254.236	139	16
183119	ELXc 180.237	139	16
183122	ELXc 114.238	140	16
183123	ELXc 128.239	140	16
183124	ELXc 214.240	140	16
183125	ELXc 228.241	140	16
183126	ELXc 414.242	140	16
183127	ELXc 118.243	140	16
183128	ELXc 136.244	140	16
183129	ELXc 158.245	140	16
183130	ELXc 218.246	140	16
183131	ELXc 236.247	140	16
183132	ELXc 258.248	140	16
183133	ELXc 418.249	140	16
183134	ELXc 118.879	131	16
183135	ELXc 126.880	131	16
183136	ELXc 218.881	131	16
183137	ELXc 226.882	131	16
186072	EST 70/12.380	254	1,14,28
186077	EST 105/12.381	254	1,14,28
186098	EST 150/12.622	254	1,14,28
186173	EST 60/12.635	254	13
188080	Cord Grip	11	—
188093	ELXc 135.856	137	1,14,28
188094	ELXc 235.857	137	1,14,28
188095	ELXc 149.858	137	1,14,28
188140	ELXc 140.862	122,137	1,14,28
188142	ELXc 154.864	137	1,14,28
188144	ELXc 180.866	122,137	1,14,28
188329	ELXd 124.600	124,143	1,14,28
188330	ELXd 224.601	124,143	1,14,28
188331	ELXd 139.602	124,143	1,14,28
188332	ELXd 154.603	124,143	1,14,28
188333	ELXd 254.604	124,143	1,14,28
188334	ELXd 180.605	124,143	1,14,28
188335	ELXd 249.606	143	1,14,28
188336	ELXd 124.607	124,142	1,14,28
188337	ELXd 224.608	124,142	1,14,28
188338	ELXd 139.609	124,142	1,14,28
188339	ELXd 239.610	124,142	1,14,28
188340	ELXd 154.611	124,142	1,14,28
188341	ELXd 254.612	124,142	1,14,28
188342	ELXd 180.613	124,142	1,14,28
188343	ELXd 249.614	142	1,14,28
188350	ELXd 239.621	124,143	1,14,28
188431	ELXd 226.801	134	14,28
188438	ELXc 414.868	137	1,14,28
188490	ELXd 226.801	134	14,28
188549	ELXd 218.803	134	1,14,28
188550	ELXd 242.807	134	1,14,28
188564	ELXd 118.802	134	1,14,28
188565	ELXd 142.806	134	1,14,28

- 1  ENEC
1a applied
- 2 
- 3 
- 5 
- 7 
- 13 
- 13a 
- 14  VDE
14a applied
- 15 
- 16  TUV Approved
16
- 17 
- 19 
- 25 
- 28  VDE
EMC
- 31  RAM
- 32 
- 33 
- 34  UL US
- 35  ETL RECOGNIZED
COMPONENT
- 36  DEKRA

Reference Numbers

Ref. No.	Type	Page	Approval
188589	ELXc 128.869	127	1,14,28
188590	ELXc 128.869	129,13	1,14,28
188595	ELXc 336.214	137	1,14,28
188597	ELXd 324.623	124,142	1,14,28
188598	ELXd 424.624	124,142	1,14,28
188600	ELXd 324.626	124,143	1,14,28
188602	ELXd 424.628	124,143	1,14,28
188604	ELXd 280.630	142	1,14,28
188605	ELXd 280.631	143	1,14,28
188616	ELXc 240.863	122,137	1,14,28
188617	ELXc 249.859	137	1,14,28
188618	ELXc 254.865	122,137	1,14,28
188619	ELXc 280.538	122,137	1,14,28
188643	ELXc 242.837	127,128	1,14,28
188680	ELXc 155.378	128	1,14,28
188681	ELXc 155.378	130	1,14,28
188694	ELXd 118.802	134	1,14,28
188695	ELXd 142.806	134	1,14,28
188696	ELXd 218.803	134	1,14,28
188697	ELXd 242.807	134	1,14,28
188698	ELXc 213.870	127	1,14,28
188699	ELXc 218.871	127	1,14,28
188700	ELXc 142.872	127,128	1,14,28
188704	ELXc 136.207	138	14
188705	ELXc 236.208	138	14
188706	ELXc 158.209	138	14
188707	ELXc 258.210	138	14
188712	ELXc 213.870	129	
188713	ELXc 218.871	129	1,14,28
188714	ELXc 142.872	129,13	1,14,28
188717	ELXd 135.823	142	1,14,28
188744	ELXc 418.204	137	1,14,28
188792	EMXs 180.000	331	36
188793	EMXs 180.001	331	36
188794	EMXs 180.002	331	36
188795	EMXs 180.003	331	36
188823	EMXs 180.000	331	—
188824	EMXs 180.001	331	—
188825	EMXs 180.002	331	—
188826	EMXs 180.003	331	—
188827	Battery Holder	331	—
188828	Battery Holder	331	—
188829	Battery Holder	331	—
188873	ELXd 118.718	124,142	1,14,28
188874	ELXd 218.719	124,142	1,14,28
188875	ELXd 136.720	124,142	1,14,28
188876	ELXd 236.721	124,142	1,14,28
188877	ELXd 158.722	124,142	1,14,28
188878	ELXd 258.723	142	1,14,28
188912	ELXc 136.216	138	1,14,28
188913	ELXc 236.217	138	1,14,28
188914	ELXc 158.218	138	1,14,28
188915	ELXc 258.219	138	1,14,28
188921	ELXc 135.220	138	14,28
188922	ELXc 235.221	138	14,28
188923	ELXd 142.709	135	1,14,28
188924	ELXd 142.709	135	1,14
188932	ELXd 135.724	143	1,14,28

Ref. No.	Type	Page	Approval
188933	ELXd 235.725	143	1,14,28
188953	ELXd 118.705	135	1,14
188954	ELXd 218.707	135	1,14,28
188955	ELXd 218.707	135	1,14
188974	ELXd 242.711	135	1,14,28
188975	ELXd 242.711	135	1,14
188993	EHXc 35G.327 B	8	1,14,28
188994	EHXc 35G.327 I	8	1,14,28
400671	94066	308	—
400699	80474	308	—
400732	97755	310	—
400772	80476	309	—
400779	80475	309	—
400817	85076	282	—
400818	85076	282	—
400819	85077	292	—
400820	85077	292	—
400913	12600	67	1
400914	12600	67	1
400915	12610	67	1
400916	12610	67	1
400917	12614	67	1
400918	12614	67	1
401536	94444	309	—
401549	94438	309	—
401970	97754	310	—
500296	Capacitor	240	1
500299	Capacitor	240	1
500300	Capacitor	240	1
500301	Capacitor	240	1
500302	Capacitor	240	1
500303	Capacitor	240	1
500304	Capacitor	240	1
500305	Capacitor	240	1
500315	Capacitor	240	1
500316	Capacitor	240	1
500317	Capacitor	240	1
500318	Capacitor	240	1
500319	Capacitor	240	1
500320	Capacitor	240	1
500321	Capacitor	240	1
500322	Capacitor	240	1
500323	Capacitor	240	—
500401	NaHJ 250.011	28	—
500402	NaHJ 400.737	28	1
500403	NaHJ 400.012	28	1
500574	35613	163	1,3
500757	84001	178,18	—
500810	64401	289	1,33
500843	STr 50/12.207	255	—
500969	NaHJ 250.727	28	1,19
500976	NaHJ 250.727	28	1,19
501351	08400	302	—
501352	08400	302	—
501356	64601	289	1,33
501358	64601	289	1,33
501942	97268	270	—
502004	33500	270	1,34





















1	
	ENEC 1a applied
2	
3	
5	
7	
13	
13a	
14	
	VDE 14a applied
15	
16	
17	
19	
25	
28	
31	
32	
33	
34	
35	
36	

1
2
3
4
5
6
7
8
9
10

Reference Numbers

Ref. No.	Type	Page	Approval
502064	97320	271	—
502111	31020	271	1,34
502112	31030	271	1,34
502394	33600	69	1
502416	97282	272	—
502503	05202	270	—
502515	83301	305	—
502592	STr 50/12.422	255	—
502783	Capacitor	240	1
502799	NaHj 100.941	23	1
502818	Q 125.598	31	—
503010	NaHj 35.485	23	1,32
503041	64781	290	1,33
503136	NaHj 70/50.695	37	1
503457	97000	284	5
503458	97000	284	5
503579	97322	282	—
503773	98087	179,196	—
503923	64201	280	1,33
503924	64201	280	1,33
504078	98011	179,195	—
504109	NaHj 250.340	21	1
504131	NaHj 100/70.703	23, 37	1
504135	NaHj 150/100.973	23, 37	1
504202	28315	184	1
504302	64719	289	1,33
504303	64719	289	1,33
504351	Capacitor	240	1
504416	31695	72	1
504467	Q 250.417	33	1,32
504474	Q 400.001	33	1,32
504615	97321	291	—
504640	83226	300	—
504641	83226	300	—
504643	83227	300	—
504644	83227	300	—
504669	31696	72	1
504749	96021	305	—
504769	83283	293	—
504938	97277	171	—
504939	97278	171	—
505002	Q 400.001	33	1
505014	64770	64	1
505054	NaHj 250.915	23	1,31,32
505251	93088	277	15
505389	64770	64	1,33
505720	64719	64	1
505721	64719	64	1,33
505732	09404	175,178	1,3
505733	09405	175	1,3,33
505734	09406	175	1,3,33
505735	09415	175	1,3,33
505736	09416	175	1,3,33
505737	09420	176,346	1,3,33
505739	09421	176,346	1,3
505745	09426	176	1,3,33
505746	09427	176	1,3,33
505747	09440	176	1,3





















Ref. No.	Type	Page	Approval
505750	09450	177	1,3,33
505751	09460	177	1,3,33
505782	J 400.027	28	1
505951	83310	270	—
506007	28310	184	1,33
506020	09607	312	17
506024	09607	312	17
506026	09606	311	17
506027	09606	311	17
506120	NaHj 100.670	22	1,19
506122	NaHj 35.485	22	1,32
506211	94079	308	—
506247	64360	281	1,33
506249	64360	281	1,33
506255	64775	290	1,33
506257	64775	290	1,33
506263	64785	290	1,33
506265	64785	290	1,33
506267	64785	290	1,33
506366	Capacitor	240	1
506495	Capacitor	240	1
506807	93089	277	15
507049	81018	287	—
507050	81018	287	—
507052	81017	288	—
507053	81017	288	—
507075	83283	293	—
507105	34000	263	1
507181	STr 50/12.342	255	—
507256	Q 250.703	31	1
507341	NaHj 70/50.157	22	1
507342	NaHj 100/70.703	22	1
507343	NaHj 150/100.973	22	1
507490	97257	260,269	—
507498	NaH 50.486	23	1
507562	97677	178	—
507592	97528	74,275	—
507593	97528	74	—
507627	UNaH 150/100.722	37	1
507628	NaHj 100/70.519	23, 37	0
507671	NaHj 100.126	21	1,19
507697	NaHj 70/50.695	23	1
507797	97267	310	—
507798	97267	310	—
507802	83146	301	1
507803	83147	301	1
507936	LN 58.192	150,155	1
508067	97037	284	5
508186	LN 58.116	150,154	1
508245	Q 400.613	31	—
508352	96004	287	—
508353	96004	287	—
508423	28330	185	1
508468	Capacitor	240	1
508484	Capacitor	241	1
508562	97355	277	15
508563	97356	277	15
508590	09407	175	1,3

- 1  ENEC
1a applied
- 2 
- 3  UL US
- 5 
- 7 
- 13 
- 13a 
- 14  VDE
14a applied
- 15 
- 16 
- 17 
- 19 
- 25 
- 28 
- 31 
- 32 
- 33 
- 34 
- 35 
- 36 

Reference Numbers

Ref. No.	Type	Page	Approval
508667	Capacitor	240	1
508668	Capacitor	240	1
508723	NaHJ 250.340	23	1
508741	NaHJ 400.012	28	1
508744	NaHJ 250.011	28	—
508746	Q 250.417	33	1
508922	LN 181.940	149	1
509100	NaHJ 150.355	22	1,19,31
509110	93034	270	—
509117	34301	72	1
509118	93035	270	—
509152	47105	187	1,3,33
509154	47106	187	1,3,33
509156	47304	187	1,3,33
509162	47505	187	1,3,33
509164	47506	187	1,3,33
509169	NaHJ 70.653	22	—
509170	NaHJ 35.638	22	—
509171	NaHJ 150.679	22	—
509213	42000	71	1,3
509263	64307	281	1,33
509295	97355	277	15
509296	97356	277	15
509340	97427	284	17
509349	LN 58.990	150,154	1
509356	31400	70	1,34
509357	33800	268	1,34
509373	L 36.120	151,155	—
509490	NaHJZ 70/50.785	26	15
509491	NaHJZ 100/70.786	26	15
509492	NaHJZ 150/100.787	26	15
509502	LN 26.813	150	1,31
509519	93059	170	—
509520	93058	170	—
509521	93057	170	—
509522	93056	170	—
509613	J 400.027	28	1
520733	97705	282	—
520734	97705	282	—
520735	85074	283	—
520736	85074	283	—
520759	97708	283	—
520760	97708	283	—
520865	30470	263	1,34
520880	94455	269	—
520882	94457	269	—
520992	L 13.210	149,153	—
521010	80280	269	—
521123	84105	196	1,3
525583	97760	269	—
525791	STr 50/12.109	255	—
526169	Capacitor	241	1
526170	Capacitor	241	1
526171	Capacitor	241	1
526196	NaHJ 150.679	21	—
526517	NaHJ 35.485	20	1
526616	NaHJ 150.679	23	—
526715	Q 1000.311	33	—

Ref. No.	Type	Page	Approval
526886	97497	291	—
527191	LN 36.130	150,154	1
527196	LN 36.201	150,155	1
527502	71001	159	1,3,33
527503	71002	159	1,3,33
527504	71003	159	1,3,33
527506	71011	159	1,3,33
527507	71012	159	1,3,33
527508	71013	159	1,3,33
527509	71014	159	1,3,33
527510	71015	159	1,3
527511	71016	159	1,3
527512	71019	159	1,3,33
527529	71101	159	1,3,33
527530	71102	159	1,3,33
527531	71103	159	1,3,33
527533	71111	159	1,3,33
527534	71112	159	1,3,33
527535	71113	159	1,3,33
527536	71114	159	1,3,33
527537	71115	159	1,3
527538	71116	159	1,3
527539	71119	159	1,3,33
527556	71201	161	1,3,33
527557	71202	161	1,3,33
527558	71203	161	1,3,33
527560	71211	161	1,3,33
527561	71212	161	1,3,33
527562	71213	161	1,3,33
527563	71214	161	1,3,33
527564	71215	161	1,3
527565	71216	161	1,3
527566	71219	161	1,3,33
527585	71301	160	1,3,33
527586	71302	160	1,3,33
527587	71303	160	1,3,33
527589	71311	160	1,3,33
527590	71312	160	1,3,33
527591	71313	160	1,3,33
527592	71314	160	1,3,33
527594	71315	160	1,3
527595	71316	160	1,3
527596	71319	160	1,3,33
527735	71501	158	1,3,33
527736	71502	158	1,3,33
527737	71503	158	1,3,33
527739	71511	158	1,3,33
527740	71512	158	1,3,33
527741	71513	158	1,3,33
527742	71514	158	1,3,33
527743	71515	158	1,3
527744	71516	158	1,3
527745	71519	158	1,3,33
527762	71601	162	1,3,33
527763	71602	162	1,3,33
527764	71603	162	1,3,33
527766	71611	162	1,3,33
527768	71612	162	1,3,33





















1	
	ENEC 1a applied
2	
3	
5	
7	
13	
13a	
14	
	VDE 14a applied
15	
16	
17	
19	
25	
28	
31	
32	
33	
34	
35	
36	

1
2
3
4
5
6
7
8
9
10

Reference Numbers

Ref. No.	Type	Page	Approval
527769	71613	162	1,3,33
527770	71614	162	1,3,33
527771	71615	162	1,3
527772	71616	162	1,3
527773	71619	162	1,3,33
527790	71701	161	1,3,33
527791	71702	161	1,3,33
527792	71703	161	1,3,33
527794	71711	161	1,3,33
527795	71712	161	1,3,33
527796	71713	161	1,3,33
527797	71714	161	1,3,33
527798	71715	161	1,3
527799	71716	161	1,3
527800	71719	161	1,3,33
528029	71801	160	1,3,33
528030	71802	160	1,3,33
528031	71803	160	1,3,33
528033	71811	160	1,3,33
528034	71812	160	1,3,33
528035	71813	160	1,3,33
528036	71814	160	1,3,33
528037	71815	160	1,3
528038	71816	160	1,3
528039	71819	160	1,3,33
528116	72101	162,344	1,3,33
528117	72102	162,344	1,3,33
528118	72103	162,344	1,3,33
528120	72111	162,344	1,3,33
528121	72112	162,344	1,3,33
528122	72113	162,344	1,3,33
528123	72114	162,344	1,3,33
528124	72115	162,344	1,3
528125	72116	162,344	1,3
528126	72119	162,344	1,3,33
528128	72131	344	—
528129	72132	344	—
528130	72133	344	—
528131	72134	344	—
528132	72135	344	—
528133	72136	344	—
528134	72139	344	—
528236	Q 400.616	31	1,19
528252	12900	68	15
528253	12910	68	15
528254	12911	68	15
528521	Q 700.035	33	—
528536	NaHJ 1000.089	29	1
528548	NaHJ 1000.089	29	1
528554	Capacitor	241	1
528555	Capacitor	241	1
528582	L 18.121	151,155	1
528761	Q 1000.096	33	1
528886	Q 1000.145	33	1
528958	12901	68	15
529029	LN 36.149	150,154	1
529072	NaHJ 250.163	21	—
529087	NaHJ 250.204	21	1,19





















Ref. No.	Type	Page	Approval
529464	97498	291	—
529560	NaH 600.140	28	—
529599	64740	290	1,33
529665	Capacitor	241	1
529666	Capacitor	241	1
529832	84101	179	1,3
529836	84103	180	—
529841	34311	72	1
529845	34326	72	1
530024	30400	261	1
530025	30450	262	1
530026	30460	262	1
530027	30465	262	1
530079	43520	202	1
530195	NaHJ 100.271	21	—
530252	L 36.158	151,155	14
530509	UNaH 250/150.176	39	0
530878	11000	171	1,3,33
530879	11010	171	1,3,33
530941	LN 18.131	149,150,155	1
531472	VNaHJ 1000.61	16	—
531474	VJD 2000.63	16	—
531475	VNaHJ 400PZT.743	15	—
531476	VNaHJ 250PZT.745	15	—
531480	VNaHJ 1000.61	16	—
531481	VJD 2000.63	16	—
532149	L 18.121	151,155	1
532155	LN 2x18.135	149,154	1
532377	09420	174	1,3
532378	09421	174	1,3
532379	09422	175	1,3
532390	97545	292	—
532391	80023	292	—
532430	13010	77	0
532431	13010	77	0
532602	12800	67,313	1
532603	12801	67,313	1
532604	12810	68,313	1
532605	12811	68,313	1
532606	12812	68,313	1
532610	33906	269	1
532644	L 4/6/8.218	153	—
533043	LN 18.162	150,155	1
533067	LN 30.806	155	—
533312	41500	204	1
533313	41510	204	1
533314	41520	204	1
533315	41540	204	1
533316	41550	204	1
533317	41560	204	1
533391	VNaHJ 35PZTG.050	14	1
533392	VNaHJ 70PZTG.051	14	1
533393	VNaHJ 100PZTG.078	14	—
533394	VNaHJ 150PZTG.052	14	1
533395	NaHJZ 70/50.520	25, 38	1
533396	NaHJZ 100/70.519	25, 38	1
533398	NaHJZ 150/100.466	25, 38	1
533428	12601	67	1

- 1  ENEC
1a applied
- 2 
- 3 
- 5 
- 7 
- 13 
- 13a 
- 14  VDE
14a applied
- 15 
- 16 
- 17 
- 19 
- 25 
- 28 
- 31 
- 32 
- 33 
- 34 
- 35 
- 36 

Reference Numbers

Ref. No.	Type	Page	Approval
533429	12601	67	1
533430	12611	67	1
533431	12611	67	1
533432	12612	67	1
533484	NaH 600.005	28	1,19
533565	NaHJ 150.620	21	1
533568	NaHJ 70.128	20	1
533572	NaHJ 70.128	22	1
533602	NaHJ 150.159	21	1,19
533650	LN 75.170	155	1
533663	37001	71	1
533705	Q 250.606	31	—
533820	64308	281	1,33
533947	UNaH 100/40%.452	36	—
533948	UNaH 150/40%.453	36	—
533949	UNaH 250/40%.454	36	—
534073	84108	179	1,3
534097	97632	310	17
534107	VNaHJ 35PZTG.053	14	1
534109	VNaHJ 70PZTG.054	14	1
534111	VNaHJ 70PZTG.067	14	—
534115	VNaHJ 150PZTG.055	14	1
534117	VNaHJ 150PZTG.068	14	—
534122	VNaHJ 35PZTG.041	14	—
534128	UNaH 70/40%.501	36	—
534218	34515	342	17, 34
534219	34516	342	17, 34
534220	34511	69	1
534252	LN 58.722	150,155	1
534487	NaHJ 1000.089	29	1
534490	LN 24/26.804	149	1
534540	NaHJ 150.620	21	1
534621	L 18.934	149,150,156	—
534624	L18.933	151,155	—
534627	L 18.936	150,155	—
534644	09900	175	1
534689	98013	307	—
534832	62063	299	1
534833	62063	299	1
534948	41530	204	1
534954	41570	204	1
535032	31705	272	1
535034	31755	272	1
535131	02113	200	1
535142	NaHJ 400.743	27	1
535146	30800	262	1
535191	NaHJ 70.128	22	1
535216	NaHJ 150.620	22	1
535247	97742	299,306	—
535263	30800	262	1
535267	95300	262	—
535333	UNaH 150/40%.142	36	—
535347	UNaH 100/40%.522	36	—
535348	UNaH 70/40%.525	36	—
535357	91522	284	—
535474	97734	204	17
535657	VNaHJ 70PZTG.566	13	1
535673	64900	306	—

Ref. No.	Type	Page	Approval
535674	64940	306	—
535684	62061	299	1
535685	62061	299	1
535694	80010	299,306	—
535695	VNaHJ 150PZTG.567	13	1
535750	42200	71	1
535751	42210	71	1
535755	42222	71	1
535778	LN 2x18.135	150,155	1
535783	34525	342	17, 34
535977	L 36.132	150,154	14
535988	30485	263	1
536140	NaHJ 1000.089	29	1
536142	NaHJ 400.743	27	1
536143	NaHJ 400.743	27	1
536144	NaHJ 400.744	27	—
536145	NaHJ 400.743	27	1
536146	NaHJ 400.743	27	1
536147	NaHJ 250.741	27	1
536148	NaHJ 250.741	27	1
536149	NaHJ 250.741	27	1
536150	NaHJ 250.742	27	—
536151	NaHJ 250.741	27	1
536152	NaHJ 250.741	27	1
536164	97765	272	—
536199	VNaHJ 35PZTG.568	13	1
536200	VNaHJ 100PZTG.571	13	—
536201	VNaHJ 35PZTG.568	13	1
536202	VNaHJ 70PZTG.566	13	1
536203	VNaHJ 100PZTG.571	13	—
536204	VNaHJ 150PZTG.567	13	1
536205	VNaHJ 35PZTG.574	13	—
536207	VNaHJ 70PZTG.575	13	—
536209	VNaHJ 150PZTG.576	13	—
536220	12612	67	1
536258	Q 400.801	32	1
536259	Q 400.801	32	1
536260	Q 250.800	32	1
536261	Q 250.800	32	1
536378	Capacitor	239	1
536379	Capacitor	239	1
536380	Capacitor	239	1
536381	Capacitor	239	1
536382	Capacitor	239	1
536383	Capacitor	239	1
536384	Capacitor	239	1
536385	Capacitor	239	1
536386	Capacitor	239	1
536387	Capacitor	239	1
536388	Capacitor	239	1
536389	Capacitor	239	1
536390	Capacitor	239	1
536391	Capacitor	239	1
536392	Capacitor	239	1
536393	Capacitor	239	1
536394	Capacitor	239	1
536395	Capacitor	239	1
536396	Capacitor	239	1





















- 1  ENEC
1a applied
- 2 
- 3 
- 5 
- 7 
- 13 
- 13a 
- 14  VDE applied
- 14a applied
- 15 
- 16 
- 17 
- 19 
- 25 
- 28 
- 31 
- 32 
- 33 
- 34 
- 35 
- 36 

- 1
- 2
- 3
- 4
- 5
- 6
- 7
- 8
- 9
- 10

Reference Numbers

Ref. No.	Type	Page	Approval
536397	Capacitor	239	1
536398	Capacitor	239	1
536399	Capacitor	239	1
536400	Capacitor	239	1
536401	Capacitor	239	1
536402	Capacitor	239	1
536403	Capacitor	239	1
536404	Capacitor	239	1
536405	Capacitor	239	1
536406	Capacitor	240	—
536445	97735	299,306	—
536446	97735	299,306	—
536451	62062	299	1
536452	62062	299	1
536469	31500	70	1
536582	NaHj 70.128	23	1
536593	NaHj 150.620	23	1
536741	Capacitor	241	1
536742	Capacitor	241	1
536743	Capacitor	241	1
536813	Capacitor	241	1
537079	81100	288	—
537080	81100	288	—
537087	83141	288	1
537088	83141	288	1
537103	Q 1000.097	33	1,9
537132	24100	183	1,3
537135	24110	183	1,3
537138	24120	183	1,3
537144	24150	183	1,3
537147	24160	183	1,3
537150	24170	183	1,3
537153	24350	183	1,3
537155	24360	183	1,3
537157	23350	184	1,3
537160	23360	184	1,3
537165	49100	188	1,3
537166	49105	188	1,3
537167	49106	188	—
537173	49500	188	1,3
537174	49505	188	1,3
537175	49506	188	1,3
537181	59100	188	1,3
537182	59105	189	1,3
537183	59106	189	1,3
537205	59500	188	1,3
537206	59505	189	1,3
537207	59506	189	1,3
537403	Str 50/12.109	256	—
537703	Q 400.801	32	1
537726	NaHj 250.741	27	1
537744	L 15.007	155	—
537750	L 30.006	155	—
537763	NaHj 150.620	23	1
537793	NaHj 150.679	21	—
537869	Q 400.715	32	—
537873	Q 400.732	32	—
538034	Q 400.801	32	1





















Ref. No.	Type	Page	Approval
538072	L 361.342	154	1
538089	09700	310	—
538204	NaHj 400.743	27	1
538258	NaHj 35.485	24	1
538262	NaHj 150.620	24	1
538264	NaHj 150.620	24	1
538361	NaHj 70/50.520	22	1
538407	NaHj 70.128	20	1
538537	NaHj 70.653	24	—
538540	Q 1000.096	33	1
538543	NaHj 150.620	22	1
538592	UNaH 400/40%.892	39	—
538620	NaHj 400.744	27	—
538675	PKNaHj 70.128	18	—
538676	PKNaHj 100.941	18	—
538677	PKNaHj 150.620	18	—
538678	PKNaHj 250.741	19	—
538679	PKNaHj 400.743	19	—
538680	PKNaHj 70.653	18	—
538681	PKNaHj 100.271	18	—
538682	PKNaHj 150.679	18	—
538683	PKNaHj 250.742	19	—
538684	PKNaHj 400.744	19	—
538685	PKNaHj 70.128	18	—
538686	PKNaHj 100.941	18	—
538687	PKNaHj 150.620	18	—
538688	PKNaHj 250.741	19	—
538689	PKNaHj 400.743	19	—
538690	PRKUNaH 70/40%.525	34	—
538691	PRKUNaH 100/40%.522	34	—
538692	PRKUNaH 150/40%.142	34	—
538693	PRKUNaH 250/40%.936	35	—
538694	PRKUNaH 400/40%.906	35	—
538695	PRKUNaH 70/40%.525	34	—
538696	PRKUNaH 100/40%.522	34	—
538697	PRKUNaH 150/40%.142	34	—
538698	PRKUNaH 250/40%.936	35	—
538699	PRKUNaH 400/40%.906	35	—
538700	PRKUNaH 70/40%.525	34	—
538701	PRKUNaH 100/40%.522	34	—
538702	PRKUNaH 150/40%.142	34	—
538703	PRKUNaH 250/40%.983	35	—
538704	PRKUNaH 400/40%.937	35	—
538705	PRKUNaH 70/40%.525	34	—
538706	PRKUNaH 100/40%.522	34	—
538707	PRKUNaH 150/40%.142	34	—
538708	PRKUNaH 250/40%.983	35	—
538709	PRKUNaH 400/40%.937	35	—
538710	UNaH 400/40%.906	39	1
538711	UNaH 250/40%.936	39	1
538715	UNaH 400/40%.937	39	—
538801	L 18.249	151,155	14
538807	NaHj 35.485	24	1
538810	NaHj 70.128	24	1
538823	NaHj 70.128	24	1
538828	NaHj 70.653	24	—
538830	NaHj 70.128	23	1
538831	NaHj 150.620	23	1

- 1  ENEC
1a applied
- 2 
- 3 
- 5 
- 7 
- 13 
- 13a 
- 14  VDE
14a applied
- 15 
- 16  TSE Approved
16
- 17 
- 19 
- 25 
- 28  VDE
EMC
- 31  RAM
- 32 
- 33 
- 34  RU US
- 35  ETL RECOGNIZED
COMPONENT
- 36  DEKRA

Reference Numbers

Ref. No.	Type	Page	Approval
538834	NaHJ 150.620	24	1
538843	NaHJ 150.625	24	1
539050	UNaH 150/100.722	37	1
539081	NaHJ 100.581	24	1
539128	23370	184	1,3
539209	NaHJ 400.743	27	1
539212	NaHJ 1000.089	29	1
539223	NaHJ 70.128	24	1
539270	NaHJ 150.355	23	1,19,31
539274	NaHJ 250.741	27	1
539283	UNaH 250/40%.746	39	—
539286	NaHJ 150.620	24	1
539306	NaHJ 150.620	24	1
539311	NaHJ 150.679	24	—
539328	PRKUNaH 70/40%.525	34	—
539329	PRKUNaH 70/40%.525	34	—
539330	PRKUNaH 100/40%.522	34	—
539331	PRKUNaH 100/40%.522	34	—
539332	PRKUNaH 150/40%.142	34	—
539333	PRKUNaH 150/40%.142	34	—
539334	PRKUNaH 250/40%.936	35	—
539335	PRKUNaH 400/40%.906	35	—
539336	PRKUNaH 250/40%.936	35	—
539337	PRKUNaH 400/40%.906	35	—
539384	UNaH 600/40%.060	39	—
539434	NaHJ 70.128	20	1
539492	NaHJ 100.941	22	1
539497	34520	69	1
539515	NaH 50/35.797	23, 37	1
539517	UNaH 250/40%.747	39	—
539609	NaHZ 50/35.797	25	1
542349	NaHJ 250.340	23	1
542557	NaHJ 150.679	24	—
542983	28740	182	1
542984	28741	182	1
543048	85011	276	—
543049	85012	276	—
543053	85013	276	—
543054	85012	276	—
543058	85015	276	—
543059	85016	276	—
543153	31550	343	—
543267	31530	70	1
543295	PKNaHJ 100.345	18	—
543299	PKNaHJ 150.301	18	—
543303	62370	66,299	1
543304	62070	66,298	1
543349	NaHJ 100.941	23	1
543378	PKNaH 50PZT.992	18	—
543384	PRKUNaH 70/40%.525	34	—
543385	PRKUNaH 150/40%.142	34	—
543386	PRKUNaH 250/40%.936	35	—
543388	PRKUNaH 100/40%.522	34	—
543389	PRKUNaH 400/40%.906	35	—
543401	PKNaHJ 35.008	18	—
543414	62415	66,298	1
543615	97765	272	—
543643	42242	71	1

Ref. No.	Type	Page	Approval
543733	VNaH 50PZTG.058	14	—
543737	NaHJ 35.209	22	1
543738	NaH 50.206	22	1
543741	NaHJ 70.226	22	1
543742	PRKUNaH 70/40%.525	34	—
543743	PRKUNaH 100/40%.522	34	—
543744	PRKUNaH 150/40%.142	34	—
543745	PRKUNaH 250/40%.936	35	—
543746	PRKUNaH 400/40%.906	35	—
543747	UNaH 250/40%.936	39	1
543748	UNaH 400/40%.906	39	1
543770	40560	206	1
543771	40561	206	1
543772	40562	206	1
543773	40563	206	1
543777	40566	206	1
543778	40567	206	1
543781	40570	206	1
543782	40571	206	1
543783	40572	206	1
543784	40573	206	1
543787	40576	206	1
543788	40577	206	1
543793	40660	205	1
543794	40661	205	1
543795	40662	205	1
543796	40663	205	1
543800	40666	205	1
543801	40667	205	1
543802	40670	205	7
543803	40671	205	7
543805	40672	205	7
543806	40673	205	7
543809	40676	205	7
543810	40677	205	7
543986	NaHJ 400.743	27	1
544210	NaHJ 250.741	27	1
544605	62009	65,298	1
544621	64800	305	—
544728	UNaH 70/40%.525	37	—
544729	UNaH 150/40%.142	37	—
544730	UNaH 100/40%.522	37	—
544760	PRKUNaH 50/40%.021	34	—
544787	NaHJ 1000.089	29	1
545261	22860	187	1
545262	22861	187	1
545405	LN 26.238	150	1
545840	29125	345	—
545842	29126	345	—
545845	29100	345	—
545849	29101	345	—
545894	09446	177	1,3
545896	09447	177	1,3
545933	09432	176,346	1,3
545935	09433	176,346	1,3
545937	09434	176,346	1,3
545939	09435	176,346	1,3
546006	97745	284	—





















1		ENEC 1a applied
2		
3		
5		
7		
13		
13a		
14		VDE 14a applied
15		
16		
17		
19		
25		
28		
31		
32		
33		
34		
35		
36		

1
2
3
4
5
6
7
8
9
10

Reference Numbers

Ref. No.	Type	Page	Approval
546254	98008	179,196	—
546454	64370	280	1,33
546456	64370	280	1,33
546585	PRKUNaH 250/40%.758	35	—
546641	27700 R	181	1,3
546642	27701 R	181	1,3
546647	27800 R	181	1,3
546648	27801 R	181	1,3
546797	PKNaHJ 35.008	18	—
546817	NaHJ 70.158	23	—
547145	LN 21.293	150	—
547285	PKNaHJ 35.008	18	—
547287	PKNaHJ 70.653	18	—
547761	34510	69	1
548259	NaHJ 400.743	27	1
548260	NaHJ 150.159	24	1,19
549999	31500	70	1
550375	83142	287	1
551271	26300	182,345	1a,3
551272	26310	182,345	1a,3
551275	26302	345	—
551277	26312	345	—
551645	Capacitor	239	—
552774	Capacitor	241	1
553806	NaHZ 50/35.797	26	—
554005	NaHJ 100.213	23	1
554006	NaHJ 150.216	27	1
554270	JD 2000.81	30	—
554283	JD 2000.83	30	—
554303	J 2000.71	30	—
554304	J 2000.72	30	—
554305	J 2000.73	30	—
554306	JD 2000.82	30	—
554307	JD 2000II.91	30	—
554308	JD 2000II.92	30	—
554309	JD 2000I.85	30	—
554310	JD 2000I.86	30	—
554311	J 1200.95	30	—
554312	J 2500.96	30	—
554313	VNaHJ 1000.75	17	—
554314	VJ 2000.76	17	—
554315	VJD 2000.77	17	—
554316	VJD 2000I.78	17	—
554325	STr 200/12.40	257	—
554326	STr 300/12.41	257	—
554542	33650	69	1
554543	33671	69	1
554662	31760	272	1
554904	VNaHJ 1000.75	17	—
554905	VJ 2000.76	17	—
554906	VJD 2000.77	17	—
554909	VJD 2000I.78	17	—
560657	INN 18.645	152	—
560659	INN 18.646	152	—
560661	INN 18.647	152	—
560664	INN 18.648	152	—
560665	INN 58TD.649	152	—
562450	NaHJ 150.166	23	1

Ref. No.	Type	Page	Approval
562658	INN 9/11.015	148	1a
563039	NaHJ 70.226	23	1
563416	VNaHJ 70PZTG.203	13	—
563417	VNaHJ 100PZTG.202	13	—
563870	NaHJ 70/50.411	37	—
563871	NaH 50/35.412	23, 37	—
563872	UNAH 70/40%.413	37	—
563873	UNAH 100/40%.41	37	—
563874	UNAH150/40%.922	37	—
563876	NaHJ 150/100.923	23, 37	—
564135	64314	281	1
564189	INN 2X18.043	149,152,154	1a
564190	INN 13.044	148,152,153	1a
564191	INN 30.045	152,154	1a
564192	INN 18I.046	149,152	1a
564680	64770	294	—
564681	64770	294	—
554314	VJ 2000.76	17	—
554315	VJD 2000.77	17	—
554316	VJD 2000I.78	17	—
554325	STr 200/12.40	265	—
554326	STr 300/12.41	265	—
554542	33650	69	1
554543	33671	69	1
554662	31760	280	1
554904	VNaHJ 1000.75	17	—
554905	VJ 2000.76	17	—
554906	VJD 2000.77	17	—
554909	VJD 2000I.78	17	—
560657	INN 18.645	154	—
560659	INN 18.646	154	—
560661	INN 18.647	154	—
560664	INN 18.648	154	—
560665	INN 58TD.649	154	—
562450	NaHJ 150.166	23	1
562658	INN 9/11.015	150	1a
563039	NaHJ 70.226	23	1
563416	VNaHJ 70PZTG.203	13	—
563417	VNaHJ 100PZTG.202	13	—
563870	NaHJ 70/50.411	37	—
563871	NaH 50/35.412	23, 37	—
563872	UNAH 70/40%.413	37	—
563873	UNAH 100/40%.41	37	—
563874	UNAH150/40%.922	37	—
563876	NaHJ 150/100.923	23, 37	—
564135	64314	289	1
564189	INN 2X18.043	151, 154, 156	1a
564190	INN 13.044	150, 154, 155	1a
564191	INN 30.045	154, 156	1a
564192	INN 18I.046	151, 154	1a
564680	64770	302	—
564681	64770	302	—

- 1  ENEC
1a applied
- 2 
- 3 
- 5 
- 7 
- 13 
- 13a 
- 14  VDE
14a applied
- 15 
- 16  TUV Approved
16a applied
- 17 
- 19 
- 25 
- 28 
- 31 
- 32 
- 33 
- 34 
- 35 
- 36 

Subsidiaries

Subsidiaries	Adress	Phone / Fax / Email
Vossloh-Schwabe Deutschland GmbH Germany, Benelux, CIS, Georgia, Great Britain, Ireland, Austria, Switzerland, Scandinavia, Turkey, Ukraine	P.O. Box 28 69 D-58478 Lüdenscheid, Germany	Phone: +49/(0)2351/10 10 Fax: +49/(0)2351/10 12 17 info.vsv@vsv.vossloh-schwabe.com
Australia Vossloh-Schwabe Deutschland GmbH	Branch Office Sydney Unit 4C, 6 Boundary Road Northmead, NSW, 2152, Australia	Phone: +61/(0)2/88 43 07 00 Fax: +61/(0)2/88 43 07 77 sales-aus@vsv.vossloh-schwabe.com
China Vossloh-Schwabe Hong Kong Ltd. (Shanghai Office)	Room 2935, Capitaland, HuMin Road, Xinzhuang, Minhang Shanghai, 201199, China	Phone: +852/2877 9688 Fax: +852/2877 9933 ryan.gao@vshk.vossloh-schwabe.com
France Vossloh-Schwabe Deutschland GmbH	Branch Office France 10 Rue Denis Papin CS50101 68025 Colmar, France	Phone: +33/(0)389/20 12 12 Fax: +33/(0)389/24 18 65 vsf.ventes@vsf.vossloh-schwabe.com
Hong Kong Vossloh-Schwabe Hong Kong Ltd.	Room B5, 17/F., TML Tower 3 Hoi Shing Road, Tsuen Wan, N.T., Hong Kong	Phone: +852/2877 9688 Fax: +852/2877 9933 sales.vshk@vshk.vossloh-schwabe.com
Italy Vossloh-Schwabe Italia S.p.A.	Via Strada S. Martino 15 47027 Sarsina/Farfi-Cesena, Italy	Phone: +39/0547/9 81 11 Fax: +39/0547/9 82 60 vs-i@vsi.vossloh-schwabe.com
Korea Vossloh-Schwabe Korea	#605 Cosmo Tower Building 416 Youngdongdaero, Gangnam-gu Seoul 135-549, Korea	Phone: +82 2 3484 6611~6 Fax: +82 2 3484 6617 sales.vskr@vs.vossloh-schwabe.com
New Zealand Vossloh-Schwabe Deutschland GmbH	Branch Office Auckland P.O. Box 58809 2163 Botany, Manukau / New Zealand	Phone: +64/(0)9/265 11 10 Fax: +64/(0)9/265 11 20 sales-nz@vsnz.vossloh-schwabe.com
Poland, Baltic States, Czech Republic Vossloh-Schwabe Deutschland GmbH	Sales office Poland ul. Dr. Jana Piltza 48/15 PL 30392 Krakow Poland	Phone: +48 12 357 23 23 Fax: +48 12 262 03 26 lukasz.niemczycki@vsv.vossloh-schwabe.com marcin.niemczycki@vsv.vossloh-schwabe.com
Serbia, Albania, Bosnia-Herzegovina, Bulgaria, Croatia, Greece, Kosovo, Macedonia, Montenegro, Cyprus Vossloh-Schwabe Deutschland GmbH	Sales Office Belgrad/Serbia Danila Lekica 1 11000 Belgrade, Serbia	Phone: +381/63/286 330 Fax: +381/63/286 330 goran.stankovic@vsv.vossloh-schwabe.com
Singapore Vossloh-Schwabe Pte. Ltd.	No. 33 Ubi Avenue 3 #06-72 Vertex Tower A Singapore 408868	Phone: +65/6275 7533 Fax: +65/6275 7633 sales.vsf@vsfe.vossloh-schwabe.com
Slovakia, Hungary, Slovenia Vossloh-Schwabe Deutschland GmbH	Sales office Slovakia Priemyselná 5 917 01 Trnava, Slovakia	Phone: +386 51 261 605 dejan.hergan@vsv.vossloh-schwabe.com
South Africa Vossloh-Schwabe Deutschland GmbH	Branch Office Johannesburg 154, Lechwe Avenue, Corporate Park Midrand 1685, South Africa	Phone: +27/11/31 44 340 Fax: +27/11/31 45 287 barry.hall@vsaf.vossloh-schwabe.com
Spain, South America, Portugal Vossloh-Schwabe Ibérica, S.L.	Venezuela 105, 5° - A 08019 Barcelona, Spain	Phone: +34/93/481 70 70 Fax: +34/93/481 70 71 vs-e@vse.vossloh-schwabe.com
Taiwan Vossloh-Schwabe Pte. Ltd.	Taiwan Branch 9FL-2, No. 80, Sung Chiang Road Taipei, Taiwan 10456	Phone: +886-2/2568 3622 Fax: +886-2/2568 3620 sales.vstw@vstw.vossloh-schwabe.com
Thailand Vossloh-Schwabe Trading Ltd.	3rd Floor, Unit 1, Bangkok Union Insurance Bldg. 175-177 Surawong Road, Kwaeng Suriyawong Khet Bangrak, Bangkok 10500, Thailand	Phone: +66 02634-7311 Fax: +66 02634-7313 sales.vstt@vstt.vossloh-schwabe.com
Tunisia Vossloh-Schwabe Tunisie S.A.	Rue de l'énergie, BP. 299 Zone Industrielle de Ben Arous 2013 Tunis, Tunisia	Phone: +216/71/384 900 Fax: +216/71/384 990 hatem.benyahmed@vstu.com.tn
USA, Canada, Mexico Universal™ Lighting Technologies	26 Century Blvd. Nashville, TN 37214-3683, USA	Phone: +1/615/316-5100 Fax: +1/615/316-5205 oem_sales@unvlt.com

Whenever an electric light goes on around the world, Vossloh-Schwabe is likely to have made a key contribution to ensuring that everything works at the flick of a switch.

Headquartered in Germany, Vossloh-Schwabe has been a member of the global Panasonic group since 2002 and counts as a technology leader within the lighting sector. Top-quality, high-performance products form the basis of the company's success.

Whether cost-effective standard components or tailor-made product developments are needed, Vossloh-Schwabe can satisfy even the most diverse market and customer requirements. Vossloh-Schwabe's extensive product portfolio covers all lighting components: LED systems with matching control gear units and state-of-the-art control systems (LiCS) as well as electronic and magnetic ballasts and lampholders.



A member of the Panasonic group **Panasonic**

Vossloh-Schwabe Deutschland GmbH

Hohe Steinert 8 · 58509 Lüdenscheid · Germany
Phone +49/23 51/10 10 · Fax +49/23 51/10 12 17

www.vossloh-schwabe.com

VS LIGHTING SOLUTIONS

All rights reserved © Vossloh-Schwabe
Photos: istockphoto.com; shutterstock.com
Specifications are subject to change without notice
VS Component Systems Standard EN 2017-1