

Single relay - REL-MR- 24DC/21 - 2961105

Please be informed that the data shown in this PDF Document is generated from our Online Catalog. Please find the complete data in the user's documentation. Our General Terms of Use for Downloads are valid (<http://phoenixcontact.com/download>)



Plug-in miniature power relay, with power contact, 1 PDT, input voltage 24 V DC

Why buy this product

- Safe isolation according to DIN EN 50178 between coil and contact
- High degree of protection up to RT III depending on type (wash-proof)
- Power contacts up to 6 A



Key Commercial Data

Packing unit	1 STK
Minimum order quantity	10 STK
GTIN	 4 017918 130893
GTIN	4017918130893
Weight per Piece (excluding packing)	6.000 g
Custom tariff number	85364190
Country of origin	Czech Republic

Technical data

Dimensions

Width	5 mm
Height	28 mm
Depth	15 mm

Ambient conditions

Ambient temperature (operation)	-40 °C ... 85 °C
---------------------------------	------------------

Single relay - REL-MR- 24DC/21 - 2961105

Technical data

Ambient conditions

Ambient temperature (storage/transport)	-40 °C ... 85 °C
-----------------------------------------	------------------

Coil side

Nominal input voltage U_N	24 V DC
Input voltage range in reference to U_N	see diagram
Typical input current at U_N	7 mA
Typical response time	5 ms
Typical release time	2.5 ms
Coil resistance	3390 Ω \pm 10 % (at 20 °C)
Power dissipation for nominal condition	0.17 W

Contact side

Contact type	1 PDT
Type of switch contact	Single contact
Contact material	AgSnO
Maximum switching voltage	250 V AC/DC
Minimum switching voltage	5 V (at 100 mA)
Min. switching current	10 mA (at 12 V)
Maximum inrush current	10 A (4 s)
Limiting continuous current	6 A
Interrupting rating (ohmic load) max.	140 W (at 24 V DC)
	20 W (at 48 V DC)
	18 W (at 60 V DC)
	23 W (at 110 V DC)
	40 W (at 220 V DC)
	1500 VA (for 250 V AC)
Switching capacity in acc. with DIN VDE 0660/IEC 60947	2 A (at 24 V, DC13)
	0.2 A (at 110 V, DC13)
	0.1 A (at 220 V, DC13)
	3 A (at 24 V, AC15)
	3 A (at 120 V, AC15)
	3 A (at 230 V, AC15)

General

Test voltage relay winding/relay contact	4 kV AC (50 Hz, 1 min.)
Operating mode	100% operating factor
Degree of protection	RT III (wash-proof)
Mechanical service life	2 x 10 ⁷ cycles
Standards/regulations	IEC 60664

Single relay - REL-MR- 24DC/21 - 2961105

Technical data

General

	EN 50178
	IEC 62103
	EN 61810-1
Degree of pollution	3
Overvoltage category	III
Mounting position	any
Assembly instructions	In rows with zero spacing

Standards and Regulations

Connection in acc. with standard	CUL
Standards/regulations	IEC 60664
	EN 50178
	IEC 62103
	EN 61810-1
Degree of pollution	3
Overvoltage category	III

Drawings

Drilling diagram

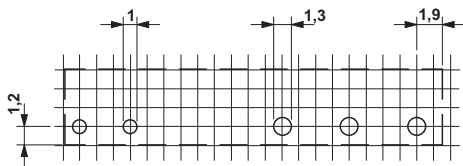

a = pitch division 1.25 mm and 1.27 mm

Diagram

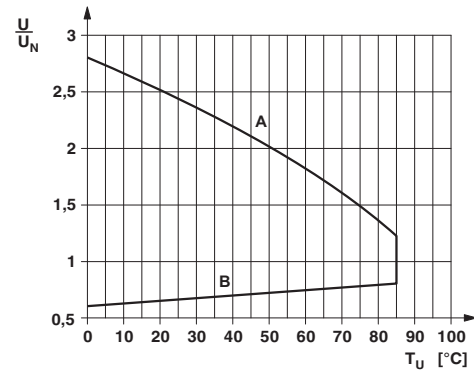

Single relay - REL-MR- 24DC/21 - 2961105

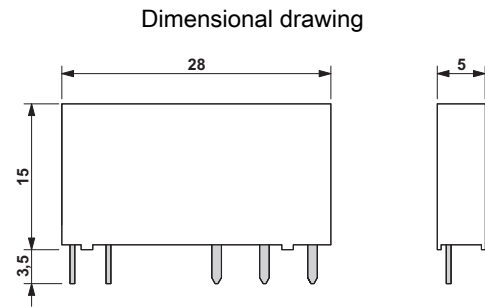
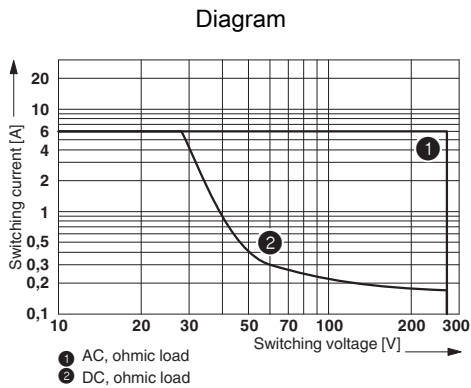

Interrupting rating

Circuit diagram

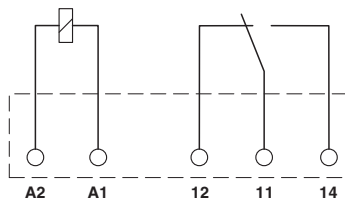

Classifications

eCl@ss

eCl@ss 4.0	27371104
eCl@ss 4.1	27371104
eCl@ss 5.0	27371601
eCl@ss 5.1	27371601
eCl@ss 6.0	27371601
eCl@ss 7.0	27371601
eCl@ss 8.0	27371601
eCl@ss 9.0	27371601

ETIM

ETIM 2.0	EC001437
ETIM 3.0	EC001437
ETIM 4.0	EC001437
ETIM 5.0	EC001437

Single relay - REL-MR- 24DC/21 - 2961105

Classifications

UNSPSC

UNSPSC 6.01	30211916
UNSPSC 7.0901	39121515
UNSPSC 11	39121515
UNSPSC 12.01	39121515
UNSPSC 13.2	39121515

Approvals

Approvals

Approvals

UL Recognized / VDE Zeichengenehmigung / cUL Recognized / GL / EAC / EAC / UL Recognized / cUL Recognized / VDE approval of drawings / PRS / cULus Recognized

Ex Approvals

Approval details

UL Recognized  <http://database.ul.com/cgi-bin/XYV/template/LISEXT/1FRAME/index.htm> FILE E 172140

VDE Zeichengenehmigung  <http://www.vde.de> 40032864

cUL Recognized  <http://database.ul.com/cgi-bin/XYV/template/LISEXT/1FRAME/index.htm> FILE E 172140

GL <http://www.gl-group.com/newbuilding/approvals/index.html> 46016-03 HH

EAC EAC-Zulassung

EAC 7500651.22.01.00244

Single relay - REL-MR- 24DC/21 - 2961105

Approvals

UL Recognized  <http://database.ul.com/cgi-bin/XYV/template/LISEXT/1FRAME/index.htm> FILE E 172140

cUL Recognized  <http://database.ul.com/cgi-bin/XYV/template/LISEXT/1FRAME/index.htm> FILE E 172140

VDE approval of drawings  <http://www.vde.de> 40010212

PRS <http://www.prs.pl/TE/2109/880590/16>

cULus Recognized  <http://database.ul.com/cgi-bin/XYV/template/LISEXT/1FRAME/index.htm>

Accessories

Additional products

Relay socket - PLC-BPT- 24DC/21 - 2900445



6.2 mm PLC basic terminal block with push-in connection, without relay or solid-state relay, for mounting on DIN rail NS 35/7,5, 1 PDT, input voltage 24 V DC

Relay socket - PLC-BSP- 24DC/21 - 2967219



6.2 mm PLC basic terminal block with spring-cage connection, without relay or solid-state relay, for mounting on DIN rail NS 35/7,5, 1 PDT, input voltage 24 V DC

Single relay - REL-MR- 24DC/21 - 2961105

Accessories

Relay socket - PLC-BSC- 24DC/21 - 2966016



6.2 mm PLC basic terminal block with screw connection, without relays or solid-state relay, for mounting on DIN rail NS 35/7,5, 1 PDT, input voltage 24 V DC

Relay socket - PLC-BPT- 24UC/21 - 2900446



6.2 mm PLC basic terminal block with push-in connection, without relay or solid-state relay, for mounting on DIN rail NS 35/7,5, 1 PDT, input voltage 24 V AC/DC

Relay socket - PLC-BSP- 24UC/21 - 2967222



6.2 mm PLC basic terminal block with spring-cage connection, without relay or solid-state relay, for mounting on DIN rail NS 35/7,5, 1 PDT, input voltage 24 V AC/DC

Relay socket - PLC-BSC- 24UC/21 - 2966029



6.2 mm PLC basic terminal block with screw connection, without relay or solid-state relay, for mounting on DIN rail NS 35/7,5, 1 PDT, input voltage 24 V AC/DC

Basic terminal block - PLC-BSC- 36DC/21 - 2966964

Basic terminal block

Single relay - REL-MR- 24DC/21 - 2961105

Accessories

Relay socket - PLC-BPT- 48DC/21 - 2900447



6.2 mm PLC basic terminal block with push-in connection, without relay or solid-state relay, for mounting on DIN rail NS 35/7,5, 1 PDT, input voltage 48 V DC

Relay socket - PLC-BSP- 48DC/21 - 2967329



6.2 mm PLC basic terminal block with spring-cage connection, without relay or solid-state relay, for mounting on DIN rail NS 35/7,5, 1 PDT, input voltage 48 V DC

Relay socket - PLC-BSC- 48DC/21 - 2966090



6.2 mm PLC basic terminal block with screw connection, without relay or solid-state relay, for mounting on DIN rail NS 35/7,5, 1 PDT, input voltage 48 V DC

Relay socket - PLC-BPT- 24DC/ 1/SEN - 2900262



6.2 mm PLC basic terminal block for input functions with push-in connection, without relay or solid-state relay, for mounting on DIN rail NS 35/7,5, with sensor supply voltage distribution (BB), 1 N/O contact, input voltage 24 V DC

Relay socket - PLC-BSP- 24DC/ 1/SEN - 2967206



6.2 mm PLC basic terminal block for input functions with spring-cage connection, without relay or solid-state relay, for mounting on DIN rail NS 35/7,5, with sensor supply voltage distribution (BB), 1 N/O contact, input voltage 24 V DC

Single relay - REL-MR- 24DC/21 - 2961105

Accessories

Relay socket - PLC-BSC- 24DC/ 1/SEN - 2966061



6.2 mm PLC basic terminal block for input functions with screw connection, without relay or solid-state relay, for mounting on DIN rail NS 35/7,5, with sensor supply voltage distribution (BB), 1 N/O contact, input voltage 24 V DC

Relay socket - PLC-BPT- 24UC/ 1/ACT - 2900450



6.2 mm PLC basic terminal block for output functions with push-in connection, without relay or solid-state relay, for mounting on DIN rail NS 35/7,5, with load return line connection (BB), 1 N/O contact, input voltage 24 V AC/DC

Relay socket - PLC-BSP- 24UC/ 1/ACT - 2982809



6.2 mm PLC basic terminal block for output functions with spring-cage connection, without relay or solid-state relay, for mounting on DIN rail NS 35/7,5, with load return line connection (BB), 1 N/O contact, input voltage 24 V AC/DC

Relay socket - PLC-BSC- 24UC/ 1/ACT - 2982799



6.2 mm PLC basic terminal block for output functions with screw connection, without relay or solid-state relay, for mounting on DIN rail NS 35/7,5, with load return line connection (BB), 1 N/O contact, input voltage 24 V AC/DC

Relay socket - PLC-BSC- 24DC/21/SO46 - 2980458



6.2 mm PLC basic terminal block with protection against interference currents and interference voltages on the control side, with screw connection, without relay or solid-state relay, for mounting on NS 35/7,5 DIN rail, with increased input current consumption, 1 PDT, 24 V DC input voltage

Single relay - REL-MR- 24DC/21 - 2961105

Accessories

Relay socket - RIF-0-BPT/21 - 2900958



RIF-0... relay base, for miniature power relay with 1 PDT or solid-state relays of the same design, push-in connection, for mounting on NS 35/7,5

Phoenix Contact 2016 © - all rights reserved
<http://www.phoenixcontact.com>