

KAVLICO PRESSURE SENSORS PRODUCT OVERVIEW

KAVLICO MISSION STATEMENT

At Kavlico Pressure Sensors, designing and developing pressure sensors for mission critical applications is our focus and specialty.

Our strength lies in our ability to apply our state-of-the-art pressure sensing and signal treatment technologies such as:

- Thin Film,
- Ceramic Capacitive,
- Piezo-resistive and
- Silicon Capacitive

to meet any application specific requirement and provide perfect package expertise to adapt to customer specifications.

We are using an extensive network of development and support functions to design, develop, validate, and manufacture pressure sensors to fit the highest quality requirements in the harschest environments.

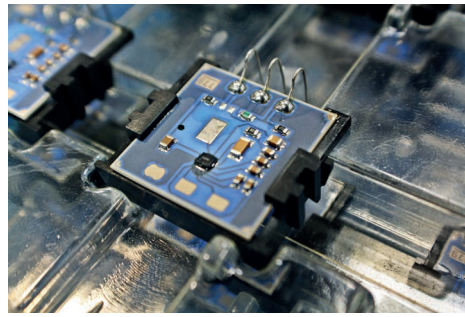

CUSTOMIZATION EXPERTISE

Kavlico's customization team is a dedicated and highly qualified engineering team, adapting our pressure sensors to meet customer specific requirements.

Extended by the latest testing and analysis capabilities, Kavlico Pressure Sensors' customization team is offering exclusive designs tailored for unique applications.

Kavlico Pressure Sensors - The right sensor for your application!

Customization Features

- Pressure Range
- Pressure References
(Absolute, Gage, Seal Gage & Differential*)
- Pressure Fittings Port
- Output
(Voltage, Current*, Frequency*)
- Electrical Connectors
- Media Seal
- Cable Assemblies

Test Capabilities

- BCI Enclosure
- Constant Temp Exposure
- EMI Tester
- ESD Generator
- Force & Hardnes Tester
- TEM Cell & GTEM Chambers
- Salt Spray / Fog Chamber
- Temperature / Vibration Tester
- Temperature Cycling & Humidity Chamber
- Thermal Shock Chamber Air to Air
- Thermal Shock Liquid to Liquid
- 3D Measurement Machine
- Differential Scanning Calorimetry

Analysis Capabilities

- Energy Dispersive X-Ray Spectrometer
- Fourier Transform Infrared Spectrometer
- Real Time X-Ray Vision Machine
- Residual Dirt Analyses
- Scanning Electron Microscope
- X-ray Package Analyser
- Thermo Gravimetical Analyzer

* Available on selected models

PRESSURE MEASUREMENT METHODS

REFERENCE

Gage (G) Pressure



Sealed Gage (SG) Pressure



Differential (DP) Pressure



Absolute (A) Pressure



APPLICATION EXAMPLE



PRESSURE MEASUREMENT DEVICES

Pressure Sensors

Today many measuring principles are used in electronic pressure measurement instruments. Most methods are based on the measurement of a displacement or force.

This pressure sensor is the basis of electronic pressure measurement systems. While mechanical Gage element displacements of between 0.004 and 0.012 inches are standard, the deformations in electronic pressure sensors amount to no more than a few microns.

Thanks to this minimal deformation, electronic pressure measurement instruments have excellent dynamic characteristics and low material strain resulting in high resistance to alternating loads and long-term durability.

Pressure Transducers

Pressure transducers are an advanced form of the pressure sensor element. The simplest form of an electronic pressure measurement system is the pressure sensor. It is the pressure sensor which changes the physical variable pressure into a quantity that can be processed electronically.

A pressure transducer is the next level of sophistication. In a pressure transducer, the sensor element and housing are in electrical contact and have a Pressure Connections.

Typical output signals from pressure transducers are between 10 mV and around 100mV, depending on the sensor type. These signals are not standardized, however, nor are they compensated. With thin-film type pressure transducers it is customary for just the sensor element to be welded to the Pressure Connections and then bonded electrically.

Piezoresistive pressure transducers, on the other hand, require far more production steps since the semiconductor sensor element has to be protected from the various media by a chemical seal.

Pressure Transmitters

Pressure Transmitters, a sub-group of pressure transducers, feature additional reset and calibration options. With some sensor types it is possible:

- to re-set the measuring span over large ranges. This calibration option is usually referred to by such terms as scale down, span reset or turn down.

- to shift the zero point over a wide range and to calibrate the damping of the output signal between 0 and 32 seconds. Smart transmitters such as Hart®, which also have logging capabilities, can be calibrated, tested and reset via the control desk or hand terminals. Transmitters are often used in process applications where they can be combined with various chemical seals.

MARKETS

With extensive experience and a long term commitment to innovation, Kavlico Pressure Sensors is the trusted source to design, develop, and manufacture robust and reliable sensors for mission critical applications in the most demanding global markets.

For over half a century, Kavlico Pressure Sensors has been successfully addressing the pressure, fluid level, and specialty sensors needs of customers in the following markets:



Transportation



Building Equipment



Food and Beverages



Commercial OEMs



Industrial OEMs



Energy & Infrastructure



Medical



Aerospace & Defense

PRODUCT SELECTION GUIDE

Select the product that fits your needs!

Technology	Page	Product	Pressure Range	Transportation	Building Equipment	Food & Beverages	Commercial	Industrial	Energy & Infrastructure
Thin Film Pressure Sensors	10	PTE5000	Bar	x		x	x	x	x
	12	PTA5000	PSI	x		x	x	x	x
	14	P1E	Bar		x		x	x	
Ceramic Capacitive Pressure Sensors	16	P1A	Bar & PSI	x	x	x	x	x	x
	18	P500	Bar & PSI	x	x	x	x	x	x
	20	P528	Bar & PSI	x	x	x	x	x	x
	22	P265	PSI	x		x	x	x	x
	24	PS312	Bar		x	x	x	x	x
	26	PS162	Bar		x	x	x	x	x
	28	PE2000	Bar & PSI	x	x		x	x	
	30	P321	PSI	x	x		x	x	
Piezo-Resistive Pressure Sensors	32	P6000	Bar & PSI		x		x	x	
	34	P4000	Bar & PSI	x	x		x	x	x
	36	P4055	PSI	x	x	x	x	x	x
	38	P4056	PSI	x	x	x	x	x	x
	40	P1J	Bar & PSI		x		x	x	
Silicon Capacitive Pressure Sensors	42	P1K	Bar & PSI		x		x	x	
	44	P992	Bar & PSI		x		x	x	
	46	P993	Bar & PSI		x		x	x	

PTE5000

Hermetically Sealed Modular Pressure Sensor

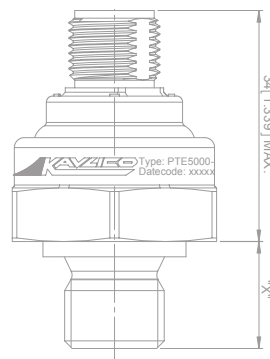
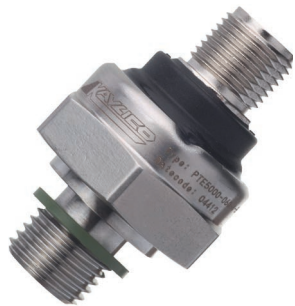

Main Features

Pressure Ranges	0 - 6 up to 0 - 600 Bar
Pressure Connections	G1/4" male, 1/4"-18NPT, 7/16"-20UNF-2A or 2B with Schrader Deflator
Electrical Connection	M12-4 Pole, DIN175301-803A, DIN175301-803-C Packard Metri-Pack 150
Housing Material	304 Stainless Steel (1.4301)
Output Signal	4 - 20 mA, 0 - 10 VDC, 0.5 - 4.5 VDC ratiometric

For further options, please see Main Options

Attributes

- Hermetically Sealed
- Rugged & Durable
- Compact & Light-weight
- Resistant to Chemical Attack
- Superior Long-Term Stability & Repeatability
- Outstanding Shock & Vibration Performance

Typical Applications

- Compressors
- Hydraulic Systems
- Agricultural Equipment
- Construction Equipment
- Heat Pumps
- Chemical Industry

PTE5000 - MAIN OPTIONS

Pressure Ranges

0 - 6 Bar	0 - 100 Bar
0 - 10 Bar	0 - 160 Bar
0 - 16 Bar	0 - 250 Bar
0 - 25 Bar	0 - 400 Bar
0 - 40 Bar	0 - 600 Bar
0 - 60 Bar	

Pressure References

- Gage

Output

- 4 - 20 mA
- 0.5 - 4.5 VDC Ratiometric
- 0 - 5 VDC
- 0 - 10 VDC

External Seal Material

- Fluorocarbon FKM (Viton®) Seal Material*
- Aluminium Washer G1/4"***
- Copper Washer G1/4"***

* only for pressure port option G1/4" A DIN 3852-E

** only for pressure port option G1/4" A DIN 3852-A

Pressure Connections

- G1/4" A DIN 3852-E
- 7/16"-20 UNF-2B (female) SAE J1926/1 (modified) w/ 45° Cone and Schrader deflator (for pressure range 006 - 060)
- 7/16"-20 UNF-2A (male) SAE J1926/2 (modified) w/ 45° Cone
- G1/4" A DIN 3852-A

Built-in Electrical Connections

- Compatible with DIN 175301-803 A (18 mm)
- GDS 307 Industrial Standard (9.4 mm)
- M12-4 pole
- Packard Metri-Pack 150

PTA5000

Hermetically Sealed Modular Pressure Sensor

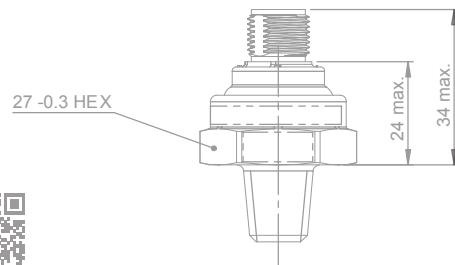

Main Features

Pressure Ranges	0 - 6 up to 0 - 600 Bar
Pressure Connections	1/4 - 18 NPT
Electrical Connection	M12-4 Pole, Packard Metri-Pack 150
Housing Material	304 Stainless Steel (1.4301)
Output Signal	4 - 20 mA, 0 - 10 VDC, 0.5 - 4.5 VDC ratiometric

For further options, please see Main Options

Attributes

- Hermetically Sealed
- Rugged & Durable
- Compact & Light-weight
- Resistant to Chemical Attack
- Superior Long-Term Stability & Repeatability
- Outstanding Shock & Vibration Performance

Typical Applications

- Compressors
- Hydraulic Systems
- Agricultural Equipment
- Construction Equipment
- Heat Pumps
- Chemical Industry

PTA5000 - MAIN OPTIONS

Pressure Ranges

0 - 100 PSI	0 - 2000 PSI
0 - 150 PSI	0 - 3000 PSI
0 - 200 PSI	0 - 6000 PSI
0 - 300 PSI	0 - 9000 PSI
0 - 600 PSI	0 - 10000 PSI
0 - 1000 PSI	

Pressure References

- Gage

Output

- 4 - 20 mA
- 0.5 - 4.5 VDC Ratiometric
- 0 - 10 VDC

Pressure Connections

- 1/4 - 18 NPT

Built-in Electrical Connections

- M12 - 4 pole
- Packard Metri-Pack 150

P1E Pressure Sensor for Oxygen Services



ISO 15001 Certified

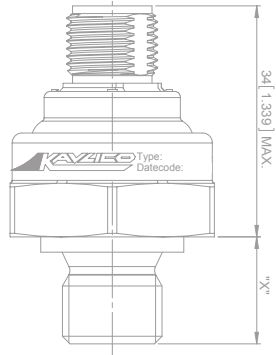

Main Features

Pressure Ranges	0 - 10 up to 0 - 400 Bar (Gage)
Pressure Connections	G1/4"A DIN 3852-A
Electrical Connection	M12-4 Pole, DIN175301-803A , GDS 307 Industrial Standard
Housing Material	304 Stainless Steel (1.4301)
Output Signal	4 - 20 mA

For further options, please see Main Options

Attributes

- Hermetically Sealed
- Wetted Parts Free of Oil & Grease
- Compact & Light-weight
- Resistant to Chemical Attack
- Superior Long-Term Stability & Repeatability
- Outstanding Shock & Vibration performance

Typical Applications

- Medical Gas Storage
- Oxygen Delivery Systems
- Nitrogen and Oxygen Plants
- Medical Air Plant Sector
- Medical Gas Control

P1E - MAIN OPTIONS

Pressure Ranges

- 0 - 10 Bar
- 0 - 16 Bar
- 0 - 25 Bar
- 0 - 100 Bar
- 0 - 250 Bar
- 0 - 400 Bar

Pressure References

- Gage

External Seal Material

- None
- Fluorocarbon FKM (Viton®) Seal Material
- Aluminium washer G1/4"
- Copper washer G1/4"

Pressure Connections

- G1/4A DIN 3852-A

Built-in Electrical Connections

- Compatible with DIN 175301-803 A (18 mm)
- GDS 307 Industrial Standard (9.4 mm)
- M12 - 4 pole
- Packard Metri-Pack 150

P1A Pressure Sensor

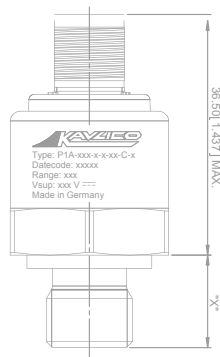
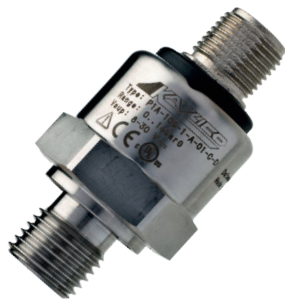

Main Features

Pressure Ranges	0 - 0.25 up to 0 - 16 and -1 - 0 up to -1 - 1 bar (gauge) 0 - 1.6 up to 0 - 16 bar (absolute)
Pressure Connections	G1/4A DIN 3852-E or -A, 7/16"-20 UNF-2A or -2B with Schrader Deflator
Electrical Connection	M12-4 Pole, DIN175301-803A Packard Metri-Pack 150
Housing Material	304 Stainless Steel (1.4301)
Output Signal	4 - 20 mA, 0 - 10 VDC, 0.5 - 4.5 VDC ratiometric

For further options, please see Main Options

Attributes

- Small Compact Size
- Highly Modular Product Configurations
- Kavlico Ceramic Capacitive Technology
- Outstanding Long Term Stability and Performance
- Media Resistant CCAP Technology

Typical Applications

- Vacuum Machinery and Plant
- Medical and Laboratory Sterilizers
- HVAC Systems
- Pneumatic Systems
- Waste Pumps and Water Management
- Industrial OEM Applications

P1A - MAIN OPTIONS

Pressure Ranges

0 - 0.25 Bar*	0 - 16 Bar	0 - 75 PSI
0 - 0.4 Bar*	-1 - 0 Bar*	0 - 100 PSI
0 - 0.6 Bar*	-1 - 1 Bar*	0 - 150 PSI
0 - 1 Bar*	0 - 5 PSI*	0 - 200 PSI
0 - 1.6 Bar	0 - 10 PSI*	
0 - 2.5 Bar	0 - 15 PSI*	
0 - 4 Bar	0 - 20 PSI*	
0 - 6 Bar	0 - 30 PSI	*in gage only
0 - 10 Bar	0 - 50 PSI	

Pressure References

- Absolute
- Gage

Output

- 4 - 20 mA
- 0.5 - 4.5 VDC ratiometric
- 0-5 VDC
- 0 - 10 VDC

External Seal Material

- Fluorocarbon - FKM (Viton®) Only for Pressure Connections pG 1/4A DIN 3852-E lower temperature limited to -20°C
- Fluorosilicone - FVMQ
- Ethylene Propylene - EPDM

Pressure Connections

- G 1/4A DIN 3852-E
- 7/16-20UNF-2B (Female) SAE J1926-1 (Modified); with 45° cone and schrader deflator
- 7/16-20UNF-2A (Male) SAE J1926-2 (Modified); with 45° cone
- G1/4A DIN 3852-A
- 1/4-19 BSPT is equivalent to 1/4-19PT and R1/4-19 per DIN EN 10226
- 1/4-18 NPT (Male)
- 1/8-27 NPT (Male)

Built-in Electrical Connections

- 18mm, EN 175301-803-A003MS, 4 pole
- M12, 4 pole according to IEC 61076-2-101
- Packard Metri-Pack 150, 3 pole Sensor

Internal Seal Material

- Neoprene - CR
- Fluorocarbon - FKM (Viton®)
- Fluorosilicone - FVMQ
- Ethylene Propylene - EPDM

P500 Pressure Sensor

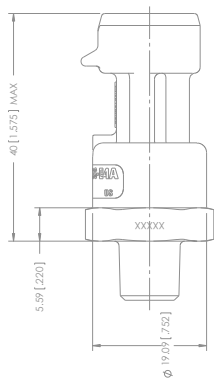

Main Features

Pressure Ranges	0 - 1 up to 0 - 70 Bar, 0 - 15 up to 0 - 1000 PSI
Pressure Connections	1/4-18 NPT (external), 1/8-27 NPT (external)
Electrical Connection	Packard Metri-Pack 15
Housing Material	Brass and 304 Stainless Steel (1.4301)
Output Signal	0.5 to 4.5 VDC

For further options, please see Main Options

Attributes

- Small Size (3/4" Hex)
- External Hex for Easy Installation
- Temperature Compensated
- Superior Long-Term Stability
- Low Power Consumption
- 36 VDC Over Voltage and Reverse Polarity Protection

Typical Applications

- Compressors
- Process Controls
- Instruments & Test Equipment
- Sterilizers
- Air Pressure
- Oil & Fuel Pressure
- Coolant Pressure
- Agricultural Equipment
- CNG & Natural Gas Engines

P500 - MAIN OPTIONS

Pressure Ranges

0 - 1 Bar	0 - 15 PSI
0 - 1.6 Bar	0 - 20 PSI
0 - 2.5 Bar	0 - 30 PSI
0 - 4 Bar	0 - 50 PSI
0 - 6 Bar	0 - 75 PSI
0 - 10 Bar	0 - 100 PSI
0 - 16 Bar	0 - 150 PSI
0 - 25 Bar	0 - 200 PSI
0 - 40 Bar	0 - 300 PSI
0 - 50 Bar	0 - 500 PSI
0 - 70 Bar	0 - 750 PSI
	0 - 1000 PSI

Pressure References

- Absolute
- Gage
- Sealed Gage (Referenced to 14.7 PSIA)

External Seal Material

- Fluorocarbon / Viton® (-25° to +125°C)
- Fluorosilicone (-40° to +125°C)
- Ethylene Propylene (-30° to 120°C)

Pressure Connections

- 1/4 - 18 NPT (Ext. Threads)
- 1/8 - 27 NPT (Ext. Threads)
- Stud End DIN 3852-B-G 1/4 (Ext. Threads)
- Tapped Hole DIN 3852-Y-G 1/4 (Int. Threads)
- 3/8 - 24 UNF-2A Per SAE J1926/2 (Ext. Threads)
- 3/8 - 24 UNF-2B Per SAE J1926/2 (Int. Threads)

Built-in Electrical Connections

- Packard Metri-Pack 150

* UL Certified pressures ranges: 0 - 1 Bar to 0 - 50 Bar [0 - 15 PSI to 0 - 750 PSI]

P528 Pressure Sensor for Refrigeration

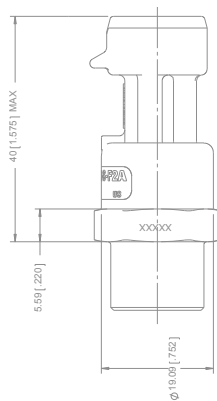

Main Features

Pressure Ranges	0 - 6 up to 0 - 70 bar and 0 - 100 up to 0 - 100 PSI
Pressure Connections	1/4"SAE Female Flare w/ Schrader Deflator 7/16"-20UNF-2A external thread 1/4"-18 NPT and 1/8"-27 NPT (external threads)
Electrical Connection	Packard Metri Pack 150
Housing Material	Brass or S304 Stainless Steel (1.4301)
Output Signal	0.5 - 4.5 VDC

For further options, please see Main Options

Attributes

- SAE female Pressure Connections with Built-in Schrader Deflator
- Low Power Consumption
- Outstanding Shock & Vibration Performance
- 36 VDC Over Voltage and Reverse Polarity Protection

Typical Applications

- High and Low Side Pressure Measurements in Refrigeration Systems
- Product Refrigeration
- Refrigerant Recovery
- Transport Refrigeration
- Environmental Test Equipment

P528 - MAIN OPTIONS

Pressure Ranges

0 - 6 Bar	0 - 100 PSI
0 - 10 Bar	0 - 150 PSI
0 - 16 Bar	0 - 300 PSI
0 - 25 Bar	0 - 500 PSI
0 - 40 Bar	0 - 600 PSI
0 - 50 Bar	0 - 750 PSI
0 - 70 Bar	0 - 1000 PSI

Pressure References

- Absolute
- Gage
- Sealed Gage (Referenced to 14.7 PSIA)

External Seal Material

- Neoprene (-30° to 120°C)
- Ethylene Propylene (-40° to +120°C)
- HNBR (-25° to +125°C)

Pressure Connections

- 1/4 - 18 NPT (Ext. Threads)
- 1/4 SAE Female Flare w/ Schrader Deflator (7/16 - 20 UNF-2B Int. Threads)
- 7/16 - 20 UNF-2A Per SAE J513f (Ext. Threads)
- 1/8 - 27 NPT (Ext. Threads)

Built-in Electrical Connections

- Packard Metri-Pack 150

* UL Certified pressures ranges: 0 - 1 Bar to 0 - 50 Bar [0 - 15 PSI to 0 - 750 PSI]

P265 Pressure Transducer

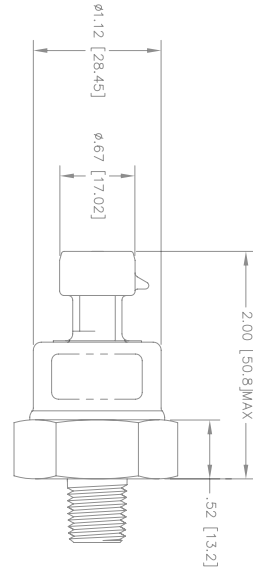

Main Features

Pressure Ranges	0 - 15 up to 0 - 1000 PSI
Pressure Connections	1/8-27 NPT, 1/4-18 NPT
Electrical Connection	Packard Metri-Pack 150
Housing Material	Stainless steel
Output Signal	0.5 - 4.5 VDC

For further options, please see Main Options

Attributes

- Dry Media
- Superior Long Term Stability
- Superior EMI/RFI Rejection
- Temperature Compensated
- Ten Million Cycle Life Expectancy
- Outstanding Shock & Vibration Performance

Typical Applications

- Steam Sterilizers
- Gasoline & Diesel Engines
- Natural Gas & CNG Engines
- Agricultural Chemical Equipment
- Hydraulic Systems
- Level Measurement
- Test Equipment
- Injection Molding
- Coolant Pressure
- Industrial Compressors

P265 - MAIN OPTIONS

Pressure Ranges

0 - 15 PSI	0 - 200 PSI
0 - 20 PSI	0 - 300 PSI
0 - 30 PSI	0 - 500 PSI
0 - 50 PSI	0 - 750 PSI
0 - 75 PSI	0 - 1000 PSI
0 - 100 PSI	
0 - 150 PSI	

Pressure References

- Absolute
- Gage
- Sealed Gage (Referenced to 14.7 PSIA)

External Seal Material

- Nitrile
- Neoprene
- Fluorocarbon
- Fluorosilicone
- Ethylene propylene

Pressure Connections

- 1/4 - 18 NPT (Ext. Threads)
- 3/8 - 24 UNF-2A (Male)
- 3/8 - 24 UNF-2B (Female)
- 1/8 - 27 NPT

Built-in Electrical Connections

- Packard Metri-Pack 150

PS312 Ceramic Capacitive Low Pressure Sensing Module

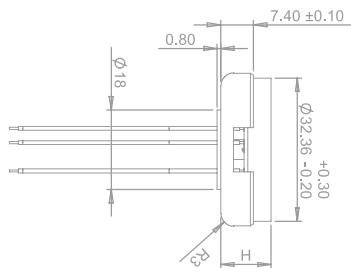
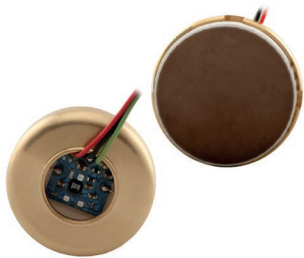

Main Features

Pressure Ranges	0 to 0.07 bar up to 0 to 20 bar (gage) 0 to 1 up to 0 to 20 bar (absolute)
Electrical Connection	3 isolated color coded wires
Housing Material	Brass Spacer
Output Signal	1 - 4 VDC, 0.5 - 4.5 VDC (at 100% pressure)

For further options, please see Main Options

Attributes

- Media Resistant
- Superior Long-Term Stability & Repeatability
- High Overpressure Capability
- Shock & Vibration Resistant

Typical Applications

- Industrial Pumps & Compressors
- Refrigeration
- Heating, Ventilation and Air-conditioning (HVAC)
- Process Controls
- Fuel Cells
- Water Management
- Hydraulics Systems

PS312 - MAIN OPTIONS

Pressure Ranges

0 - 0.70 barG	0 - 1 barA
0 - 0.75 barG	0 - 2 barA
0 - 1 barG	0 - 3.50 barA
0 - 2 barG	0 - 5 barA
0 - 3.50 barG	0 - 7 barA
0 - 5 barG	0 - 10 barA
0 - 7 barG	0 - 20 barA
0 - 10 barG	
0 - 20 barG	

Output

- 1 - 4 VDC at 100% Pressure
- 0.5 - 4.5 VDC at 100% Pressure

PS162 Ceramic Capacitive High Pressure Sensing Module

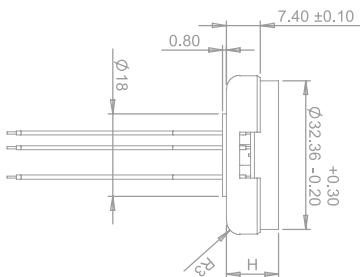
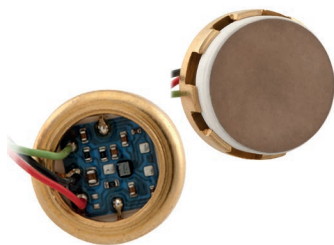

Main Features

Pressure Ranges	0 to 0.04 bar up to 0 to 60 bar (gage) 0 to 1 up to 0 to 60 bar (absolute)
Electrical Connection	3 isolated color coded wires
Housing Material	Brass Spacer
Output Signal	1 - 4 VDC, 0.5 - 4.5 VDC (at 0 - 100% pressure)

For further options, please see Main Options

Attributes

- Media Resistant
- Superior Long-Term Stability & Repeatability
- High Overpressure Capability
- Shock & Vibration Resistant

Typical Applications

- Industrial Pumps & Compressors
- Refrigeration
- Heating, Ventilation and Air-conditioning (HVAC)
- Process Controls
- Fuel Cells
- Water Management
- Hydraulics Systems

PS162 - MAIN OPTIONS

Pressure Ranges

0 - 0.40 barG	0 - 1 barA
0 - 1 barG	0 - 2 barA
0 - 2 barG	0 - 3.50 barA
0 - 3.50 barG	0 - 5 barA
0 - 5 barG	0 - 7 barA
0 - 7 barG	0 - 10 barA
0 - 10 barG	0 - 20 barA
0 - 20 barG	0 - 35 barA
0 - 35 barG	0 - 60 barA
0 - 60 barG	

Output

- 1 - 4 VDC at 100% Pressure
- 0.5 - 4.5 VDC at 100% Pressure

PE2000 OEM Pressure Sensor

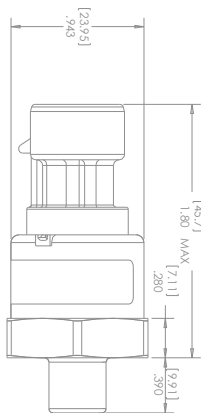

Main Features

Pressure Ranges	0 - 0.25 up to 0 - 25 bar 0 - 5 up to 0 - 300 PSI
Pressure Connections	1/8"-27 NPT, 1/4"-18 NPT
Electrical Connection	Packard Metri-Pack 150, DIN Bayonet 72585-A1-3.1-SN
Housing Material	Stainless Steel
Output Signal	0.5 - 4.5 VDC ratiometric

For further options, please see Main Options

Attributes

- Wet & Dry Media
- Superior Long Term Stability
- Superior EMI Protection
- Temperature Compensated
- Minimum Life Expectancy:
10 Million Cycles
- Outstanding Shock & Vibration
Performance

Typical Applications

- Compressors
- Instruments & Test
Equipment
- Hydraulic Systems
- Air, Oil, Fuel and Coolant
- Pressure
- Agricultural Equipment
- CNG & Natural Gas Engines

PE2000 - MAIN OPTIONS

Pressure Ranges

0 - 0.25 Bar*	0 - 5 PSI*	*in gage only
0 - 0.4 Bar*	0 - 10 PSI*	
0 - 0.6 Bar*	0 - 15 PSI*	
0 - 1 Bar*	0 - 20 PSI	
0 - 1.6 Bar	0 - 30 PSI	
0 - 2.5 Bar	0 - 50 PSI	
0 - 4 Bar	0 - 75 PSI	
0 - 6 Bar	0 - 100 PSI	
0 - 10 Bar	0 - 150 PSI	
0 - 16 Bar	0 - 200 PSI	
0 - 25 Bar	0 - 300 PSI	

Pressure References

- Absolute
- Gage
- Sealed Gage (0 PSI = 14.7 PSIA)

External Seal Material

- Silicone
- Nitrile
- Neoprene
- Fluorocarbon
- Fluorosilicone
- Ethylene Propylene

Pressure Connections

- 1/8-27 NPT
- 1/4-18 NPT

Built-in Electrical Connections

- Packard Metri-Pack 150
- DIN Bayonet 72585-A1-3.1-SN

P321 Wet Wet Differential Pressure Sensor



Main Features

Pressure Ranges	0 to 350 mbar
Housing Material	Polyetherimide
Bracket Material	Carbon Steel
Gasket Material	Fluorosilicone
Output Signal	0.5 VDC @ 0.0 mbarD to 4.5 VDC @ 350 mbarD

For further options, please see Main Options

Attributes

- Temperature Compensated
- Low Power Consumption
- Rugged Design
- High Temperature Performance
- Compatible with Harsh Environments & Exhaust Media

Typical Applications

- Exhaust Gas Recirculation (EGR)
- Diesel Particulate Filter (DPF)
- Chillers
- Differential Pressure for Natural
- Gas Power Generation
- Oil Differential Sensing on Compressors

P321 - MAIN OPTIONS

The P321 is a **customized product series** of Wet Wet Differential Pressure Sensors that use a 5 VDC input to measure the differential pressure between two pressure ports, providing a 0.5 to 4.5 VDC output proportional to pressure. Incorporating an oil-filled capacitive sense element, these sensors are able to withstand vacuum (negative) pressures as well as high common mode pressures. The large diaphragm protects these sensors from the accumulation of soot and other harsh materials.

Packaged in Ultem 2000 Series Plastic and using a carbon steel metal bracket as its mounting feature, the P321 is rugged and durable by design. It is temperature compensated to meet the accuracy requirements of the customer, and is rated to perform continuously at temperatures up to 125°C.

Specifically intended to withstand high common mode pressures, high vibration environments, and with its resistance to soot and other acidic media, the P321 pressure sensor delivers the optimal solution without compromising performance or reliability.

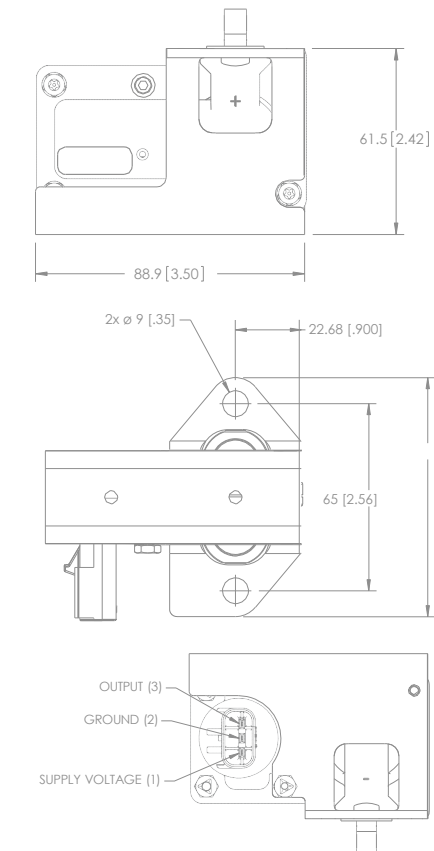

P6000 Remote Mount Miniature Pressure Sensor

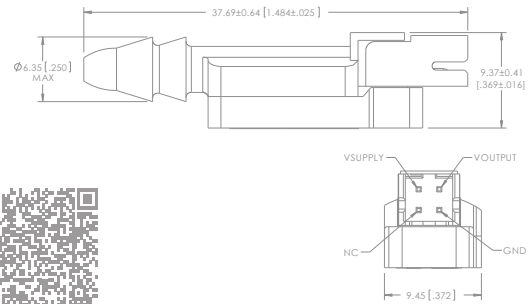

Main Features

Pressure Ranges	0 - 2.5 and 0 - 5 PSIG 0 - 15 to 0 - 100 PSIA or PSIG 0 - 200 and 0 - 500 mbarG 0-1 to 0-7 barG or barA
Pressure Connections	Barb for 3/16 ID tubing
Electrical Connection	Pin Header Pin Header with Mating Connector 12" Lead Wires
Housing Material	PET (30% glass lled)
Output Signal	0.5 - 4.5 VDC

For further options, please see Main Options

Attributes

- Rugged, Miniature Package
- Amplified, Temperature Compensated Linear Output
- Remote Mounting Option
- Custom Packaging and Pressure Ranges

Typical Applications

- Oxygen Concentrators
- Respirators
- Sleep Apnea
- Instrumentation
- Pneumatic Controls
- Robotics

P6000 - MAIN OPTIONS

Pressure Ranges

0 - 2.5 PSIG	0 - 200 mbarG
0 - 5 PSIG	0 - 500 mbarG
0 - 15 PSIG or PSIA	0 - 1 barG or barA
0 - 30 PSIG or PSIA	0 - 2 barG or barA
0 - 50 PSIG or PSIA	0 - 3.5 barG or barA
0 - 75 PSIG or PSIA	0 - 5 barG or barA
0 - 100 PSIG or PSIA	0 - 7 barG or barA

Pressure References

- Absolute
- Gage

External Seal Material

- Pin Header
- Pin Header with Mating Connector 12" Lead Wires

P4000 Hermetically Sealed Pressure Sensor

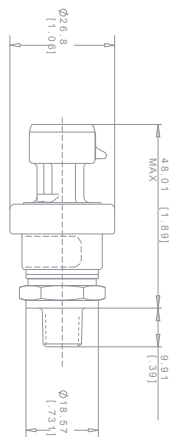

Main Features

Pressure Ranges	0-100 up to 0-5000 PSI
Pressure Connections	1/8-27 NPT, 1/4-18 NPT
Electrical Connection	Packard Metri-Pack 150
Housing Material	304 Stainless Steel
Output Signal	0.5 - 4.5 VDC

For further options, please see Main Options

Attributes

- Welded Stainless Steel Construction
- Stainless Steel Isolation Diaphragm
- Absolute or Sealed Gage Reference
- Low Power Consumption
- High Vibration Tolerance
- Outstanding EMI/RFI Protection

Typical Applications

- On & Off Highway Vehicle Hydraulic Systems
- Pressurized Tools
- Instruments
- Pneumatic Controls
- Refrigerant Control & Recovery

P4000 - MAIN OPTIONS

Pressure Ranges

0 - 100 PSI	0 - 1500 PSI
0 - 150 PSI	0 - 2000 PSI
0 - 200 PSI	0 - 2500 PSI
0 - 250 PSI	0 - 3000 PSI
0 - 300 PSI	0 - 3500 PSI
0 - 500 PSI	0 - 4000 PSI
0 - 600 PSI	0 - 4500 PSI
0 - 750 PSI	0 - 5000 PSI
0 - 1000 PSI	

Pressure References

- Absolute
- Sealed Gage

Output

- 0.5 - 4.5 VDC

External Seal Material

- None
- Nitrile

Pressure Connections

- 1/8 - 27 NPT
- 1/4 SAE Female Schrader Deflator
- 7/16 - 20 UNF SAE J1926/2
- 1/4 - 18 NPT

Built-in Electrical Connections

- Packard Metri-Pack 150
- Deutsch DT04 (3 pole)

P4055 Pressure Transducer

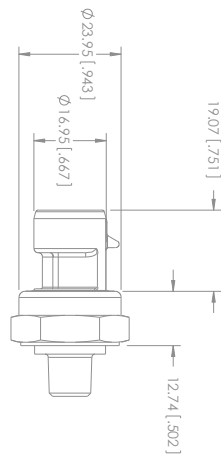

Main Features

Pressure Ranges	0-3 to 0-300 PSI
Pressure Connections	1/4"-18NPT, G1/4", M10x1, M12x1.5
Electrical Connection	Packard Metri-Pack 150
Housing Material	Brass
Output Signal	0.5 - 4.5 VDC

For further options, please see Main Options

Attributes

- Small Size
- Back-side PRT Configuration
- High Vibration Tolerance
- Superior EMI/RFI Performance
- Temperature Compensated

Typical Applications

- Pumps & Compressors
- Process Controls
- Filter Restriction
- Oil and Fuel Pressures
- Water & Level Management
- Test & Monitoring Equipment

P4055 - MAIN OPTIONS

Pressure Ranges

0 - 3	PSI	0 - 75	PSI
0 - 5	PSI	0 - 100	PSI
0 - 10	PSI	0 - 150	PSI
0 - 15	PSI	0 - 200	PSI
0 - 30	PSI	0 - 300	PSI
0 - 50	PSI		

Pressure References

- Absolute
- Gage
- Sealed Gage

External and Internal Seal Material

- Fluorosilicone

Pressure Connections

- 1/4-18 NPT
- M12 x 1.5-6g per ISO 6149
- M10 x 1-6g per ISO 6149
- 1/8-27 NPT
- Stud end per DIN 3852-A-G1/4 (sealing washer, not supplied)
- M14 x 1.5-6g er ISO 6149
- Stud end per DIN 3852-C-R1/4 (1/4-19 BSPT)
- 7/16-20UNF-2A
- M16 x 1.5-6g
- Stud end per DIN 3852-C-R1/8 (1/8-28 BSPT)

Built-in Electrical Connections

- Packard Metri-Pack 150

P4056 Pressure Transducer

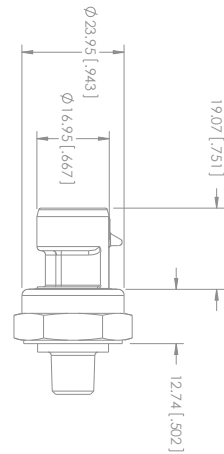

Main Features

Pressure Ranges	0-200 mBar up to 0-20 Bar
Pressure Connections	1/4"-18NPT, G1/4", M10x1, M12x1.5
Electrical Connection	Packard Metri-Pack 150
Housing Material	Brass
Output Signal	0.5 - 4.5 VDC

For further options, please see Main Options

Attributes

- Small Size
- High Vibration Tolerance
- Superior EMI/RFI Performance
- Temperature Compensated

Typical Applications

- Pumps & Compressors
- Process Controls
- Filter Restriction
- Oil and Fuel Pressures
- Water Management
- Test & Monitoring Equipment

P4056 - MAIN OPTIONS

Pressure Ranges

0 - 200 mBarG	0 - 7 Bar
0 - 300 mBarG	0 - 10 Bar
0 - 1 Bar	0 - 15 Bar
0 - 2 Bar	0 - 20 Bar
0 - 4 Bar	
0 - 5 Bar	

Pressure References

- Absolute
- Gage
- Sealed Gage

External and Internal Seal Material

- Fluorosilicone

Pressure Connections

- 1/4-18 NPT
- M12 x 1.5-6g per ISO 6149
- M10 x 1-6g per ISO 6149
- 1/8-27 NPT
- Stud end per DIN 3852-A-G1/4 (sealing washer, not supplied)
- M14 x 1.5-6g er ISO 6149
- Stud end per DIN 3852-C-R1/4 (1/4-19 BSPT) 7/16-20UNF-2A
- M16 x 1.5-6g
- Stud end per DIN 3852-C-R1/8 (1/8-28 BSPT)

Built-in Electrical Connections

- Packard Metri-Pack 150

P1J Digital Low Range Differential Pressure Sensor

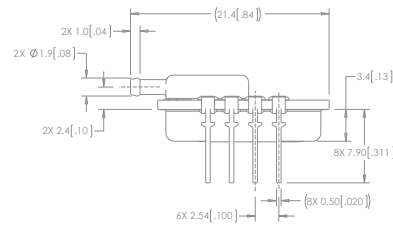
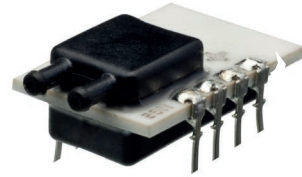

Main Features

Pressure Ranges	1, 2, 5, 10, ± 1 , ± 2 , and ± 5 in of H2O
Pressure Connections	1/8" diameter tube fitting with barb for 3/16" ID tubing
Electrical Connection	PCB solderable pin
Housing Material	PPS and Ceramic
Output Signal	SPI, and I2C

For further options, please see Main Options

Attributes

- Rugged Package
- EMI/RFI & ESD Protected
- Frequency Output Option (Consult Factory)
- Superior Output Signal Stability
- Connects to Standard PCB
- Socket Receptacles

Typical Applications

- Variable Air Volume Systems
- Filter Pressure Monitoring
- Duct Air Flow
- Modulated Furnace Controls
- Combustion Air Flow
- Gaseous Leak Detection

P1J - MAIN OPTIONS

Pressure Ranges

0-1"	H2O	0-2.5	mbar
+/- 1"	H2O	+/- 2.5	mbar
0-2"	H2O	0-5	mbar
+/- 2"	H2O	+/- 5	mbar
0-5"	H2O	0-12.5	mbar
+/- 5"	H2O	+/- 12.5	mbar
0-10"	H2O	0-25	mbar

Output

- SPI
- I2C, 28 Hex
- I2C, 38 Hex
- I2C, 48 Hex
- I2C, 58 Hex
- I2C, 68 Hex
- I2C, 78 Hex
- I2C, 88 Hex
- I2C, 98 Hex

Pressure Connections

- Tube Fitting with Barb

Built-in Electrical Connections

- PCB Terminal Pin

P1K Analog Low Range Differential Pressure Sensor

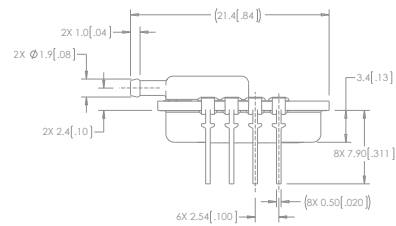
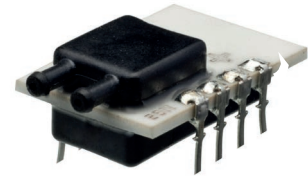

Main Features

Pressure Ranges	1, 2, 5, 10, ± 1 , ± 2 , and ± 5 in of H2O
Pressure Connections	1/8" diameter tube fitting with barb for 3/16" ID tubing
Electrical Connection	PCB solderable pin
Housing Material	PPS and Ceramic
Output Signal	0.25 - 4.0 VDC

For further options, please see Main Options

Attributes

- Rugged Package
- EMI/RFI & ESD Protected
- Frequency Output Option (Consult Factory)
- Superior Output Signal Stability
- Connects to Standard PCB
- Socket Receptacles

Typical Applications

- Variable Air Volume Systems
- Filter Pressure Monitoring
- Duct Air Flow
- Modulated Furnace Controls
- Combustion Air Flow
- Gaseous Leak Detection

P1K - MAIN OPTIONS

Pressure Ranges

0-1"	H2O	0-2.5	mbar
+/- 1"	H2O	+/- 2.5	mbar
0-2"	H2O	0-5	mbar
+/- 2"	H2O	+/- 5	mbar
0-5"	H2O	0-12.5	mbar
+/- 5"	H2O	+/-12.5	mbar
0-10"	H2O	0-25	mbar

Output

- 0.25 - 4.0 VDC

Pressure Connections

- Tube Fitting with Barb

Built-in Electrical Connections

- PCB Terminal Pin

P992 Low Range Differential Pressure Sensor

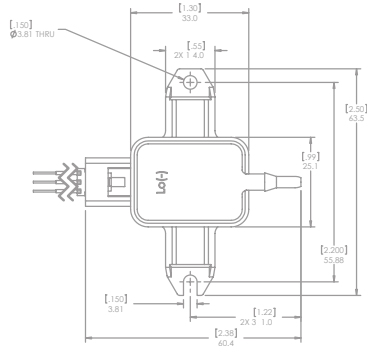

Main Features

Pressure Ranges	1, 2, 5, 10, ± 1 , ± 2 , and ± 5 in of H ₂ O
Pressure Connections	1/8" diameter tube fitting with barb for 3/16" ID tubing
Electrical Connection	PCB Mount
Housing Material	PET (30% glass filled)
Output Signal	0.25 - 4.0 VDC

For further options, please see Main Options

Attributes

- Rugged Package
- Mounting Congurations
- No Position Sensitivity
- EMI/RFI & ESD Protected
- Frequency Output Option
(Consult Factory)
- Superior Output Signal Stability

Typical Applications

- Variable Air Volume Systems
- Filter Pressure Monitoring
- Duct Air Flow
- Modulated Furnace Controls
- Combustion Air Flow
- Gaseous Leak Detection

P992 - MAIN OPTIONS

Pressure Ranges

0-1" H ₂ O	0-2.5 mbar
+/- 1" H ₂ O	+/- 2.5 mbar
0-2" H ₂ O	0-5 mbar
+/- 2" H ₂ O	+/- 5 mbar
0-5" H ₂ O	0-12.5 mbar
+/- 5" H ₂ O	+/- 12.5 mbar
0-10" H ₂ O	0-25 mbar

Mounting Configurations

- PCB Mount
- 3* Foot PCB (Compatible with Kavlico P892)
- 2 Foot PCB with lead wires

P993 Low Range Differential Pressure PCB Mount Sensor

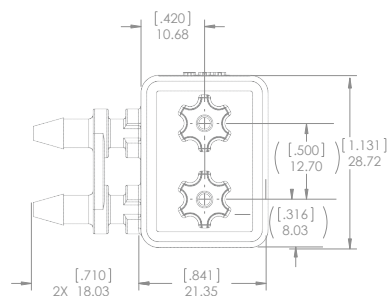

Main Features

Pressure Ranges	1, 2, 5, 10, ± 1 , ± 2 , and ± 5 inches of H ₂ O
Pressure Connections	1/8" diameter tube fitting with barb for 3/16" ID tubing
Electrical Connection	PCB Mount
Housing Material	PET (30% glass filled)
Output Signal	0.25 - 4.0 VDC

For further options, please see Main Options

Attributes

- Rugged PCB Mount Package
- Amplified Temperature
- Compensated Linear Output
- No Position Sensitivity
- EMI/RFI & ESD Protected
- Superior Output Signal Stability

Typical Applications

- Variable Air Volume Systems
- Filter Pressure Monitoring
- Duct Air Flow
- Modulated Furnace Controls
- Combustion Air Flow
- Gaseous Leak Detection

P993 - MAIN OPTIONS

Pressure Ranges

0-1" H ₂ O	0-2.5 mbar
+/- 1" H ₂ O	+/- 2.5 mbar
0-2" H ₂ O	0-5 mbar
+/- 2" H ₂ O	+/- 5 mbar
0-5" H ₂ O	0-12.5 mbar
+/- 5" H ₂ O	+/- 12.5 mbar
0-10" H ₂ O	0-25 mbar



ACCESSORIES

Mating Connector 18mm with NBR Gasket

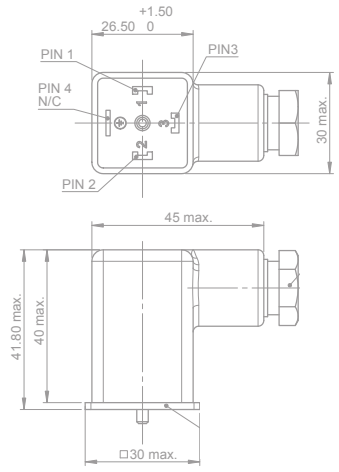

Mating Connector 9.4mm with NBR Gasket

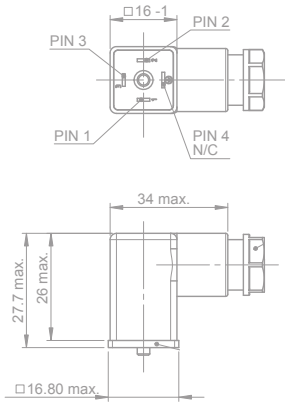

Mating Connector M12, RT-Angle

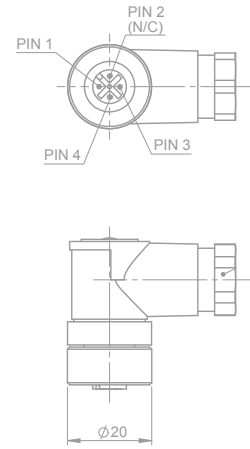

Mating Connector Packard Metri-Pack, Cable Assembly

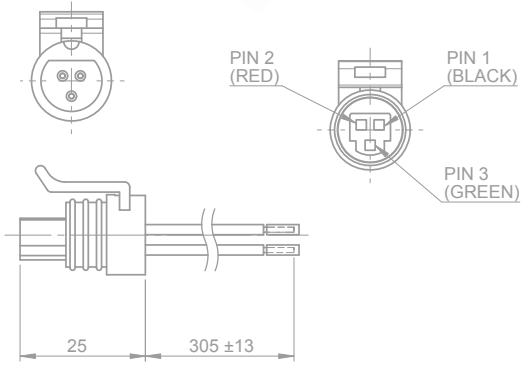

NOTES



- Manufacturing Facility
- Commercial Office

North America

Custom Sensors & Technologies (CST)
235 E. Main St., Suite 102A
Northville, MI 48167, USA
Phone: +1 (248) 465-0815
Fax: +1 (248) 465-0810
E-mail: pressure.sensors@kavlico.com

Europe

Custom Sensors & Technologies (CST)
Potsdamer Strasse 14
32423 Minden, Germany
Phone: +49 571 3859-0
Fax: +49 571 3859-119
E-mail: info@kavlico.de

China

Custom Sensors & Technologies (CST)
11th Floor, Chang Feng
International Tower, 89
Yunling Road (east), Putuo District
Shanghai - 200062, China
Phone: +86 (21) 8025 7166
Fax: +86 (21) 6107 1771
E-mail: china@cstsensors.com

India

Custom Sensors & Technologies (CST)
4th Floor, Trident Tower #23, 100 Feet
Ashoka
Pillar Road 2nd Block, Jayanagar,
Bangalore 560011, India
Phone: +91 80 4113-2204/05
Fax: +91 80 4113-2206
E-mail: india@cstsensors.com

South Korea

Custom Sensors & Technologies (CST)
14F, Kbiz DMC Tower, 189,
Seongam-ro, Mapo-gu,
Seoul, Korea 121-904
Phone: +82 2 2629-8312
Fax: +82 2 2630-9800
E-mail: korea@cstsensors.com

Distributed by:

© 2015 Kavlico. All rights reserved.
Kavlico's General Terms & Conditions apply and can be found on our website.